

**Road Planning and Design Manual
Edition 2: Volume 3**

**Supplement to Austroads Guide to Road Design
Part 3: Geometric Design**

November 2023



Copyright

© The State of Queensland (Department of Transport and Main Roads) 2023.

Licence



This work is licensed by the State of Queensland (Department of Transport and Main Roads) under a Creative Commons Attribution (CC BY) 4.0 International licence.

CC BY licence summary statement

In essence, you are free to copy, communicate and adapt this work, as long as you attribute the work to the State of Queensland (Department of Transport and Main Roads). To view a copy of this licence, visit: <https://creativecommons.org/licenses/by/4.0/>

Translating and interpreting assistance



The Queensland Government is committed to providing accessible services to Queenslanders from all cultural and linguistic backgrounds. If you have difficulty understanding this publication and need a translator, please call the Translating and Interpreting Service (TIS National) on 13 14 50 and ask them to telephone the Queensland Department of Transport and Main Roads on 13 74 68.

Disclaimer

While every care has been taken in preparing this publication, the State of Queensland accepts no responsibility for decisions or actions taken as a result of any data, information, statement or advice, expressed or implied, contained within. To the best of our knowledge, the content was correct at the time of publishing.

Feedback

Please send your feedback regarding this document to: tmr.techdocs@tmr.qld.gov.au

Relationship with Austroads Guide to Road Design – Part 3 (2021)

The Department of Transport and Main Roads has, in principle, agreed to adopt the standards published in the Austroads *Guide to Road Design (2021) Part 3: Geometric Design*.

When reference is made to other parts of the Austroads *Guide to Road Design*, Austroads *Guide to Traffic Management* or the Austroads *Guide to Road Safety*, the reader should also refer to Transport and Main Roads related manuals:

- *Road Planning and Design Manual (RPDM)*
- *Queensland Guide to Traffic Management (QGTM)*
- *Queensland Manual of Uniform Traffic Control Devices (Queensland MUTCD)*
- *Traffic and Road Use Management Manual (TRUM)*.

Where a section does not appear in the body of this supplement, the Austroads *Guide to Road Design – Part 3* criteria is accepted unamended.

This supplement:

1. has precedence over the Austroads *Guide to Road Design – Part 3* when applied in Queensland
2. details additional requirements, including *accepted with amendments* (additions or differences), *new* or *not accepted*.
3. has the same structure (section numbering, headings and contents) as Austroads *Guide to Road Design – Part 3*.

The following table summarises the relationship between the Austroads *Guide to Road Design – Part 3* and this supplement using the following criteria:

Accepted	Where a section does not appear in the body of this supplement, the Austroads <i>Guide to Road Design – Part 3</i> is accepted.
Accepted with amendments	Part or all of the section has been accepted with additions and/or differences.
New	There is no equivalent section in the Austroads Guide.
Not accepted	The section of the Austroads Guide is not accepted.

Austroads Guide to Road Design – Part 3	RPDM relationship
1 Introduction	
1.1 Purpose	Accepted
1.2 Scope of this Part	Accepted
1.3 Design Criteria in Part 3	Accepted with amendments
1.4 Objectives of Geometric Design	Accepted
1.5 Road Safety	Accepted
1.6 Design Process	Accepted

Austrroads Guide to Road Design – Part 3	RPDM relationship
<u>2 Fundamental Considerations</u>	
2.1 General	Accepted
2.2 Design Parameters	Accepted with amendments
<u>3 Speed Parameters</u>	
3.1 General	Accepted with amendments
3.2 Terminology	Accepted with amendments
3.3 Operating Speeds on Urban Roads	Accepted with amendments
3.4 Operating Speeds on Rural Roads	Accepted
3.5 Determining Desired Speed	Accepted
3.6 Determining Operating Speeds Using the Operating Speed Model	Accepted with amendments
3.7 Operating Speed of Trucks	Accepted with amendments
3.8 Operating Speeds for Temporary Works (Including Side Tracks)	Accepted
<u>4 Cross-section</u>	
4.1 General	Accepted with amendments
4.2 Traffic Lanes	Accepted with amendments
4.3 Shoulders	Accepted with amendments
4.4 Verge	Accepted with amendments
4.5 Batters	Accepted with amendments
4.6 Roadside Drainage	Accepted with amendments
4.7 Medians	Accepted with amendments
4.8 Footpaths	Accepted
4.9 Bicycle Lanes	Accepted with amendments
4.10 High Occupancy Vehicle (HOV) Lanes	Accepted
4.11 On-street Parking	Accepted with amendments
4.12 Service Roads, Outer Separators and Footpaths	Accepted with amendments
4.13 Bus Stops	Accepted with amendments
4.14 Roads in Expansive Soils in Western Queensland	New
4.15 Roads in Rain Forest (including the Wet Tropics)	New
<u>5 Sight Distance</u>	
5.1 General	Accepted
5.2 Sight Distance Parameters	Accepted with amendments
5.3 Stopping Sight Distance (SSD)	Accepted with amendments
5.4 Sight Distance on Horizontal Curves	Accepted with amendments
5.5 Sight Distance Requirements on Horizontal Curves with Roadside Barriers / Wall / Bridge Structures	Accepted with amendments
5.6 Overtaking Sight Distance	Accepted with amendments
5.7 Manoeuvre Sight Distance	Accepted
5.8 Intermediate Sight Distance	Accepted with amendments
5.9 Headlight Sight Distance	Accepted
5.10 Horizontal Curve Perception Sight Distance	Accepted

Austrroads Guide to Road Design – Part 3	RPDM relationship
5.11 Other Restrictions to Visibility	Accepted
6 Coordination of Horizontal and Vertical Alignment	
6.1 Principles	Accepted
6.2 Safety Considerations	Accepted with amendments
6.3 Aesthetic Considerations	Accepted with amendments
6.4 Drainage Considerations	Accepted with amendments
7 Horizontal Alignment	
7.1 General	Accepted with amendments
7.2 Horizontal Alignment Design Procedure	Accepted
7.3 Tangents	Accepted
7.4 Circular Curves	Accepted with amendments
7.5 Types of Horizontal Curves	Accepted with amendments
7.6 Side Friction and Minimum Curve Size	Accepted with amendments
7.7 Superelevation	Accepted with amendments
7.8 Curves with Adverse Crossfall	Accepted with amendments
7.9 Pavement Widening on Horizontal Curves	Accepted with amendments
7.10 Curvilinear Alignment Design in Flat Terrain	Accepted with amendments
8 Vertical Alignment	
8.1 General	Accepted with amendments
8.2 Vertical Controls	Accepted with amendments
8.3 Grading Procedure	Accepted with amendments
8.4 Grading Point	Accepted with amendments
8.5 Grades	Accepted with amendments
8.6 Vertical Curves	Accepted with amendments
8.7 Earthworks	Accepted
9 Auxiliary Lanes	
9.1 General	Accepted
9.2 Types of Auxiliary Lanes	Accepted
9.3 Speed Change Lanes	Accepted
9.4 Overtaking Lanes	Accepted with amendments
9.5 Climbing Lanes	Accepted with amendments
9.6 Slow Vehicle Turnouts	Accepted
9.7 Descending Lanes	Accepted
9.8 Carriageway Requirements	Accepted
9.9 Geometric Requirements	Accepted with amendments
10 Bridge Considerations	
10.1 General	Accepted
10.2 Cross-section	Accepted with amendments
10.3 Horizontal Geometry	Accepted
10.4 Vertical Geometry	Accepted with amendments

Austrroads Guide to Road Design – Part 3		RPDM relationship
<u>References</u>		
References		Accepted with amendments
<u>Appendices</u>		
Appendix A	Extended Design Domain (EDD) and Design Exception (DE) and Potential Mitigation Strategies for Geometric Road Design	Accepted with amendments
Appendix B	Mid-block Treatments for Safe System Speeds	Not Accepted
Appendix C	Emergency Aircraft Runway Strips	Accepted
Appendix D	Speed Parameter Terminology	Accepted
Appendix E	Example Calculation of the Operating Speed Model	Accepted
Appendix F	Narrow Median Treatments with Wire Rope Safety Barrier (WRSB)	Accepted
Appendix G	Guidance for Wide Centre Line Treatments (WCLT)	Not accepted
Appendix H	Flow Charts and Table for Determining Stopping Sight Distance Requirements for Curves with Barriers	Accepted
Appendix I	Theory of Movement in a Circular Path	Accepted
Appendix J	Reverse Curves	Accepted
Appendix K	Transition Curves (Spirals)	Accepted
Appendix L	Vertical Curve Curvature Formulae	Accepted
<u>Commentaries</u>		
Commentary 1		Accepted
Commentary 2		Accepted
Commentary 3		Accepted with amendments
Commentary 4		Accepted
Commentary 5		Accepted
Commentary 6		Accepted
Commentary 7		Accepted
Commentary 8		Accepted
Commentary 9		Accepted
Commentary 10		Accepted
Commentary 11		Accepted
Commentary 12		Accepted
Commentary 13		Accepted
Commentary 14		Accepted
Commentary 15		Accepted
Commentary 16		Accepted
Commentary 17		Accepted
Commentary 18		Accepted
Commentary 19		Accepted

Austroads Guide to Road Design – Part 3

RPDM relationship

Commentary 20

Accepted

Commentary 21

Accepted

Commentary 22

Accepted

Contents

- 1 Introduction 1**
- 1.3 Design criteria in Part 3 1
- 2 Fundamental considerations 1**
- 2.2 Design parameters 1
 - 2.2.6 *Alignment controls* 1
 - 2.2.7 *Design vehicle* 1
 - 2.2.8 *Use of roads as emergency aircraft runway strips* 1
 - 2.2.9 *Environmental considerations* 1
 - 2.2.11 *Drainage* 1
 - 2.2.12 *Utility services* 1
- 3 Speed parameters 2**
- 3.1 General 2
- 3.2 Terminology 2
 - 3.2.1 *Posted speed limit* 2
- 3.3 Operating speeds on urban roads 2
 - 3.3.1 *Freeways (access controlled roads)* 2
- 3.6 Determining operating speeds using the operating speed model 2
 - 3.6.1 *General* 2
 - 3.6.4 *Car deceleration on curves graph* 2
 - 3.6.5 *Section operating speeds* 3
 - 3.6.6 *Use of operating speed in the design of rural roads* 3
- 3.7 Operating speed of trucks 4
- 4 Cross-section 4**
- 4.1 General 4
 - 4.1.2 *Consideration of staged development* 5
 - 4.1.3 *Widening of existing roads* 5
- 4.2 Traffic lanes 6
 - 4.2.2 *Road crossfall* 6
 - 4.2.3 *Crown lines* 6
 - 4.2.4 *Traffic lane widths* 7
 - 4.2.5 *Urban road widths* 8
 - 4.2.6 *Rural road widths* 8
- 4.3 Shoulders 10
 - 4.3.2 *Width* 10
 - 4.3.3 *Shoulder sealing* 11
- 4.4 Verge 12
 - 4.4.1 *Verge widths* 12
- 4.5 Batters 12
 - 4.5.1 *Benches* 14
 - 4.5.3 *Earth bunds or mounds* 14
 - 4.5.4 *Batter slope treatment* 14
 - 4.5.5 *Rock fall protection* 17
- 4.6 Roadside drainage 17
 - 4.6.1 *Table drains* 17
 - 4.6.2 *Catch drains* 18
 - 4.6.3 *Median drains* 19
 - 4.6.4 *Kerb and channel* 20
 - 4.6.5 *Dykes and batter drains* 21

4.6.6	<i>Access chambers</i>	21
4.6.7	<i>Floodways</i>	21
4.7	<i>Medians</i>	22
4.7.1	<i>Median treatments</i>	22
4.7.2	<i>Median width</i>	22
4.7.6	<i>Median surfacing</i>	24
4.9	<i>Bicycle lanes</i>	24
4.9.1	<i>General</i>	24
4.9.4	<i>Cross-section and clearances</i>	24
4.9.5	<i>Separated bicycle lanes</i>	24
4.9.6	<i>Contra-flow bicycle lanes</i>	24
4.9.10	<i>Bicycle / car parking lanes</i>	25
4.9.11	<i>Wide kerbside lanes</i>	25
4.11	<i>On-street parking</i>	25
4.11.2	<i>Parallel parking</i>	25
4.12	<i>Service roads, outer separators and footpaths</i>	25
4.12.1	<i>Service roads</i>	25
4.12.2	<i>Outer separator</i>	26
4.12.3	<i>Urban border</i>	26
4.13	<i>Bus stops</i>	26
4.13.2	<i>Urban</i>	26
4.14	<i>Roads in expansive soils in Western Queensland</i>	26
4.15	<i>Roads in rainforest (including the wet tropics)</i>	28
5	<i>Sight distance</i>	29
5.2	<i>Sight distance parameters</i>	29
5.2.3	<i>Longitudinal deceleration</i>	29
5.3	<i>Stopping Sight Distance (SSD)</i>	29
5.3.1	<i>Car stopping sight distance</i>	29
5.3.2	<i>Truck stopping sight distance</i>	29
5.4	<i>Sight distance on horizontal curves</i>	29
5.4.1	<i>Benching for visibility on horizontal curves</i>	29
5.5	<i>Sight distance requirements on horizontal curves with roadside barriers / wall / bridge structures</i> 30	
5.6	<i>Overtaking sight distance</i>	30
5.6.1	<i>General</i>	30
5.6.4	<i>Determination of percentage of road providing overtaking</i>	30
5.8	<i>Intermediate sight distance</i>	31
6	<i>Coordination of horizontal and vertical alignment</i>	32
6.2	<i>Safety considerations</i>	32
6.3	<i>Aesthetic considerations</i>	33
6.3.1	<i>Coincident horizontal and vertical curves</i>	33
6.3.4	<i>Skyline cuts</i>	33
6.4	<i>Drainage considerations</i>	34
7	<i>Horizontal alignment</i>	34
7.1	<i>General</i>	34
7.4	<i>Circular curves</i>	35
7.4.1	<i>Horizontal curve equation</i>	35
7.5	<i>Types of horizontal curves</i>	35

7.5.1	<i>Compound curves</i>	35
7.5.2	<i>Broken back curves</i>	35
7.5.4	<i>Transition curves</i>	35
7.6	Side friction and minimum curve size	36
7.7	Superelevation	37
7.7.3	<i>Maximum value of superelevation</i>	37
7.7.6	<i>Length of superelevation development</i>	37
7.7.10	<i>Positioning of superelevation runoff without transitions</i>	37
7.7.13	<i>Development of superelevation to avoid drainage problems</i>	38
7.8	Curves with adverse crossfall	39
7.9	Pavement widening on horizontal curves	41
7.10	Curvilinear alignment design in flat terrain	41
7.10.1	<i>Theoretical considerations</i>	41
8	Vertical alignment	41
8.1	General	41
8.2	Vertical controls	42
8.2.1	<i>General</i>	42
8.2.3	<i>Flood levels or water table</i>	42
8.2.4	<i>Vertical clearances</i>	42
8.2.7	<i>Vehicle clearances</i>	42
8.3	Grading procedure	42
8.4	Grading point	43
8.4.2	<i>Divided roads</i>	43
8.5	Grades	44
8.5.1	<i>General</i>	44
8.5.3	<i>Maximum grades</i>	44
8.5.4	<i>Length of steep grades</i>	44
8.5.5	<i>Steep grade considerations</i>	45
8.5.6	<i>Minimum grades</i>	45
8.6	Vertical curves	45
8.6.3	<i>Crest vertical curves</i>	45
8.6.4	<i>Sag vertical curves</i>	45
8.6.6	<i>Reverse / compound / broken back vertical curves</i>	45
8.6.7	<i>Minimum length of vertical curves</i>	46
9	Auxiliary lanes	46
9.4	Overtaking lanes	46
9.4.1	<i>General</i>	46
9.5	Climbing lanes	50
9.5.2	<i>Warrants</i>	50
9.9	Geometric requirements	50
9.9.1	<i>Starting and termination points</i>	50
9.9.2	<i>Tapers</i>	50
10	Bridge considerations	51
10.2	Cross-section	51
10.4	Vertical geometry	51
	References	52
	Appendix A - Extended Design Domain (EDD) and design exception and potential mitigation strategies for geometric road design	54

A.1	General	54
A.2	EDD and design exception cross-section widths.....	54
	A.2.1 <i>Urban road widths</i>	54
	A.2.2 <i>Rural two-lane two-way road widths</i>	55
	A.2.3 <i>Design exceptions for rural carriageway widths</i>	56
A.3	EDD for stopping sight distance	59
	A.3.3 <i>Vertical height parameters</i>	59
	A.3.7 <i>Shoulder / traversable widths and manoeuvre times</i>	59
	A.3.8 <i>EDD crest vertical curve size</i>	59
A.4	EDD for horizontal curves with adverse superelevation.....	63
A.5	Offset crown lines	63
	A.5.1 <i>Crossfall configuration and crown lines on side slopes</i>	63
	A.5.2 <i>Widening two-lane roads – offset crown</i>	63
A.6	Development of superelevation to avoid drainage problems	65
Appendix G – Guidance for Wide Centre Line Treatments (WCLT)		67
G.1	Purpose.....	67
G.2	Background and objective	67
G.3	Application	68
G.4	Dimensions and design of WCLT	68
	G.4.1 <i>Minimum length of WCLT</i>	68
	G.4.2 <i>Retrofitting WCLT to seals wider than specified for NDD or EDD</i>	70
G.5	WCLT at intersections	70
G.6	WCLT over narrow structures.....	74
	G.6.1 <i>Single narrow structure</i>	74
	G.6.2 <i>Successive narrow structures</i>	74
G.7	WCLT at overtaking lanes / climbing lanes	77
G.8	WCLT signage and ATLM requirements	78
	G.8.1 <i>Signs</i>	78
G.9	Design exceptions (departures).....	78
G.10	Widening to incorporate a WCLT.....	79
Commentary 3.....		80

Tables

Table 4.2.6(a) – Very low volume (< 250 vpd) rural road minimum widths (m) – Normal Design Domain	9
Table 4.2.6(b) – Minimum single carriageway rural road widths (m) – normal design domain.....	10
Table 4.3.2 – Shoulder width requirements to support cycling on sealed roads in rural areas with an 80+ km/h posted speed limit.....	11
Table 4.5 – Planning guidance for selecting batter slope based on soil type	13
Table 7.1 – Typical minimum radius for planning purposes.....	34
Table 7.6 – Maximum side friction factors for unsealed roads.....	36

Table 7.8 - Motorways and high-speed rural roads – Desirable minimum horizontal curve radii that can have adverse crossfall (based on 3% crossfall).....	40
Table A.2.2 – Minimum single carriageway rural road widths (m) – extended design domain.....	56
Table A.2.3(a) – Examples of carriageway widths (design exceptions) for passing lane sections (existing formations)	57
Table A.2.3(b) – Definitions of access levels	58
Table A.3.8.1 – Manoeuvre distances and K values – potential justification for design exceptions	60
Table G.4.1(a) – WCLT dimensions and ATLM application.....	68
Table G.4.1(b) – Normal design domain cross section for a WCLT – two-lane, two-way roads	69
Table G.4.1(c) – Extended design domain cross section for a WCLT – two-lane, two-way roads	69

Figures

Figure 4.2.3 – Rounding across the crown line	6
Figure 4.2.4 – Design lane widths	7
Figure 4.5.4(a) – Batter slope treatments.....	15
Figure 4.5.4(b) – Transition of batters from bank to cutting	15
Figure 4.5.4(c) – Treatment of cut batters for revegetation.....	16
Figure 4.6.1 – Typical table drain details.....	18
Figure 4.6.2 – Typical catch drains	19
Figure 4.14 – Desirable cross section elements for expansive soil lane	27
Figure 5.6.4 – Calculation of overtaking zones	30
Figure 5.8 – Restricted visibility widening application to vertical curves.....	32
Figure 6.3.1 – The optical summit	33
Figure 7.5.4 – Introducing transitions onto existing curves without transition.....	36
Figure 7.7.10 – Superelevation development for broken back curves.....	38
Figure 8.4.2 – Grading point process for divided roads	43
Figure 9.4.1(A) – Overtaking lanes and accesses or turnouts on right.....	48
Figure 9.4.1(B) – Flow Chart – Overtaking lanes and accesses or turnouts on right	49
Figure A.5.2 – Development of offset crown	65
Figure G.2 – WCLT with ATLM	67
Figure G.5(a) – WCLT at channelised right turn intersections.....	72
Figure G.5(b) – WCLT at basic right turn intersections and private property entrances.....	73
Figure G.5(c) – WCLT to double barrier line transition at right turn intersections.....	74

Figure G.6.2(a) – WCLT transition at a narrow structure (Not to scale) 75
Figure G.6.2(b) – WCLT transition at successive narrow structures (Not to scale) 76
Figure G.7 – WCLT treatment at overtaking / climbing lanes (Not to scale) 77

1 Introduction

1.3 Design criteria in Part 3

Addition

Guidance on the use of values outside of the Normal Design Domain (NDD) should be undertaken in accordance with the Transport and Main Roads *Road Planning and Design Manual* (RPDM) Volume 3, Part 1, and Appendix A of the relevant part.

2 Fundamental considerations

2.2 Design parameters

2.2.6 Alignment controls

Addition

Speed groups are groupings of the approach speeds into 5 km/h or 10 km/h bands and used as the basis for an expanded operating speed model (Austroads 2013).

2.2.7 Design vehicle

Addition

Additional information regarding heavy vehicle route maps and restrictions can be obtained from <https://www.tmr.qld.gov.au/business-industry/Heavy-vehicles/Heavy-vehicle-route-maps-and-restrictions>. The assessment of routes for multi combination vehicles is to be undertaken in accordance with the Transport and Main Roads *Route Assessment for Multi-Combination Vehicles (MCV) and Performance Based Standards (PBS) Vehicles in Queensland Guideline*.

2.2.8 Use of roads as emergency aircraft runway strips

Addition

The content of this section is to be considered informative. The need for and the technical requirements for designing and constructing a road to operate as an emergency runway strip should in the first instance be established in consultation with the department and other relevant stakeholders.

2.2.9 Environmental considerations

Addition

In addition, the Transport and Main Roads requirements relating to Environment Management shall be applied. These environmental technical publications can be obtained from <https://www.tmr.qld.gov.au/business-industry/Technical-standards-publications>.

2.2.11 Drainage

Difference

Drainage criteria is covered in the Transport and Main Roads *Road Drainage Manual* (RDM), which has precedence over the Austroads *Guide to Road Design – Part 5, 5A and 5B*.

2.2.12 Utility services

Addition

In addition, the Transport and Main Roads requirements relating to utility services within corridors for state-controlled roads shall be applied. Reference should be made to Transport and Main Roads

Technical Note 163 *Third Party Utility Infrastructure Installation in State-Controlled Roads Technical Guidelines*.

3 Speed parameters

3.1 General

Addition

Drivers' expectations of the need to reduce speed approaching curves is based on the visual information of the roadway geometry (for example radii of the horizontal curves and roadway widths) to control the speed and position of their vehicle on the roadway. When a decrease in driver alertness or an increase in driver workload occurs, there is an increased chance of a driver making a mistake. This in turn increases the chance of a crash occurring. This may occur on roadways that contain unexpected geometric features which may require a large change in speed and/or direction. Designers should ensure that roads are designed so that drivers can readily choose the required safe speed and position of their vehicles.

3.2 Terminology

3.2.1 Posted speed limit

Addition

Posted speeds should be developed in conjunction with the project development and the requirements of Transport and Main Roads Queensland *Manual of Uniform Traffic Control Devices* (Queensland MUTCD). Posted speeds should be credible to increase the probability of compliance.

3.3 Operating speeds on urban roads

Addition

With respect to the 3rd paragraph and associated bullet points, this approach is based on data and experience from Victoria. Any proposal to adopt a similar approach in Queensland must be supported by measured speed data specific to the site in question.

Table 3.1 of Austroads *Guide to Road Design – Part 3* is to be considered informative only. Speed limits in Queensland are set in accordance with the Transport and Main Roads Queensland MUTCD.

3.3.1 Freeways (access controlled roads)

Addition

The standard term used for 'freeways' in Queensland is 'motorway'.

3.6 Determining operating speeds using the operating speed model

3.6.1 General

Addition

The Transport and Main Roads software package *OSRoad* may be used to assess operating speed.

3.6.4 Car deceleration on curves graph

Difference

The 2nd dot point regarding 'the length of the curve or straight' is not needed to use Austroads *Guide to Road Design – Part 3*, Figure 3.7.

The final sentence in Section 3.6.4 of Austroads *Guide to Road Design – Part 3* is replaced with the following:

In the case of existing roads where the alignment is unable to be altered, a design exception review should be undertaken as outlined in the Transport and Main Roads RPDM Volume 3, Part 1 to establish if retaining existing sub-standard geometry can be justified. The use of signage to inform drivers of the restricted speeds provided by the alignment may not always result in an acceptable approach.

3.6.5 Section operating speeds

Difference

The Range of radii in Section (m) for 530+ row of information in Table 3.4 of Austroads *Guide to Road Design – Part 3* is replaced with the following three rows:

Range of Radii in Section (m)	Single Curve Section Radius (m)	Section Operating Speed (km/h)
530 - 670	600	110
*	700	115
*	800	120

* Treat each curve as a separate curve

Addition

Identification of sections

The following is added to the 4th paragraph:

While straights shorter than 200 m by themselves have no impact on vehicle operating speed, there can be impacts where acceleration occurs on adjacent elements and the total length of acceleration occurs over a length greater than 200 m. For example, on an alignment with an extremely large radius (> 600 m) with a curve length = 180 m adjacent to a short straight of length = 60 m, acceleration will occur on both of these elements as the total length is greater than 200 m.

3.6.6 Use of operating speed in the design of rural roads

Addition

The application of the operating speed model is only applicable on fully sealed roads.

Three additional new dot points are added to this section between the 6th and 7th dot points of Austroads *Guide to Road Design - Part 3*.

- For high speed roads, where the previous road alignment allows drivers to continuously achieve the desired speed for a duration of 15 minutes or more, the maximum difference in speed on the first section should be no more than 5 km/h. This is due to driver alertness and the amount of retained visual information of the roadway reducing after prolonged periods at high speed.
- It is desirable to provide a level of consistency through containing operating speeds within a 20 km/h range. Greater ranges of operating speed only gain higher driver acceptance when there are factors besides curvature that make the need for a lower operating speed obvious.

- Increases in side friction are considered to be a secondary control because drivers select their speed through their perception of the horizontal curvature. However, large increases in side friction demand, above what drivers have become accustomed to, can lead to a change in vehicle response not anticipated by some drivers. These can be particularly hazardous for motorcyclists as they can have difficulty in maintaining control through sudden change in side friction demand.

Limits to changes in side friction demand are therefore a desirable secondary control for ensuring geometric consistency. Guidelines for limiting the increase in side friction from one curve to the next are as follows:

- Desirable maximum increase from one horizontal curve to the next is 25% when the side friction factor on the latter curve is greater than 0.12.
- Lower side friction factors occur where a curve has a 'generous' radius for its design speed. This can occur in a section of road with a lower operating speed, and hence design speed due to previous curvature. In these cases, an increase in side friction greater than 25% can be accepted. However, it will be necessary to check any increase in side friction between the following curve and any curves prior to the 'generous' radius curve to check the side friction demand against the level to which drivers have become accustomed.
- Sections of road that involve a reduction in desired speed, may involve larger increases in side friction. In these cases, measures should be taken to alert the driver to the reduction in desired speed and the need for increases in side friction.

The 8th dot point in this section of *Austroads Guide to Road Design – Part 3* provides an example relating to sight distance in steep country. In this case where it may be impractical to achieve sight distance requirements in steep country, the recommended treatment is considered to be an Extended Design Domain (EDD) solution. The procedures for design, evaluation and approval of EDD must be followed in this case.

3.7 Operating speed of trucks

Addition

The Transport and Main Roads *VehSim* software may be used to help predict the speed of trucks, particularly on significant grades.

4 Cross-section

4.1 General

Difference

The 1st sentence in the 1st paragraph of *Austroads Guide to Road Design – Part 3* is replaced with the following (additional text is underlined):

The type of cross-section to be used in the development of any road project, and the variations in cross section along the length of the design, depends on:

Addition

The following dot points are added to the list of points under the 1st paragraph of this section of *Austroads Guide to Road Design – Part 3*.

- a balance between construction, maintenance and operating (including crash) costs
- the roadside environment and roadside furniture (refer to Transport and Main Roads RPDM Volume 3, Part 6 and Part 6B).

The following paragraph is added to the 4th paragraph of this section of *Austroads Guide to Road Design – Part 3*.

The cross-sectional design process shown in Figure 4.1 of *Austroads Guide to Road Design – Part 3* forms part of the overall design process. The considerable degree of inter-dependence between design elements needs to be recognised and this flowchart therefore represents a part of a flow process for the full design which is also iterative. As an example, decisions on shoulder width should be made considering the available sight distance due to vertical and horizontal alignment, the pavement surface treatment, adjoining travel lane widths, predicted traffic volumes and composition, and landscape elements.

The following is added at the end of this section of *Austroads Guide to Road Design – Part 3*.

The cost of the pavement, and its wearing surface, is often one of the most significant cost factors in a road project. The designer should therefore ensure that pavement width adopted is appropriate and optimised for the circumstances as small cross-section increases can add significantly to the project cost.

4.1.2 Consideration of staged development

Addition

In addition to staged design considering future road traffic requirements (i.e. estimated AADT), designers should also ensure that the design allows for future roadside infrastructure (e.g. edge or median safety barriers, new cycling provision etc.).

4.1.3 Widening of existing roads

There is no equivalent Section 4.1.3 in *Austroads Guide to Road Design – Part 3*.

New

Where improvements are designed for existing roads, particular attention is required when considering widening of the road cross-section. Adoption of dimensions that require widening of the formation may result in a large increase in the cost of the work, particularly on high embankments or in deep cuts. However once widening of the formation is accepted, marginal further increases in dimensions may not represent a significant increase in the total cost, particularly in flatter terrain.

The following factors are to be taken into consideration when widening of the road is proposed:

- Widening of the pavement by less than 1.9 m is often not practical due to the standard size of plant. Narrower widening typically entails construction wider than required and then cut back or the use of smaller less efficient equipment.
- Widening may be required in the following circumstances to address either current requirements or future works in the short-medium term:
 - to allow increase in pavement heights
 - to rectify cross section width deficiency
 - to allow the installation of road safety barriers (edge or median).

- Where the existing road has flatter batters, sliver widening is more practical as machinery can work longitudinally along the slope of the batter or transversely on the batter.
- Widening between 1.2 m and 1.9 m can be more practical in urban areas, due to surrounding constraints and the use of pedestrian path rollers.

In developing widening projects, designers should consider and examine the cost of alternatives to ensure that the most cost-effective solution is adopted.

If reconstruction of the road requires formation widening, the extent of the widening should be made sufficient to cover at least the next round of rehabilitation / overlay, unless there are strong economic reasons not to do so. The width of the pavement and surfacing provided initially does not need to extend to the formation edges.

4.2 Traffic lanes

4.2.2 Road crossfall

Addition

Crossfalls steeper than those listed in Table 4.2 of Austroads *Guide to Road Design – Part 3* should be applied with caution as they can result in larger vehicles tracking closer to the edge of the pavement.

On routes frequented by high loads, the maximum sustained crossfall should not exceed 4%. Local increases to 6% are acceptable, but these should only be used in highly constrained situations and only over short sections to prevent destabilisation of high vehicles.

Where steeper crossfalls are used, the working width of high vehicles to poles, walls, awnings and other roadside objects should be checked.

4.2.3 Crown lines

Difference

Feedback from industry is that construction of the 2 m rounding to join opposite crossfalls is very difficult to achieve and is typically not practical from a constructability perspective. A 0.5 m rounding is considered achievable and sufficient to maintain the stability of high vehicles. Motorcyclists can become unstable when crossing crown lines and this level of rounded crown line is preferred over a sharply transitioning crown line.

Figure 4.3 in Austroads *Guide to Road Design – Part 3* is replaced with Figure 4.2.3.

Figure 4.2.3 – Rounding across the crown line

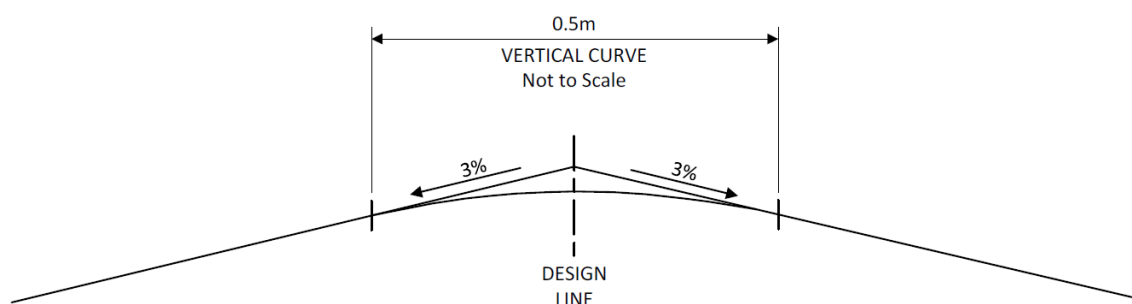

The last sentence in the 2nd paragraph is replaced with the following:

Because of these destabilising forces, crown lines parallel to the traffic lanes and located along the lines of traffic lane edges are preferred. However, under some circumstances, in order to address potential aquaplaning risk, a diagonal crown across the road while undesirable may be considered as detailed in Section 7.11. Diagonal crowns are to be considered as an EDD treatment.

Addition

With respect to the 8th paragraph and the notes to Figures 4.6 and 4.7 in *Austroads Guide to Road Design – Part 3*, every endeavour must be made to eliminate flat spots entirely from any part of the carriageway. The flow paths associated with such flat spots remain likely to cause significant flow depths in the travelled way. As water ponds at the flat spots, they are also likely to create pavement deterioration and ongoing maintenance issues.

The selection of crown locations, diagonal crowns and multiple crown lines is a key element in the design of flow paths and water film depths on the pavement and is therefore to be undertaken in coordination with the design of road surface drainage as per the Transport and Main Roads RDM.

Crossfall Configuration and Crown Lines on Side Slopes

Where there are significant differences in levels between opposite sides of an existing road, the conventional crown line location and crossfalls can result in difficulties in maintaining access and costly adjustments to properties or public utilities. In these circumstances a one-way crossfall or offset crown may be required. Appropriate EDD guidance for these treatments are described in Appendix A.

4.2.4 Traffic lane widths

Difference

In the 2nd sentence in the 1st paragraph of *Austroads Guide to Road Design – Part 3* the measurement for traffic lanes in Queensland excludes any channel component as shown in the left-hand side of Figure 4.2.4. Where a kerb only is designed as shown in the right-hand side of Figure 4.2.4, the lane width is measured to the face of the kerb.

Figure 4.2.4 – Design lane widths

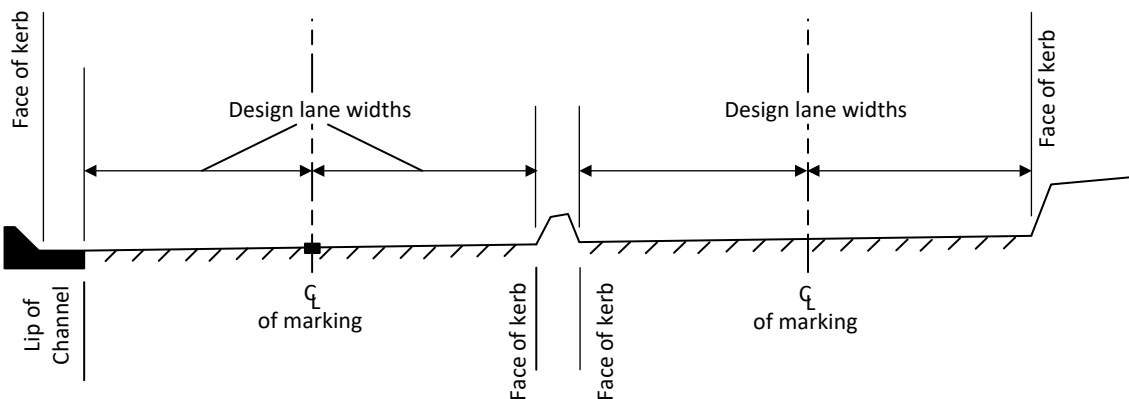

Addition

The following paragraph is added to the end of this section of *Austroads Guide to Road Design – Part 3*.

In considering the use of narrower lane widths, the legal width limit of commercial vehicles is 2.5 m, which does not include the additional 250 mm on each side of the vehicle generated by wing mirrors.

Therefore, lane widths narrower than 3.3 m should only be used in circumstances described in Table 4.3 of Austroads *Guide to Road Design – Part 3*.

4.2.5 Urban road widths

Addition

Cyclist needs (refer Section 4.9) are to be taken into consideration in application of any lane widths given in Table 4.3 of Austroads *Guide to Road Design – Part 3*.

Bus routes on existing roads

On existing roads with bus routes in extremely constrained locations, the kerbside lanes are to be marked not less than 3 m width from the face of the kerb. Where lane widths are 3 m or less, the kerbside lane should be marked wider than the adjacent lanes to offset the effects of kerbs, channels, power poles and other roadside structures. Site specific measures to mitigate the effect of the narrow lane should be investigated. These include parking restrictions, median adjustments and indented bus bays.

The following is to be added to Table 4.3 of Austroads *Guide to Road Design – Part 3*.

Element	Lane width (m)	Comments
General traffic lane	3.3 – 3.5	General traffic lane widths for use on roads in constrained corridors
General traffic lane	3.3 – 3.7	General traffic lane widths for use on bus routes

Multi-combination vehicles in urban areas

Lane widths on urban roads needing to accommodate multi-combination vehicles should be determined in accordance with the Transport and Main Roads *Route Assessment for Multi-Combination Vehicles (MCV) and Performance Based Standards (PBS) Vehicles in Queensland*.

Difference

The following changes are made to Table 4.4 of Austroads *Guide to Road Design – Part 3*:

- The title of the table is Urban motorway widths.
- The range of left shoulder widths is 2.5 – 3 m. 2 m wide left shoulders are not accepted on motorways in Queensland. A 3 m wide shoulder is justified in most cases and widths narrower than 3 m down to the minimum 2.5 m should only be applied in constrained situations.

4.2.6 Rural road widths

Difference

All text under the sub-heading 'Single carriageways' and Table 4.5 of Austroads *Guide to Road Design – Part 3* is replaced with the following:

Very-low volume roads

On very low volume rural roads, that is roads with a design traffic volume of less than 250 vpd, the selection of carriageway formation can include:

- fully unsealed road
- single lane seal with unsealed shoulders either side to allow for vehicles to pass, and
- two-lane seal.

Where a single lane seal is adopted, the minimum seal width should be at least 3.7 m (refer Table 4.2.6) and up to 4.5 m. A width of less than 3.7 m can result in excessive shoulder wear. Seal widths greater than 4.5 m but less than 6 m are not to be applied as it may lead to two vehicles trying to pass with each remaining on the seal, potentially increasing the risk of head-on crashes. The width of 3.7 m ensures that one or both vehicles must have the outer wheels on the shoulders while passing.

On a single lane seal, heavy vehicles (particularly road trains) typically remain on the narrow seal leading to vehicles in the opposing direction needing to move completely onto the unsealed section of road. The cross-section of single lane seal roads therefore needs to include sufficient space on either side to allow for passing of vehicles in the opposing direction. Particularly on tourist routes, the clearance between diverse road users such as caravans and road trains is crucial. These requirements then result in the need for a formation width wider than if a full seal were provided. In these cases, a cost benefit is required considering the option to seal the road to 8 m wide rather than increase formation width, especially when batter heights increase.

Table 4.2.6(a) describes the cross-section options for very low volume roads. The choice of the appropriate carriageway type is determined primarily based on the ongoing required maintenance activities as opposed to the operational and safety performance of the cross-section.

Table 4.2.6(a) – Very low volume (< 250 vpd) rural road minimum widths (m) – Normal Design Domain

Road Carriageway Option	Unsealed	Single-lane seal	Two-lane seal
Seal width	-	3.70	8.00
Unsealed width – each direction	4.00	2.50	0.00
Carriageway	8.00	8.70	8.00

In considering these design options for very low volume roads, the variability of traffic volumes through the year must be assessed. If there are significant time-based variations in volumes, such as between wet and dry seasons, or tourist and off peak, then an alternative measure is required to determine the design traffic volume. On both tourist routes, and unsealed seasonal routes, there is a large variation between the AADT, ADT (dry season days) 30th highest day, and highest average weekday.

The application of cross section criteria for very low volume roads should then be selected dependent on the traffic volumes in the higher volume period of the year. This is particularly true of unsealed roads, where dust plumes have a significant impact on road safety. The measure to be applied is the 30th highest day.

Single carriageways

On roads with AADT greater than 250 vpd, the cross-sections in Table 4.2.6(b) are to be applied. These widths apply to straight sections of road and on curves the requirements for curve widening are to be applied. Rural roads with AADT greater than 4,000 vpd should have a Wide Centre Line Treatment (WCLT) and Audio Tactile Line Marking (ATLM).

Table 4.2.6(b) – Minimum single carriageway rural road widths (m) – normal design domain

Design AADT	250 – 400 ⁽⁶⁾	400 – 1000	1000 – 2000		2000 – 4000		> 4000
Road Carriageway Type ⁽¹⁾	All	All	L	N	L	N	L/N
Lane Width	3.25	3.25/3.50 ⁽³⁾	3.50	3.50	3.50	3.50	- ⁽⁷⁾
Shoulders	1.00	1.25/1.00 ⁽³⁾	1.00	1.50	1.50	2.00	- ⁽⁷⁾
Carriageway ⁽²⁾	8.50 ⁽⁵⁾	9.00	9.00	10.00	10.00	11.00	- ⁽⁷⁾
Cycling ⁽⁴⁾				P	P	P	- ⁽⁷⁾

Notes:

- (1) Road Carriageway formation type:
 - L – Low embankments (i.e. < 1 m) on lower order roads where batter slopes do not exceed 1 on 4.
 - N – nominal road values.
- (2) Full width of seal required.
- (3) Optional combination of lane width and shoulder width.
- (4) A 'P' in these columns indicates cross sections generally considered suitable for 'Principle cycle routes' in rural areas. Refer to Section 4.9 for further details.
- (5) Where a road is subject to the *State-controlled Priority Road Network Investment Guidelines* (2011) and *State-controlled Low Priority Road Network Investment Guideline* (2013), the final seal width to be applied is 9 m. In these cases, the cross-section widths for the next column (400 - 1000 AADT) should be adopted.
- (6) Refer to Table 4.2.6(a) for carriageway width options for roads with less than 250 vpd AADT.
- (7) Rural roads with AADT greater than 4,000 vpd should have a WCLT and ATLM. Refer to Appendix G for general guidance and particularly Section G.4 for cross section dimensions.

In applying these carriageway cross-sections, consideration must be given to the *State-controlled Priority Road Network Investment Guidelines* (2011) and *State-controlled Low Priority Road Network Investment Guideline* (2013), which defines an interim seal cross-section width of 8 m to be applied to all road subject to funding constraints. In these cases where an existing road cross-section is less than 8 m in width, funding may allow only short sections to be upgraded to the cross-section in Table 4.2.6(b). In cases where an existing road cross-section is unable to be upgraded to the cross-section in Table 4.2.6(b), the preferred alternative is to upgrade a longer length of the road to the interim width of 8 m to achieve a greater initial safety outcome.

EDD carriageway widths are detailed in Appendix A.

4.3 Shoulders

4.3.2 Width

Addition

The following text is added to the end of Section 4.3.2:

Where the width of shoulders is changed for any reason, the transition from one width to the next is to be accomplished with a taper of 1 in 50.

Cycle Routes

For rural roads which are denoted as a principal cycle route, the values in the Table 4.3.2 are to be applied on all new roads and major road upgrades. For existing roads, reference is to be made to the

Transport and Main Roads *Cycling Infrastructure Policy* and wherever practical, the values listed should be provided. Issues such as difficult or mountainous terrain, costly service relocations, land acquisition and so on may need to be taken into account in developing a cost-effective solution for cyclists on existing corridors.

Table 4.3.2 – Shoulder width requirements to support cycling on sealed roads in rural areas with an 80+ km/h posted speed limit

AADT (vehicles per day)	Provision for cyclists
> 12,000	2 m minimum sealed shoulder (3.5 m lanes), but 2.5 m sealed shoulder is preferred
6000 – 12,000	2 m minimum sealed shoulder (3.5 m lanes)
< 6000	1.5 m minimum sealed shoulder

The following considerations apply in designing sealed shoulders for cycling use in rural areas:

- A priority cycle route can be either one identified in accordance with the Transport and Main Roads *Cycling Infrastructure Policy*.
- These widths are for where there is no roadside barrier. Where there is a roadside barrier, the shoulder widths shown become clear widths from lane edge to face of barrier.
- Design traffic volumes are to be used, typically calculated on design life of 20 years.
- Widths may need to be increased for other factors such as a:
 - high percentage of heavy vehicles
 - strong wind effects
 - steeper grades
 - high numbers of cyclists
 - where the road geometry increases the potential of vehicles encroaching into the shoulder, and
 - where parking and roadside activities may track gravel onto the shoulder.
- Ensure seal covers full width of pavement (including during rehabilitation).
- Within a 20 km radius of towns, seal size on the shoulder should provide a riding surface smooth enough for bicycles with narrow racing tyres (ideally a 10 mm seal size or other combination to achieve equivalent smoothness).

4.3.3 Shoulder sealing

Addition

Edge lines, in accordance with the Transport and Main Roads Queensland MUTCD are required in all circumstances where a shoulder is sealed or partially sealed.

Sealing may be continued beyond the shoulder point and down the batter slope on the high side to protect the pavement from ingress of water. On floodways, the seal is continued down the batter on both sides where no other protection of the batters is provided. Refer to the Transport and Main Roads *Pavement Design Supplement* for pavement seal requirements for the purpose of pavement protection.

4.4 Verge

4.4.1 Verge widths

Difference

Queensland uses the convention 1(V) on X(H) to describe a batter slope as for example 1 on 6.

Addition

The verges in Table 4.9 of Austroads *Guide to Road Design – Part 3* may be excluded under the following conditions:

- batters slopes are 1 on 4 or flatter, and
- barriers are not needed now or anticipated within 20 years, and
- sealing is extended to the hinge point to protect against natural rounding, and
- batters are quickly grassed / vegetated to protect against erosion.

In the event that any of these conditions are not met, verges from Table 4.9 of Austroads *Guide to Road Design – Part 3* must be provided.

Where verges are provided, the design and construction must ensure the pavement is drained (refer to the Transport and Main Roads *Pavement Design Supplement*).

4.5 Batters

Difference

The 3rd paragraph in Austroads *Guide to Road Design – Part 3* is replaced with the following:

Queensland uses the convention 1(V) on X(H) to describe a batter slope as for example 1 on 6.

Addition

For geotechnical design requirements of batter slopes, refer to Transport and Main Roads RPDM Volume 3, Part 1, the Transport and Main Roads *Geotechnical Design Standard – Minimum Requirements* and Technical Specification MRTS04 *General Earthworks*.

The following is added to the list of points under the 3rd paragraph:

- lining the catch drains to minimise failure of the cutting by the leaching of fines through the exposed cut face.

The 5th paragraph is added to as follows:

Generally flatter batter slopes are safer, more resistant to erosion and have a better appearance. The cost of stabilising, planting and maintaining steep slopes may exceed the cost of the additional earthworks and road reserve required to provide a flatter, possibly traversable slope. Flatter slopes also reduce the extent of safety barrier and reduce potential environmental impacts (erosion and sedimentation). However, the impact of flatter batters must be balanced against the desirability of retaining significant native flora, other environmental issues and property impacts.

The following text is added to the end of this section:

Planning design of batters

For initial planning adopt slopes of 1 on 6 or flatter for heights up to 1 m, 1 on 3 to 1 on 4 for heights of cut (excluding rock) and fill from 1 m to 2 m (3 m on highways and motorways). Above these heights,

1 on 2 may be adopted but it is preferable to use 1 on 3 maximum wherever practicable at the planning stage. Actual slopes adopted in design must consider all of the factors discussed.

Table 4.5 provides some general guidance on selecting slopes in various soil types.

Table 4.5 – Planning guidance for selecting batter slope based on soil type

Material	Soil type	Height	Slope
Stable material / rock	Cut	≤ 1 m	≤ 1 on 3
		> 1 m	≤ 1 on 2
	Fill	≤ 1 m	≤ 1 on 4 (1 on 6 preferred)
		> 1 m	≤ 1 on 2
Soils with high erosion potential (for example, sodic soils)	Cut	Any	1 on 2 with surface treatment and diversion drains above the slope
	Fill	-	Materials should not be used for fill slopes without treatment or covering with non-dispersive material
Sandy soils (lacking cohesion)	Cut	≤ 2 m	≤ 1 on 4
		> 2 m	≤ 1 on 3
	Fill	any	1 on 4 to 1 on 10

Fill batters

Where excess spoil is available, consider flattening the fill batters to 1 on 6 over the width of the clear zone, increasing the slope beyond the clear zone to a maximum of 1 on 3. Alternatively, consider using a continuous flatter slope not steeper than 1 on 4.

On existing roads, it is common practice to increase the slope of fill batters to accommodate pavement widening. However, on fills heights up to 1 m (desirably 2 m), this should only be considered if the reconstructed batter slope is limited to 1 on 4 (desirably 1 on 6).

Providing a steeper batter slope has the following problems:

- it is more difficult for drivers or riders to recover on steeper batter slopes
- it more commonly experiences water infiltration issues
- it is more difficult to mow steeper batters particularly near guardrail (unmaintained batters are unsightly and can cause issues with animals living closer to the road and issues with vegetation blocking visibility to intersections and around horizontal curves), and
- there is usually a greater need for batter protection on steeper batters.

Cut batters

Additional design consideration for cut batters should include the following for rock cuttings:

- provide access through any debris barrier to assist removal of debris
- provide appropriate clearances between the top of the batter and other obstructions and the boundary to assist maintenance including collection of debris from cutting slopes, and

- provide catch banks at the top of the batter in accordance with the Transport and Main Roads RDM.

4.5.1 Benches

Addition

Where benching is required, geotechnical input is required to determine the location of the bench and whether inward or outwards drainage is required. Refer to Transport and Main Roads RPDM Volume 3, Part 1 for further details.

Benching should not be used in soils with high erosion potential.

4.5.3 Earth bunds or mounds

Addition

For departmental requirements on the design of earth bunds or mounds refer to Transport and Main Roads documents:

- *Road Landscape Manual*
- *Transport Noise Management Code of Practice*, and
- Technical Specification MRTS04 *General Earthworks*.

4.5.4 Batter slope treatment

There is no equivalent Section 4.5.4 in Austroads *Guide to Road Design – Part 3*.

New

Variable batter slopes can be used to improve a road's appearance by blending it into the surrounding terrain. This treatment can smooth the transition between cutting and embankment, assisting the provision of lay-by areas. There are two common treatments which may be adopted for batter slopes:

- i. Constant batter slope.
- ii. Constant batter catch point type (or offset). Constant batter catch points are preferred due to the improved appearance by blending various slope batters into surrounding terrain. Catch points at a constant distance (8 m suggested) from the formation edge in light earthworks or at the ends of adjoining cuts and fills in heavier earth-works create a pleasing appearance at very small additional cost and should be adopted wherever practicable (refer Figure 4.5.4(a) and Figure 4.5.4(b)). Refer also to the Transport and Main Roads *Road Landscape Manual*.

Figure 4.5.4(a) – Batter slope treatments

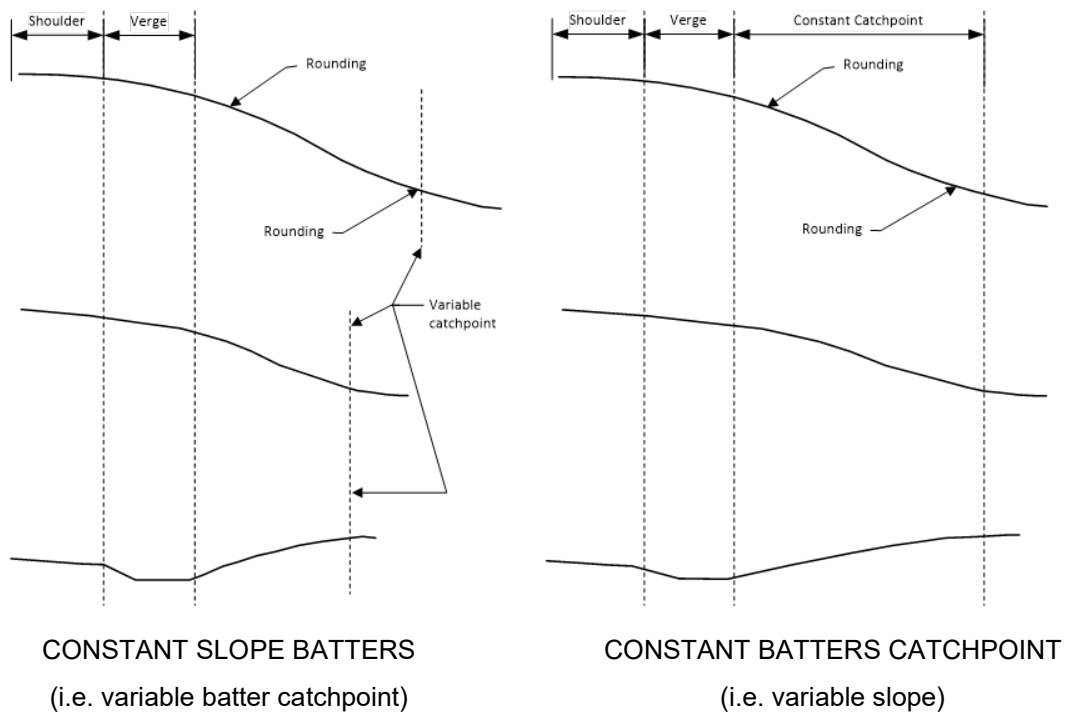
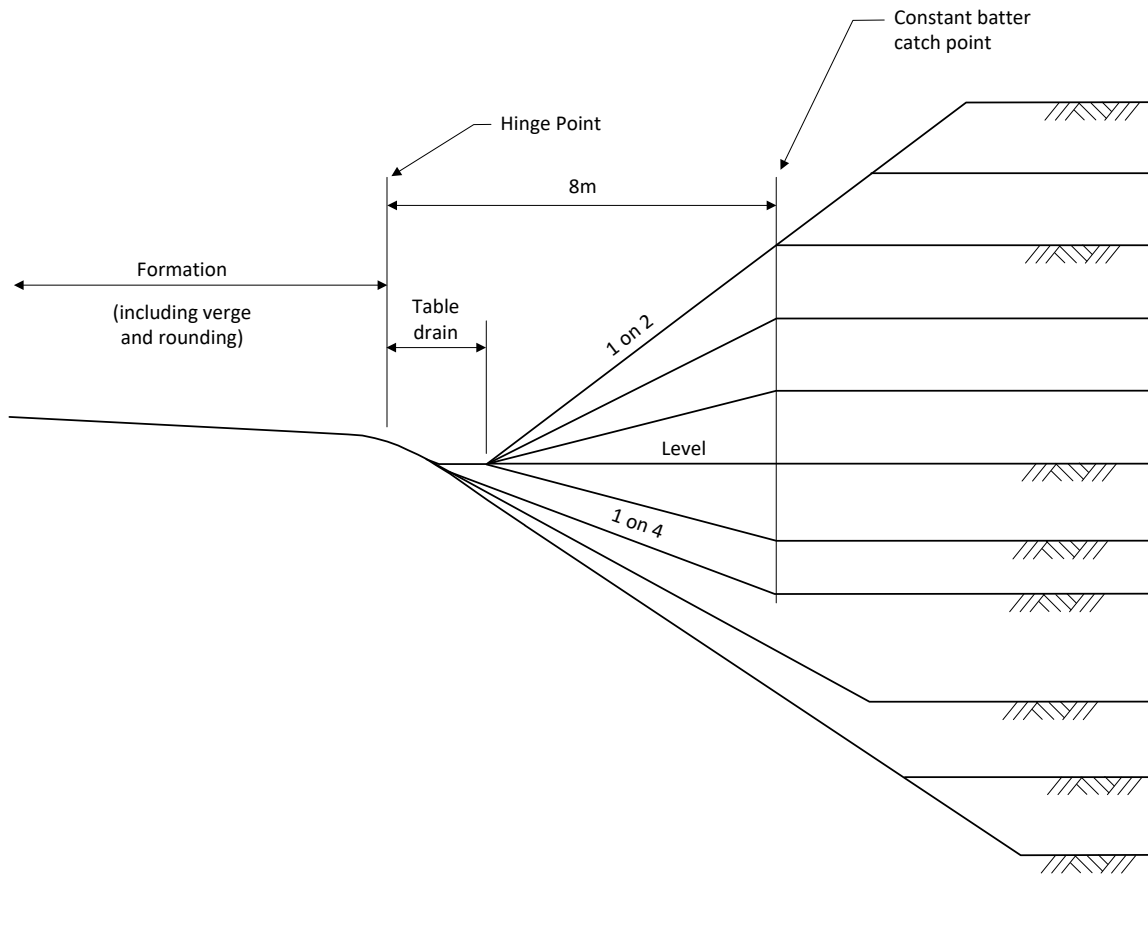

Figure 4.5.4(b) – Transition of batters from bank to cutting



Cut batters often require some form of treatment to minimise erosion and provide for stabilising the slope surface. Revegetation should be encouraged as far as possible. Where designed landscaping is implemented, the treatments will be defined and may vary from reasonably flat slopes on which formal planting is undertaken, to slopes as steep as 1 on 2 where hydraulic seeding and mulching may be carried out. In other cases, revegetation will occur more readily if the batter slopes are constructed to hold topsoil and minimise erosion. Stepped (or serrated) batters as illustrated in Figure 4.5.4(c) may often provide the necessary conditions for revegetation but these should not be used in dispersive soils, for example sodic soils. Further environmental considerations and guidelines for designing batters are provided in Transport and Main Roads RPDM, Volume 3, Part 6.

The slope and treatment to be adopted is influenced by the type of material encountered and the available right of way. The Transport and Main Roads *Road Landscape Manual* provides a range of examples of possible treatments.

Figure 4.5.4(c) – Treatment of cut batters for revegetation

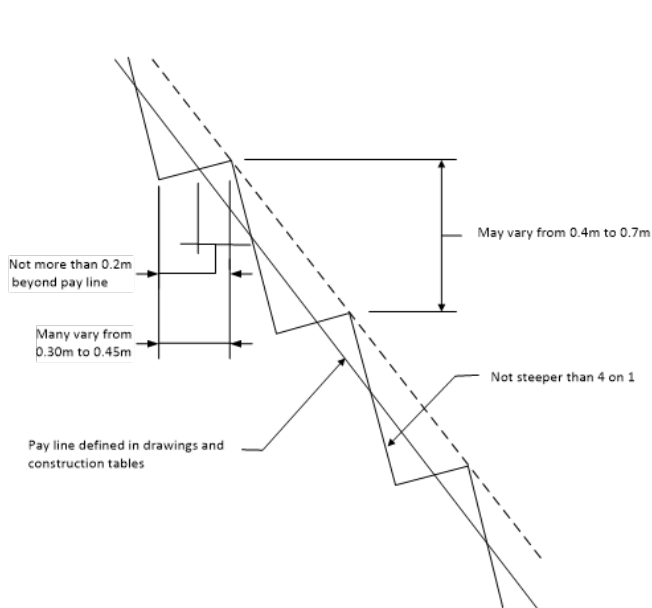
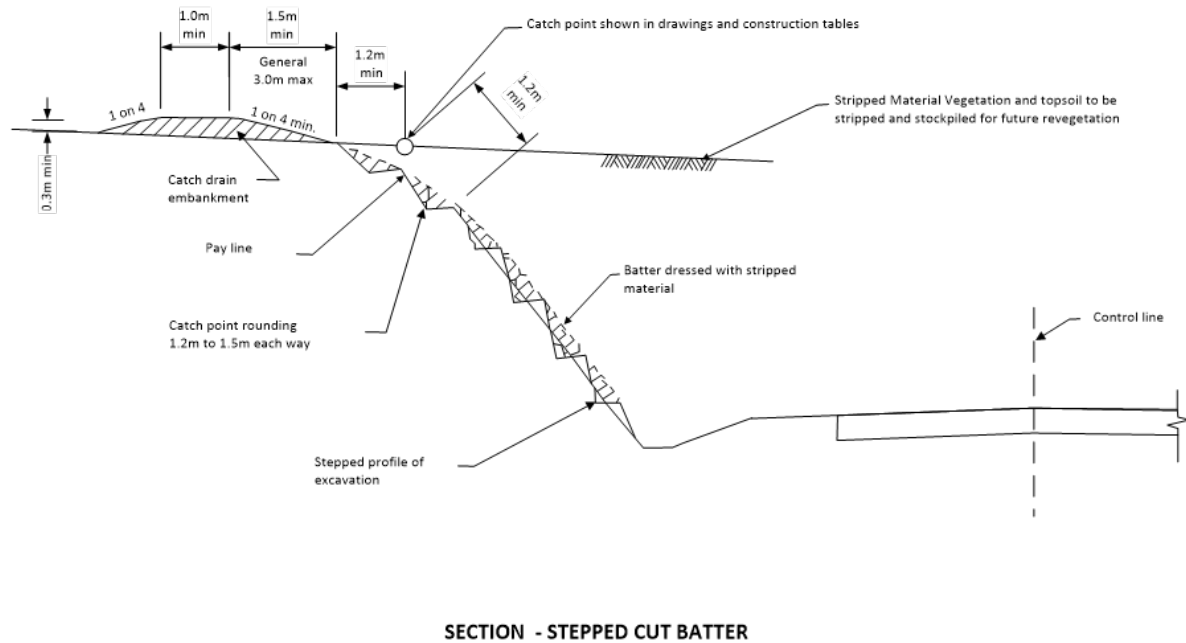

N.B.

- Only suitable for batters between 1 on 3 and 1 on 1.
- Flatter batters should be treated by contour ripping and top soiling.
- Steeper batters require special treatment.
- NOT to be used in dispersive soils.

4.5.5 Rock fall protection

There is no equivalent Section 4.5.5 in Austroads *Guide to Road Design – Part 3*.

New

Where there is potential for rock falling from the face of a cut batter on to the road surface, action is required to prevent the rock from rolling on to the surface of the road. A table drain with a base at least 1.8 m wide would normally be adequate.

However, where a table drain of inadequate width is to be used, the road should be protected with a chain wire fence erected outside the shoulder edge behind the kerb delineating the shoulder. Note the provision of a fence will introduce a roadside hazard to traffic. A site-specific risk assessment should be undertaken to determine the associated traffic risk for acceptance by Transport and Main Roads.

4.6 Roadside drainage

4.6.1 Table drains

Addition

Refer to the Transport and Main Roads RDM for more detail on the design of table drains.

Flat bottomed table drains (at least machine width or 1.8 m wide) are preferred for ease of maintenance. However, this should not be accomplished at the expense of making the cut batter steeper than 1 on 3. Erosion is less in flat bottomed channels and some advantage is gained even if 1.8 m width cannot be achieved. A minimum total verge width of 2 m (see Figure 4.6.1) provides space for a mower to operate.

If it is necessary to deepen the table drain, the cutting should be widened so that the maximum 1 on 4 side slope on the verge is maintained. Desirably the depth should not exceed 1 m.

The arris or edge formed by the side of a table drain and the shoulder should be rounded to minimise damage to errant vehicles.

The key design features for table drains are:

- Unlined drains minimum grade is 0.5% (with an absolute minimum of 0.2%). These minimum grades are to be avoided if possible and kept to short lengths (preferably below 30 m to 50 m).
- Lined drains:
 - Have a lower limit of 0.3% due to constructability issues.
 - May be formed in the shape of the Type 28 channel as shown in the department's Standard Drawings, or specially designed to suit the conditions. On both the nearside and the offside of each carriageway in a cutting, a 0.6 m wide Type 22 or 1 m wide Type 28 channel will be provided if the drain falls within the shoulder. Note if the channel is positioned in front of, or within the deflection width of a road safety barrier system a site-specific risk assessment should be undertaken to determine the likely impact on barrier performance and associated risk for acceptance by Transport and Main Roads.
- Where superelevation is provided it will be permissible for the water on the offside to run straight into the median. However, consideration is to be given to the provision of a Type 22 or 28 channel on the offside edge.

- For 'V' shaped channels a concrete invert should be considered because of the difficulty in maintaining the section. On grades less than 1.5% and for most cross sections, a concrete invert is essential in assisting the discharge of low flow. Maintenance operations are extremely difficult with saturated conditions in the vicinity of an unlined invert.

The red arrows on Figure 4.16 in Austroads *Guide to Road Design – Part 3* indicate the direction of a cross slope on the bottom of the table drain.

Figure 4.6.1 – Typical table drain details

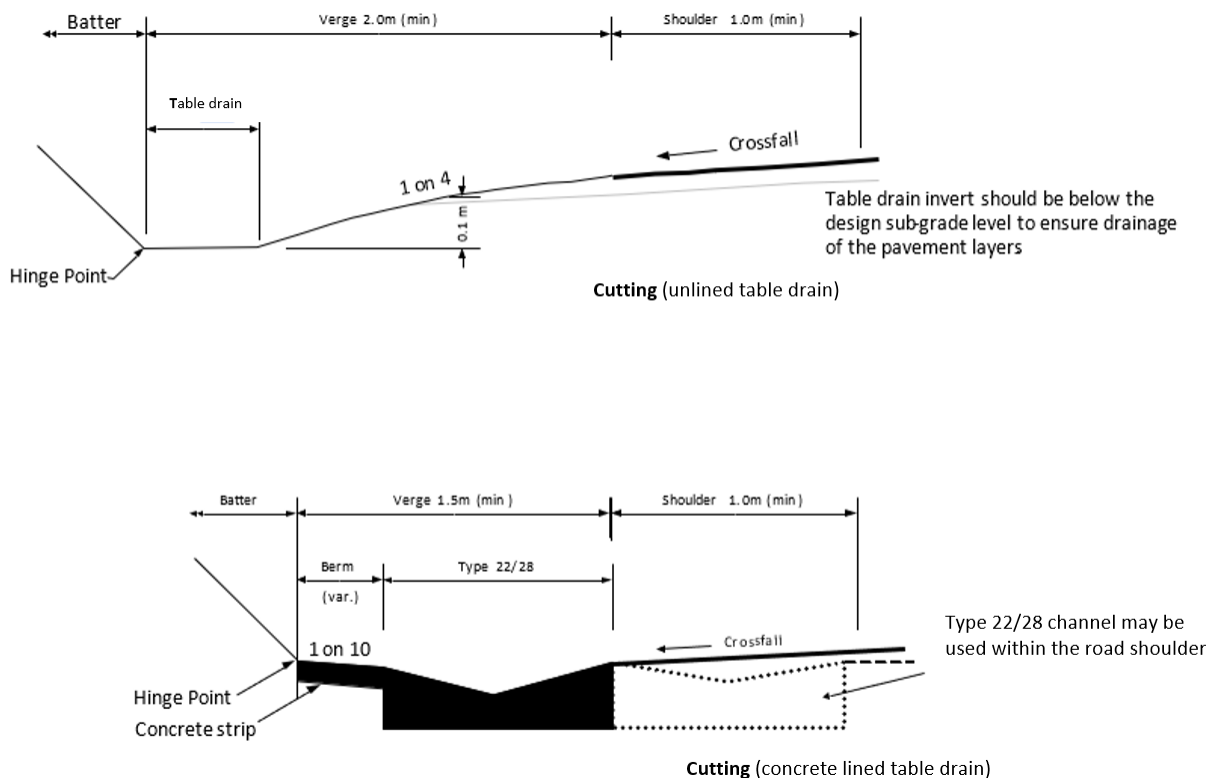

4.6.2 Catch drains

Addition

Refer to the Transport and Main Roads RDM for more detail on the design of catch drains.

If the upstream catchment is small, drainage can be sheeted over the face of the slope provided erosion control treatment has been applied to the slope and catch drains may not be required.

Catch drains should be constructed to have a rounded or trapezoidal cross section (see Figure 4.6.2), rather than a 'V' shaped cross section (which are more prone to erosion).

Depending on the runoff velocity, catch drains should be stabilised immediately by seeding, turfing, planting in conjunction with jute mesh, bitumen, masonry, rock mattresses or concrete lining. Where an unlined drain is to be used, the designer must consider both the long-term performance of the treatment and the likely performance of the treatment during the establishment period.

In areas where the catch drain is susceptible to scour, the surface water should be intercepted using a catch bank placed on the natural surface on the high side of the batter point. There is no excavation of the surface to provide the earth for the bank or to create the drain. The natural surface is therefore not disturbed and not exposed to erosion to the same degree.

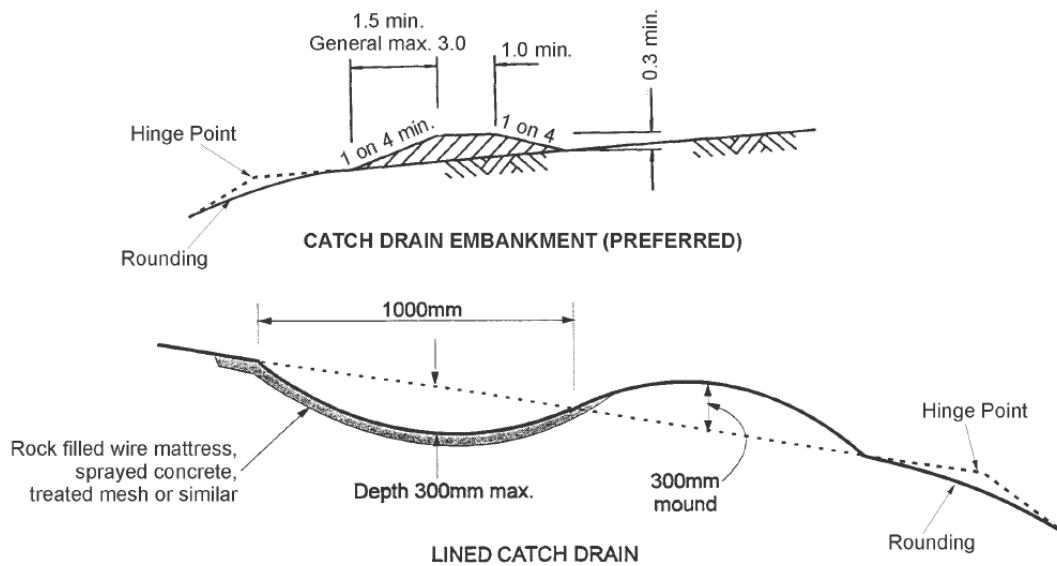
Figure 4.6.2 – Typical catch drains

4.6.3 Median drains

Difference

Flat bottomed median drains (at least machine width or 1.8 m wide) are preferred for ease of maintenance. However, this should not be accomplished at the expense of making the cut batter steeper than 1 on 3. Erosion is less in flat bottomed channels and some advantage is gained even if 1.8 m width cannot be achieved.

Addition

Refer to the Transport and Main Roads RDM for details of median drain design.

The key design features for median drains are similar to that of table drains (refer to Section 4.6.1).

Longitudinal drainage of medians should drain from both sides to appropriate gully pits without blocks. Where blocks, levees, median cross-overs and so on are required, the slopes facing traffic should be 1 on 20 with an absolute maximum of 1 on 6.

Longitudinal culverts in the median should be avoided. A preferred arrangement is to collect the water in a drop inlet and dispose of it to the roadside or into adjacent cross-drainage installations. Where longitudinal culverts are necessary, a Transport and Main Roads approved sloping end wall unit must be installed.

Where kerbed medians are adopted and drainage channels are required to facilitate cross median flows of pavement runoff, consideration should be given to safe pedestrian use of raised medians in urban areas. Drainage slots can pose a hazard to pedestrians and wherever possible should be avoided where pedestrian activity may occur. Alternatively, the following solutions may be considered:

- delineation of the edges of the drainage slot
- widening the drainage slot to become a clear step down and up
- edging the slot with mountable kerb or similar sloped edge, and/or
- fencing the median to discourage pedestrian use.

Replacing the slot with a box culvert or covering / plating the slot is not recommended due to maintenance issues.

4.6.4 Kerb and channel

Addition

Kerb or kerb and channel on high speed alignments is not to be used except in constrained situations, and prior to intersections. In addition to the safety problems caused by the kerb, separate drainage facilities are required. In these cases, a shallow concrete lined v-drain with subsoil drainage usually provides a better solution.

Add to the dot point on high profile barrier kerb:

- High profile kerb (> 150 mm) located on the inside of intersection turns may not be expected by motorcyclists and may increase the chance of a crash caused by a kerb sideswipe. Barrier kerbs in these locations can snag the motorcycle foot pegs, create instability and possibly cause a crash.

Add to the second last dot point in this section:

- If kerb and channel is essential on the outside of low radius curves, sufficient clearance to avoid the outwards tail swing of large trucks (check with VPath) must be provided.

Add additional dot point on at the end of this section:

- Barrier kerb can also inflict severe injuries to a dismounted motorcyclist and semi-mountable kerb is preferred over barrier kerb to minimise impact forces in these events. Consideration should be given to removing the kerb if possible, installing a more forgiving kerb profile, or using a rubberised kerb island in highly exposed locations.

The Transport and Main Roads *Standard Drawings* show the standard shapes, dimensions and applications of kerbs and/or kerb and channel that may be used.

The dimension 'AA' noted on the Standard Drawing should be less than 30 mm in areas of potential motorcycle kerb conflict (for example, roundabouts and approaches to median islands). In areas of potential bicycle kerb conflict 'AA' is preferably less than 5 mm and should not exceed 10 mm.

Other key points to include in the design of kerbs:

- 1.5 m (min) transition is to be provided to change from one kerb type to another (semi-mountable to barrier; new kerb to existing of a different shape).
- A 450 mm channel should be adopted where kerb and channel is required unless special circumstances apply.
- In areas subject to over-dimensional or heavy vehicles mounting the kerb, a backing strip is to be included.
- The kerb colouring must not blend in with the road surface.
- Temporary kerbing:
 - is to be avoided in in high speed areas
 - is to be a Transport and Main Roads approved product and must be properly secured when used in low speed areas, and

- all grates located adjacent to sealed shoulders or bicycle lanes are to be bicycle safe in accordance with Australian Standards.

4.6.5 Dykes and batter drains

There is no equivalent Section 4.6.5 in Austroads *Guide to Road Design – Part 3*.

New

A dyke is a low (nominally 50 – 100 mm high) longitudinal mound made out of earth, asphalt or concrete. It is provided near the edge of embankments when it is required to protect the batters from erosion, by controlling the water movement off the road pavement surface. It is not considered a safety treatment. Note if the dyke is positioned in front of, or within the deflection width of a road safety barrier system a site-specific risk assessment should be undertaken to determine the likely impact on barrier performance and associated risk for acceptance by Transport and Main Roads.

Water contained by dykes is to be carried down the face of the batter by batter drains. The location and design of batter drains is detailed in the Transport and Main Roads RDM.

4.6.6 Access chambers

There is no equivalent Section 4.6.6 in Austroads *Guide to Road Design – Part 3*.

New

Access chambers should preferably be located clear of the carriageway to provide for easier construction of the pavement. It also removes a source of potential maintenance problems and is safer for workers using the access chambers. Where access chambers must be located within the carriageway, they should preferably be placed in the parking lane or shoulder. They should only be located within the trafficked lanes of the carriageway where all other options have been exhausted and agreement from Transport and Main Roads Operations and Maintenance teams has been obtained.

Where existing access chambers are located in the carriageway, designers should consider the potential to protect them rather than relocating them.

4.6.7 Floodways

There is no equivalent Section 4.6.7 in Austroads *Guide to Road Design – Part 3*.

New

The hydraulic design of floodways is detailed in the Transport and Main Roads RDM.

It is desired that reasonable uniformity in floodway widths is provided throughout Queensland without limiting consideration of particular features of one site or locality in arriving at the appropriate design.

The floodway formation width should be the same as the approach formation with a minimum of 8 m on existing low trafficked roads.

Safety barriers and bridge rails reduce the efficiency of the floodway in times of flood, but may be desirable for road safety at other times. The installation of safety barrier should be determined locally. Where the barriers are associated with a bridge structure:

- When the bridge is full floodway width, and the main channel is shallow, consideration should be given to omitting bridge rails and safety barrier. Road edge guide posts may be provided on the floodway at the bridge abutment.
- When the bridge is narrower than the floodway, or the channel is deep, bridge rails may be required with safety barrier protection on the approach to the bridge.

The conflict in providing adequate delineation against the obstruction any bridge rails or safety barriers provide to water flow, must be decided locally based on site-specific risk assessment.

4.7 Medians

Addition

Median warrants

Medians are required in the following circumstances:

- New rural roads of four lanes (two-lanes each way) or more.
- Existing rural roads when widened to four lanes or more.
- Where passing lanes in each direction overlap so that the road becomes a four-lane section. In this case a painted median at least 1 m wide is required, and
- New urban roads of four lanes desirably require a median. Where roads are built as six lanes a median is required. On multi-lane roads, all right turns at intersections must be provided with a CHR or CHR(s) right turn treatment (refer to Transport and Main Roads RPDM, Volume 3, Part 4A).

Median design features

The design of medians should consider the following:

- Medians should be kept clear of hazards - refer to Transport and Main Roads RPDM, Volume 3, Part 6B.
- Features limiting the horizontal sight distance on curves must be located such that adequate sight distance is maintained.
- In urban areas, the design of the median should ensure that it is as maintenance free as possible to minimise the exposure of maintenance personnel to traffic hazards.
- All landscaping should be designed in accordance with the Transport and Main Roads *Road Landscape Manual*.

4.7.1 Median treatments

Wide centreline treatment

Difference

The 1st paragraph refers to WCLT as a form of median which is incorrect as for legal purposes a WCLT is not considered to be a median.

4.7.2 Median width

Difference

The title for Table 4.15 in Austroads *Guide to Road Design – Part 3* is amended to 'Median widths' as it is intended to apply to all medians in both urban and rural areas.

Addition

The notes to Table 4.15 in Austroads *Guide to Road Design – Part 3* are amended as follows:

- 3 *Only suitable for low speed constrained sites in straight alignment. This width is the absolute minimum and wider medians may be required dependant on the barrier profile and any elevation difference between carriageways.*

- 4 *Desirable width that provides approximately 0.5 m clearance on each side of the barrier. This width is the minimum to be applied for future barrier installation with no right turn bays or significant pedestrian activity. This width may need to be adjusted based on the likely actual profile of the barrier to be used in order to maintain 0.5 m minimum clearances to traffic lanes.*
- 6 *Recovery area – Historic practice in Queensland has been to use a 15 m median which can be retained for existing roads. 20 m may be provided where reasonably practical or where required for a two-stage crossing of a semi-trailer.*

Rural median widths

Addition

For all divided roads with posted speed greater than or equal to 80 km/h, medians will be clear of all hazards unless shielded by a road safety barrier.

For all divided roads with posted speed greater than or equal to 80 km/h with AADT greater than 10,000 vpd, physical separation by median road safety barrier is required.

In rural areas, if the right-of-way is available, the costs of a wider median may be minimal or unchanged from that required for a narrower median. Wider medians introduce the potential to independently grade each carriageway which may lead to more cost-effective solutions.

Add to the last paragraph:

Future widening into the median also:

- Minimises traffic disruptions during construction of the widening. This needs to be qualified with the requirement that the median needs to be wide enough so that suitable construction access is achieved.
- Minimises interference with roadside furniture, drainage installations and environmental protection devices.
- Prevents further environmental damage during construction of the widening.
- Avoids disturbing cut batters (particularly important in potentially unstable or erodible country), and
- Avoids relocation of motorway ramps where they have been designed for the ultimate alignment.

Staged construction of roads should therefore include a median width in the first stage such that the width after widening meets the minimum width requirements in Table 4.15 of Austroads *Guide to Road Design – Part 3*. Desirably the median should be at least 15 m after widening for motorways and rural roads to provide the safest situation.

Median widths for motorways should be as for rural roads. In constrained urban situations, narrower medians provided with barriers may be appropriate. The available median width will dictate the barrier type to be used. The absolute minimum median width will be required to accommodate a concrete barrier with a clearance of 2 m (3 m for 3 or more lanes) to the face of the barrier. This provides for the 'shy line' distance on the median side.

4.7.6 Median surfacing

Addition

The information in this section should be considered for information only. Reference is to be made to the Transport and Main Roads *Road Landscape Manual* and Transport and Main Roads RPDM, Volume 3, Part 6.

4.9 Bicycle lanes

4.9.1 General

Difference

Replace the 5th paragraph in Austroads *Guide to Road Design – Part 3* with the following:

In Queensland, the selection of the type of facility to be provided is determined through consideration of the Transport and Main Roads *Cycling Infrastructure Policy*, TRUM and associated Technical Notes.

Addition

The design of the pavement and in-road items such as drainage grates or access covers shall consider the needs of cyclists.

4.9.4 Cross-section and clearances

Difference

The 1st sentence in the 3rd paragraph is replaced with the following:

Bicycle lane width should be measured to the lip of the channel if the channel surface cannot be safely used by cyclists (e.g. channel surface is not smooth, has excessive cross slope or is prone to becoming slippery due to mould).

4.9.5 Separated bicycle lanes

Difference

The information in this section is to be considered for information only. Separated bicycle lanes should be designed in accordance with the Transport and Main Roads Guideline *Selection and Design of Cycle Tracks*.

4.9.6 Contra-flow bicycle lanes

Addition

The width of contra-flow bicycle lanes is to be in accordance with the requirements documented in the Transport and Main Roads Guideline *Selection and Design of Cycle Tracks*.

The entrance at the start of the contra-flow bicycle lane should include consideration for the following:

- Where a tight radius turn is located to enter the facility, additional width should be designed where practical to allow for some margin of turning error. This is particularly required where physical dividers are placed near the entry point. If a cyclist miscalculates the appropriate line around a curve and a divider is placed in an area where the cyclist is still on a lean, evasive action by the cyclist will usually result in the cyclist overshooting the required entry line.

- Visibility to a physical divider should be provided on the approach as the divider may pose a safety risk to cyclists.
- Where kerb separation is adopted intersection areas should be adequately lit.

4.9.10 Bicycle / car parking lanes

Addition

A 4.5 m bicycle / car parking lane width is preferred to allow cyclists to avoid opening doors of parked cars.

The design of bicycle lanes in conjunction with roadside parking should take into account the issues detailed in the Transport and Main Roads Guideline *Selection and Design of Cycle Tracks*.

On left hand curves, parked cars can 'truncate' the corner using space allocated to cycles in a bicycle / car parking lane. Restriction of parking in these circumstances should be considered.

4.9.11 Wide kerbside lanes

Difference

Austroads *Guide to Road Design – Part 3*, Table 4.21: Wide kerbside lane dimensions, Note 3 is replaced with 'The width of the lane excludes any channel component.'

Addition

On the Principal Cycle Network a shared lane may only be considered in a highly constrained retrofit project after all other attempts to provide dedicated facilities, as described in Austroads *Cycling Aspects of Austroads Guides* (2014), have been thoroughly explored. Shared lanes implemented on the Principal Cycle Network are to be considered a temporary facility only until the next capital upgrade project occurs.

Shared lanes on the Principal Cycle Network must include supporting signage. Shared lanes on routes other than the Principal Cycle Network should consider the use of advisory treatments. Advisory treatments warn road users of the potential presence of cyclists and consist of pavement markings, warning signs or guide signs. These advisory treatments are detailed in the Transport and Main Roads Queensland MUTCD, QGTM and TRUM manuals.

4.11 On-street parking

4.11.2 Parallel parking

Addition

A parallel parking lane used as a traffic lane during peak times should meet the cross-section requirements outlined in Section 4.2.5.

4.12 Service roads, outer separators and footpaths

4.12.1 Service roads

Difference

Austroads *Guide to Road Design – Part 3*, Note 1 of Table 4.27: Typical minimum service road carriageway widths for roads with low traffic volumes and low parking demand is replaced with 'The width of the lane excludes any channel component.'

4.12.2 Outer separator

Replace the last sentence relating to safety barriers in *Austroads Guide to Road Design – Part 3* with the following:

The potential requirement for safety barrier protection should be assessed in line with the guidance in Transport and Main Roads RPDM, Volume 3, Part 6.

4.12.3 Urban border

Addition

General

The design of the urban border, including footpaths and driveways must consider the relevant Local Government requirements and the needs of Public Utility Plant (PUP) Authorities.

Footpaths

If kerbing is not provided at the edge of the carriageway, sufficient verge width should be provided to enable pedestrians to walk clear of the road carriageway (i.e. traffic lanes and shoulders).

Footpaths and driveways

Depressed footpaths introduce drainage issues and should only be considered where access conditions or the high costs involved in property and utility adjustments restrict alternative levels.

Vehicle templates for standard vehicles should be used to ensure they can use the driveway without bottoming on the footpath.

4.13 Bus stops

4.13.2 Urban

Addition

The information in this section should be considered for information only. Reference is to be made to the TransLink *Public Transport Infrastructure Manual* (PTIM).

4.14 Roads in expansive soils in Western Queensland

There is no equivalent Section 4.14 in *Austroads Guide to Road Design – Part 3*.

New

Reference should be made to the Transport and Main Roads *Pavement Design Supplement* for guidance on the design of pavements in expansive soils. The information in this section discusses the specific impact on the desirable cross section features of these soil types and is focussed on measures to minimise the ingress of moisture into the road pavement. Figure 4.14 details the key elements relating to cross section design on expansive soils.

Figure 4.14 – Desirable cross section elements for expansive soil lane

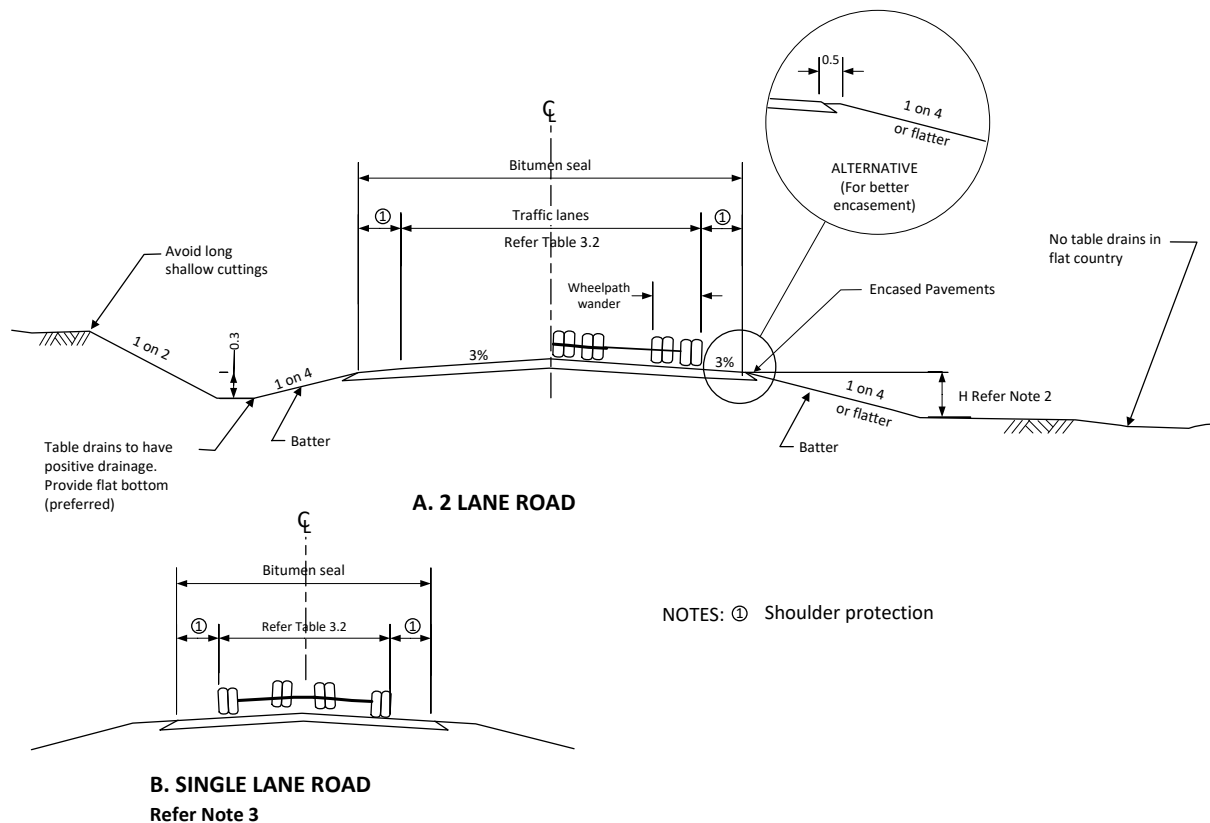

Shoulder protection

In all paving materials, moisture will still enter the pavement producing edge effects of pavement and subgrade weakening to about 1 m in width.

The following elements are to be considered in the cross section for the protection of shoulders:

- At least 1 m of sealed pavement outside the edge of the wheel path of heavy vehicles is to be provided.
- The location of edge and centreline marking should be reviewed to assist in ensuring wheel paths are located as per the design.
- Additional seal may be required on crests and curves to allow for vehicles tracking further from the centre lane line due to visibility restrictions and vehicle tracking characteristics.

Encased pavements

Moisture can still be absorbed by pavement material exposed on the batters. Moisture ingress can be reduced by minimising excess pavement width beyond the seal as follows:

- The design should therefore cut the pavement batter to 1 on 2 at the seal edge, remove excess pavement material and encasing the pavement with embankment at a 1 on 4 slope.
- Further positive encasement can be provided by adding 300 to 500 mm of embankment on both sides of the formation.
- Spraying bitumen (without cover aggregate) on the top 300 mm of the pavement batter before encasing further improves performance.

Batter slope and formation height

The following requirements minimise moisture changes below the pavement:

- Batter slopes of 1 on 4 or flatter should be used on all fills up to 2 m.
- The formation needs to be above the surrounding terrain but kept as low as possible (approximately 300 – 500 mm at the top of pavement at formation edge).

Longitudinal drainage

- Table drains should not be used in flat country where they will not drain. Batters should be used to divert water further from the road.
- On gentle grades which results in positive drainage, table drains may be used to minimise earthworks.

4.15 Roads in rainforest (including the wet tropics)

There is no equivalent Section 4.15 in Austroads *Guide to Road Design – Part 3*.

New

For the design of roads in rainforests, particularly those in steep / mountainous terrain, there are additional design considerations to minimise environmental impact as follows:

- Reduce the clearing width as much as possible through use of barriers.
- On scenic (tourist) roads, particularly in World Heritage Areas, a single lane two-way cross-section is desirable allowing for safety and operational considerations. The width can be reduced by providing drainage on one side of the road only.
- On two-lane roads, two single lanes separated by a wider median may also have less environmental impact than the two-lane road. In steep sidelong country this design will better match the terrain with less height to cuts and fills.
- Higher volume roads requiring four lanes or more should include a wide median to improve canopy closure.

Road formation / earthworks

Requirements in addition to those described for normal road design are as follows:

- Cut and fill can have a major visual impact and can dominate the landscape. The scenic view of the road alignment should be assessed and if major cuttings or fills will be visible then consideration should be given to altering the alignment to avoid the cut being viewed from distant vantage points. Where the cut and fill cannot be avoided then revegetation of the batter should be given a high priority.
- In the Wet Tropics World Heritage Area, apart from the cut and fill associated with the earthworks, obtaining additional material from borrow pits is generally prohibited unless specific approval has been obtained from the Wet Tropics Management Authority.
- Additional benches may be required on cut slopes and batters to facilitate additional landscaping.
- The cut / fill transition zone provides areas for fauna crossings and barriers across these sections should be avoided.

5 Sight distance

5.2 Sight distance parameters

5.2.3 Longitudinal deceleration

Difference

The 4th row of Table 5.3 in Austroads *Guide to Road Design – Part 3* is replaced with the following:

Vehicle type	Coefficient of deceleration (d)	Driver / road capability	Typical use
Cars	0.26	Comfortable deceleration on sealed roads for turn lanes at intersections. Maximum value for calculation of horizontal curve perception sight distance.	Not to be used without the approval of the relevant road agency (refer to Section 5.3.1). This value is not to be adopted for stopping sight distance for major highways and freeways in flat terrain in Queensland. Its use can lead to an unnecessarily high standard and expensive design in undulating or hilly terrain. Maximum value for calculation of horizontal curve perception sight distance.

The final note under Table 5.3 of Austroads *Guide to Road Design – Part 3*, relating to a coefficient of deceleration of 0.26 for cars, is not relevant to Queensland practice.

5.3 Stopping Sight Distance (SSD)

5.3.1 Car stopping sight distance

Difference

In the 4th paragraph, with reference to Table 5.3:

- The reference to Table 5.4 in the first dot point is incorrect and should refer to Table 5.5.
- The use of a 0.26 coefficient for cars is not relevant to Queensland design practice except where identified in Section 5.2.3 above. Hence the green shaded area in Table 5.5 is not to be applied in Queensland.

Note 7 under Table 5.5 of Austroads *Guide to Road Design – Part 3*, is amended to note that values in the green shaded area are not to be applied in Queensland.

5.3.2 Truck stopping sight distance

Difference

In the 3rd paragraph the reference to Table 5.5 is incorrect and should refer to Table 5.6.

5.4 Sight distance on horizontal curves

5.4.1 Benching for visibility on horizontal curves

Addition

Where a line of sight must be preserved, this should be included in the maintenance requirements of the road. For design, the height of the bench must allow the line of sight to pass over it unobstructed and must be set at least 300 mm (or the maintenance intervention level, whichever is the greater) below the line of sight to allow for growth of grass on the bench to this height.

If a line of sight cannot be guaranteed, then the design cannot assume that it will exist and an alternative treatment must be applied, for example a larger radius curve.

Where stopping sight distance cannot be provided around a horizontal curve in a side cutting, manoeuvre sight distance in accordance with Table 5.6 of *Austroads Guide to Road Design – Part 3* should be provided with appropriate manoeuvre space.

5.5 Sight distance requirements on horizontal curves with roadside barriers / wall / bridge structures

Addition

The flow charts and table referred to in Appendix H should only be treated as providing informative assistance. They are not representative of all possible scenarios or allowable combinations of design criteria, for instance, they do not include for the use of EDD criteria and have only considered a limited number of object heights. Relying solely on these aids for design may not result in optimal outcomes.

5.6 Overtaking sight distance

5.6.1 General

Difference

Replace the 2nd sentence of the 2nd paragraph in *Austroads Guide to Road Design – Part 3* with the following:

For this reason, it is desirable that the road pavement is continuously visible for at least the minimum overtaking sight distance prescribed in Table 5.8 and Table 5.9.

Addition

In some cases, where it is impracticable or uneconomical to provide overtaking sight distance, short lengths of overtaking may still be appropriate. Particularly in terrain which results in a large variation in the speed of individual vehicles or heavy vehicles, a length of road allowing overtaking but with something less than the overtaking sight distance provides opportunities for a proportion of drivers.

5.6.4 Determination of percentage of road providing overtaking

Addition

Figure 5.6.4 demonstrates an example for determining the proportion of road overtaking provision.

Figure 5.6.4 – Calculation of overtaking zones

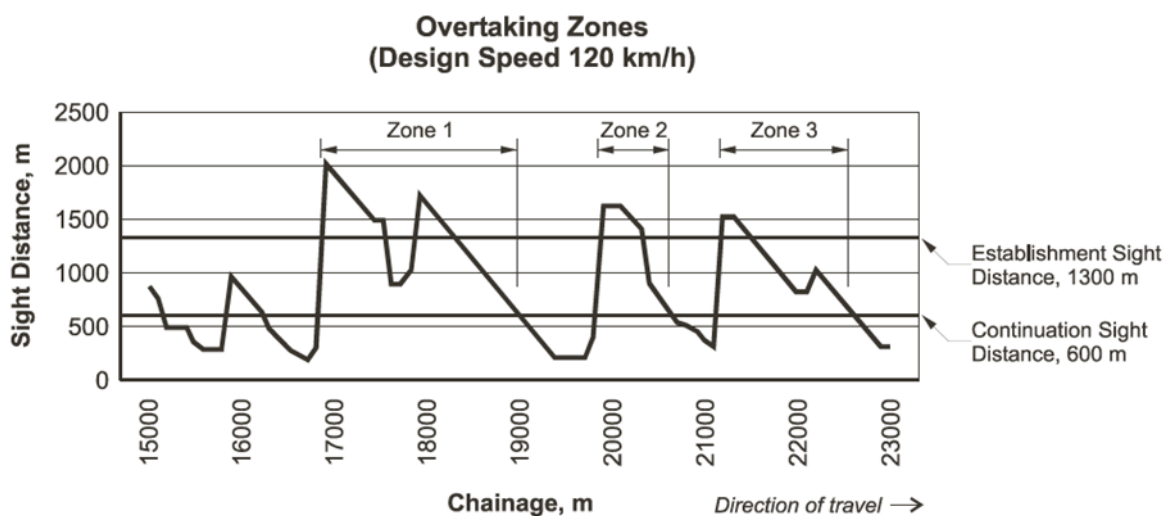

The proportion of road that provides overtaking in accordance with the overtaking model is measured for both directions so that the total length of the overtaking zones for both directions is divided by twice the length of the road being considered.

The overtaking model is not used as a warrant for barrier lining. Even though a section of road will not have sufficient sight distance to satisfy the overtaking model, there may be sufficient sight distance to allow for the safe overtaking of very slow vehicles. Barrier line warrants are provided in the Transport and Main Roads Queensland MUTCD.

5.8 Intermediate sight distance

Addition

Restricted visibility widening is the local widening of one lane, two-way roadways and is applied where Intermediate Sight Distance is not obtained, or it is preferred to widen rather than attempt to obtain it. This only applies to a single lane roadway of less than 6.2 m in width. In isolated cases, if intermediate sight distance cannot be obtained then the roadway must be widened to at least 6.2 m. Note that the requirement needs to be checked for truck sight distance as well (eye height 2.4 m).

The extent of the widening in the case of a vertical curve is shown in Figure 5.8. The method is equally applicable to horizontal curves where an obstruction such as a building or a cutting restricts the sight distance. The widening is applied from the point where the double vehicle stopping sight distance is first restricted for traffic in either direction.

Where sections of widening occur close together the intervening short length of un-widened pavement could be hazardous and displeasing in appearance. Where the length between the ends of the tapers of sequential widened sections is less than $2V$ in metres (V is the operating speed in km/h), the full widening shall be carried through the two sections.

When restricted visibility widening is applied on horizontal curves, any curve widening that would normally apply is additional to the required visibility widening. It is good practice to extend the restricted visibility widening over the whole curve to provide a constant cross section for the full length of the curve. Changes to the width around the curve could force changes to the curve radius throughout the curve (undesirable especially for motorcycles). In addition, its application and removal at the start and end of the curve is more pleasing than when applied or removed within the curve.

Where widening is required for only a short length and is contained wholly within a horizontal curve, it may be dealt with as curve widening.

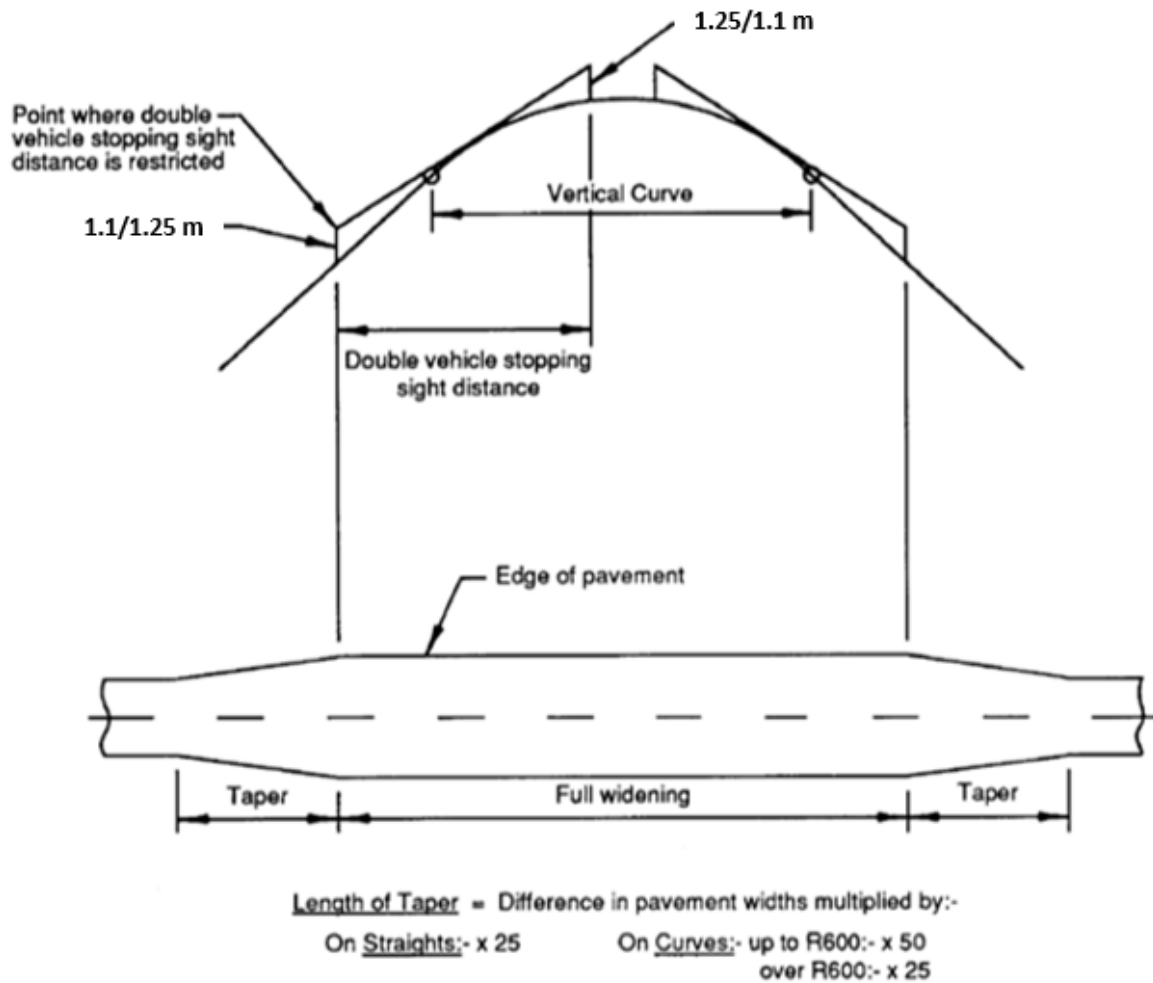
Figure 5.8 – Restricted visibility widening application to vertical curves

6 Coordination of horizontal and vertical alignment

6.2 Safety considerations

Addition

Designing for sun position

It is not always possible to design a road to avoid the impact of the sun shining directly into a driver's eyes, however careful consideration should be given where conflict situations, such as an intersection on the crest of a hill, occur. Measures to address sun glare include judicious application of curvature, subtle changes in direction and provision of appropriate landscaping. The position of the sun throughout the year makes detailed analysis complex. While there are minor differences in the sun location across Queensland, it should be considered for roads aligned between:

- 62.5 degrees south of north (east for sunrise and west for sunset) - sun location at 21 June, and
- 117.5 degrees south of north – sun location at 22 December.

6.3 Aesthetic considerations

6.3.1 Coincident horizontal and vertical curves

Addition

Optical summit

The phenomenon of ‘Optical Summit’ which gives the effect of a rise where there is not one, can occur in some combinations of vertical and horizontal alignments.

In the example shown in Figure 6.3.1 the appearance is improved considerably by adjustments to both alignments. The horizontal curve has been lengthened to encompass both of the sag vertical curves and the sag curves have been lengthened to be more in keeping with the scale of the other movements.

Figure 6.3.1 – The optical summit

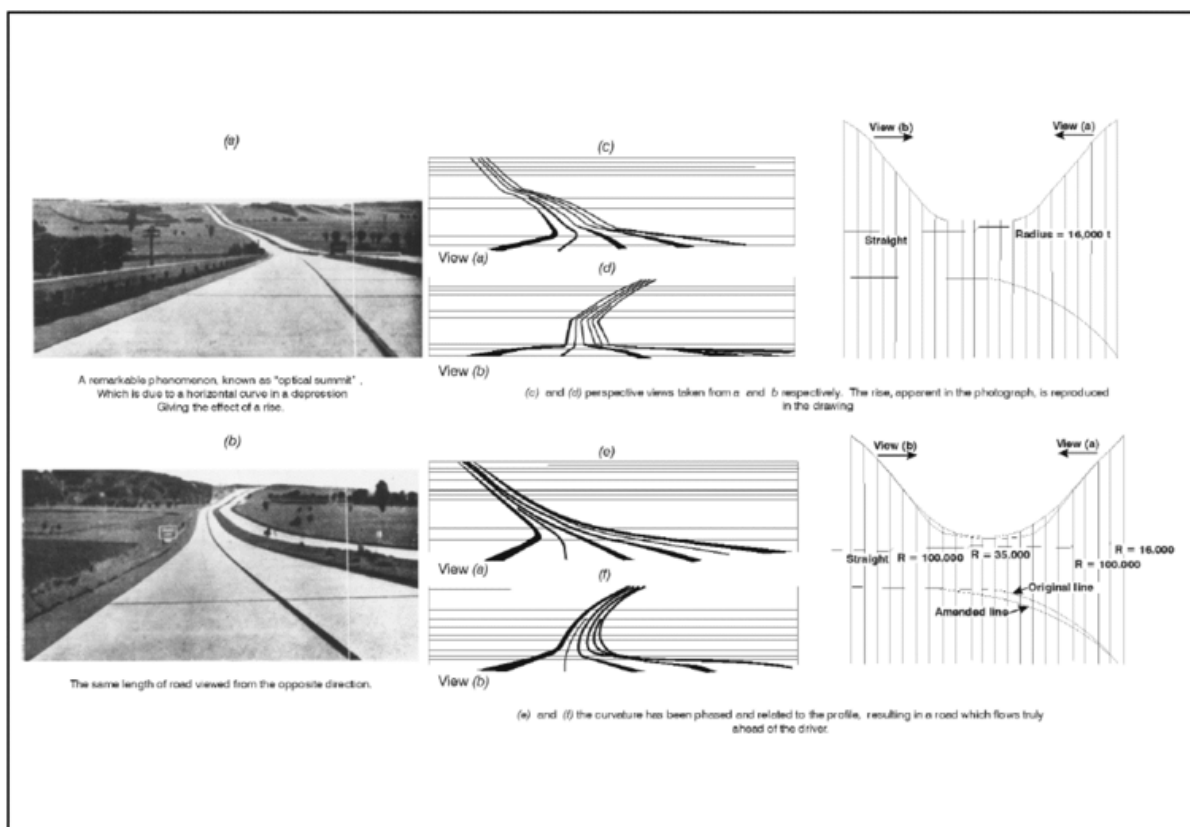

6.3.4 Skyline cuts

There is no equivalent Section 6.3.4 in Austroads *Guide to Road Design – Part 3*.

New

Skyline cuts occur when a straight road cuts through a distant hill creating a distinct break in the line of the ground on the skyline. Particularly on large cuts, such geometry creates a jarring note in the aesthetics of the countryside and should be avoided especially if the horizontal alignment curves on the other side. If such a cutting cannot be avoided, a combination of approach horizontal and vertical curvature should be applied so that the ground line appears continuous through the cut slopes remaining visible to the approaching driver. The continuously evolving cut slopes also provide an indication of the direction of the road beyond the crest of the hill to the approaching driver.

The coordination of the horizontal and vertical design should be over as long a length of road as possible, as discontinuities in appearance can occur even though the shorter lengths, taken in isolation, are satisfactory (Figure 6.12 in *Austroads Guide to Road Design – Part 3*).

6.4 Drainage considerations

Difference

The content of this section is to be considered informative. Drainage criteria are covered in the Transport and Main Roads RDM, which has precedence over the *Austroads Guide to Road Design – Part 5, 5A and 5B*.

7 Horizontal alignment

7.1 General

Addition

Table 7.1 can be used as a planning guide when selecting a horizontal alignment which will result in the desired speed being maintained throughout the length of the road section. The desired speed will typically be equal to the speed limit plus 10 km/h where the adopted posted speeds are credible and have a high probability of being obeyed.

Such roads provide a high quality of service for all drivers and except for exceptional constraints, all geometric elements have a uniform design speed. Normally, high speed roads are used:

- where the high standard geometrics are compatible with the terrain
- where the importance of the road justifies the additional costs of achieving the added quality of service.

Table 7.1 – Typical minimum radius for planning purposes

Road Type	Proposed Speed Limit (km/h)	Typical Minimum Radius (m) that will not reduce Desired Speed
Motorways	80	450
	100	600
	110	800
High Speed Rural Roads	100	600
	110	800
Urban Arterial and Sub-arterial Roads	60	200
	70	275
	80	300

Difference

The 2nd sentence in the 5th paragraph of *Austroads Guide to Road Design – Part 3*, is replaced as follows:

It is not accepted practice to reduce the posted speed for isolated geometric deficiencies. For guidance on the signing of speed limits and advisory warning signs in these circumstances, refer to the Transport and Main Roads Queensland MUTCD.

The evaluation of the design under EDD conditions is not accepted as there are no EDD design criteria for horizontal curves.

7.4 Circular curves

7.4.1 Horizontal curve equation

Addition

Where a curve has adverse crossfall, the value of 'e' in equation 5 will be negative.

7.5 Types of horizontal curves

7.5.1 Compound curves

Addition

Replacement of compound curves can be achieved through:

- Judicious rearrangement of the position of the pavement on the existing formation width with a suitable radius.
- Create a broken back curve by changing the radius of the curves to create a short length of straight ($<0.6V$) between the tangent points of the curves.

Where existing compound curves cannot be reconstructed immediately, interim treatments should focus on advising the approaching drivers and riders of the sub-standard geometry to assist them in the selection of an appropriate approach speed. Such treatments include additional signage and closely spaced edge guide posts.

Where compound curves are retained visualisation drive through software provides the opportunity to ensure that the changes in radius is obvious to approaching drivers.

Compound curves should only be retained where:

- the designer is confident that the curve will not be overdriven in either direction resulting in drivers crossing either the centre or edge lines, and
- on a single direction carriageway where the compound curve transitions from a smaller radius to a large radius.

7.5.2 Broken back curves

Addition

Visualisation drive through software should also be used for the review of the design of broken back curves, in particular to review the length of straight required to ensure the second curve is obvious to approaching drivers.

7.5.4 Transition curves

Difference

Austroads Guide to Road Design – Part 3 contains an error in Step 7 of the design procedure for spiral curves. Reference to Equation A 20 is to be changed to refer to Equation A 21.

Addition

Redesign of existing roads without transitions may result in significant relocation (and cost) of the roadway if an attempt is made to insert a transition. The preferred alternative is to consider a slight

reduction to the curve radii when inserting the transition to minimise realignment as shown in Figure 7.5.4. Surface correction may be required to ensure superelevation is applied correctly.

Figure 7.5.4 – Introducing transitions onto existing curves without transition

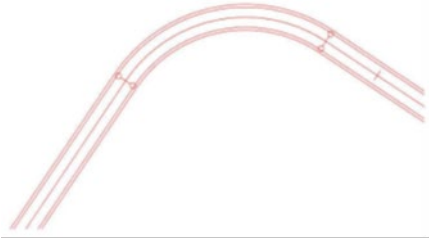
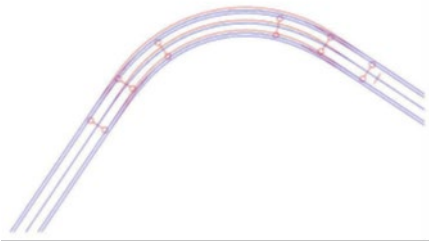
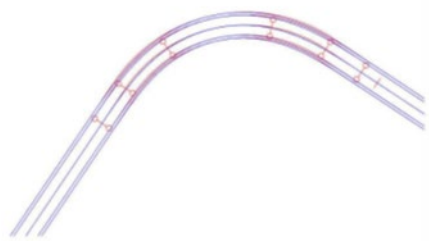
	<p>a) Curve with no transition</p>
	<p>b) Transitioned Curve superimposed on original untransitioned curve; radius reduced by shift to accommodate transition (usually less desirable)</p>
	<p>c) Transitioned Curve superimposed on original untransitioned curve; radius reduced to maintain same secant leaving minor 'redundant' width on outside of new transitions (more desirable)</p>

7.6 Side friction and minimum curve size

Addition

For further discussion on the design of curves to manage undue increases in the side friction demand between successive curves, refer to Section 3.6.6.

The maximum side friction factors to be used on unsealed roads are provided in Table 7.6. However, it is critical in these situations that there is a high degree of confidence in the likely operating speed on these roads as a small increase can lead to a substantially higher side friction demand which may exceed that provided.

Table 7.6 – Maximum side friction factors for unsealed roads

Speed	50	60	70	80	90	100	110
Max. coefficient of side friction	0.12	0.11	0.10	0.10	0.09	0.09	0.08

7.7 Superelevation

Addition

In constrained situations such as mountainous terrain or urban roads, curves should be fully superelevated even if only at a single point. But it is desirable that there be at least 30 m of fully superelevated curve.

Major changes in side friction demand between successive horizontal curves is to be avoided when deciding on the required superelevation to be applied to a horizontal curve.

7.7.3 Maximum value of superelevation

Addition

Values of superelevation up to 10% may also be used in special cases where existing pavement or kerb lines are to be retained.

On bridges, the maximum superelevation is 5% on urban roads and 6% on rural roads.

On a floodway that is located on a horizontal curve superelevation must be kept below 5%.

7.7.6 Length of superelevation development

Addition

It has not been Queensland practice historically, to specify a rounding vertical curve or 'ease' in association with superelevation development (although there are some examples where this has been done on major motorway projects). The appearance at such locations is generally addressed through the relative grade criteria. However, where kerb and channel or roadside barrier is present, it is good design practice to check the resultant profile of these objects to make sure its appearance has not been compromised. Visualisation using 3D modelling is suitable for this and may require some minor adjustments.

7.7.10 Positioning of superelevation runoff without transitions

Addition

Queensland practice is to apply 50% of the superelevation runoff length on the tangent and 50% on the curve.

However, it is recognised that in some circumstances, different arrangements will be appropriate:

- In constrained situations (such as mountainous areas or urban roads) shorter than desirable arc lengths may force the positioning of superelevation runoff to be 70% on the tangent and 30% on the curve.
- 100% development of the superelevation on the tangent for an un-transitioned curve is not preferred but may be accepted in exceptional circumstances as described in *Austroads Guide to Road Design – Part 3*.

Broken back curves

Superelevation on a broken back curve should be treated as per Figure 7.7.10.

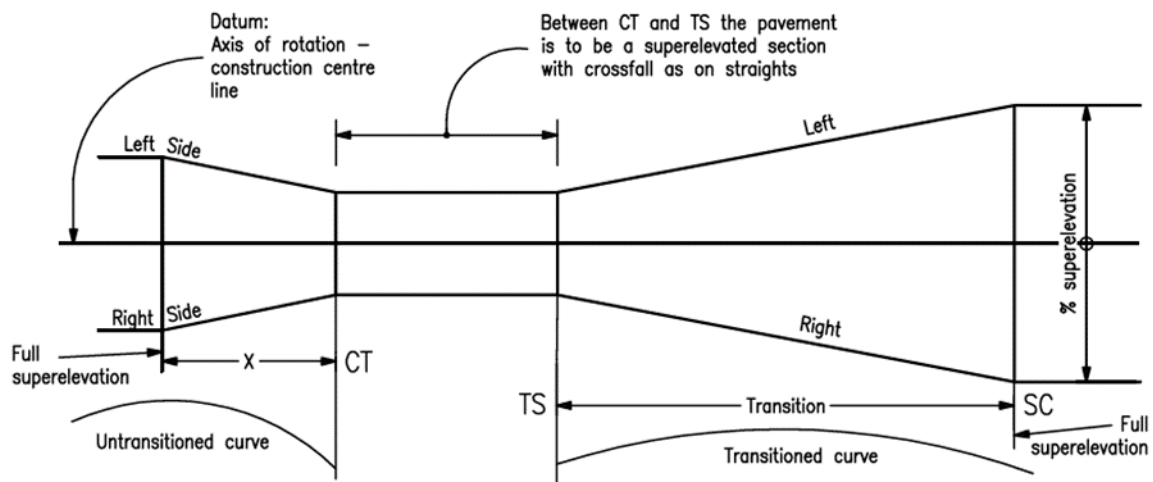
Figure 7.7.10 – Superelevation development for broken back curves

General treatment of similar curves when distance between tangent points $< 3V$ metres (V in km/h)

7.7.13 Development of superelevation to avoid drainage problems

Addition

The Transport and Main Roads RDM details the method to calculate water film depths and also provides a calculation spreadsheet.

One of the most common places that excessive water film depths may occur is at superelevation transitions associated with horizontal curvature or on steep roads where long flow paths are created. Care is required where the combination of geometric elements, vertical grade, horizontal curvature and superelevation, can lead to increasing the depth of water on the pavement surface. In the change from a normal crossfall to superelevation, the combination of the crossfall / superelevation and longitudinal grade must be assessed to ensure that situations where aquaplaning may occur are avoided.

Also, a major problem will typically be where the flow path changes direction to cross back across to the other side of road as the flow path grade will be flatter at this point.

Water flowing across the surface can be a hazard (e.g. aquaplaning may result) if:

- it deposits material on the road surface (e.g. gravel, sand)
- a driver enters the flowing water at too high a speed, and/or
- the water is too deep for safe navigation by vehicles (e.g. from overland flow onto the road).

Material deposited on the road by water flowing across it can be a hazard, particularly where the side friction demand is high. It will also be particularly hazardous to vulnerable road users, such as motorcyclists.

Where depths exceed the limits (even desirable limits) defined by the RDM the following summary of treatments should be considered:

- Regrade – modify the vertical alignment so that the longitudinal grade is increased at the location of the superelevation transition. An increased grade will help the water to flow faster off the pavement. When crest vertical curves are introduced into the road to increase the

grade along the water flow path, care needs to be exercised to ensure that the start of a horizontal curve is not concealed to drivers.

- Relocate – consider relocating the superelevation transition a short way away from the horizontal curve to a location with more longitudinal grade. Relocations of 50 m would be considered acceptable (absolute 100 m). Note that superelevation runoff should not be taken more than one second of travel (maximum 30 m) into the curve. Refer to Section 7.7.10 of *Austroads Guide to Road Design – Part 3*.
- Increase the rate of rotation – a designer may consider increasing the rotation rate to shorten the flow path length. Rotation rates of up to 3% per second may be considered on motorways as an acceptable trade-off to reduce water film depths. In this instance it is especially important to ensure that a well justified design speed is adopted. Also, it is necessary to use visualisation tools to ensure that there is no appearance issue with relative grade between the carriageway edges.
- Individual lane rotations – are an EDD design treatment (refer to Appendix A).
- Pavement texture depth – using a pavement with a higher texture depth can reduce water film depths but it is necessary to consider that a future pavement overlay may adopt a surface with a smaller texture depth (e.g. a chip seal may be replaced with an asphalt overlay).
- Diagonal or wandering crown – is an EDD treatment (refer to Appendix A).
- Adverse crossfall – if the horizontal curve radius is large enough, there may be scope to leave the curve unsuperelevated, that is, to have adverse crossfall – see Section 7.8. This avoids the need for a superelevation transition. This is one of the primary reasons why large curvature should be considered for greenfield motorways.

Note that combinations of the above methods may be used. For example, a designer may choose to increase the rate of rotation and apply individual lane rotations.

Some of these methods to reduce water film depths are easier to implement during the concept stages of a project and therefore this is the reason why aquaplaning should be assessed at this time. As a quick rule of thumb, superelevation transitions on less than 1.5% longitudinal grade are prone to excessive water film depths and further investigation should be undertaken during the concept stage.

Some of the methods listed above are not common methods to apply superelevation. To ensure that future maintenance personnel have the required information, details of the aquaplaning treatments, the dot points listed above should be shown on the relevant plans (including general arrangement and long sections). This will help ensure that the treatment is reinstated through the maintenance process.

The plans should also show details of the tolerances expected during construction. Tighter construction tolerances are expected in locations where design effort has been used to reduce water film thicknesses.

7.8 Curves with adverse crossfall

Addition

It is normal practice to superelevate all horizontal curves. However, there are situations where the application of superelevation can cause pavement drainage problems, for instance, when the grade is nearly flat, water will not run off the road properly at places where the crossfall is also nearly flat. This can result in safety issues through the risk of aquaplaning, as well as in potential maintenance

problems. In such circumstances, if the horizontal curve radius is large enough, there may be scope to leave the curve unsuperelevated, that is, to have adverse crossfall. See also Section 7.11.

With adverse crossfall, there is a component of the vehicle weight that acts opposite to the centripetal force that is needed for the vehicle to move in a circular path. This in turn requires greater side friction than for a curve of given radius with positive superelevation if the vehicle is to take the curve at the same speed. Further problems with using adverse crossfall are:

- Greater tendency of vehicles to move towards the outside (in terms of radius) of the traffic lane on multilane roads.
- Greater instability of vehicle loads. This is also exacerbated by greater suspension movement due to the weight component acting in the outwards direction.
- On two-lane, two-way roads, the normal crowned pavement structure is carried through the curve. Vehicles on the outer lane will have adverse superelevation and vehicles on the inner lane will have positive superelevation. Hence, a vehicle that crosses from the inner lane to the outer lane will experience a rapid increase in side friction demand with increased probability of the driver losing control.
- Adverse crossfall results in greater reliance on motorcycle tyres grip to negotiate a curve. Further, it reduces the amount of 'lean' a motorcyclist can use to negotiate a curve. The combination of both of these issues can result in a motorcycle losing its stability and grip in a curve.

For these reasons, when addressing drainage issues on motorways or higher speed rural roads (design speed ≥ 70 km/h), the horizontal curve radii that can have adverse crossfall (based on 3% crossfall) should desirably be greater than or equal to the radii given in Table 7.8 below. In constrained situations on motorways or higher speed rural roads, horizontal curve radii less than those given in Table 7.8 but greater than or equal to those given in Table 7.12 of *Austroads Guide to Road Design - Part 3*, may be considered for adverse crossfall (based on 3% crossfall), with appropriate justification provided.

Table 7.8 - Motorways and high-speed rural roads – Desirable minimum horizontal curve radii that can have adverse crossfall (based on 3% crossfall)

Design Speed	Minimum Radius (m)
70	900
80	1250
90	1500
100	2000
110	3000
120	4000
130	5000

Difference

In the 3rd paragraph the term one-way crossfall is replaced with the term adverse crossfall.

In the 5th and 7th paragraphs the term adverse superelevation is to be replaced with the term adverse crossfall.

7.9 Pavement widening on horizontal curves

Addition

Curve widening is to be based on the design vehicle for the section of road. The only exception to this requirement is on climbing / descending lanes on multi-combination vehicle routes where the outer lane is designed for this vehicle while the adjacent lane in the same direction only needs widening to suit a single unit truck / bus.

Curve widening is applied by tapering the widening over the length of the roadway used for superelevation runoff. In the case of a transitioned curve, the superelevation runoff corresponds with the plan transition. In the case of an un-transitioned curve, it is usually applied equidistant about the tangent point of the horizontal curve.

It is not acceptable to retain the normal lane dimension around the curve on the basis that the lane width on the curve is within the width allowed on some sections of the network (e.g. approach 3.5 m lane retained through the curve on the basis that the 3.5 m is equivalent to a 3.2 m lane with 0.3 m widening). The vehicle approaching the curve will not adjust its position in the lane to accommodate the required movement in the curve. It will therefore encroach on the adjacent lane.

Due to the size of the current design vehicles, the curve widening results in wide traffic lanes for curves with a radius less than about 100 m. However, at traffic flows greater than about 1000 vehicles per hour, cars tend to form two-lanes within traffic lanes greater than about 4.6 m wide. The width at which two-lane operation starts to occur is also dependent upon the horizontal curvature - this width approaches 10 m in the case of a circulating roadway of a roundabout.

Therefore, in practice, potential problems with wide traffic lanes due to curve widening are only likely to occur in urban areas. However, due to right of way constraints in urban areas, it will often not be possible to provide full curve widening for road train, B-double operation or even semi-trailer operation.

7.10 Curvilinear alignment design in flat terrain

7.10.1 Theoretical considerations

Difference

In the fifth paragraph, Austroads *Guide to Road Design – Part 3* incorrectly refers to 'at least 30 degrees of deflection angle as a minimum'. The correct angle is 'at least 3 degrees of deflection angle as a minimum'.

8 Vertical alignment

8.1 General

Addition

The department requires that vertical curves are defined using the K value. The notation to be applied is to define a curve with the capital letter 'K' before the value of the vertical curve (for example K90).

8.2 Vertical controls

8.2.1 General

Addition

In addition to the list of typical controls for vertical geometry listed in Austroads *Guide to Road Design – Part 3* the following items also control the vertical alignment:

- maximum allowable grades
- minimum size of vertical curves
- earthworks balancing
- alignment appearance and aesthetics
- environmental impacts, and
- coordination with horizontal alignment.

In flat country where the road grade is close to the natural ground level, grids and drainage pipes cannot be effectively placed such that they are below the normal grade line of the road. To do so would create drainage problems as the base of the grid and the invert of the pipe would be below the surrounding countryside. In these cases, the road has to be graded over the grid or pipe to allow them to function and to provide adequate cover to the pipe.

8.2.3 Flood levels or water table

Addition

The content of this section is to be considered informative. Drainage criteria is covered in the Transport and Main Roads RDM, which has precedence over the Austroads *Guide to Road Design – Part 5, 5A and 5B*.

8.2.4 Vertical clearances

Addition

Departmental requirements for vertical clearance for objects constructed over a road is to be guided in the first instance by the Transport and Main Roads *Design Criteria for Bridges and Other Structures*.

8.2.7 Vehicle clearances

Difference

Queensland practice is to use AS/NZS 2890.1 to assess driveways with regards to private car access. The content in Section 8.2.7 of Austroads *Guide to Road Design – Part 3* contained within the 'Car Template' subsection and Figure 8.4 are not to be used.

8.3 Grading procedure

Difference

Drainage criteria are covered in the Transport and Main Roads RDM which has precedence over the Austroads *Guide to Road Design – Part 5, 5A and 5B*.

8.4 Grading point

8.4.2 Divided roads

Addition

When deciding on the grading point(s) for divided roads, the following principles apply for roads where the median width is less than or equal to 8 m, or are up to 15 m and where future lane additions are proposed in the median:

- the adjacent median shoulder edges should either be level (refer Figure 8.4.2(a)), or
- follow a single crossfall across the entire carriageway (refer Figure 8.4.2(b)).

These principles assist in:

- Attaining flatter batter slopes for medians.
- Achieving a consistent median section.
- Allow for extra lane(s) to be added into the median with standard double-sided concrete barrier installation and still achieves a solution that is safe and economical. Median water discharge intervals are a critical design issue when fixing median profiles.

If constrained it is preferred to grade each carriageway to accommodate a concrete barrier without variations in the heights between the two carriageways.

However, in some circumstances differential grading may be adopted for each carriageway due to economics and/or environmental considerations. Non-parallel horizontal alignments may be required to cater for additional median width required to accommodate cut / fill slopes. These features of design are most likely to occur in rugged terrain and it is therefore important to ensure appropriate consideration is given at this stage for any future carriageway widening, such as adding additional lanes.

Figure 8.4.2 – Grading point process for divided roads

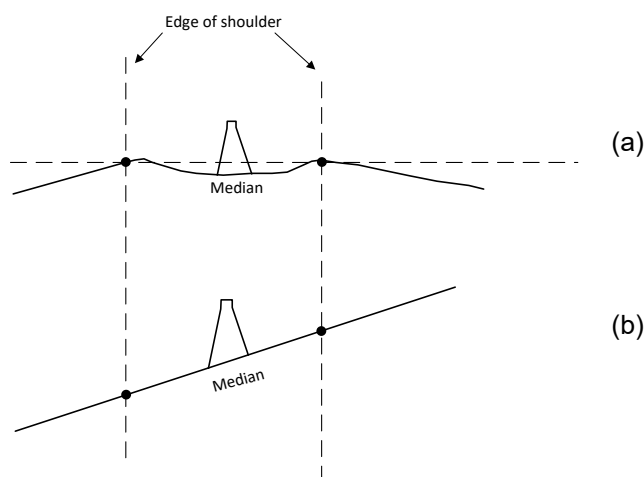

8.5 Grades

8.5.1 General

Additions

When setting gradients for new urban or urbanising roads, road gradients should permit accessible paths of travel to be implemented where feasible. Universal access shall be considered in project development even in areas where topography is challenging. Refer RPDM Vol 3 Part 6A, Section 5.4 for further guidance on gradients for universal access in retrofit scenarios.

Difference

Drainage criteria are covered in the Transport and Main Roads RDM which has precedence over the Austroads *Guide to Road Design – Part 5, 5A and 5B*.

8.5.3 Maximum grades

Addition

In addition to the content of Table 8.3 in Austroads *Guide to Road Design – Part 3* the following criteria should be considered.

- On roads with operating speeds of 50 km/h the following general maximum grades apply.

Flat	Rolling	Mountainous	
		< 2,000 AADT	2,000 - 5,000 AADT
6 – 8	8 – 10	12	10

- On mountainous roads with AADT of:
 - 2,000 to 5,000 overtaking lanes may be required depending on overtaking opportunities and percentage commercial vehicles.
 - 5,000 to 10,000 overtaking lanes are recommended where overtaking opportunities are occasional and the component of commercial vehicles is $\geq 5\%$.
 - Greater than 10,000 a four-lane divided cross-section should be investigated.
- The maximum design grade should be used infrequently, rather than as a value to be adopted in most cases.

8.5.4 Length of steep grades

Addition

The computer simulation program VehSim is preferred to assess the design vehicle performance on grades. The figures provided in Austroads *Guide to Road Design – Part 3* may be used as a guide in the first instance.

8.5.5 Steep grade considerations

Addition

On steep grades combined with successive curves in opposite directions, the combination of grade and pavement rotation can result in the flow path meandering from one side of the road to the other and the depth of flow becoming excessive. Superelevation sections should always be checked to ensure that the flow depths do not exceed the values specified in the Transport and Main Roads RDM.

On steep grades, the potential relative speeds should be minimised between faster lighter vehicles and slower heavier vehicles to minimise rear-end accident rates. Such grades typically occur in mountainous terrain and the design should aim to achieve a relatively low (recommended maximum 80 km/h) desired speed using horizontal geometry. Where the horizontal geometry cannot be used to limit the desired speed, the alignment must provide better than the minimum standard of visibility to any slow-moving vehicles in the lanes ahead. In these situations, the sight distance should be increased above those defined in Table 5.2 of Austroads *Guide to Road Design – Part 3* to allow for an additional 1 second driver reaction time.

8.5.6 Minimum grades

Addition

Very flat grades can occur on sections of superelevation development when the longitudinal grade is less than 1.5%. These should always be checked to ensure that the flow depths do not exceed the values specified in the Transport and Main Roads RDM.

Difference

In the 4th paragraph and Table 8.5 of Austroads *Guide to Road Design – Part 3*, in difficult circumstances an absolute minimum longitudinal grade of 0.3% may be adopted for roads with kerb and channel.

8.6 Vertical curves

8.6.3 Crest vertical curves

Addition

Unnecessarily large crest curves can become an issue on high speed roads by limiting the length of road providing suitable overtaking opportunities.

For 'Sight distance criteria (crest)' and Note 8 to Table 8.7 in Austroads *Guide to Road Design – Part 3*, the use of a coefficient of deceleration of 0.26 is not generally to be used in Queensland on State Government roads.

8.6.4 Sag vertical curves

Difference

Drainage criteria is covered in the Transport and Main Roads RDM which has precedence over the Austroads *Guide to Road Design – Part 5*, 5A and 5B.

8.6.6 Reverse / compound / broken back vertical curves

Difference

In the 2nd sentence in the first paragraph the tolerable allowance for riding comfort, 'a' is 0.05 g m/sec², or 0.1 g m/sec² as appropriate as described in Section 8.6.5 of Austroads *Guide to Road Design – Part 3*.

Equation 25 is replaced with the following to use the more general variable 'a' for acceleration.

$$a > \frac{V^2}{1296} \left[\frac{1}{K_1} + \frac{1}{K_2} \right]$$

Equation 26 in *Austroads Guide to Road Design – Part 3* has an additional equal sign '=' incorrectly inserted. The equation is replaced with the following:

$$K \left[\frac{K_1 + K_2}{K_1 K_2} \right] \leq (1 + b)$$

The value for K in Equation 26 is derived from Equation 20, not from Figure 8.9.

8.6.7 Minimum length of vertical curves

Addition

With respect to the 2nd paragraph, it is not a requirement that vertical curves must be provided at all changes of grade on the main alignment of major roads, providing the criteria in Table 8.12 of *Austroads Guide to Road Design - Part 3*, are met. However, it would be desirable to do so, where practical.

With respect to the 3rd and 4th paragraphs, judgment in respect to whether or not the appearance of a vertical curve is acceptable should be made through the use of 3D visualisation software.

9 Auxiliary lanes

9.4 Overtaking lanes

9.4.1 General

Difference

Location

Overtaking lanes within 3 km of a town are permitted in the direction heading away from the town.

In *Austroads Guide to Road Design – Part 3*, with respect to Figure 9.5: Details of painted island for right side widening, line marking is to be in accordance with the Transport and Main Roads Queensland MUTCD.

Addition

Overtaking lanes and accesses or turnouts to the right

Overtaking lanes are constructed to provide road users with an opportunity for unhindered overtaking of slower vehicles. There is an expectation by drivers that slowing or stopped vehicles will not obstruct this overtaking manoeuvre. For this reason, it is highly undesirable to have right turning vehicles from the overtaking lane.

Slowing or turning vehicles should not compromise vehicle use of overtaking lanes.

When siting overtaking lanes the presence and location of accesses and turnouts needs to be considered and appropriate facilities provided. When accesses or turnouts are located to the right of the overtaking lane the following steps need to be followed:

1. Assess the access / turnouts usage (volume and vehicle type, seasonal or slow).
2. Consult with owner or LGA on current usage and future potential.

3. Assess the risk of right turn to the access / turnout from the overtaking lane.
4. Can the overtaking lane be relocated to avoid the access / turnout? If so, determine a more viable location.
5. Can the access or turnout be closed to use? If so, close the access / turnout following consultation.
6. Can right turn access be prevented by linemarking or median? If so, provide appropriate barrier and construct a U-turn facility clear of the overtaking lane. Consideration needs to be given to the amount of extra travel to carry out this manoeuvre. 1.5 minutes of travel with a maximum distance of 1.5 km is considered to be acceptable (a), (b) and (c) in Figure 9.4.1(A).
7. Can the access or turnout be relocated beyond the overtaking lane? If so, construct in new location.
8. Can the accesses or turnouts be rationalised and collected by a service road with the egress relocated beyond the overtaking lane? Construct service road and new entry beyond the overtaking lane.
9. Even after all those considerations it may still be necessary for the overtaking lane to remain at this location. Should this be the case then appropriate right turn protection [Figure 9.4.1(A)(e)] or pull over to the left [Jug Handle, Figure 9.4.1(A)(d)] to create a road crossing is to be provided. The jug handle facility within the overtaking lanes is for passenger and light commercial vehicles only. It is not suited to the larger heavy and slow-moving vehicles due to the time to cross the lanes. Note that sight distance to this facility must be at least safe intersection sight distance. Locating these lanes on left hand curves should be avoided because of the difficulty of providing adequate visibility.
10. Service road collection, U-turn facilities and left pull overs are shown in Figure 9.4.1(A). Figure 9.4.1(B) provides a flow chart for this process.

Right turns that are downstream of an overtaking lane can also cause problems for the traffic flow. At worst, they can provide a higher degree of hazard due to the combination of a vehicle that is stopped while waiting to turn and the increased speed of the through traffic. Right turning vehicles may also cause traffic bunching to reform prematurely.

The desirable minimum spacing is 15 seconds of travel past the end of the merge taper. This is based on:

- 5 seconds travel time until the driver is faced with a new decision after the merge
- 3 seconds travel time to see and comprehend a right turn sign, and
- 7 seconds travel time to accommodate the standard spacing of the right turn sign before the intersection.

At this spacing, even though traffic flow may initially be compromised when there is a turning vehicle, the right turn is still likely to be within the zone where headways are being re-established after the overtaking lane. This means that it is unlikely that bunching will reform prematurely.

Figure 9.4.1(A) – Overtaking lanes and accesses or turnouts on right

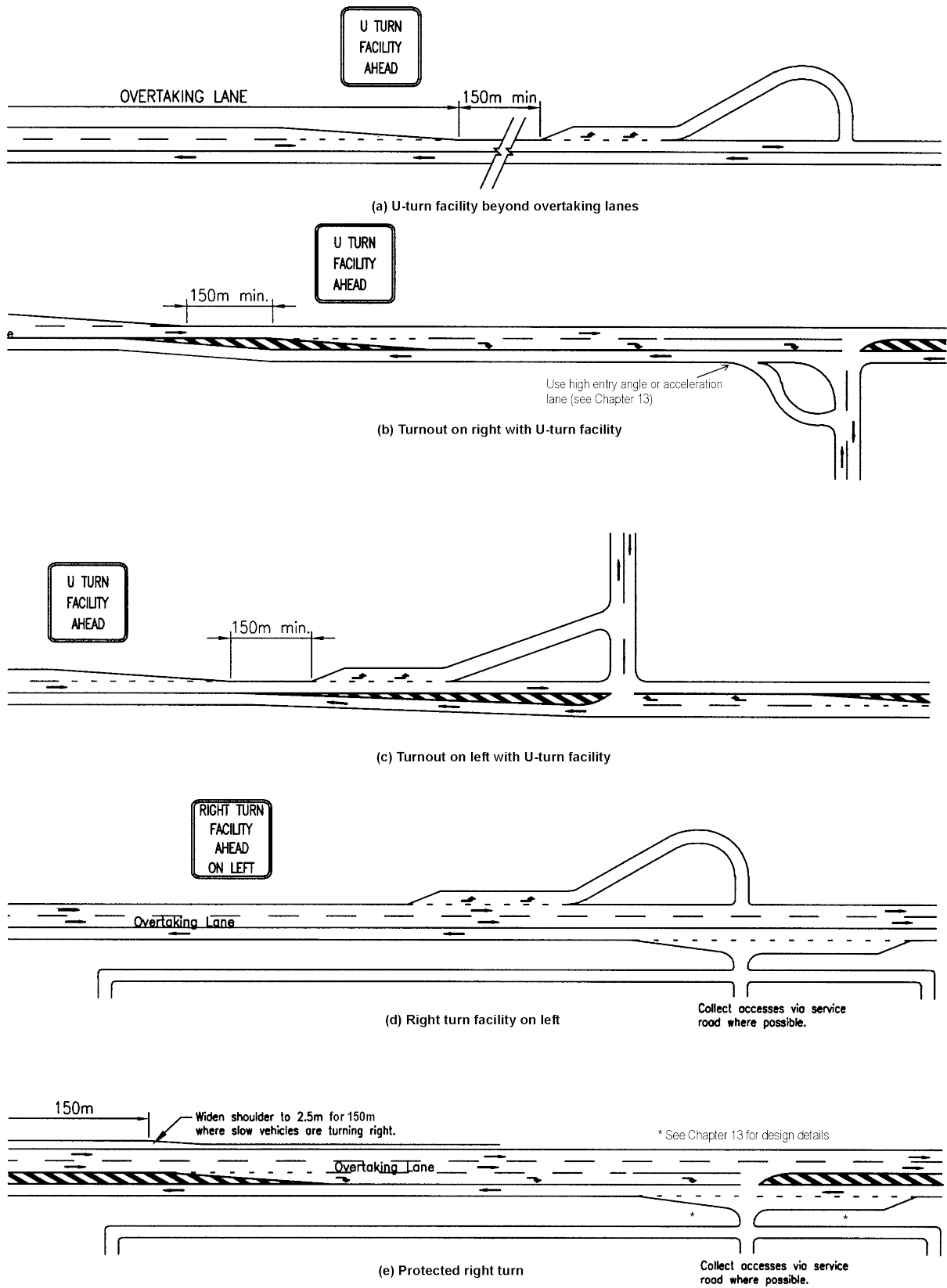
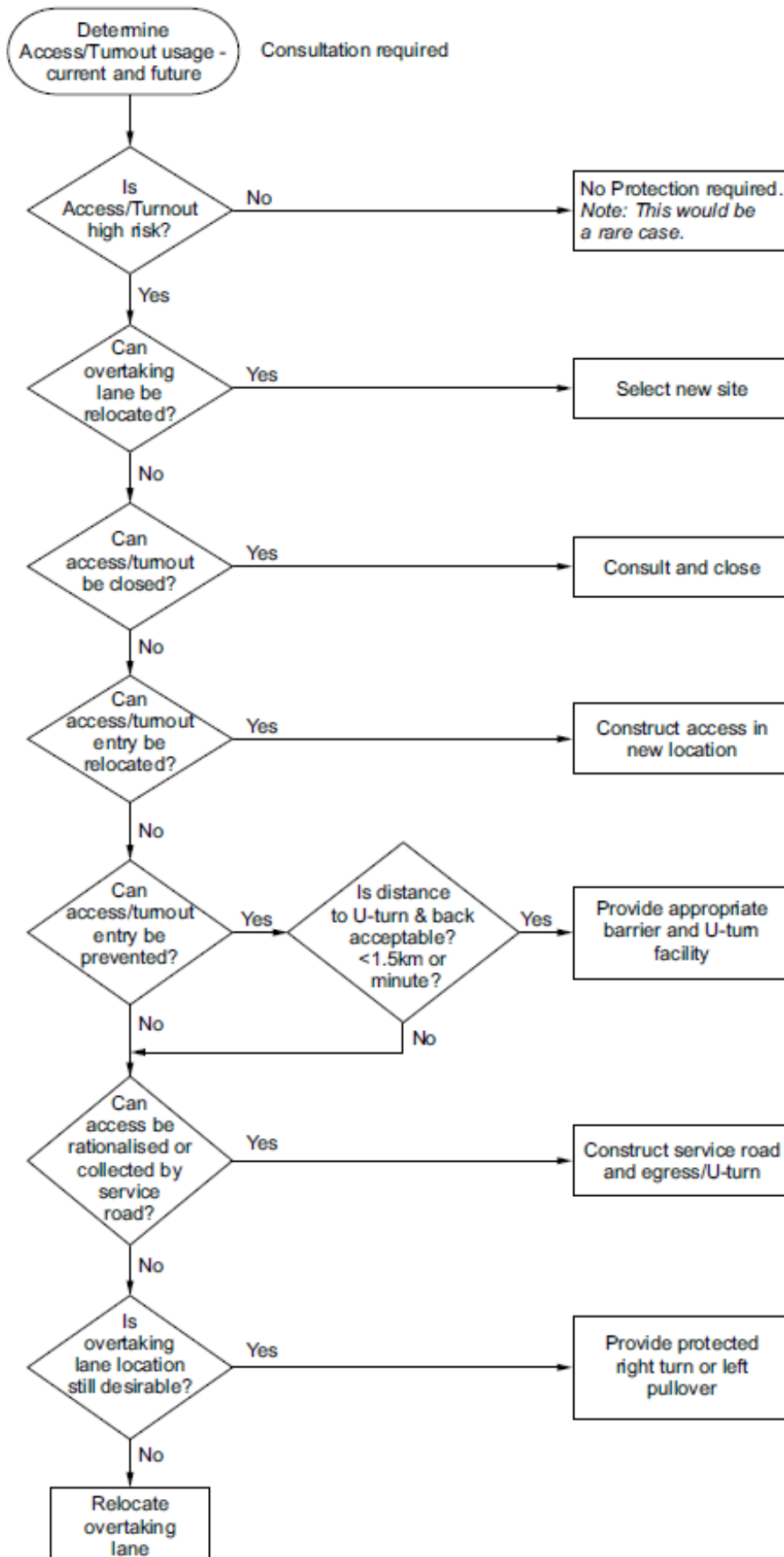

Figure 9.4.1(B) – Flow Chart – Overtaking lanes and accesses or turnouts on right



9.5 Climbing lanes

9.5.2 Warrants

Addition

For multi-lane roads, specific analysis using VehSim and level of service assessment is required to determine the need for climbing lanes.

9.9 Geometric requirements

Addition

Overtaking lanes are to be designed for a design speed 10 km/h above the design speed on the adjacent sections of road. This is termed the overtaking design speed.

- The geometry of merge and diverge areas are to be designed for the overtaking design speed.
- In other areas of the overtaking lane, a design check should be undertaken to see if suitable capability exists for the overtaking design speed.
- Overtaking design speed applies to but is not limited to the design of:
 - Sight distance, most specifically to the rear of other vehicles. The additional lane provides increased opportunity for drivers to avoid smaller hazards.
 - Superelevation and limiting curve speed on horizontal curves, and
 - Roadside barrier need and design.

9.9.1 Starting and termination points

Addition

At the start of the overtaking lane a common behaviour observed is rapid acceleration of the tailing driver to pass the slower moving vehicle. At this point, the demand for friction between the tyres and the pavement is higher. This is a primary contributing factor of crashes at overtaking lanes.

Grades in excess of the following should be avoided at the start and termination of overtaking lanes:

- 6% on horizontal curves where the desirable maximum side friction is exceeded.
- 10% on straights and horizontal curves where the desirable maximum side friction is not exceeded.

Where these are difficult to achieve, the designer should look to move the start point away from the steep section of grade to further away from a horizontal curve. These steeper grades are also more appropriately marked as a climbing lane as opposed to an overtaking lane.

9.9.2 Tapers

Difference

Merging taper

Change wording in the 3rd paragraph of the Austroads *Guide to Road Design – Part 3* to:

The run out area provided through the merge area is achieved by maintaining a total pavement width in the direction of travel equal to at least the sum of the full lane width plus a sealed shoulder width of 3 m over the full length of the taper plus 40 m (minimum 30 m) (Figure 9.4 of Austroads *Guide to Road Design – Part 3*).

10 Bridge considerations

10.2 Cross-section

Addition

For guidance on bridge cross-sections refer to Transport and Main Roads *Design Criteria for Bridges and Other Structures*.

10.4 Vertical geometry

Addition

On bridges, consideration should be given to use of a K value vertical curve larger than the minimum required. This is due to the reduced offset from the tangent to the vertical curve to the bridge deck allowing the offset to be taken up in the deck wearing surface as opposed to the bridge structure.

References

Transport and Main Roads publication references refer to the latest published document on the departmental website (www.tmr.qld.gov.au).

Addition

Austroads (2013) *Expanded Operating Speed Model, AP-T229-13*, Austroads, Sydney, NSW

Austroads (2014) *Cycling Aspects of Austroads Guides*, Austroads, Sydney, NSW

Austroads (2021) *Guide to Road Design – Part 3 – Geometric Design*, Sydney, NSW

Heimbach, C, Cribbins, P & Chang, M. (1983). *Some partial consequences of reduced traffic lane widths on urban arterials*, Transportation Research Record, no. 923, pp. 69-72

Hildebrand, Eric D., Frank R. Wilson and James J. Copeland (2005). *Supplemental Speed Reduction Treatments for Rural Work Zones* (in Hennessey, Dwight A and David L. Wiesenthal (2005): *Contemporary Issues in Road User Behaviour and Traffic Safety* (Nova Science Publishers, New York))

SKM (2011). *Sydney Road Bicycle Lane Monitoring* (Draft report for VicRoads)

Standards Australia AS/NZS 2890.1 *Parking Facilities – Part 1: Off-street car parking*

Transport and Main Roads *Cycling Infrastructure Policy*, Brisbane, QLD

Transport and Main Roads *Design Criteria for Bridges and Other Structures*, Brisbane, QLD

Transport and Main Roads *Environmental Processes Manual*, Brisbane, QLD

Transport and Main Roads *Fauna Sensitive Road Design*, Brisbane, QLD

Transport and Main Roads *Geotechnical Design Standard – Minimum Requirements*, Brisbane, QLD

Transport and Main Roads *Queensland Manual of Uniform Traffic Control Devices* (Queensland MUTCD), Brisbane, QLD

Transport and Main Roads *Pavement Design Supplement*, Brisbane, QLD

Transport and Main Roads Technical Note 163 *Third Party Utility Infrastructure Installation in State-Controlled Roads Technical Guidelines*, Brisbane, QLD

Transport and Main Roads *Public Transport Infrastructure Manual* (PTIM), Brisbane, QLD

Transport and Main Roads *Queensland Guide to Traffic Management* (QGTM), Brisbane, QLD

Transport and Main Roads *Road Drainage Manual* (RDM), Brisbane, QLD

Transport and Main Roads *Road Landscape Manual*, Brisbane, QLD

Transport and Main Roads *Road Maintenance Performance Contract* (RMPC), Brisbane, QLD

Transport and Main Roads *Road Planning and Design Manual* (RPDM), Brisbane, QLD

Transport and Main Roads *Road Traffic Air Quality Management Manual*, Brisbane, QLD

Transport and Main Roads *Roads in the Wet Tropics Manual*, Brisbane, QLD

Transport and Main Roads *Route Assessment for Multi-Combination Vehicles (MCV) and Performance Based Standards (PBS) Vehicles in Queensland Guideline*, Brisbane, QLD

Transport and Main Roads *Selection and Design of Cycle Tracks*, Brisbane, QLD

Transport and Main Roads *Standard Drawings*, Brisbane, QLD

Transport and Main Roads *State-controlled Priority Road Network Investment Guidelines* (2011)

Transport and Main Roads *State-controlled Low Priority Road Network Investment Guideline* (2013)

Transport and Main Roads *Technical Notes*, Brisbane, QLD

Transport and Main Roads *Technical Specifications MRTS04 General Earthworks*, Brisbane, QLD

Transport and Main Roads *Traffic and Road Use Management (TRUM) Manual*, Brisbane, QLD

Transport and Main Roads *Traffic Control (TC) Signs*, Brisbane, Qld

Transport and Main Roads *Transport Noise Management Code of Practice*, Brisbane, QLD

Appendix A - Extended Design Domain (EDD) and design exception and potential mitigation strategies for geometric road design

Difference

The title of Appendix A of Austroads *Guide to Road Design – Part 3* is changed to reflect that this Appendix deals with both EDD and design exception and potential mitigation strategies for geometric road design.

A.1 General

Addition

This section also provides design exception values and potential mitigation strategies for geometric road design. These are values outside of the EDD that have been developed through examining current practice in Queensland, other Australian states and other countries.

A.2 EDD and design exception cross-section widths

Addition

The title of Section A.2 of Austroads *Guide to Road Design – Part 3* is changed to reflect that this section deals with design exception for both urban and rural roads.

A.2.1 Urban road widths

Addition

A 1 m wide bicycle lane is an acceptable EDD width for posted speeds of 60 km/h or less.

Lane and shoulder widths

Shoulder widths should not be less than 2 m on the near side and 1 m on the off (i.e. median) side. In some cases, shoulder widths of 2.5 m or 3 m will be justified (e.g. to provide for cyclists or to allow enforcement to take place) but generally shoulders should not be wider than 3 m because some drivers will use the shoulder as another lane, leading to unsafe operation. (Note: A shoulder of 3.5 m or more may be required in special cases where regular law enforcement is required. Care is required in these instances and consideration must be given to the location and extent of such shoulders. A width greater than 3.5 m may be required for enforcement. Where the first stage construction includes only a single two-lane, two-way pavement, the constructed pavement should have lane widths of 3.5 m and two fully paved and sealed shoulders not less than 2 m wide. Through the interchanges, a median is required to separate opposing traffic flows on the motorway. The design shall also take into account the future planning (e.g. radii suitable for adverse superelevation, crown applied to centre of lanes or shoulder as appropriate, layout of ramps suitable for final stage(s) layout, etc.)). This should provide sufficient flexibility to cover likely scenarios to be encountered. Lane widths down to 3 m are allowed with discussion on where best to use any additional width available.

Where lane widths less than EDD values are proposed, a risk assessment will be required and must be treated as a design exception. An important input into the assessment will be the tracking characteristics of the vehicles allowed on that part of the road system (e.g. B-doubles, Road Trains) and the potential increase in crash risk. Further, the risk assessment will need to examine the effects of:

- cyclists
- pedestrians

- motor cyclists
- environmental issues
- capacity at intersections (note that the improvement in level of safety through separate turn lanes far outweighs any potential increase in crash risk because of reduced lane widths), and
- location - i.e. intersection or mid-block – additional width is useful mid-block to allow safer manoeuvring (including lane changing) at normal street speeds. At intersections, protection of turning movements and providing start-up capacity are more important considerations.

Austroads (2010a page 10) notes the following:

Within the range of practical lane widths (say 2.75 to 3.75 m), lane width itself has only a small effect on crash rates for urban arterial roads. The only study to find a statistically significant effect for lane width found crash rates to reduce by 2 to 2.5% per 0.25 m increment in lane width (Heimbach et al. 1983).

Reference to the source document should be made for guidance on details of crash reduction values and how to apply them.

The effect on the operation of bicycles in the narrower lanes should be considered and an appropriate solution determined. Refer to <https://www.tmr.qld.gov.au/business-industry/Technical-standards-publications/Cycling-guidelines> for specific guidance on providing for bicycles on existing urban roads.

It is important to realise that a suitable solution for a specific problem will not necessarily be a simple one and will depend on the specific circumstances at that location.

Where values for carriageway widths less than EDD are proposed, they must be treated as design exceptions with appropriate justification.

A.2.2 Rural two-lane two-way road widths

Difference

Replace the first paragraph of this section with the following:

There are many existing two-lane rural roads in Queensland which do not meet the normal design domain lane and shoulder width criteria in Table 4.2.6(a). Particularly on low volume roads with volumes less than 400 vpd AADT, carriageway widths are often less than the 8.5 m total seal width specified.

Difference

Replace the third and fourth paragraphs, and Table A 2, of this section of Austroads *Guide to Road Design – Part 3* with the following:

The criteria in Table A.2.2 provide EDD values for traffic lane and shoulder widths for two-lane, two-way rural roads in Queensland. The widths listed have been based on the satisfactory operation of such roads over a long period of time and support the retention of existing cross section widths. However, in some cases, the department's investment strategies may require the retention of existing cross section widths for higher traffic volumes than detailed below due to other network priorities.

Observations by the department have determined that where the road is a road train route, the seal width needs to be a minimum of 7.4 m, otherwise the road trains run one wheel off on the shoulder. Further it is recommended that the seal width should be a minimum of 8 m to assist in reduction of gravel loss on shoulders.

The widths listed in Table A.2.2 include fully sealed shoulders. As this table presents EDD cross-section widths, they should only be used with better than minimum values of other geometric parameters at the same location. The widths also apply to straight sections of road. On curves, the requirements for curve widening are still to be applied.

Table A.2.2 – Minimum single carriageway rural road widths (m) – extended design domain

Design AADT	250 – 400	400 – 1000	1000 – 2000		2000 – 4000			> 4000
Road Carriageway Type ⁽¹⁾	All	All	L	N	L	N	H	Rural roads with AADT greater than 4,000 vehicles per day should have a wide centreline and ATLM. Refer to Appendix G for general guidance and in particular Section G.4 for cross section dimensions.
Lane Width	3.00	3.25	3.50	3.50	3.50	3.50	- ⁽⁵⁾	
Shoulders	1.00	1.00	1.00	1.25	1.00	1.50	- ⁽⁵⁾	
Wide Centre Line Treatment							- ⁽⁵⁾	
Carriageway ⁽²⁾	8.00 ⁽⁴⁾	8.50	9.00	9.50	9.00	10.00	- ⁽⁵⁾	
Cycling ⁽³⁾						P		

Notes:

- Road Carriageway formation type:
- L – Low embankments (i.e. < 1 m) on lower order roads where batter slopes do not exceed 1 on 4
N – nominal road values
H – Higher order roads requiring a WCLT
- Full width of seal required.
- A 'P' in these columns indicates cross sections generally considered suitable for 'Priority cycle routes' in rural areas. Otherwise if a route is part of a cycle network, additional sealed shoulder width will be required. Refer to Section 4.3.2 for further details.
- Where a road is subject to the *State-controlled Priority Road Network Investment Guidelines* (2011) or the *State-controlled Low Priority Road Network Investment Guideline* (2013), the interim seal width to be applied is 8 m with allowance for a vision seal width of 9 m.
- Higher order roads with AADT 2000-4000 should have a wide centreline and ATLM. Refer to Appendix G for general guidance and in particular Section G.4 for cross section dimensions.

A.2.3 Design exceptions for rural carriageway widths

There is no equivalent Section A.2.3 in Austroads *Guide to Road Design – Part 3*.

New

With Road Design Class B cross-section widening projects, a design exception will occur wherever proposed values fail to meet the EDD criteria. With Road Design Class C projects involving improvement of the seal width, a design exception will occur wherever the proposed values fail to meet the Transport and Main Road's investment criteria. In all of these cases, the proposal must be justified as described in Section 4. Some comments on possible approaches are provided below.

Less than 12,000 vpd

When retro-fitting an improvement to an existing formation, the most economical arrangement is to retain the edge line, reduce the width of the through traffic lane and apply a WCLT (refer Appendix G). If the WCLT dimensions cannot be achieved, then justification of the arrangement and appropriate mitigation will be required. Mitigation may include flatter batters (flatter than 1 on 4) and safety barriers

(if justified) together with frequent lay-by space – approximate 500 m spacing is required. Mitigation will also include ATLM located adjacent to the painted centreline. This provides an additional 200 mm between the ATLM allowing some additional room for movement in the lane before triggering the audio response from the line. For traffic volumes less than 2000 vpd, ATLM may only be required on the centreline side of the lanes. If run-off-road crashes are prevalent, then the ATLM will be required on both sides of the lane.

More than 12,000 vpd

Duplication of the carriageway is the appropriate solution for roads carrying more than 12,000 vpd. Retention of the two-lane two-way carriageway is therefore a design exception and requires justification. In these cases, a minimum carriageway width of 10 m should be available. If widening of the carriageway is required to retain a two-lane arrangement, the additional costs of traffic management may make construction of a separate carriageway free of traffic an economical proposal thereby removing the need to have a design exception. If the two-lanes are retained, the mitigation measures will include a WCLT together with flatter batters and frequent lay-by areas (not less than 500 m intervals in both directions).

Line marking may include ATLM and be carried out in accordance with the principles shown in Appendix G. At these traffic volumes, ATLM must be used on both sides of the lane.

Overtaking lanes and climbing lanes

Overtaking lanes and climbing lanes should not be started or ended on horizontal or vertical curves. The full development of the widened section should be completed at least 50 m before the tangent point of any curve and the widened section should be continued for 50 m past the tangent point on the exit to the curve.

Further consideration should be given to allowing existing formation widths to be used by reducing the shoulder width over the length of the overtaking lane or climbing lane to 0.5 m (sealed). Additional space may be obtained by reducing the width of the overtaking lane itself to as low as 3 m, retaining the acceptable width for the through lane. The traffic lane in the opposing direction should be the acceptable width for the conditions and may be modified if the adjacent shoulder is sealed for a minimum width of 1 m. The acceptable width of lane depends on the type of heavy vehicle using the road and the total traffic volume.

Table A.2.3 sets out possible carriageway widths for different road classes and traffic volumes for restricted situations using these principles. It has been developed on the basis of the acceptable widths suggested by the National Transport Commission *Network Classification Guidelines* but must be regarded as a design exception.

Table A.2.3(a) – Examples of carriageway widths (design exceptions) for passing lane sections (existing formations)

Road Class ⁽¹⁾	AADT	Carriageway (m) ^(3,4)
L2 ⁽²⁾	400 – 1000	0.5 + 3.0(6) + 3.1 3.1 + 1.0 = 10.7
	1000 – 4000	0.5 + 3.0(6) + 3.2 3.2 + 1.0 = 10.9
	>4000 ⁽⁵⁾	0.5 + 3.0 + 3.0 1.0 3.0 + 1.0 = 11.5
L3	400 – 1000	0.5 + 3.0(6) + 3.2 3.2 + 1.0 = 10.9
	1000 – 4000	0.5 + 3.0(6) + 3.2 3.3 + 1.0 = 11.0
	>4000 ⁽⁵⁾	0.5 + 3.0 + 3.0 1.0 3.0 + 1.0 = 11.5

Road Class ⁽¹⁾	AADT	Carriageway (m) ^(3,4)
L4	400 – 1000	0.5 + 3.0(6) + 3.2 3.3 + 1.0 = 11.0
	1000 – 4000 ⁽⁵⁾	0.5 + 3.0 + 3.0 1.0 3.0 + 1.0 = 11.5
	>4000 ⁽⁵⁾	0.5 + 3.0 + 3.0 1.0 3.0 + 1.5 = 12.0

Notes:

- Adapted from the National Transport Commission *PBS Scheme – Network Classification Guidelines*.
- Definitions of access levels are shown in Table A.2.3(b).
- Assumes all shoulders are fully sealed.
- Mitigation will be required to minimise run-off-road and head-on crashes.
- It is preferable to adopt 3 m lanes for the two opposing lanes and insert a 1 m painted median (|1.0|).
- As this lane accommodates trucks, it may be preferable to adopt the wider lane dimension and use the narrower lane for the other one. However, if this is a climbing lane where the speed of trucks will be low, the narrower lane would suffice.

Note that these dimensions do not consider the adjacent batter slope, the location of road edge guide posts, bicycle requirements or the need for safety barrier. Additional width will be required to accommodate road edge guide posts, bicycles and road safety barrier system.

Table A.2.3(b) – Definitions of access levels

Road Class	Scheme Vehicle Level	Vehicle Description
Level 1 access (L1)	1	From passenger cars to single articulated
Level 2 access (L2)	2	B-double
Level 3 access (L3)	3	Double road train (Type 1)
Level 4 access (L4)	4	Triple road train (Type 2)

(Refer National Transport Commission PBS Scheme).

Mitigation

Similar mitigation strategies to those for narrower lanes should be considered. Mitigation in a particular circumstance may include some or all of the following:

- batters of 1 on 4 or flatter adjacent to the shoulder (critical for 0.5 m shoulders)
- ATLM
- wider lane lines
- raised pavement markers
- rumble strips on the shoulder
- centreline rumble strips
- 1 m WCLT or painted median with ATLM, and/or
- hazard free roadside of 5 m or greater.

A.3 EDD for stopping sight distance

A.3.3 Vertical height parameters

Addition

At floodways in relatively flat terrain, it can be difficult to achieve stopping sight distance to the water surface height of 0.0 m in the floodway as defined in Table 5.1 of Austroads *Guide to Road Design – Part 3*. An EDD water surface height of 0.1 m should therefore be assessed for stopping sight distance based on the point at which the water depth on the front vehicle axle is 0.1 m.

A.3.7 Shoulder / traversable widths and manoeuvre times

Manoeuvre capability on batters is considered achievable when batters have a slope of 1 on 10 or flatter (desirable). The maximum slope allowed for this capability is 1 on 6.

A.3.8 EDD crest vertical curve size

A.3.8.1 Design exception crest vertical curve size

There is no equivalent Section A.3.8.1 in Austroads *Guide to Road Design – Part 3*.

New

In cases where the existing alignment does not meet these EDD values and a lower K value for the crest exists, retention of this crest is a design exception.

Such exceptions may be able to be justified in some circumstances. The amount of justification depends upon the relevant road design class as explained in Transport and Main Roads RPDM, Volume 3 Part 1.

Depending upon the project road design class and the magnitude of the design exception, alternatives will need to be developed and evaluated. Alternatives should include:

- adopt NDD requirements
- adopt EDD requirements, and
- retain existing geometry.

These will require sufficient design to allow reasonable estimates of cost to be developed and the impacts to be assessed. It is not sufficient to assume that retention of the existing is the only solution that needs to be evaluated.

Consideration should be given to realigning all substandard crest vertical curves to at least an EDD standard, especially when one or more of the following apply:

- minimal earthworks are required (e.g. < 1 m cut)
- the subgrade material is easy to remove and particularly if the material can be used elsewhere
- replacement of the existing pavement is required (or even rehabilitation), and/or
- there is an unsatisfactory combination with other geometric minima.

If a particular substandard crest vertical curve is being retained, consider what mitigating devices should incorporate e.g. fencing on roadside to keep animals (hazards) from being on the pavement. At least providing some manoeuvre widening for design exceptions should be considered.

Parameters to be examined include:

- perception reaction time – 1.5 secs may be appropriate, but may need some mitigation to increase alertness
- manoeuvre time – assume 2 secs for cars and 2.5 secs for trucks plus the perception reaction time
- height of object – it may be possible to make an assessment of the likelihood of particular obstructions being present (e.g. falling rocks, dead animals) but in all cases, the largest object that can be considered is that of a car stopped in the traffic lane ($h = 1.25$ m)
- carriageway width – there must be enough space to allow an approaching driver to manoeuvre around the stopped vehicle – shoulder widths of 2.5 m are required with batter slopes of 1 on 4 or flatter
- roadside hazard assessment, and
- providing a surface with increased friction resistance (maintenance measures will be required to ensure that this is retained in the long term).

Table A.3.8.1 shows how a situation may be analysed for manoeuvre capability for the appropriate 85th percentile speed. Other situations may also be analysed (e.g. buses [eye height 1.8 m]). This table shows the capability achieved for the worst case scenarios yielded by the above parameters, bearing in mind that more conservative values may be more appropriate for some parameters in a particular case (e.g. because of a coincident horizontal curve or the proximity of an intersection).

Consequently, Table A.3.8.1 identifies a limit below which is no useful sight distance capability exists for the 85th percentile speed and the lower limit for where supplementary manoeuvre width would be a useful mitigating treatment to help justify a design exception.

Table A.3.8.1 – Manoeuvre distances and K values – potential justification for design exceptions

V (km/h)	RT (sec)	Manoeuvre Time		Sight Distance (m)		K ¹	
		Car	Truck	Car	Truck	Car	Truck
80	1.5	2.0	2.5	78	89	6.5	6.6
90	1.5	2.0	2.5	88	100	8.25	8.4
100	1.5	2.0	2.5	97	111	10.02	10.3
110	1.5	2.0	2.5	107	122	15.85	12.46

Note 1: Car: Eye height = 1.1 m, Object height 1.25 m and Truck: Eye height = 2.4 m, Object height 0.8 m.

Retaining these types of crests will require appropriate mitigation measures, including speed control as described below. None of these would be acceptable if the site has a history of crashes.

Using an eye height of 1.1 m combined with an object height of 0.8 m for cars is preferred and would produce crest curves of K11.95 (95 m) and K16 (110 m) for these sight distances and these values should be adopted if possible.

If the existing road with posted speed equal to or greater than 90 km/h has K values of crest curves providing SSD less than 90 m, then they should be upgraded to at least EDD standard. If this is not possible, then a design exception exists, and it must be justified. In some circumstances, it may be

suitable to introduce a lower speed limit, provided it is credible to drivers. This may require speed environment measures to be implemented.

Combined geometric features

The presence of horizontal curves, property accesses, intersections and narrow carriageway singly or in any combination affects the ability to retain a sub-standard crest curve.

A horizontal curve of radius less than 600 m in conjunction with the sub-standard crest adds considerably to the driving task and may affect the ability of drivers to undertake suitable manoeuvring actions to avoid objects (including stopped vehicles) in their path. In general, a design exception crest curve should not be associated with a horizontal curve less than 600 m in radius. If the horizontal curve starts beyond the crest on the vertical curve, then the situation is not tolerable at all.

Property accesses and intersections located on or beyond the crest curve also make the situation intolerable when it is not possible to achieve at least EDD sight distance capability for the respective situation. The likelihood of crashes at such locations will be increased if they are retained. Over the long term, it can be expected that such locations will generate crashes even if the recent past has not produced such crashes. Note that there are situations where suitable sight distance can be achieved for an access or intersection located on top of a sub-standard crest. However, the suitability of the crest will still depend on the sight distance capability at other points on or beyond the crest.

A narrow carriageway allows no room for manoeuvre to occur if a driver is confronted with an obstacle in the road just over the crest. Without treatment of the width available, retention of the design exception will be difficult.

Austroads Guide to Road Design – Part 3, Appendix A addresses factors to be considered in the combination of horizontal and vertical alignment with width of carriageway when considering EDD.

Length of the design exception

Is this an isolated curve or one of a series of sub-standard curves? An isolated curve may not impose an unacceptable cost on the project if it is upgraded to at least EDD requirements. A series of such curves would be costly to improve and consideration of reduction of the posted speed limit would be reasonable. Mitigation measures over the whole length would be required to make the need for the reduced speed limit apparent to the drivers.

Duration of the design exception

If this is a long term proposal for the road, then the level of mitigation required will be substantial. Comparison of the costs of retention of the design exception plus mitigation with the cost of upgrading must be carried out to justify the decision.

Location with respect to other risk factors

Other features such as the location of narrow drainage structures, bridges and floodways close to the extremities of the crest will have an effect on the suitability of the retention of the exception. Such features require good visibility and if the crest prevents adequate visibility, it creates an unacceptable situation.

The location of roadside furniture and/or trees also has to be considered and action to address these features will be required.

Substantive safety at the site:

The types of crashes that may be associated with a sub-standard crest include:

- rear end crashes on the crest curve
- run-off-road crashes on or near the crest curve
- collisions at accesses or intersections on or near the crest curve, and
- head-on crashes on or near the crest curve.

If such types of crashes are present in the history and are linked to the reduced sight distance available, then retention of the exception cannot be justified.

Mitigation strategies

Where it is decided to adopt a crest curve design exception, the mitigation required is predicated on providing adequate space for manoeuvring around an obstruction and for recovery if the driver is forced to leave the carriageway. Where recovery cannot be provided, then action to reduce the severity of any crashes is required.

Strategy 1 - Speed control

Where circumstances permit, controlling the approach speed through the horizontal alignment producing lower operating speeds is desirable but this implies adjustments to the horizontal alignment. In projects where no changes are to be undertaken, this will not be an option. In these circumstances, consideration should be given to reducing the posted speed (only useful if it appears credible to the driver).

In some circumstances, the approach speed may be influenced by a narrower cross section, but this may conflict with other potential mitigation strategies. Some success has been found with rumble strips on the approach to construction zones (refer to Hildebrand et al, 2005) and this could also be applied on the approach to sharp crests in conjunction with 'Crest Reduce Speed' signs (sign TC 1308B – W5-11B). This combination of rumble strips and signs will need to be tested to determine its suitability.

Strategy 2 – Manoeuvre space

This requires provision of additional width of carriageway over the length of the restricted sight distance with a desirable width of 12 m (2 x 3.5 m lanes plus 2 x 2.5 m shoulders). The minimum width of shoulder to be adopted is 2 m. This is based on the normal centre-line marking. A better situation will be achieved by using the full 12 m width as follows:

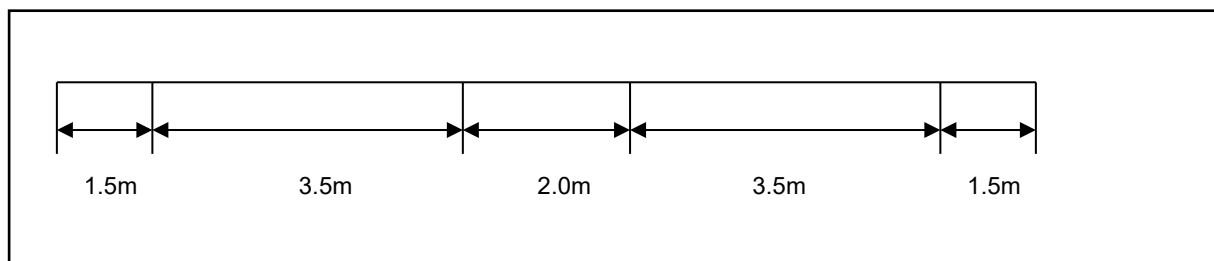

Appropriate curvature of the lanes would be required to achieve the move to the section with a median. The median will need to be painted in accordance with the Transport and Main Roads Queensland MUTCD and in some circumstances a wire rope barrier could be installed.

If these dimensions cannot be achieved, then additional manoeuvre space outside the shoulders will be required. That is, the batters will need to be 1 on 4 or flatter (preferably 1 on 6) with as much roadside free from hazards as possible, preferably at least 5 m.

Note also that additional width can be achieved by adopting underground drainage with Type 28 channel through the cutting instead of table drains.

Strategy 3 – Signage

The 'CREST (W5-11)' sign (refer Transport and Main Roads Queensland MUTCD) should be used in these circumstances even though its effectiveness is questionable. Better performance may be obtained by using the 'Reduce Speed' sign in conjunction with it, together with rumble strips (see above) although this is yet to be proven.

Audio Tactile Line Marking should be used for edge lines.

A.4 EDD for horizontal curves with adverse superelevation

Addition

In the 1st sentence of the 2nd paragraph, it should read 'desirable maximum of side friction factor', rather than, 'absolute maximum of side friction factor'.

A.5 Offset crown lines

There is no equivalent Section A.5 in Austroads *Guide to Road Design – Part 3*.

New

A.5.1 Crossfall configuration and crown lines on side slopes

Where there are significant differences in levels between opposite sides of an existing road, the conventional crown line location and crossfalls can result in difficulties in maintaining access and costly adjustments to properties or public utilities.

In these circumstances a one-way crossfall is acceptable. The one-way crossfall should not exceed 4% (3% is preferred) and for aesthetic reasons the crossfall should extend full width between gutters (from lip to lip, including the median).

However, where drainage into the high side gutter is considerable, the crossfall of the adjacent kerbside lane can be reversed to a maximum of 4% to increase the gutter capacity. The resulting break in the crossfall is called an offset crown and is usually located at the offside edge of the kerbside lane. The development of the offset crown requires careful design to avoid having the crown cross vehicle paths. Figure A.5.2 shows the required method of developing an offset crown.

Whilst a one-way crossfall design is often satisfactory in sloping country, there are areas with steep slopes where this method will not meet requirements. Under these conditions it may become necessary to consider other solutions, such as providing parallel service roads or split-level carriageways.

A.5.2 Widening two-lane roads – offset crown

For crowned two-lane, two-way road, symmetrical widening on both sides of the pavement retains the crown at the centre of the pavement.

Widening on one side only may be considered when the following site-specific issues make it difficult to widen on both sides:

- Services, property boundaries or a longitudinal watercourse located close to the carriageway on one side.
- Preference to lengthen culverts and headwalls on one side only.
- Desire to align the road to fit adjacent intersections. This may also apply when new turning lanes are planned.
- When adjacent to horizontal curves, designers may widen the tangent on one side when improvements are made to the curve that is improving curve radii or installing transitions.

When widening is undertaken on one side of the pavement, it is preferred that the crown is shifted to remain in the centre of the new carriageway. This can be achieved by:

- Reforming all pavement layers to reinstate the crown.
- Reinstall the crown in the correct location using overlay only. This varying overlay thickness across the pavement formation.

Where the crown cannot be located in the centre of the carriageway, an offset crown to one side of the new centreline not more than 1.5 m from the new centreline is acceptable. Locating the offset crown line closer to the edge line creates a disturbing effect to the driver and is unacceptable.

Motorcyclists

If single sided widening is contemplated with an offset crown line, the crown line location must be coordinated with the position of service and access chamber covers, particularly on curves, to ensure a motorcyclist's path avoiding the crown does not direct them over service and access chamber covers.

Figure A.5.2 – Development of offset crown

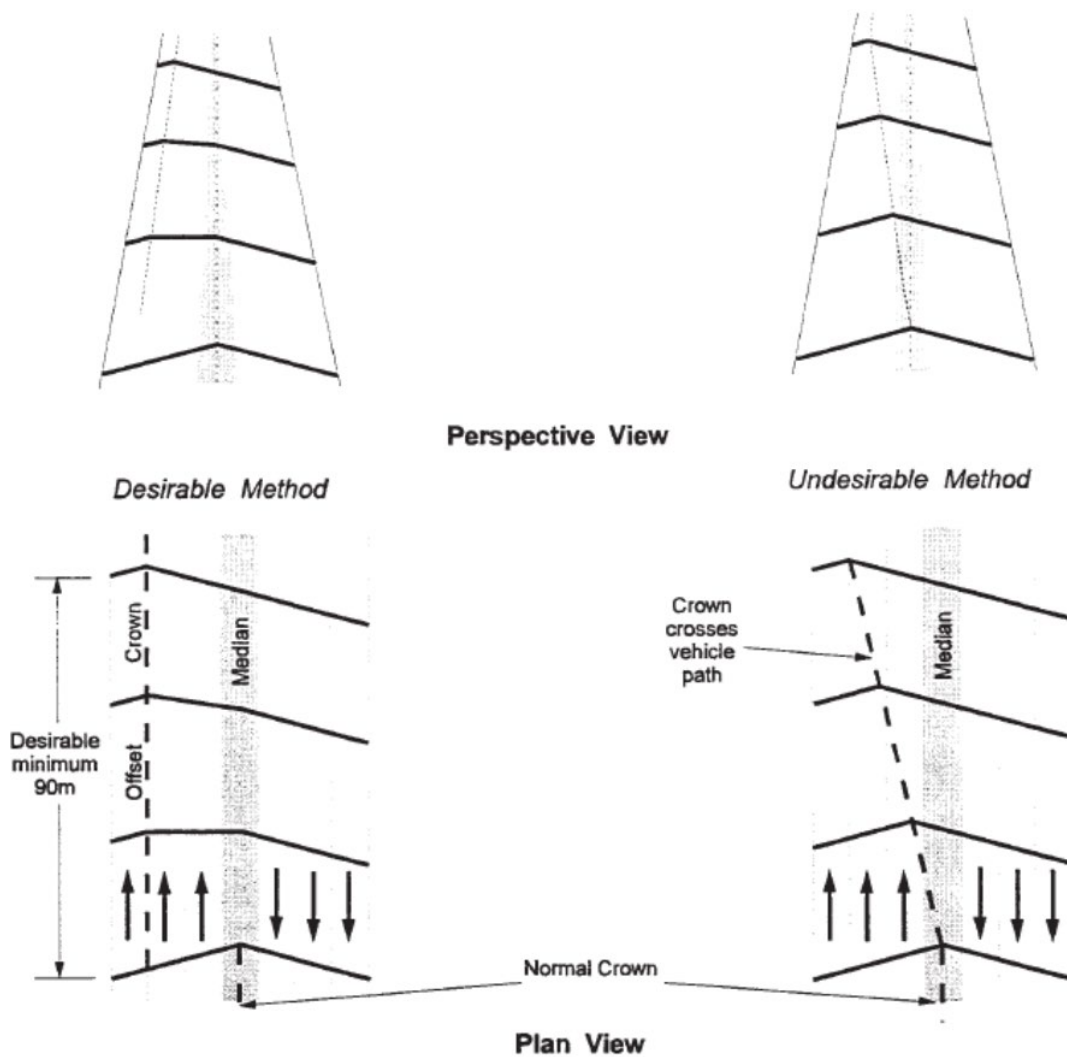

A.6 Development of superelevation to avoid drainage problems

There is no equivalent Section A.6 in Austroads *Guide to Road Design – Part 3*.

New

- Individual lane rotations are an EDD design treatment that can reduce excess water film depths on motorways:
 - The design process should first consider rotating two lanes at a time and then proceed to individual lane rotations if further water film reductions are required.
 - The individual lane rotations should be positioned so they suit the final position of lane markings. This is relevant when it is anticipated that the road will be re-line marked with an additional lane in the future.
 - Some overlap of rotations is permitted, provided that water from one rotation is not combining with water flow from adjacent rotations.
 - It is necessary to ensure that there is sufficient tangent length between reverse curves to accommodate multiple rotations.

- Multiple lane rotations usually avoid relative grade appearance issues between the carriageway edges.
- Diagonal or wandering crown – the use of a diagonal crown normally eliminates excess water film depths as the pavement does not rotate through a flat spot. A diagonal crown has been used before in Queensland on the Bruce Highway Southbound over the Caboolture River and a number of locations on the Port of Brisbane Motorway. While it is an uncommon method, the use of a diagonal crown is considered EDD:
 - The design of a diagonal crown must ensure rotation rates applied to car and trucks are not exceeded. This normally means that the diagonal crown is lengthy. Designers may consider flattening the crossfall to 2% for a short distance either side of the crown line in heavy duty pavements only.
 - It is recommended that designers consult with construction personnel as the construction method is different from normal.

Appendix G – Guidance for Wide Centre Line Treatments (WCLT)

Difference

The entire Appendix G in Austroads *Guide to Road Design – Part 3* is replaced with the following.

G.1 Purpose

This appendix provides guidance for the use of Wide Centre Line Treatment (WCLT) together with Audio Tactile Line Marking (ATLM) (where required) to establish a uniform statewide application for this treatment. A WCLT is the widening of the centreline markings to provide increased lateral separation between opposing directions of travel. This increased separation improves safety by reducing head-on crash risk.

G.2 Background and objective

A WCLT is a 'widened' dividing line, including audio tactile line marking where applicable. This treatment provides additional separation between vehicles travelling in opposite directions to improve safety, in particular reducing the potential for head on crashes.

The use of the WCLT together with ATLM, as shown in Figure G.2, has demonstrated a substantial reduction in the number of crashes on higher volume two-lane rural roads. In particular, the use of a WCLT on 10 m and 10.5 m wide sealed carriageways in high speed areas is considered to be a viable alternative that reduces the crash potential for a wide range of traffic volumes. In these circumstances, it may be appropriate on existing roads to sacrifice some lane and shoulder width to achieve a WCLT.

The reduction in potential cross-centreline crashes must be weighed against the potential for increased run off road and cyclist crashes if compromises have been made to lane and shoulder widths.

Figure G.2 – WCLT with ATLM



It is understood that painted islands used as medians have different road rules associated with them compared to a WCLT. Furthermore, installation (now or in the future) of a barrier system in the middle of a WCLT changes the treatment from WCL to median.

G.3 Application

The implementation of WCLT standards should consider all the benefits and costs of the particular application for a network or link in the context of the above objectives. The timing of the implementation at specific locations should also consider the remaining life of the existing asset and to coordinate any enhancement (such as widening seals) with rehabilitation or programmed maintenance activities thereby achieving improved delivery efficiency.

Therefore, any decision to implement the WCLT should be made on a network or link basis and should consider maximising the rollout of WCLT and delivery cost effectiveness of enhancement work at specific locations.

Where road widening or shifting the edge line out is required to implement WCLT, consideration should be made to the impacts to existing roadside amenities such as parking and bus bays, designated cycle routes, turning paths to accesses and intersections, clearance to street light poles, offsets to roadside barriers and sign posts, hazards within the new clear zones, working widths to structures and impacts to drainage (flood afflux, structure ends, aquaplaning).

Furthermore, existing pavement configuration should be checked as treatments move the wheel paths (and loadings) of vehicles wider on the carriageway. This also applies to certain bridge structures (in particular those with cantilevered piers).

G.4 Dimensions and design of WCLT

G.4.1 Minimum length of WCLT

The minimum length that a WCLT should be installed over is 2 km (inclusive of intersections and other structure treatments).

Cross section of WCLT

The dimensions related to WCLT and application of ATLMs is detailed in Table G.4.1(a) below.

Table G.4.1(a) – WCLT dimensions and ATLM application

Posted Speed	WCLT ⁽¹⁾	ATLM ⁽²⁾
90 km/h and greater	1 m	Yes
70 – 80 km/h	0.8 m	Yes ⁽³⁾
60 km/h	0.6 m	No ⁽³⁾

Notes:

1. WCLT is width between the centres of the lines at either side of the treatment.
2. This refers to the provision of ATLM at the centreline, not the edge line. Provision of ATLM at the edge line is to be based on a separate assessment of the risk for run off road crashes.
3. This represents the department's default position but may be reconsidered based on an assessment of site-specific factors, such as relevant noise receptors.

It is important to note that the WCLT widths above are based on providing similar travel times across the treatment. Other factors such as driver behaviour and driver's perception to determine when a vehicle will not return to the correct side of the road has not been considered and further research is required.

Recommended dimensions for road cross sections incorporating a WCLT on a straight section of road with posted speeds of up to 110 km/h are detailed in Table G.4.1(b) for NDD and Table G.4.1(c) for EDD.

On horizontal curves, the road cross-section should also include the need for curve widening to accommodate large vehicles.

The cross sections in Tables G.4.1(b) and G.4.1(c) represent the minimum WCLT cross-section based on general road use only. Where the sealed shoulder is used for other purposes such as for cycling (for example on the Principal Cycle Network (PCN) or as part of other cycle networks), for parking and so on, the shoulder widths in Tables G.4.1(b) and G.4.1(c) should be extended to accommodate these requirements. The appropriate sealed shoulder widths for these requirements are detailed in Section 4. Particularly on the PCN, the department's policy requires explicit provision for cycling on PCN routes and that this will affect the applicable minimum seal widths.

Table G.4.1(b) – Normal design domain cross section for a WCLT – two-lane, two-way roads

Design AADT	Vehicle routes	Sealed Shoulder ⁽²⁾⁽³⁾⁽⁴⁾ (m)	Lane Width ⁽¹⁾ (m)	WCLT (m)	Total Seal Width (m) ⁽⁶⁾	
2000 - 4000	All vehicles up to B double	1.75	3.25	Refer Table G.4.1(a) for width	11.0	
	Type 1 Road Train	1.50	3.50			
	Type 2 Road Train	1.25	3.75			
> 4000	All vehicles up to B double	1.75	3.25		Refer Table G.4.1(a) for width	11.0 ⁽⁵⁾
	Type 1 Road Train	1.50	3.50			
	Type 2 Road Train	1.25	3.75			
	All vehicles up to B double	2.00	3.25			11.5
	Type 1 Road Train	1.75	3.50			
	Type 2 Road Train	1.5	3.75			

Refer Notes below Table G.4.1(c).

Table G.4.1(c) – Extended design domain cross section for a WCLT – two-lane, two-way roads

Design AADT	Vehicle routes	Sealed Shoulder ⁽²⁾⁽³⁾⁽⁴⁾ (m)	Lane Width ⁽¹⁾ (m)	WCLT (m)	Total Seal Width (m) ⁽⁶⁾	
2000 - 4000	All vehicles up to B double	1.25	3.25	Refer Table G.4.1(a) for width	10.0	
	Type 1 Road Train	1.00	3.50			
	Type 2 Road Train	1.00	3.75			
> 4000	All vehicles up to B-double	1.25	3.25		Refer Table G.4.1(a) for width	10.0 ⁽⁵⁾
	Type 1 Road Train	1.00	3.50			
	Type 2 Road Train	1.00	3.75			
	All vehicles up to B-double	1.50	3.25			10.5
	Type 1 Road Train	1.25	3.50			
	Type 2 Road Train	1.25	3.75			

Notes to Tables G.4.1(b) and G.4.1(c):

1. In situations with more than one lane in a single direction, the lane width is the same for all lanes.
2. In situations with an auxiliary lane, a shoulder width of 1 m is often satisfactory. This width should be increased in areas of restricted visibility (e.g. around curves or where road safety barrier systems are present) and in the merge area at the end of the lane.
3. In many instances these shoulder widths are not sufficient to meet the specific requirements for cycling or other uses of the sealed shoulder. Where the route is part of a cycle network, additional sealed shoulder width may need to be included, see Section 4.3.2.
4. The sealed shoulder width is the width to be provided where road safety barriers are not present. Where a road safety barrier is present and is less than 1 km in length, this width represents the clear width from the centre of the edge line, to the front face of the barrier. Where a road safety barrier is present and is greater than 1 km in length (continuous barrier, no break of 100 m or more, or a pull-off bay provided), this width is insufficient and needs to be increased to 3 m minimum. In both cases, the sealed shoulder width in these circumstances does not include any part of the shoulder / verge located behind the face of the barrier (supporting the barrier system).
5. These cross sections should only be used on roads in cuttings, or low embankments or where the batter slope is not steeper than 1 on 4. If roadside barriers are used, additional verge width should be applied to accommodate the barrier.
6. Total seal width is based on 1 m WCLT. Total width will reduce if speed zone is less than 90 km/h and utilises a reduced width WCLT (Table G.4.1(a)).
7. A 12.5 m wide cross section provides for a 2 m wide painted median with optional wide rope barrier.

G.4.2 Retrofitting WCLT to seals wider than specified for NDD or EDD

The dimensions presented in Tables G.4.1(b) and G.4.1(c) are the minimum requirements. Where the existing seal width is in excess of the required width, the additional width should be used to widen the sealed shoulders above the minimum listed. For example, an EDD situation (Table G.4.1(c)) on a B-double route, AADT of less than 4000, posted speed of 100 km/h and an existing seal width of 10.5 m, the additional width (0.5 m) over the EDD requirements should be utilised to widen the shoulders to 1.5 m wide.

Where a seal width greater than NDD requirements is available (or possible due to proposed widening works), the lane width for B-double routes should be increased to 3.5 m.

G.5 WCLT at intersections

Figures G.5(a) [CHR type] and G.5(b) [BAR / BAL type] provide examples of how a WCLT is applied at intersections.

For CHR / CHR(s) intersections

Where double barrier line is to be applied in conjunction with chevron painted island (right turn intersections), Figure G.5(c) shows the transition between double barrier line / painted island / WCLT.

For BAR intersections

With reference to Austroads *Guide to Road Design - Part 4A: Basic right (BAR) turn treatment on a two-lane rural road*, dimension 'C' should be measured from the nearest side of the WCLT for NDD and EDD. This is to allow following vehicles to manoeuvre left to pass the vehicle turning right from within the through traffic lane. It cannot be assumed that turning vehicles will use the WCLT 'space' (even if permitted), while waiting to turn right.

For BAL intersections

With reference to Austroads *Part 4A: Rural basic left-turn treatment (BAL)*, dimension 'C' should be measured from the nearest side of the WCLT for NDD and EDD. This is to allow following vehicles to remain in the through lane and pass the vehicle turning left without entering onto the WCLT.

Figure G.5(a) – WCLT at channelised right turn intersections

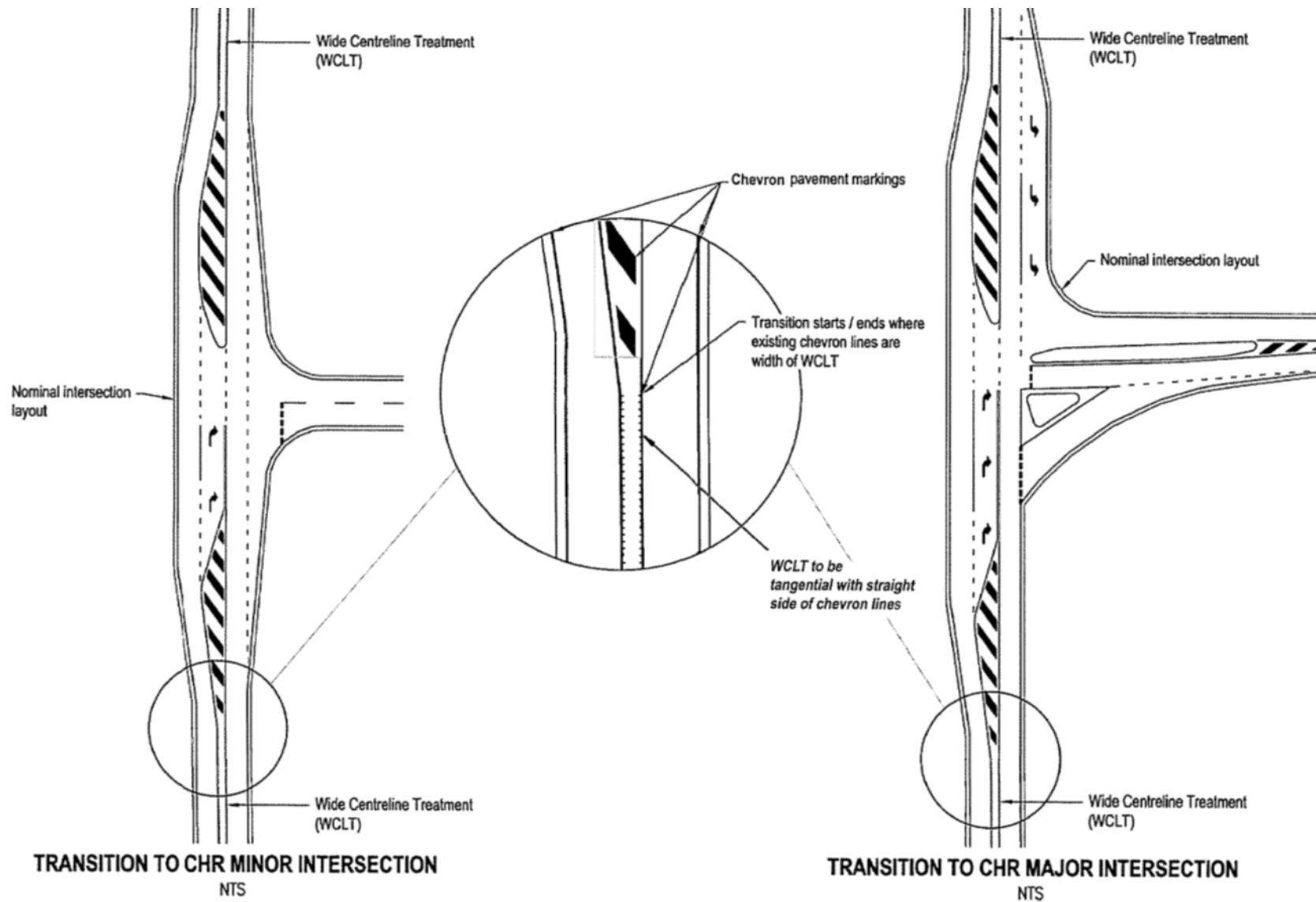

Figure G.5(b) – WCLT at basic right turn intersections and private property entrances

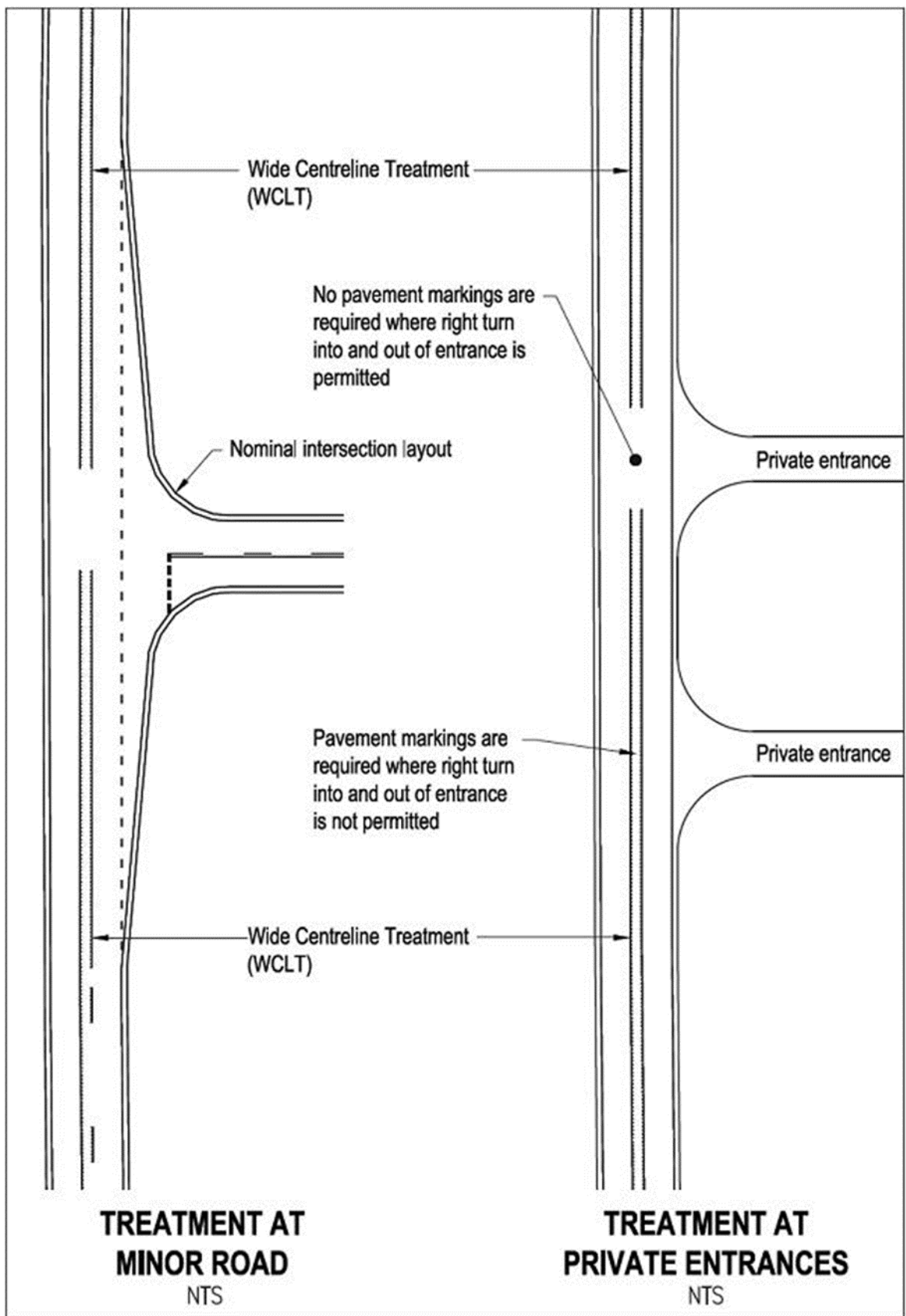
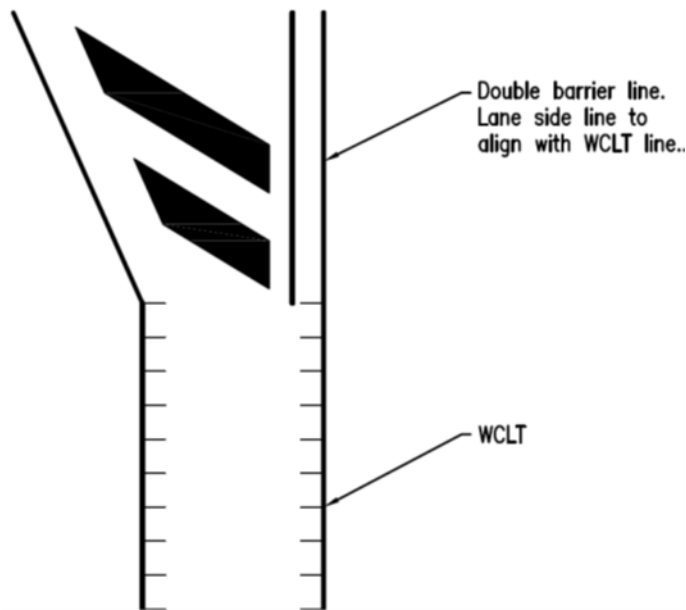

Figure G.5(c) – WCLT to double barrier line transition at right turn intersections

G.6 WCLT over narrow structures

G.6.1 Single narrow structure

The presence of culvert headwalls or narrow structures (bridges or floodways) are to be considered when installing a WCLT due to the proximity roadside hazards can have increasing the severity of crashes.

In these circumstances, the minimum shoulder and lane widths in Tables G.4.1(b) or G.4.1(c) apply and should be retained through the narrow structure. Therefore, to accommodate reduced formation widths, the WCLT is to be reduced as shown in Figure G.6.2(a) until either the existing formation width or the standard barrier line configuration is achieved, whichever occurs first.

The reduction of the width of the wide centreline is achieved by tapering the centre dividing lines at 0.6 m/s lateral shift either side of the localised narrowing, as detailed in Figure G.6.2(a). The tapering of the wide centreline must be complete before the localised narrowing (for example guardrail or culvert headwalls or bridge rails) starts. This approach minimises the lateral shift of vehicles while travelling over the structure.

G.6.2 Successive narrow structures

Where there are successive localised narrowings (e.g. two or more bridges / culverts) only a short distance apart, the WCLT treatment should not be marked over the short section to avoid unusual visualisation and excessive lateral shifting of vehicles. The WCLT treatment should only be marked between successive narrowings when a minimum length of 200 m of full width WCLT can be achieved as shown in Figure G.6.2(b).

For example, for a 100 km/h posted speed this therefore requires that the localised narrowings are at least 320 m apart to allow for the 30 m minimum straight length either side of the narrowing and the 30 m transition length.

Figure G.6.2(a) – WCLT transition at a narrow structure (Not to scale)

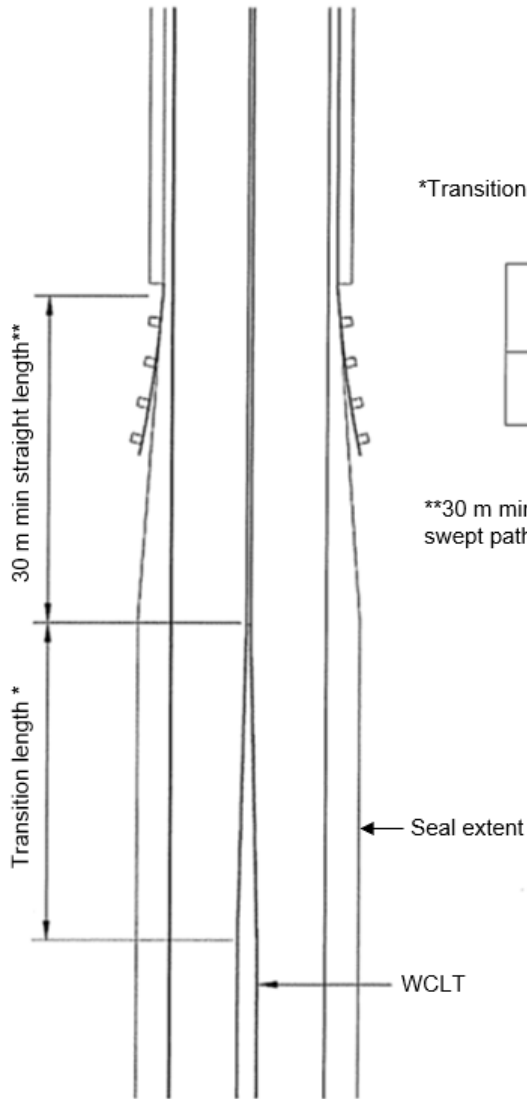

*Transition lengths calculated using 0.6 m/s lateral shift and value rounded.

WCLT Transition Lengths (m)

Width of WCLT (m)	Posted Speed (km/h)					
	60	70	80	90	100	110
1.00	20	20	25	25	30	30

**30 m min straight length required for vehicle tracking. Design vehicle swept path should be checked.

Figure G.6.2(b) – WCLT transition at successive narrow structures (Not to scale)

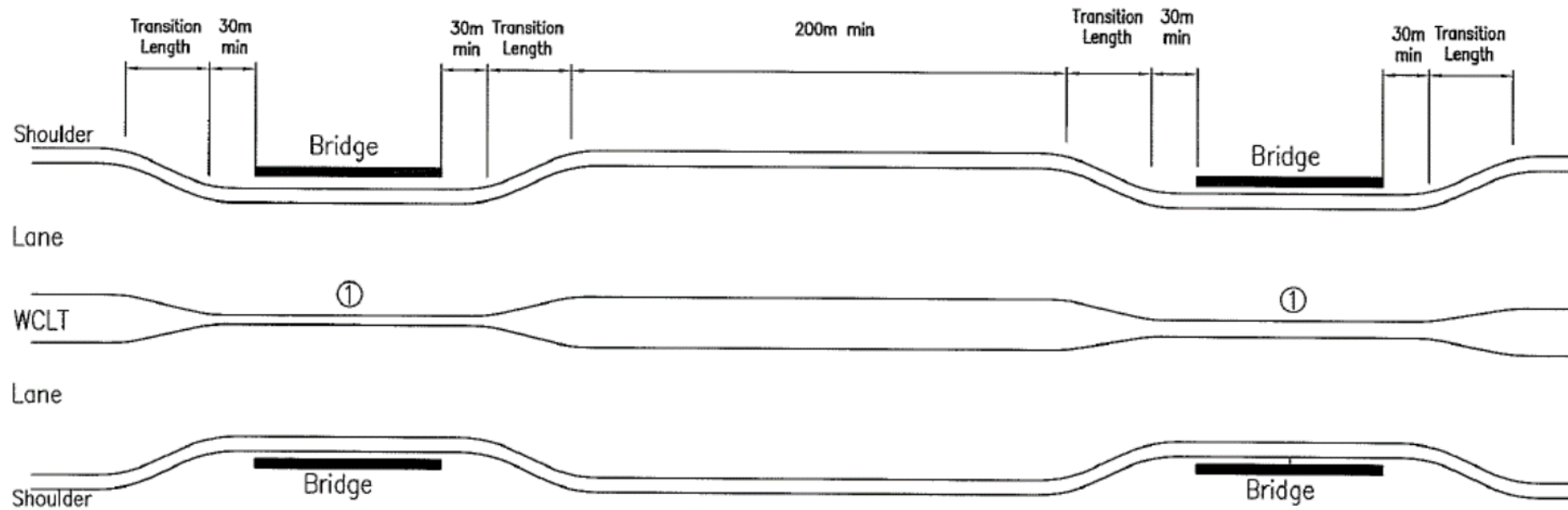

Notes:

1. The width of the WCLT over the narrow bridge structure is the residual width available while maintaining the lane and shoulder widths. These widths may vary at successive structures dependent on the residual width available.

G.7 WCLT at overtaking lanes / climbing lanes

At locations where an overtaking or climbing lane is provided in one direction, a WCLT may be installed for sections of road shorter in length than the 2 km minimum normally required (refer Section G.4). Although it is preferred to extend the WCLT to a minimum 2 km length, it is acknowledged that in these cases the additional width provides significant benefit due to the operational and safety performance of these designs.

The WCLT is transitioned at either end of the overtaking lanes or climbing lanes, as illustrated in Figure G.7.

Figure G.7 – WCLT treatment at overtaking / climbing lanes (Not to scale)

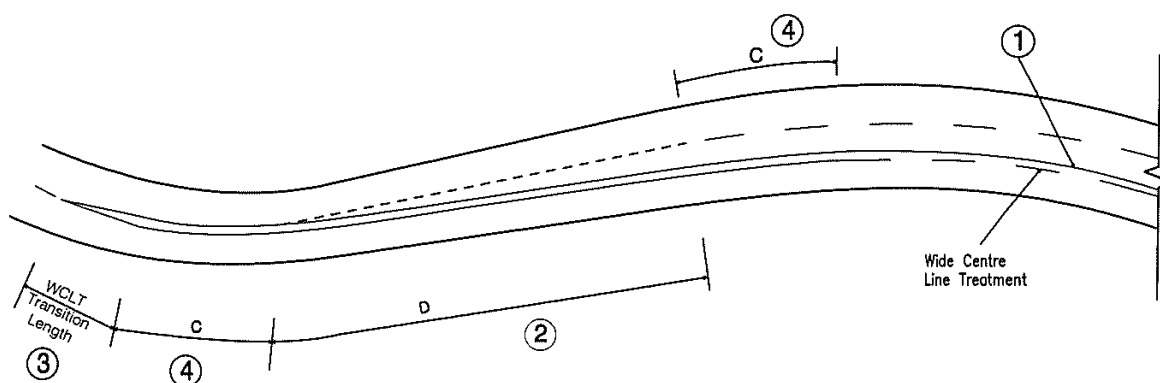

a) Transition of WCLT at start of overtaking / climbing lanes.

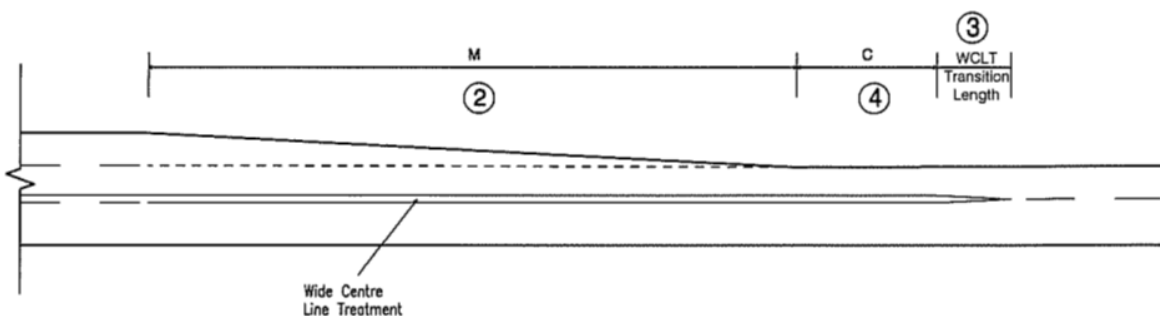

b) Transition of WCLT at end of overtaking / climbing lanes.

Notes:

1. A double barrier line is required if the warrants described in Transport and Main Roads MUTCD Part 2 are met.
2. 'M' and 'D' are the required merge and diverge distances calculated in accordance with Section 9 of Austroads *Guide to Road Design - Part 3*.
3. The WCLT Transition lengths are as detailed in Figure G.6.2(a).
4. Dimension C is as follows (sourced from Transport and Main Roads MUTCD Part 2).

V85 km/h	C m
< 75	36
75 - 90	60
> 90	96

At either end of the overtaking lane the WCLT must extend dimension 'C' past the diverge / merge as detailed in Figure G.7 as adapted from MUTCD Part 2, Figure 4.21 - *Overtaking lanes on two-lane rural roads*. The WCLT transition is not included in this dimension.

At overtaking lanes or climbing lanes, the lane widths in the direction with the overtaking or climbing lane are all to be the same and should be in accordance with the NDD requirements in Table G.4.1(b) or the EDD requirements in Table G.4.1(c). These widths are required due to the potential for design vehicles to be travelling in either lane in the section with the overtaking or climbing lane.

Where the road is a four-lane section with two-lanes in each direction, a WCLT is not appropriate and either a barrier or a painted median treatment should be applied.

G.8 WCLT signage and ATLM requirements

G.8.1 Signs

For WCLT sign layouts and specific sign details refer to Transport and Main Roads *Traffic Control Sign drawings TC1979_1 to TC1979_9*.

A maximum of four signs (one for each line marking change when drivers first encounter the change) should be erected along a link between significant towns or highway junctions. They should generally not be spaced any closer than 50 – 75 km apart (in many instances they will be greater than 100 km apart).

Audio Tactile Line Markings (ATLM)

The positioning and layout of ATLM at WCLT are detailed in Transport and Main Roads *Traffic Control Sign drawings TC1978_1 to TC1978_3*. It is important to note that the ATLMs are located offset, not on top of, the associated line marking.

During the installation of a WCLT, it is acknowledged that ATLMs (where applicable) will be marked at a different time to the marking of the WCLT due to the application of different equipment for each marking type. In some cases, if a reseal of the pavement is scheduled shortly after the installation of the WCLT, the installation of the ATLMs may be deferred until after the next reseal as economically viable.

G.9 Design exceptions (departures)

Where seal widths less than the widths in Table G.4.1(c) (EDD) are considered for a WCLT, these are considered a design exception. If a design exception for seal width only is being considered, the following are recommended:

- the condition of the unsealed shoulder must be taken into consideration and there should be no edge drop between the sealed and unsealed portion of the shoulder, and
- the verge / balance area will need to be regularly maintained due to vehicles travelling closer to the verge.

In some circumstances WCLT widths less than 1 m and as low as 0.5 m have been adopted as a design exception or departures where constraints have been significant. However, safety outcomes are likely to be less than what has been possible using the NDD width.

If a staged approach to the centre treatment is proposed and the treatment will ultimately incorporate a road safety barrier, consideration could be given to providing a WCLT wider than 1 m (up to 2.2 m) to allow for future barrier installation without the need to construct additional widening. This situation is considered a design exception or departure. In such cases the solution proposed should be designed

appropriately allowing for future implementation of the safety barrier. Care should be taken if a centre treatment width greater than 1.5 m is proposed as there is potential for motorists to confuse the treatment for a passing lane.

Temporary treatments

A temporary WCLT implementation for a period of time, prior to associated asset enhancement works, would be considered as a design exception. In these cases, if formations are adequate and the seal width does not meet EDD requirements, designs have been implemented as a temporary solution with a WCLT with shoulders narrower than specified. This implementation has been justified for a short-term basis until later upgrade to full NDD / EDD width as part of asset rehabilitation or programmed maintenance works.

The points for consideration to support such a decision are:

- the timing for when any widening is undertaken to reduce overall network costs
- funding decisions to support maximising the length of treatment
- the early implementation of the WCLT may offer benefits in some situations, and
- the condition of the unsealed shoulder and the *Road Maintenance Performance Contract* (RMPC) maintenance requirements.

There may be benefits in rapid implementation of WCLT, with widening completed at the most cost-effective time. This design exception must be designed, approved and signed off in accordance with the appropriate processes.

G.10 Widening to incorporate a WCLT

The process to be applied in widening existing seal widths less than specified in Table G.4.1(c):

- i. where sufficient formation is available, the shoulders should be widened to at least the extent of the EDD width (minimum) or preferably to NDD, and
- ii. where insufficient formation is available, the formation will require widening to allow the seal to the full NDD width.

If reconstruction of the road requires formation widening, the extent of the widening should be made sufficient to ensure at least one future overlay can be applied maintaining the appropriate cross section dimensions, unless there are strong economic reasons not to do so.

Commentary 3

Addition

On urban roads, the operating speed is found during low flow conditions which will typically occur during the early hours of the morning. While the items listed in Commentary 3 of Austroads *Guide to Road Design – Part 3* impact the operating speed, they are unlikely to be prevalent during low flow conditions and hence will have little impact (if any) on the operating speed at these times. This includes items such as vulnerable road users and parking manoeuvres. Other aspects, such as traffic signal progression, may take the other items into account.

