

# Materials Testing Manual

## Edition 6, Amendment 1

May 2024



## Copyright

© The State of Queensland (Department of Transport and Main Roads) 2024.

## Licence



This work is licensed by the State of Queensland (Department of Transport and Main Roads) under a Creative Commons Attribution (CC BY) 4.0 International licence.

## CC BY licence summary statement

In essence, you are free to copy, communicate and adapt this work, as long as you attribute the work to the State of Queensland (Department of Transport and Main Roads). To view a copy of this licence, visit: <https://creativecommons.org/licenses/by/4.0/>

## Translating and interpreting assistance



The Queensland Government is committed to providing accessible services to Queenslanders from all cultural and linguistic backgrounds. If you have difficulty understanding this publication and need a translator, please call the Translating and Interpreting Service (TIS National) on 13 14 50 and ask them to telephone the Queensland Department of Transport and Main Roads on 13 74 68.

## Disclaimer

While every care has been taken in preparing this publication, the State of Queensland accepts no responsibility for decisions or actions taken as a result of any data, information, statement or advice, expressed or implied, contained within. To the best of our knowledge, the content was correct at the time of publishing.

## Feedback

Please send your feedback regarding this document to: [tmr.techdocs@tmr.qld.gov.au](mailto:tmr.techdocs@tmr.qld.gov.au)

## List of contents: 6<sup>th</sup> Edition, Amendment 1

<b>Part 1</b>	<b>Introduction</b>	
	Introduction	May 2024
<b>Part 2</b>	<b>Application</b>	
	Application	May 2024
<b>Part 3</b>	<b>General</b>	
Q020	Calculation of characteristic value of a lot	January 2024
<b>Part 4</b>	<b>Sampling</b>	
Q050	Random selection of sampling or test locations	January 2024
Q060	Representative sampling of soils, crushed rock and aggregates	January 2024
Q061	Spot sampling of soils, crushed rock and aggregates	January 2024
Q070	Dry coring of bound materials	January 2024
Q080	Sampling of bituminous binder	January 2024
<b>Part 5</b>	<b>Soils, Crushed Rock and Stabilised Materials</b>	
Q101	Preparation of disturbed samples	January 2024
Q101A	Sample combination and splitting	January 2024
Q101B	Representative sample reduction	January 2024
Q101C	Fractionation	January 2024
Q101D	Break-up, cleaning and crushing	January 2024
Q101E	Pre-treatment	January 2024
Q101F	Crushing	January 2024
Q101G	Sample blending	January 2024
Q101H	Sample screening / sieving	January 2024
Q101J	Sample washing	January 2024
Q103A	Particle size distribution of soil – wet sieving	January 2024
Q104A	Liquid limit of soil	January 2024
Q104D	Liquid limit of soil – one point	January 2024
Q105	Plastic limit and plasticity index of soil	January 2024
Q106	Linear shrinkage of soil	January 2024
Q113A	California Bearing Ratio of soil – standard	January 2024
Q113B	California Bearing Ratio of soil – modified	January 2024
Q113C	California Bearing Ratio of soil at nominated levels of dry density and moisture content	May 2024
Q114B	Insitu California Bearing Ratio – dynamic cone penetrometer	January 2024
Q115	Unconfined compressive strength of stabilised materials	January 2024
Q118	Bitumen content of stabilised material	January 2024
Q120B	Organic content of soil – loss on ignition	January 2024

<b>Part 5 (cont)</b>	<b>Soils, Crushed Rock and Stabilised Materials</b>	
Q125D	Capillary rise of stabilised material	January 2024
Q133	Lime demand of soil	January 2024
Q134	Stabilising agent content – heat of neutralisation	January 2024
Q135A	Addition of stabilising agents	January 2024
Q135B	Curing moulded specimens of stabilised material	January 2024
Q136A	Working time of stabilised material	January 2024
Q136B	Working time of foamed bitumen stabilised material	January 2024
Q137	Permanent deformation and resilient modulus of unbound material	January 2024
Q138A	Preparation and compaction of laboratory mixed foamed bitumen stabilised material	May 2024
Q138B	Preparation and compaction of field mixed foamed bitumen stabilised material	January 2024
Q139	Resilient modulus of stabilised material – indirect tensile method	January 2024
Q140A	Relative compaction of soils and crushed rock	January 2024
Q141A	Compacted density of soils – nuclear gauge	January 2024
Q141B	Compacted density of soils and crushed rock – sand replacement	January 2024
Q142A	Dry density-moisture relationship of soils and crushed rock – standard	May 2024
Q142B	Dry density-moisture relationship of soils and crushed rock – modified	May 2024
Q143	Treatment of oversize material	January 2024
Q144A	Assignment of maximum dry density and optimum moisture content for soils and crushed rock	January 2024
Q145A	Laboratory compaction to nominated levels of dry density and moisture content	May 2024
Q146	Degree of saturation of soils and crushed rock	January 2024
Q147B	Compacted density of stabilised material – vacuum saturation	January 2024
Q148	Manufacture of laboratory slab specimens – segmental wheel compactor	January 2024
Q149	Deformation of granular material – wheel tracker	January 2024
Q250	Moisture ratio of soils and crushed rock	May 2024
Q251A	Preparation and compaction of laboratory mixed stabilised materials	January 2024
Q251B	Preparation and compaction of field mixed stabilised materials	January 2024
Q251C	Preparation and compaction of soil	January 2024

<b>Part 5 (cont)</b>	<b>Soils, Crushed Rock and Stabilised Materials</b>	
Q252	Plastic properties of a soil	January 2024
Q253	Particle size and shape properties of a soil	May 2024
Q254A	Addition of foamed bitumen	January 2024
Q254B	Curing moulded specimens of foamed bitumen stabilised material	January 2024
Q255	Addition of water	January 2024
Q257	Modified compression test for pavement materials – Texas triaxial	January 2024
Q258A	Dynamic modulus of deformation – light falling weight device – accelerometer type	January 2024
Q258B	Surface modulus – Light weight deflectometer (LWD) – load cell type	January 2024
<b>Part 6</b>	<b>Geotechnical, Environmental, Rock</b>	
Q160	Water repellency of soil (hydrophobicity)	January 2024
Q161	Soil aggregate test – slaking	January 2024
Q162	Soil aggregate test – clouding	January 2024
Q163	Soil wettability	January 2024
Q164	Soil hydraulic conductivity (permeability)	January 2024
Q165	Soil bulk density	January 2024
Q166	Soil field texture	January 2024
Q167	Soil particle size analysis (PSA)	January 2024
Q168	Emerson class of a soil (modified)	January 2024
Q181C	Effective angle of internal friction at constant volume conditions for granular materials – coarse grained	January 2024
Q188	Petrographic assessment of aggregates	January 2024
Q191	Inspection of installed pavement drains – bore scope	January 2024
Q192	Robustness of geotextiles	January 2024
<b>Part 7</b>	<b>Aggregates</b>	
Q201	Flakiness index of aggregate	January 2024
Q203	Polished aggregate friction value	January 2024
Q208B	Degradation factor of coarse aggregate	January 2024
Q211	Binder absorption by aggregate	January 2024
Q212B	Binder stripping value – modified plate	January 2024
Q212C	Binder stripping value – immersion tray	January 2024
Q216	Degree of aggregate precoating	January 2024
Q227	Pull-out force for surfacing aggregate	January 2024
Q228	Mill abrasion of aggregate	January 2024
Q229A	Resistance to degradation by abrasion of fine aggregate	January 2024
Q229B	Resistance to degradation by abrasion of coarse aggregate	January 2024
Q230	Particle size distribution and shape – rock	January 2024

<b>Part 7 (cont)</b>	<b>Aggregates</b>	
Q231	Susceptibility of large armour rock to breakdown – drop test	January 2024
Q232	Size distribution and shape – armour stone	January 2024
Q233	Deleterious fines index of fine aggregate	January 2024
<b>Part 8</b>	<b>Asphalt</b>	
Q303A	Preparation of asphalt core samples	January 2024
Q303B	Preparation of asphalt mix from a core sample	January 2024
Q304A	Permeability of asphalt – ponding method	January 2024
Q304B	Assessment of asphalt permeability	May 2024
Q305	Stability, flow and stiffness of asphalt – Marshall	May 2024
Q306C	Compacted density of asphalt – silicone sealed	January 2024
Q306E	Compacted density of asphalt – nuclear gauge	January 2024
Q308A	Binder content and aggregate grading of asphalt – reflux method	January 2024
Q308C	Binder content and aggregate grading of emulsion based cold mix	January 2024
Q309	Preparation and testing of asphalt mix	January 2024
Q311	Voids properties for compacted asphalt	January 2024
Q317	Binder film index of asphalt	January 2024
Q318	Mix volume ratio of stone mastic asphalt	January 2024
Q321	Fixed and free binder in asphalt	January 2024
Q323	Equivalent compaction temperature of warm mix asphalt	January 2024
Q324	Rapid drying of compacted asphalt specimens – vacuum	January 2024
Q325	Stability of asphalt – Hamburg wheel tracker (HWT)	January 2024
Q327	Richness modulus of asphalt	January 2024
<b>Part 9</b>	<b>Bituminous materials</b>	
Q364	Recovery of polymer modified binder from polymer modified emulsion	January 2024
Q372	Cutter content of bituminous materials – modified Dean and Stark	January 2024
Q374	Density of petroleum products	January 2024
Q386	Penetration index of bitumen	January 2024
<b>Part 10</b>	<b>Concrete</b>	
Q460A	Compressive stress and recovery of preformed joint filler	January 2024
Q460B	Extrusion of preformed joint filler	January 2024
Q460C	Expansion of preformed self-expanding joint filler	January 2024
Q460D	Accelerated weathering of preformed joint filler	January 2024
Q460E	Resistance to heat degradation of closed cell foam joint filler	January 2024
Q460F	Resistance to disintegration of preformed cork joint filler	January 2024
Q461	Durability of sealant	January 2024

<b>Part 10 (cont)</b>	<b>Concrete</b>	
Q473	Density of hardened concrete – water displacement	January 2024
Q474	Dowel pull-out test	January 2024
Q475	Tie bar pull-out test	January 2024
Q477	Foreign materials content of recycled crushed concrete	January 2024
Q478	Stability of super-workable concrete	January 2024
Q479	Water retention of concrete – filtration	January 2024
Q480	Relaxation of pre-stressing and post tensioning material	January 2024
Q485	Carbonation depth of concrete	January 2024
<b>Part 11</b>	<b>Chemical</b>	
Q603	Heat stability of bitumen anti-stripping agent	January 2024
Q604	Pourability of a liquid bitumen anti-stripping agent	January 2024
<b>Part 12</b>	<b>Pavements</b>	
Q704	Skid resistance – portable pendulum	January 2024
Q707A	Permeability of road surfacing and granular materials – even flow field permeameter	January 2024
Q707B	Permeability of road surfacing and granular materials – rapid flow field permeameter	January 2024
Q708B	Road roughness – surface evenness – two laser profilometer	January 2024
Q708C	Road roughness – surface evenness – static level and staff	January 2024
Q708D	Road roughness – surface evenness – walking profiler	January 2024
Q711A	Field spread rate of cover aggregate – canvas mat	January 2024
Q712	Surface evenness of road surface – three metre straightedge	January 2024
Q713	Skid resistance – mobile, variable slip technique	January 2024
Q714	Skid resistance – mobile, continuous reading, fixed slip technique	January 2024
Q719	Field spread rate of solid stabilising agents – fabric mat	January 2024
Q720	Loose aggregate on sprayed seals	January 2024
Q721	Torsional shear strength of pavement layers	January 2024
Q723	Proof rolling test	January 2024

## Introduction

### 1 Scope

The Materials Testing Manual (MTM) is published to assist the Department of Transport and Main Roads in the design, construction and maintenance of the state road network.

The 5<sup>th</sup> Edition of the MTM was published in 2018 and is available in electronic form only.

To reduce costs for industry, the MTM contains a 'Table of Equivalencies' so that testing laboratories will no longer need to obtain separate National Association of Testing Authorities (NATA) accreditations for identical Test Methods.

The methods published in the MTM are also referenced in the following departmental publications:

- [Pavement Design Supplement](#): *Supplement to Part 2 Pavement Structural Design of the Austroads Guide to Pavement Technology*
- [Pavement Rehabilitation Manual](#)
- [Technical Specifications](#), and
- [Western Queensland Best Practice Guidelines](#).

### 2 Content

The MTM contains 12 parts as follows:

- a) Part 1 *Introduction*
- b) Part 2 *Application*
- c) Part 3 *General*
- d) Part 4 *Sampling*
- e) Part 5 *Soils, Crushed Rock and Stabilised Materials*
- f) Part 6 *Geotechnical, Environmental, Rock*
- g) Part 7 *Aggregates*
- h) Part 8 *Asphalt*
- i) Part 9 *Bituminous materials*
- j) Part 10 *Concrete*
- k) Part 11 *Chemical*, and
- l) Part 12 *Pavements*.

### 3 Definitions

#### 3.1 Standard definitions

The standard definitions listed in Table 3.1 shall apply to the MTM.



**Table 3.1 – Standard definitions**

Term	Definition
Bulk sample	Produced by taking a set of sample increments of approximately equal quantities from a lot, and thoroughly mixing to provide a single uniform sample. A bulk sample may be reduced by sample division.
Constant mass	<p>Where oven drying to constant mass is specified using a 105-110°C drying oven, the sample is considered to have reached a constant mass when the difference between successive determinations of mass, after additional drying for not less than 30 minutes, does not exceed 0.1 per cent of the original mass of the sample.</p> <p>Where oven drying to constant mass is specified using a 45-50°C drying oven, the sample is considered to have reached a constant mass when the difference between successive determinations of mass, after additional drying for not less than four hours, does not exceed 0.1 per cent of the original mass of the sample.</p> <p>Where Test Methods require different temperatures, drying times or techniques, such as vacuum drying, the Test Methods will specify techniques, temperatures and times.</p>
Granular (mechanical) stabilisation	Granular stabilisation is the process of adding another granular material to correct a deficiency in the intrinsic material properties of the parent material. These stabilising materials include natural gravels, crushed rock and fine-grained soils.
Plant-mixed stabilisation	Involves the stationary pug mill mixing of a stabilisation agent with an unbound granular material sourced from a quarry or reclaimed construction and demolition waste (usually concrete). The quality of unbound granular pavement material used in plant mixing, must conform to an unbound pavement specification.
Quarry material	Construction materials that are won by blasting, ripping, or other excavation means for use in their natural state or after processing such as by crushing, screening or combining with other materials.
Sample	The material to be forwarded for examination and/or testing which is representative of a lot. A sample is either a single entity (a spot sample) or more usually a representative sample and derived by combining sample increments of approximately equal quantities from a lot, and thoroughly mixing to provide a single uniform sample and then dividing the sample into a suitable quantity for examination and/or testing.
Sample increment	Is the basic unit of sampling and shall consist of a quantity of material taken from a sampling location. For hand sampling, it may consist of sub-increments combined to form the sample increment.
Sampling location	The location, described in terms of longitudinal, lateral and, if required, vertical distance from where a sample, sample increment or sub-increment is obtained or at which a single insitu test is performed.
Size fraction	The portion of a sample retained between two successive sieves specified for the test.

Term	Definition
Soil	<p>Any naturally occurring deposit forming part of the earth's crust and resulting from weathering or breakdown of rock formation or from decay of vegetation. For the MTM, soil also includes materials produced from rock sources, artificially produced materials, recycled materials and mixture of these materials and stabilising agents, which are used for civil engineering in place of, or in conjunction with naturally occurring materials. Soils may also be defined by size as follows:</p> <ul style="list-style-type: none"> <li>• Coarse-grained - soils that contain, not more than 20% retained on a 37.6 mm test sieve</li> <li>• Medium-grained - soils that contain, not more than 20% retained on a 19.0 mm test sieve, or</li> <li>• Fine-grained - soils that contain, not more than 20% retained on a 2.36 mm test sieve.</li> </ul>
Subsample	Representative portion of a sample which has been divided from the sample using procedures detailed in the method.
Test location	The location, described in terms of longitudinal, lateral and, if required, vertical distance from where a single insitu test is performed.
Test portion	The material derived from a sample or a subsample by further division and used for a test.
Unbound materials	Quarry materials, natural gravels or recycled materials produced for base and sub-base pavement construction.

### 3.2 Definitions in other publications

Further relevant definitions are contained in the following [Austroads](#) publication and Transport and Main Roads [Technical Specifications](#):

- a) *Austroads Glossary of Terms*
- b) *MRTS01 Introduction to Technical Specifications*
- c) *MRTS04 General Earthworks*
- d) *MRTS05 Unbound Pavements*
- e) *MRTS06 Reinforced Soil Walls*
- f) *MRTS07A Insitu Stabilised Subgrades using Quicklime or Hydrated Lime*
- g) *MRTS07B Insitu Stabilised Pavements using Cement or Cementitious Blends*
- h) *MRTS07C Insitu Stabilised Pavements using Foamed Bitumen*
- i) *MRTS08 Plant-Mixed Heavily Bound (Cemented) Pavements*
- j) *MRTS09 Plant-Mixed Foamed Bitumen Stabilised Pavements*
- k) *MRTS10 Plant-Mixed Lightly Bound Pavements*
- l) *MRTS43 Supply of Armourstone, and*
- m) *MRTS115 Insitu Stabilised Subbases using Triple Blend.*

### 3.3 Standard abbreviations

The standard abbreviations listed in Table 3.3 shall apply to the MTM.

**Table 3.3 – Standard abbreviations**

<b>Abbreviation</b>	<b>Definition</b>
ALI	Available Lime Index
AR	Analytical Reagent
ARRB	Australian Road Research Board, now known as NRTO
ASTM	ASTM International, formerly the American Society for Testing and Materials
AWT	Allowable Working Time
BPN	British Pendulum Number
CR	Capillary Rise
DG	Dense-graded asphalt
DoS	Degree of Saturation
GG	Gap-graded asphalt
HMA	Hot Mix Asphalt
IRHD	International Rubber Hardness Degrees
LL	Liquid Limit
LR	Laboratory Reagent
LVDT	Linear Variable Displacement Transducer
NACOE	National Asset Centre of Excellence
NTR0	National Transport Research Organisation, formerly ARRB
OG	Open-graded asphalt
PIARC	World Road Association
RLT	Repeated Load Triaxial
SDS	Safety Data Sheet
TG	Technical Grade
WLS	Weighted Linear Shrinkage
WMA	Warm Mix Asphalt

### **3.4 Abbreviations in other publications**

Further relevant abbreviations are contained in the [Austroads Glossary of Terms](#).

## **4 Referenced documents**

### **4.1 Australian Standards**

Table 4.1 lists the [Australian Standards](#) including [Austroads Test Methods](#) referenced in the MTM.

**Table 4.1 – Referenced Australian Standards**

<b>Reference</b>	<b>Title</b>
AG:AM/T002	<i>Validation of an Inertial Profilometer for Measuring Pavement Roughness (Reference Device Method)</i>

<b>Reference</b>	<b>Title</b>
AG:AM/T003	<i>Validation of an Inertial Profilometer for Measuring Pavement Roughness (Loop Method)</i>
AG:AM/T005	<i>Distance measurement validation of road condition monitoring vehicles</i>
AG:PT/T220	<i>Sample preparation – Compaction of asphalt slabs</i>
AG:PT/T234	<i>Asphalt binder content (ignition oven method)</i>
AG:PT/T236	<i>Asphalt particle loss</i>
AG:PT/T301	<i>Determining the foaming characteristics of bitumen</i>
AS 1012.1	<i>Methods of testing concrete, Method 1: Sampling of concrete</i>
AS 1012.2	<i>Methods of testing concrete, Method 2: Preparing concrete mixes in the laboratory</i>
AS 1012.3.1	<i>Methods of testing concrete, Method 3.1: Determination of properties related to the consistency of concrete – Slump test</i>
AS 1012.3.5	<i>Methods of testing concrete, Method 3.5: Determination of properties relating to the consistency of concrete – Slump flow, <math>T_{500}</math> and J-ring test</i>
AS 1012.8.1	<i>Methods of testing concrete, Method 8.1: Method for making and curing concrete – Compression and indirect tensile test specimens</i>
AS 1012.8.3	<i>Methods of testing concrete, Method 8.3: Methods of making and curing concrete – Mortar and grout specimens</i>
AS 1012.8.4	<i>Methods of testing concrete, Method 8.4: Method for making and curing concrete – Drying shrinkage specimens prepared in the field or in the laboratory</i>
AS 1012.9	<i>Methods of testing concrete, Method 9: Compressive strength tests – Concrete, mortar and grout specimens</i>
AS 1012.13	<i>Methods of testing concrete, Method 13: Determination of the drying shrinkage of concrete for samples prepared in the field or in the laboratory</i>
AS 1012.14	<i>Methods of testing concrete, Method 14: Method for securing and testing cores from hardened concrete for compressive strength and mass per unit volume</i>
AS 1141.2	<i>Methods for sampling and testing aggregates, Method 2: Basic testing equipment</i>
AS 1141.3.1	<i>Methods for sampling and testing aggregates, Method 3.1: Sampling – Aggregates</i>
AS 1141.4	<i>Methods for sampling and testing aggregates, Method 4: Bulk density of aggregate</i>
AS 1141.5	<i>Methods for sampling and testing aggregates, Method 5: Particle density and water absorption of fine aggregate</i>
AS 1141.6.1	<i>Methods for sampling and testing aggregates, Method 6.1: Particle density and water absorption of coarse aggregate – Weighing-in-water method</i>
AS 1141.11.1	<i>Methods for sampling and testing aggregates, Method 11.1: – Particle size distribution – Sieving method</i>
AS 1141.15	<i>Methods for sampling and testing aggregates, Method 15: Flakiness index</i>
AS 1141.22	<i>Methods for sampling and testing aggregates, Method 22: Wet / dry strength variation</i>

<b>Reference</b>	<b>Title</b>
AS 1141.23	<i>Methods for sampling and testing aggregates, Method 23: Los Angeles value</i>
AS 1141.40	<i>Methods for sampling and testing aggregates, Method 40: Polished aggregate friction value – Vertical road-wheel machine</i>
AS 1141.42	<i>Methods for sampling and testing aggregates, Method 42: Pendulum friction test</i>
AS 1141.50	<i>Methods for sampling and testing aggregates, Method 50: Resistance to stripping of cover aggregates from binders</i>
AS/NZS 1141.7	<i>Methods for sampling and testing aggregates, Method 7: Apparent particle density of filler</i>
AS 1289.0	<i>Methods of testing soils for engineering purposes, Part 0: Definitions and general requirements</i>
AS 1289.1.2.1	<i>Methods of testing soils for engineering purposes, Method 1.2.1: Sampling and preparation of soils – Disturbed samples – Standard method</i>
AS 1289.1.4.1	<i>Methods of testing soils for engineering purposes, Method 1.4.1: Sampling and preparation of soils – Selection of sampling or test sites – Random number method</i>
AS 1289.1.4.2	<i>Methods of testing soils for engineering purposes, Method 1.4.2: Sampling and preparation of soils – Selection of sampling or test sites – Stratified random number method</i>
AS 1289.2.1.1	<i>Methods of testing soils for engineering purposes, Method 2.1.1: Soil moisture content tests – Determination of the moisture content of a soil – Oven drying method (standard method)</i>
AS 1289.2.1.2	<i>Methods of testing soils for engineering purposes, Method 2.1.2: Soil moisture content tests – Determination of the moisture content of a soil – Sand bath method (subsidiary method)</i>
AS 1289.2.1.4	<i>Methods of testing soils for engineering purposes, Method 2.1.4: Soil moisture content tests – Determination of the moisture content of a soil – Microwave-oven drying method (subsidiary method)</i>
AS 1289.2.1.5	<i>Methods of testing soils for engineering purposes, Method 2.1.5: Soil moisture content tests – Determination of the moisture content of a soil – Infrared lights method (subsidiary method)</i>
AS 1289.2.1.6	<i>Methods of testing soils for engineering purposes, Method 2.1.6: Soil moisture content tests – Determination of the moisture content of a soil – Hotplate drying method</i>
AS 1289.2.3.1	<i>Methods of testing soils for engineering purposes, Method 2.3.1: Soil moisture content tests – Establishment of correlation – Subsidiary method and the standard method</i>
AS 1289.3.1.1	<i>Methods of testing soils for engineering purposes, Method 3.1.1: Soil classification tests – Determination of the liquid limit of a soil – Four point Casagrande method</i>
AS 1289.3.1.2	<i>Methods of testing soils for engineering purposes, Method 3.1.2: Soil classification tests – Determination of the liquid limit of a soil – One point Casagrande method (subsidiary method)</i>
AS 1289.3.2.1	<i>Methods of testing soils for engineering purposes, Method 3.2.1: Soil classification tests – Determination of the plastic limit of a soil – Standard method</i>

<b>Reference</b>	<b>Title</b>
AS 1289.3.3.1	<i>Methods of testing soils for engineering purposes, Method 3.3.1: Soil classification tests – Calculation of the plasticity index of a soil</i>
AS 1289.3.3.2	<i>Methods of testing soils for engineering purposes, Method 3.3.2: Soil classification tests – Calculation of the cone plasticity index of a soil</i>
AS 1289.3.4.1	<i>Methods of testing soils for engineering purposes, Method 3.4.1: Soil classification tests – Determination of the linear shrinkage of a soil – Standard method</i>
AS 1289.3.5.1	<i>Methods of testing soils for engineering purposes, Method 3.5.1: Soil classification tests – Determination of the soil particle density of a soil – Standard method</i>
AS 1289.3.6.1	<i>Methods of testing soils for engineering purposes, Method 3.6.1: Soil classification tests – Determination of the particle size distribution of a soil – Standard method of analysis by sieving</i>
AS 1289.3.6.3	<i>Methods of testing soils for engineering purposes, Part 3.6.3: Soil classification tests – Determination of the particle size distribution of a soil – Standard method of fine analysis using a hydrometer</i>
AS 1289.4.2.1	<i>Methods of testing soils for engineering purposes, Method 4.2.1: Soil chemical tests – Determination of the sulfate content of a natural soil and the sulfate content of the groundwater – Normal method</i>
AS 1289.5.1.1	<i>Methods of testing soils for engineering purposes, Method 5.1.1: Soil compaction and density tests – Determination of the dry density / moisture content relation of a soil using standard compactive effort</i>
AS 1289.5.4.1	<i>Methods of testing soils for engineering purposes, Method 5.4.1: Soil compaction and density tests – Compaction control test – Dry density ratio, moisture variation and moisture ratio</i>
AS 1289.5.5.1	<i>Methods of testing soils for engineering purposes, Method 5.5.1: Soil compaction and density tests – Determination of the minimum and maximum dry density of a cohesionless material – Standard method</i>
AS 1289.5.7.1	<i>Methods of testing soils for engineering purposes, Method 5.7.1: Soil compaction and density tests – Compaction control test – Hilf density ratio and Hilf moisture variation (rapid method)</i>
AS 1289.6.1.1	<i>Methods of testing soils for engineering purposes, Method 6.1.1: Soil strength and consolidation tests – Determination of the California Bearing Ratio of a soil - Standard laboratory method for a remoulded specimen</i>
AS 1289.6.3.2	<i>Methods of testing soils for engineering purposes, Method 6.3.2: Soil strength and consolidation tests – Determination of the penetration resistance of a soil – 9 kg dynamic cone penetrometer test</i>
AS 1289.6.4.1	<i>Methods of testing soils for engineering purposes, Method 6.4.1: Soil strength and consolidation tests – Determination of compressive strength of a soil – Compressive strength of a specimen tested in undrained triaxial compression without measurement of pore water pressure</i>
AS 1349	<i>Bourdon tube pressure and vacuum gauges</i>
AS 1545	<i>Methods for the calibration and grading of extensometers</i>
AS 1672.1	<i>Limes and limestones, Part 1: Limes for building</i>
AS 2008	<i>Bitumen for pavements</i>
AS 2193	<i>Calibration and classification of force-measuring systems</i>

<b>Reference</b>	<b>Title</b>
AS 2341.3	<i>Methods of testing bitumen and related roadmaking products, Method 3: Determination of kinematic viscosity by flow through a capillary tube</i>
AS 2341.7	<i>Methods of testing bitumen and related roadmaking products, Method 7: Determination of density using a density bottle</i>
AS 2341.12	<i>Methods of testing bitumen and related roadmaking products, Method 12: Determination of penetration</i>
AS 2341.18	<i>Methods of testing bitumen and related roadmaking products, Method 18: Determination of softening point (ring and ball method)</i>
AS/NZS 2341.2	<i>Methods of testing bitumen and related roadmaking products, Method 2: Determination of dynamic viscosity by vacuum capillary viscometer</i>
AS/NZS 2341.29	<i>Methods of testing bitumen and related roadmaking products, Method 29: Determination of breaking behaviour by setting time</i>
AS 2891.1.2	<i>Methods of sampling and testing asphalt, Method 1.2: Sampling – Coring method</i>
AS/NZS 2891.1.1	<i>Methods of sampling and testing asphalt, Method 1.1: Sampling – Loose asphalt</i>
AS/NZS 2891.2.2	<i>Methods of sampling and testing asphalt, Method 2.2: Sample preparation – Compaction of asphalt test specimens using a gyratory compactor</i>
AS/NZS 2891.3.1	<i>Methods of sampling and testing asphalt, Method 3.1: Binder content and aggregate grading – Reflux method</i>
AS/NZS 2891.5	<i>Methods of sampling and testing asphalt, Method 5: Compaction of asphalt by Marshall method and determination of stability and flow – Marshall procedure</i>
AS/NZS 2891.7.1	<i>Methods of sampling and testing asphalt, Method 7.1: Determination of maximum density of asphalt – Water displacement method</i>
AS/NZS 2891.8	<i>Methods of sampling and testing asphalt, Method 8: Voids and volumetric properties of compacted asphalt mixes</i>
AS/NZS 2891.9.2	<i>Methods of sampling and testing asphalt, Method 9.2: Determination of bulk density of compacted asphalt – Presaturation method</i>
AS/NZS 2891.9.3	<i>Methods of sampling and testing asphalt, Method 9.3: Determination of bulk density of compacted asphalt – Mensuration method</i>
AS/NZS 2891.13.1	<i>Methods of sampling and testing asphalt, Method 13.1: Determination of the resilient modulus of asphalt – Indirect tensile method</i>
AS 3706.1	<i>Geotextiles – Methods of test, Method 1: General requirements, sampling, conditioning, basic physical properties and statistical analysis</i>
AS 3706.4	<i>Geotextiles – Methods of test, Method 4: Determination of burst strength – California bearing ratio (CBR) – Plunger method</i>
AS 3706.5	<i>Geotextiles – Methods of test, Method 5: Determination of puncture resistance – Drop cone method</i>
AS 4489.6.1	<i>Test methods for limes and limestones. Method 6.1: Lime index – Available lime</i>
AS 4663	<i>Slip resistance measurement of existing pedestrian surfaces</i>
ATM 250	<i>Modified surface texture depth (pestle method)</i>
NSW T171	<i>Modified Texas triaxial compression test for pavement materials</i>

## 4.2 International Standards

Table 4.2 lists the International Standards referenced in the MTM.

**Table 4.2 – Referenced International Standards**

<b>Reference</b>	<b>Title</b>
ASTM C295	<i>Standard Guide for Petrographic Examination of Aggregates for Concrete</i>
ASTM C1611	<i>Standard test method for slump flow of self-consolidating concrete</i>
ASTM D5	<i>Standard test method for penetration of bituminous materials</i>
ASTM D5581	<i>Standard Test Method for Resistance to Plastic Flow of Bituminous Mixtures Using Marshall Apparatus (6 inch-Diameter Specimen)</i>
ASTM E1859	<i>Standard test method for Friction Coefficient Measurements Between Tire and Pavement Using a Variable Slip Technique</i>
ASTM E1926	<i>Standard practice for computing International Roughness Index of roads from profile measurements</i>
BS 658	<i>Specification for apparatus for the determination of distillation range (including flasks and receivers)</i>
BS EN 1426	<i>Bitumen and bituminous binders – Determination of needle penetration</i>
BS ISO 48	<i>Rubber, vulcanized or thermoplastic. Determination of hardness (hardness between 10 IRHD and 100 IRHD)</i>
CIA Z17	<i>Recommended Practice, Tremie Concrete for Deep Foundations</i>
EN 13383-1	<i>Armour stone Part 1 Specification</i>
EN 13383-2	<i>Armour stone Part 2 Test Methods</i>
EN 16165	<i>Determination of slip resistance of pedestrian surfaces – Methods of evaluation</i>
ISO 463	<i>Geometrical Product Specifications (GPS) – Dimensional measuring equipment – Design and metrological characteristics of mechanical dial gauges</i>
ISO 3310-1	<i>Test sieves – Technical requirements and testing – Part 1: Test sieves of metal wire cloth</i>
ISO 3310-2	<i>Test sieves – Technical requirements and testing – Part 2: Test sieves of perforated metal plate</i>
ISO 4788	<i>Laboratory glassware – Graduated measuring cylinders</i>
ISO 6789	<i>Assembly tools for screws and nuts – Hand torque tools – Part 1: Requirements and methods for design conformance testing and quality conformance testing: minimum requirements for declaration of conformance</i>
ISO 8486-2	<i>Bonded abrasives – Determination and designation of grain size distribution – Part 2: Microgrits F230 to F2000</i>
ISO 13385-1	<i>Geometrical Product Specifications (GPS) – Dimensional measuring equipment – Part 1: Callipers; Design and metrological characteristics of mechanical dial gauges</i>
JIS B 7503	<i>Mechanical dial gauges</i>
JIS B 7507	<i>Vernier, dial and digital callipers</i>



## 5 Using other standards

The Transport and Main Roads Technical Specifications require that the testing of all work carried out within a Contract shall be undertaken in accordance with Test Methods in the MTM or, where specified, from national standards. Where these Test Methods are referenced in the MTM and Transport and Main Roads Specifications Manual, they are prefixed as follows:

- a) 'Q' for Test Methods published in the *Materials Testing Manual*
- b) 'N' for Test Methods published in the [Nuclear Gauge Testing Manual](#)
- c) 'AS' for Test Methods published by Australian Standards
- d) 'AS/NZS' for Test Methods jointly published by Standards Australia and Standards New Zealand
- e) 'AG AM/T', 'AG:PT/T' or 'ATM' for Test Methods published by Austroads
- f) 'ASTM' for Test Methods published by ASTM International, formerly the American Society for Testing and Materials, or
- g) 'T' for Test Methods published by Transport for New South Wales, formerly Roads and Maritime Services New South Wales.

The original issue of the MTM contained only full Test Methods published by the then Department of Main Roads. Since the early 1980s, the MTM has referred to other Test Methods and Standards, initially for concrete testing but expanding to include the testing of soils, aggregates, asphalt and other bituminous materials.

The current MTM contains the following:

- Test Methods that directly reference existing Test Methods (for example, Australian Standards, Austroads)
- Test Methods that reference other Test Methods but include some mandatory variations, and
- full Test Methods either developed in-house or based on existing Test Methods.

## 6 Safety

This MTM does not attempt to address all safety concerns, if any, associated with its use. It is the responsibility of the user of this MTM to establish appropriate occupational health and safety practices that meet statutory regulations.

## 7 Notes

Information contained in sections with the heading 'Notes on method' is for guidance in understanding or clarifying the associated requirement.

## 8 Approved Test Methods (table of equivalencies)

A list of Test Methods that are approved as replacements for Transport and Main Roads Test Methods or National Test Methods nominated in Transport and Main Roads [Technical Specifications](#) are shown in Table 8.

**Table 8 – Approved replacement methods**

<b>Test Method in Transport and Main Roads Technical Specification</b>	<b>Equivalent</b>	<b>Test Method in Transport and Main Roads Technical Specification</b>	<b>Equivalent</b>
AG:PT/T232	ATM 232	Q202	AS 1141.20.3
Q050	AS 1289.1.4.1	Q203	AS 1141.42 and AS 1141.40
Q050	AS 1289.1.4.2	Q205A	AS 1141.22
Q060	AS 1141.3.1	Q205B	AS 1141.22
Q101E	T102 + T103	Q205C	AS 1141.22
Q105	AS 1289.3.3.1 or AS 1289.3.3.2	Q306B	AS 2891.9.2
Q122A	AS 1289.4.4.1	Q307A	AS 2891.7.1
Q122B	AS 1289.4.4.1	Q308D	AG:PT/T234
Q136	Q136A	Q315	AG:PT/T232
Q130A	ATM 710	Q478	ASTM C 1611
Q130B	ATM 710	Q479	CIA Z17
Q131B	AS 1289.4.2.1	Q723	T198
Q201	AS 1141.15	-	-

AS – Australian Standard

AS/NZS – Joint Australian / New Zealand Standard

AG:PT/T or ATM – Austroads

ASTM – ASTM International, formerly American Society for Testing and Materials

CIA – Concrete Institute of Australia

T – Transport for New South Wales, formerly Roads and Maritime Services, New South Wales

## Application

### 1 Purpose

This part of the MTM provides guidance for construction materials testing facilities on the use of Test Methods for the following:

- testing of stabilised materials (Parts 3–7), and
- storage of additives in the laboratory (Part 8).

This guidance reflects departmental experience and is intended to assist testing facilities in performing testing conforming to requirements of the relevant Test Methods, documents referenced following and the relevant [Technical Specifications](#).

### 2 Referenced documents

The documents referenced by this part of the MTM are shown following:

- [Pavement Rehabilitation Manual](#), Queensland Department of Transport and Main Roads.
- [Guide to Pavement Technology Part 4D: Stabilised Materials](#), Austroads, 2019.
- *Geotechnical Site Investigations*, [Standards Australia](#), AS 1726-2017, Section 6.1 *Soil description and classification*.
- [Nuclear Gauge Testing Manual](#), Queensland Department of Transport and Main Roads.
- [Pavement Design Supplement](#), *Supplement to Part 2: Pavement Structural Design of Austroads Guide to Pavement Technology*, Queensland Department of Transport and Main Roads.
- *Stabilization of pavement, subgrades and base courses with lime*, Dallas N Little, National Lime Association, Kendall Hunt Publishing Company, 1995.

### 3 Testing of materials for insitu cement or cementitious blend stabilisation

#### 3.1 Introduction

This part outlines the process for:

- a) sampling and characterising host soil
- b) design procedure to determine the relationship between unconfined compressive strength and stabilising agent content
- c) determining working time, and
- d) measuring the properties of cement treated materials in the field.

This part supports the application of the following departmental documents:

- [Technical Specification MRTS07B](#) *Insitu Stabilised Pavements using Cement or Cementitious Blends*
- Technical Specification MRTS115 *Insitu Stabilised Subbases using Triple Blend* and
- [Pavement Rehabilitation Manual](#), Section 4.9.6.

In the remainder of this manual, the term 'cement' can mean both cement and cementitious blends (that is, combinations of pozzolanic material, such as fly ash, slag and so on, and cement and/or lime).

This process is also applicable to materials stabilised using slow setting additives such as lime / fly ash and lime slag, although these require a longer curing time before testing, usually 28 days.

### 3.2 Background

In situ cement or cementitious blend stabilisation is a mobile process, during which cement is added to an existing pavement and mixed with a purpose-designed road recycler.

It is essential, with all stabilisation work, that materials are thoroughly assessed and their reactions with the specific binder to be used in the stabilisation process is properly validated by laboratory testing before any field work commences. Stabilised pavement materials should be tested to determine their quality and uniformity.

The summary of the categories and characteristics of the various types of stabilised materials typically adopted by Transport and Main Roads are shown in the *Guide to Pavement Technology Part 4D: Stabilised Materials*, Austroads, Table 2.1.

### 3.3 Sampling and characterisation

#### 3.3.1 General

Sample the section under consideration at appropriate intervals to identify material properties and uniformity using the sampling methods in Table 3.3.1. Use of a soil classification system, such as the Unified Soils Classification system, can assist in identifying the soil types.

For characterisation, bulk samples of 10–50 kg will be required, depending on the maximum particle size of the material. For mix design, an additional bulk sample of 90–120 kg will be required.

It may be necessary to sample the pavement in a manner that simulates both the mixing and the disruption caused by using up to three passes of a stabiliser. A bobcat or excavator fitted with a profiling / milling head can simulate this mixing. Mill a lateral trench using three passes, retaining all the material for the sample. Do not test this material as part of the characterisation of the pavement; retain this material for the mix design in Section 3.4.

Do not sample materials excluded from the works during construction, such as sprayed surfacing, asphalt, or stabilised patches. Before commencing any sampling, obtain clarification of excluded areas.

Sample any material to be imported to add to the pavement for in situ stabilisation at its source, usually a quarry, to obtain a representative sample of the material.

**Table 3.3.1 – Test Methods used to sample materials**

Property	Test Method	Title
Sampling – machine excavated pit or trench	AS 1289.1.2.1	Sampling and preparation of soils – disturbed samples
Sampling from stockpile	AS 1141.3.1	Sampling - Aggregates
Sampling for stabilisation testing – plant excavation	Q061	Spot sampling of soils, crushed rock and aggregates

### 3.3.2 Classification

Undertake particle size distribution and Atterberg limits testing using Test Methods listed in Table 3.3.2 on the samples. Use the results of particle size distribution, Atterberg limits and visual classification to classify the material sampled and to gain a preliminary assessment of the type of stabilisation suitable samples tested. Refer to *Guide to Pavement Technology Part 4D: Stabilised Materials*, Austroads, Table 2.4 or *Pavement Rehabilitation Manual*, Table 4.9 for details. These results are also used to select representative samples for further testing.

**Table 3.3.2 – Test Methods used to classify materials**

Property	Test Method	Title
Particle Size Distribution (Grading)	Q103A	Particle size distribution of soil – wet sieving
Atterberg limits (liquid limit, plastic limit, plasticity index and linear shrinkage)	Q104A or D	Liquid limit of soil
	Q105	Plastic limit and plasticity index of soil
	Q106	Linear shrinkage of soil

### 3.3.3 Deleterious materials

This is usually not an issue for materials obtained from quarries or existing pavement materials originally obtained from quarries or pits. If there is a concern about the quality of the materials, then testing for deleterious materials in accordance with Section 7.3.2 may be undertaken with the limits in Table 7.3.2 adopted.

### 3.4 Mix design procedure

This stage is to establish the target cement content for the host soil using the design Test Methods in Table 3.4.

**Table 3.4 – Test Methods used for design**

Property	Test Method	Title
Unconfined Compressive Strength (UCS)	Q115	UCS of stabilised materials
	Q135A	Addition of stabilising agents
	Q251A	Preparation and compaction of laboratory mixed stabilised materials
	Q135B	Curing of moulded specimens of stabilised materials
Capillary rise	Q125D	Capillary rise of stabilised material
AWT	Q136A	Working time of stabilised materials

#### 3.4.1 Cement and supplementary cementitious materials

Where required, cement conforming to the requirements of AS 3972: *General purpose and blended cements* is used in laboratory testing. Source the cement directly from suppliers. Do not use bagged supplies from hardware stores / building suppliers, as the age and condition of the cement is unknown. Instructions for the storage and use of cement are included in Section 8.

Source supplementary cementitious materials (fly ash, slag, silica fume and so on) directly from suppliers and keep dry in airtight containers. Source any admixtures directly from suppliers. Instructions for storage and use are included in Section 8.

### **3.4.2 Lime**

Where required hydrated lime, conforming to the requirements of Technical Specification MRTS23 *Supply and Delivery of Quicklime and Hydrated Lime for Road Stabilisation*, is to be used exclusively in laboratory testing. Source the hydrated lime directly from suppliers. Do not use bagged supplies from hardware stores / building suppliers, as the age and condition of the lime is unknown. Instructions for the storage and use of lime are included in Section 8.

Obtain a certificate with the ALI ( $AL_x$ ) from the supplier for the batch of lime. As an alternative, sample the lime and forward the sample to a laboratory to determine the ALI. Forward the ALI certificate, along with other results of testing for the mix design procedure.

Do not use quicklime in the laboratory because of safety concerns, and the need to exercise very tight control over moisture during moulding. If complete hydration of the quicklime does not occur before compaction, carbonation and localised expansion can occur.

### **3.4.3 Water**

Water sources classified by the relevant water authority as 'potable water' do not require any testing. Where other water is used, such as site water, dam water and so on, it shall conform with the requirements in Technical Specification MRTS07B *In situ Stabilised Pavements using Cement or Cementitious Blends*, Clause 6.5 *Water quality*.

### **3.4.4 Imported material**

Where imported material is required, use material conforming to the requirements of Technical Specification MRTS05 *Unbound Pavements* in laboratory testing. Source the material directly from the nominated quarry. Add the imported material to the representative samples for the UCS design in proportions nominated by the designer.

### **3.4.5 UCS test analysis**

Use the UCS test to determine the stabilising agent target content. Compact at least three test portions (minimum three specimens at each) at a range of cement contents. The range of cement contents should straddle the target strength with at least one portion below the target strength and one portion above the target strength. Compact additional portions, if required, to straddle the required target strength. The user of the data must be able to interpolate and not extrapolate.

There is a significant influence by density of the strength of all compacted soil. A 1% reduction in relative compaction can reduce the UCS by 5%. Small density variations can easily mask the effects of other variables such as cement content and curing conditions.

Since compacted density has a direct influence on UCS, variation in compaction moisture must be limited. Suggested limit for achieved moisture content are:

$$\text{Achieved moisture content} = \text{target moisture content} \pm 0.3 \text{ percentile units}$$

Condition the cement / soil mixture using short-term conditioning; that is, the cement / soil mixture is to condition in an airtight container for 45 minutes before further mixing and compaction.

A standard curing regime comprising moist curing at  $23 \pm 2^\circ\text{C}$  for seven days has been adopted in accordance with Test Method Q135B.

All specimens are to be tested using the standard UCS Test Method Q115.

Plot the UCS data versus cement content and determine the cement content corresponding to the target strength (MPa). In Figure 3.4.5, the cement content corresponding with the target strength of 1.5 MPa would be the optimum cement content of 1.65%.

**Figure 3.4.5 – Cement content v UCS**

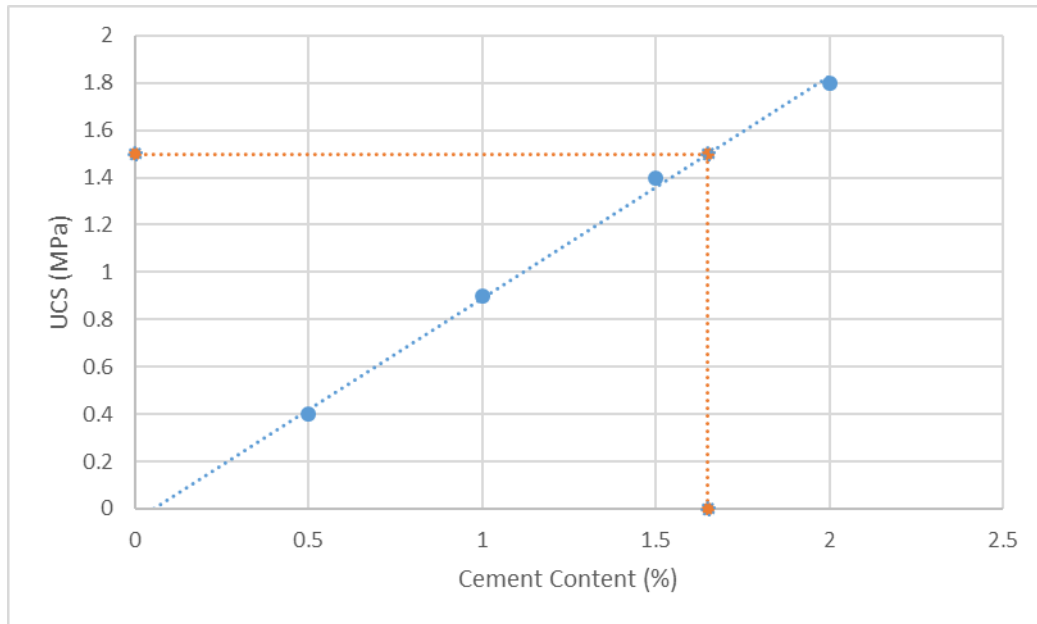

### 3.4.6 Allowable working time

The AWT for cement stabilised materials is two hours in accordance with Technical Specification MRTS07B *In situ Stabilised Pavements using Cement or Cementitious Blends*, Clause 8.4 *Allowable working time* or 3.5 hours in accordance with Technical Specification MRTS115 *In situ Stabilised Subbases using Triple Blend* unless specified in the annexure to these Technical Specifications.

Alternatively, the AWT may be determined in accordance with Technical Specification MRTS07B *In situ Stabilised Pavements using Cement or Cementitious Blends*, Clause 8.4 *Allowable working time* or 3 Technical Specification MRTS115 *In situ Stabilised Subbases using Triple Blend*, Clause 8.4 *Allowable working time* using Test Method Q136A.

To determine the AWT, undertake the test to determine the AWT for the stabilising agent and host soil. Compact specimens with a one-hour delay and determine the dry density and UCS to establish a reference maximum dry density MDD and reference UCS. Further specimens are compacted with a delay between mixing and compaction which, for cements, will typically be one, two, four, six and eight hours.

These delays reduce the achieved MDD and UCS due to the cement hydrating and reacting with the host soil, reducing the moisture content and increasing the friction between particles. These effects inhibit the reorientation of particles during compaction and therefore reduce the achieved MDD. The lower density also reduces the achieved UCS.

The AWT is defined as the delay time that produces a 3% reduction in achieved MDD (that is, 100% to 97%); or a 20% reduction in achieved UCS (that is, 100% to 80%), whichever is the shorter delay time.

Plot the MDD versus time delay and the UCS versus time delay for the cement content and determine the delay at 0.97 of one hour delay MDD ( $0.97 \times 2.200 = 2.134$ ) and 0.80 of one hour delay UCS ( $0.80 \times 1.5 = 1.2$ ). In Figure 3.4.6, the delays corresponding 0.97 MDD and 0.80 UCS are five and four hours respectively; therefore, the AWT would be four hours.

**Figure 3.4.6 – MDD / UCS v delay**

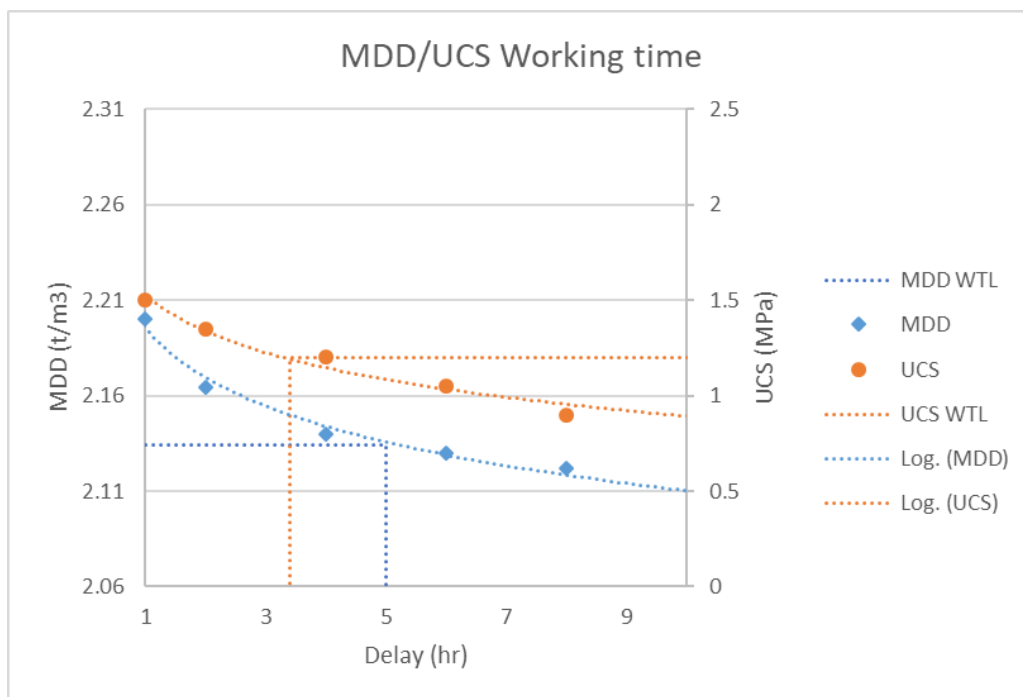

### 3.5 Field testing - compliance

Undertake field testing to ensure that specification requirements, such as cement content, relative compaction, moisture content and UCS are achieved using the test methods in Table 3.5.



**Table 3.5 – Test methods used for compliance**

Property	Test Method	Title
Spread rate	Q719	Field spread rate of solid stabilising agents – fabric mat
Compacted density	Q141A	Compacted density of soils and crushed rock (nuclear gauge)
	Q141B	Compacted density of soils and crushed rock (sand replacement)
MDD / OMC	Q142A	Dry density-moisture relationship (standard compaction)
	Q144A	Assignment of MDD and optimum moisture content for soils and crushed rock
Relative compaction	Q140A	Relative compaction of soils and crushed rock
AWT	Q136A	Working time for stabilised materials

### 3.5.1 Cement content

For insitu stabilisation, a simple mat test is used to measure stabilising agent content. Place one or more 1 m<sup>2</sup> mats to catch the discharge from the spreader.

### 3.5.2 Compacted density and MDD / OMC

Use nuclear gauge technique for cement modified / stabilised materials provided a wet density and moisture content bias is determined in accordance with the *Nuclear Gauge Testing Manual*. Use of the sand replacement test for measuring insitu density is an alternative, but it is more destructive to the finished pavement.

Measure the MDD / OMC using the traditional dry density-moisture relationship test. Complete the sampling and compaction of the MDD / OMC sample before the AWT for the material has elapsed. A project / material specific AWT is determined for each project.

The inherent variability of insitu stabilised materials usually means the employment of a testing regime of one-for-one testing. Such testing involves taking a sample from each insitu density location and determining a MDD / OMC.

### 3.5.3 Moisture content of stabilised material

Monitoring and adjustment of the moisture content of the stabilised material is critical to the performance of the finished pavement.

The moisture ratio of the stabilised material after the final wet incorporation of stabilising agent pass but before compaction should be in the range specified in accordance with Technical Specification MRTS07B *Insitu Stabilised Pavements using Cement or Cementitious Blends*, Clause 8.8 *Product standards* or Technical Specification MRTS115 *Insitu Stabilised Subbases using Triple Blend*, Clause 8.7 *Product Standards*.

As a minimum frequency, the relative moisture ratio of stabilised materials is assessed at each test location for compaction tests.

## 3.6 Field testing – verification

Undertake field testing to ensure that design requirement, UCS is achieved using the test method in Table 3.6.

**Table 3.6 – Test methods used for verification**

Property	Test Method	Title
UCS	Q115	UCS of compacted materials
	Q251B	Preparation and compaction of field mixed stabilised materials
	Q135B	Curing of moulded specimens of stabilised material

### 3.6.1 Field UCS

The UCS test provides additional information on expected field performance relative to design. Mould the field mixed material at field moisture content using standard compaction effort. Cure the moulded specimens under standard conditions prior to testing.

When sampling and making UCS specimens in the field, it is assumed the insitu moisture content will be close to the optimum moisture content of the material. If not, then the achieved dry density and dry density ratio will be likely to be well below the target. This will mean the UCS results for the samples will be lower than target, due to the moisture and density being lower than the targets; therefore, care is required in interpreting these results.

## 4 Testing of materials for plant-mixed cement or cementitious blend stabilisation

### 4.1 Introduction

This section outlines the process for:

- a) sampling and characterising host soil
- b) design procedure to determine the relationship between UCS and stabilising agent content, and
- c) measuring the properties of cement treated materials at the production plant and in the field.

This section supports the application of the following departmental documents:

- MRTS08 *Plant-Mixed Heavily Bound (Cemented) Pavements*, and
- MRTS10 *Plant-Mixed Lightly Bound Pavements*.

In the remainder of this document, the term 'cement' can mean both cement and cementitious blends (that is, combinations of pozzolanic material, such as fly ash, slag and so on, and cement and/or lime).

This process is also applicable to materials stabilised using slow setting additives such as lime / fly ash and lime slag although these require a longer curing time before testing, usually 28 days.

### 4.2 Background

Plant-mixed cement stabilisation involves stationary pugmill mixing of cement with an unbound granular material sourced from quarrying or reclaimed construction material. The quality of unbound granular pavement materials used in plant mixing typically conforms to unbound granular specifications for particle size distribution, plasticity and source rock hardness. The stabilised material is delivered to the site in trucks and then paved or spread, compacted, shaped and cured in preparation for the placement of the overlying layers.

It is essential with all stabilisation work that materials are thoroughly assessed and their reactions with the specific binder to be used in the stabilisation process be properly validated by laboratory testing before any field work commences. Stabilised pavement materials should be tested to determine their quality and uniformity.

The summary of the categories and characteristics of the various types of stabilised materials typically adopted by Transport and Main Roads are shown in the *Guide to Pavement Technology Part 4D: Stabilised Materials*, Austroads, Table 2.1.

### 4.3 Sampling and characterisation

The material to be used must be sampled to ensure compliance with the relevant Technical Specification using the sampling method in Table 4.3. For characterisation, bulk samples of 10–50kg will be required, depending on the maximum particle size of the material. For mix design, an additional bulk sample of 90–120kg will be required. Use the sampling methods in Table 4.3.

**Table 4.3 – Test methods used to sample materials**

Property	Test Method	Title
Sampling from stockpile	AS 1141.3.1	Sampling - Aggregates

#### 4.3.1 Classification

Undertake particle size distribution and Atterberg limits testing using test methods listed in Table 4.3.1 on the samples. Use the results of particle size distribution, Atterberg limits and visual classification to classify the material sampled and to gain a preliminary assessment of the type of stabilisation suitable samples tested. Refer to *Guide to Pavement Technology Part 4D: Stabilised Materials*, Austroads, Table 2.4 or *Pavement Rehabilitation Manual*, Table 4.9 for details. These results are also used to select representative samples for further testing.

**Table 4.3.1 – Test methods used to classify materials**

Property	Test Method	Title
Particle Size Distribution (Grading)	Q103A	Particle size distribution of soil – wet sieving
Atterberg limits (Liquid limit, plastic limit, plasticity index and linear shrinkage)	Q104A or D	Liquid limit of soil
	Q105	Plastic limit and plasticity index of soil
	Q106	Linear shrinkage of soil

#### 4.3.2 Deleterious materials

This is usually not an issue for materials obtained from quarries or existing pavement materials originally obtained from quarries or pits. If there is a concern about the quality of the materials, then testing for deleterious materials in accordance with Section 7.3.2 may be undertaken with the limits in Table 7.3.2 adopted.

### 4.4 Mix design procedure

This stage is to establish the target cement content for the host soil.

Use the design test methods in Table 4.4.

**Table 4.4 – Test methods used for design**

Property	Test Method	Title
UCS	Q115	UCS of stabilised materials
	Q135A	Addition of stabilising agents
	Q251A	Preparation and compaction of laboratory mixed stabilised materials
	Q135B	Curing of moulded specimens of stabilised materials
Capillary rise	Q125D	Capillary rise of stabilised material

#### 4.4.1 Cement, supplementary cementitious materials and admixtures

Where required, cement conforming to the requirements of AS 3972: *General purpose and blended cements* is used in laboratory testing. Source the cement directly from suppliers. Do not use bagged supplies from hardware stores / building suppliers, as the age and condition of the cement is unknown. Instructions for the storage and use of cement are included in Section 8.

Source supplementary cementitious materials (fly ash, slag, silica fume and so on) directly from suppliers and keep dry in airtight containers. Instructions for the storage and use of supplementary cementitious materials are included in Section 8. Source any admixtures directly from suppliers. Instructions for storage and use are included in Section 8.

#### 4.4.2 Lime

Where required hydrated lime, conforming to the requirements of Technical Specification MRTS23 *Supply and Delivery of Quicklime and Hydrated Lime for Road Stabilisation*, is to be used exclusively in laboratory testing. Source the hydrated lime directly from suppliers. Do not use bagged supplies from hardware stores / building suppliers, as the age and condition of the lime is unknown. Instructions for the storage and use of lime are included in Section 8.

Obtain a certificate with the ALI ( $AL_x$ ) from the supplier for the batch of lime. As an alternative, sample the lime and forward the sample to a laboratory to determine the ALI. Forward the ALI certificate, along with other results of testing for the mix design procedure.

Do not use quicklime in the laboratory because of safety concerns, and the need to exercise very tight control over moisture during moulding. If complete hydration of the quicklime does not occur before compaction, carbonation and localised expansion can occur.

#### 4.4.3 Water

Water sources classified by the relevant water authority as 'potable water' do not require any testing. Where other water is used, such as site water, dam water and so on, it shall conform with the requirements in Technical Specifications MRTS10 *Plant-Mixed Lightly Bound Pavements*, Clause 6.5 *Water quality* or MRTS08 *Plant-Mixed Heavily Bound (Cemented) Pavements*, Clause 6.5 *Water quality*.

#### 4.4.4 UCS test analysis

The UCS testing for the mix design is undertaken in accordance with Technical Specification MRTS08 *Plant-Mixed Heavily Bound (Cemented) Pavements*, Clause 7 *Mix design* or MRTS10 *Plant Mixed Lightly Bound Pavements*, Clause 7 *Mix design*. The testing involves the

compaction of at least three test portions (minimum three specimens at each) at a range of cement contents. Where an upper and lower UCS limit applies, such as lightly bound materials, then the range of cement contents should straddle this range and have one portion below the minimum limit and one portion above the maximum limit. Compact additional portions, if required, to straddle the required range. The user of the data must be able to interpolate and not extrapolate.

There is a significant influence by density of the strength of all compacted soil. A 1% reduction in relative compaction can reduce the UCS by 5%. Small density variations can easily mask the effects of other variables such as cement content and curing conditions.

Since compacted density has a direct influence on UCS, variation in compaction moisture must be limited. Suggested limits for achieved moisture content are:

$$\text{Achieved moisture content} = \text{target moisture content} \pm 0.3 \text{ percentile units}$$

Condition the cement / soil mixture using short-term conditioning; that is, the cement / soil mixture is to condition in an airtight container for 45 minutes before further mixing and compaction.

A standard curing regime comprising moist curing at  $23 \pm 2^\circ\text{C}$  for 28 days for heavily bound material and seven and 28 days for lightly bound material has been adopted in accordance with Test Method Q135B.

All specimens are to be tested using the standard UCS Test Method Q115.

#### 4.4.5 Allowable working time

The AWT for cement stabilised materials is four hours in accordance with Technical Specification MRTS08 *Plant-Mixed Heavily Bound (Cemented) Pavements*, Clause 8.2.3 *Allowable working time* or MRTS10 *Plant-Mixed Lightly Bound Pavements*, Clause 8.2.3 *Allowable working time*.

#### 4.5 Production testing – compliance

Undertake production testing to ensure that specification requirements, such as cement content and UCS are in compliance using the test methods in Table 4.5.

**Table 4.5 – Test methods used for compliance**

Property	Test Method	Title
Cement content	Q134	Stabilising agent content – heat of neutralisation
MDD / OMC	Q142A	Dry density-moisture relationship (standard compaction)
	Q144A	Assignment of MDD and optimum moisture content for soils and crushed rock
UCS	Q115	UCS of compacted materials
	Q251B	Preparation and compaction of field mixed stabilised materials
	Q135B	Curing of moulded specimens of stabilised materials

##### 4.5.1 Cement content

For plant-mixed stabilisation, the Heat of Neutralisation test is a rapid low-cost field test. Samples of both the un-stabilised material and the stabilising agent are required prior to performing this test.

#### 4.5.2 MDD / OMC

The plant-mixed stabilised materials are uniform, which allows the use of testing regime using an assigned MDD / OMC. Such testing involves taking a sample from the quarry stockpile and adding the target additive content to the materials and determining a MDD / OMC. An initial value based on the mean of six tests is used. This is then updated every 10 000 tonnes using one new test and calculating a rolling mean.

#### 4.5.3 Production UCS

The UCS test is a compliance test for plant-mixed materials. Use the MDD / OMC results for the material to determine the wet mass per layer using the process in accordance with Test Method Q145A. Mould the material at the 'as produced' moisture content using standard compaction effort. Cure the moulded specimens under standard conditions prior to testing.

#### 4.6 Field testing – compliance

Undertake field testing to ensure that specification requirements, such as relative compaction, are in compliance using the test methods in Table 4.6.

**Table 4.6 – Test methods used for compliance**

Property	Test Method	Title
Compacted density	Q141A	Compacted density of soils and crushed rock (nuclear gauge)
	Q141B	Compacted density of soils and crushed rock (sand replacement)
Relative Compaction	Q140A	Relative compaction of soils and crushed rock

##### 4.6.1 Compacted density

Use nuclear gauge technique for cement modified / stabilised materials provided a wet density and moisture content bias is determined in accordance with the *Nuclear Gauge Testing Manual*. Use of the sand replacement test for measuring insitu density is an alternative, but it is more destructive to the finished pavement.

## 5 Testing of materials for insitu foamed bitumen stabilisation

### 5.1 Introduction

This section outlines the process for:

- a) sampling and characterising host soil
- b) design procedure to determine the properties of material stabilised with foamed bitumen and a secondary stabilising agent, and
- c) measuring the properties of foamed bitumen stabilised materials in the field.

This section supports the application of the following departmental documents:

- MRTS07C *Insitu Stabilised Pavements using Foamed Bitumen*, and
- *Pavement Rehabilitation Manual*, Clause 4.9.8.

## 5.2 Background

In situ foamed bitumen stabilisation is a mobile process of mixing bitumen (in a foamed state), the primary stabilising agent, and a secondary stabilising agent, usually hydrated lime, into pavement materials, with the intention of improving the strength and moisture resistance of the existing un-stabilised material(s). The purpose of the bitumen (in conjunction with the secondary stabilising agent) is to achieve a strong yet flexible pavement layer compared to other stabilisation treatments, such as those using cement.

The aim is to provide a material that:

- has enough strength for early trafficking, assessed using minimum initial modulus
- is strong and flexible, assessed using minimum three day cured modulus, and
- is able to withstand inundation, assessed using minimum three day soaked modulus and minimum retained modulus.

The summary of the categories and characteristics of the various types of stabilised materials typically adopted by Transport and Main Roads are shown in the *Guide to Pavement Technology Part 4D: Stabilised Materials*, Austroads, Table 2.1.

The design limits for in situ stabilised materials are shown in the *Pavement Rehabilitation Manual*, Transport and Main Roads in Tables 4.9.8.5.1(a), 4.9.8.5.1(b) and 4.9.8.5.1(c).

## 5.3 Sampling and characterisation

Sample the section under consideration at appropriate intervals to identify material properties and uniformity using the sampling methods in Table 5.3. Use of a soil classification system such as the unified soils classification system can assist in identifying the soil types.

For characterisation, bulk samples of 10–50kg will be required, depending on the maximum particle size of the material. For mix design, an additional bulk sample of 70–90kg will be required.

It may be necessary to sample the pavement in a manner that simulates both the mixing and the disruption caused by using up to three passes of a stabiliser. A bobcat or excavator fitted with a profiling / milling head can simulate this mixing. Mill a lateral trench using three passes retaining all the material for the sample. Do not test this material as part of the characterisation of the pavement; retain this material for the mix design in Section 5.4.

Do not sample materials excluded from the works during construction, such as sprayed surfacing, asphalt or stabilised patches. Before commencing any sampling, obtain clarification sampling of materials.

Sample any material to be imported to add to the pavement for in situ stabilisation at its source, usually a quarry, to obtain a representative sample of the material.

**Table 5.3 – Test methods used to sample materials**

Property	Test Method	Title
Sampling – machine excavated pit or trench	AS 1289.1.2.1	Sampling and preparation of soils – disturbed samples
Sampling from stockpile	AS 1141.3.1	Sampling - Aggregates
Sampling for stabilisation testing – plant excavation	Q061	Spot sampling of soils, crushed rock and aggregates

### 5.3.1 Classification

Undertake particle size distribution and Atterberg limits testing using test methods listed in Table 5.3.1 on the samples. Use the results of particle size distribution, Atterberg limits and visual classification to classify the material sampled and to gain a preliminary assessment of the type of stabilisation suitable samples tested. Refer to *Guide to Pavement Technology Part 4D: Stabilised Materials*, Austroads, Table 2.4 for details. These results are also used to select representative samples for further testing.

Additional requirements for materials that are suitable for stabilisation are detailed in the *Pavement Rehabilitation Manual*, Clause 4.9.8.4.1 *Suitability of materials to be stabilised – general*.

**Table 5.3.1 – Test methods used to classify materials**

Property	Test Method	Title
Particle Size Distribution (Grading)	Q103A	Particle size distribution of soil – wet sieving
Atterberg limits (Liquid limit, plastic limit, plasticity index and linear shrinkage)	Q104A or D	Liquid limit of soil
	Q105	Plastic limit and plasticity index of soil
	Q106	Linear shrinkage of soil

### 5.3.2 Deleterious materials

This is usually not an issue for materials obtained from quarries or existing pavement materials originally obtained from quarries; however, materials need to be free of organic or other deleterious materials. The water-soluble sulfate content must not exceed 1.9g of sulfate (expressed as SO<sub>3</sub>) per litre.

Use the test methods in Table 5.3.2 to identify deleterious materials.

**Table 5.3.2 – Test methods used to identify deleterious materials**

Property	Test Method	Title
Organic content	Q120B	Organic content of soil – loss on ignition
Sulfate content	AS 1289.4.2.1	Determination of the sulfate content of a natural soil and the sulfate content of the groundwater

## 5.4 Mix design

This stage of the procedure is to establish the suitability of stabilising the host material with foamed bitumen. Perform this with samples prepared at 70% OMC, with 3.0% bitumen and 2.0% lime. If the host material is suitable it may, for larger projects, be appropriate to perform further testing to optimise the bitumen and lime contents.

Use the design test methods in Table 5.4.



**Table 5.4 – Test methods used for design**

Property	Test Method	Title
Resilient modulus	Q139	Resilient modulus of stabilised material – indirect tensile method
	Q138A	Preparation and compaction of laboratory mixed foamed bitumen stabilised material
	Q138B	Preparation and compaction of field mixed foamed bitumen stabilised material
	Q254B	Curing moulded specimens of foamed bitumen stabilised material
Compacted density and moisture content	Q147B	Compacted density of stabilised material – vacuum saturation
Optimum moisture content	Q142A	Dry density-moisture relationship (standard compaction)
Available lime	AS 4489.6.1	Lime index – available lime
Dynamic viscosity	AS/NZS 2341.2	Determination of dynamic (coefficient of shear) viscosity by flow through a capillary tube
Sulfate content of groundwater	AS 1289.4.2.1	Determination of the sulfate content of a natural soil and the sulfate content of the groundwater
Expansion ratio and half-life	AG:PT/T301	Determining the foaming characteristics of bitumen

#### 5.4.1 Lime

Hydrated lime, conforming to the requirements of Technical Specification MRTS23 *Supply and Delivery of Quicklime and Hydrated Lime for Road Stabilisation*, is to be used exclusively in laboratory testing. Source the hydrated lime directly from suppliers. Do not use bagged supplies from hardware stores / building suppliers, as the age and condition of the lime is unknown. Instructions for the storage and use of lime are included in Section 8.

Obtain a certificate with the ALI ( $AL_x$ ) from the supplier for the batch of lime. As an alternative, sample the lime and forward the sample to a laboratory to determine the ALI. Forward the ALI certificate, along with other results of testing for the mix design procedure. This allows the lime content to be adjusted for a different quality of lime in accordance with Technical Specification MRTS07C *In situ Stabilised Pavements using Foamed Bitumen*, Clause 6.3 *Stabilising agents*.

Do not use quicklime in the laboratory because of safety concerns, and the need to exercise very tight control over moisture during moulding. If complete hydration of the quicklime does not occur before compaction, carbonation and localised expansion can occur.

#### 5.4.2 Supplementary cementitious materials

Source supplementary cementitious materials (fly ash, slag, silica fume and so on) directly from suppliers and keep dry in airtight containers. Instructions for the storage and use of supplementary cementitious materials are included in Section 8

### **5.4.3 Bitumen**

Use Class 170 bitumen for all foamed bitumen designs. Check each batch of bitumen for viscosity before use. A sample of the batch should be foamed, and the foaming apparatus adjusted to provide expansion ratio of at least 10 and a half-life of at least 20 seconds. This will usually require a foaming water content of 3.0%; however, this should be optimised for each batch of bitumen. A foaming additive (satisfactory performance has been observed by Inter-foam and Terric 311) may be required to foam the bitumen, additional foaming trials will be required to determine the optimum addition rate for the foaming additive.

### **5.4.4 Water**

Where other water is used, such as site water, dam water and so on, it shall conform with the requirements in Technical Specification MRTS07C *In situ Stabilised Pavements using Foamed Bitumen*, Clause 6.4 *Water*.

### **5.4.5 Imported material**

Where imported material is required, use material conforming to the requirements of Technical Specification MRTS05 *Unbound Pavements* in laboratory testing. Source the material directly from the nominated quarry. Add the imported material to the representative samples for the resilient modulus testing in proportions nominated by the designer.

### **5.4.6 Resilient modulus**

The resilient modulus is determined by performing a resilient modulus test on a minimum of three specimens prepared at a single bitumen and lime content. These are usually prepared at 70% OMC, with 3.0% bitumen content and lime content between 1.5–2.0% in accordance with Test Method Q138A.

A standard curing and testing regime is undertaken in accordance with Test Method Q254B and the specimens are then tested in accordance with Test Method Q139 to determine the initial modulus, three day cured modulus and three day soaked modulus. The compacted density and moisture content of the specimens may be determined in accordance with Test Method Q147B.

### **5.4.7 Analysis**

If the results obtained from the resilient modulus testing conform with the specific design limits from the *Pavement Rehabilitation Manual* Tables 4.9.8.4.1(a), 4.9.8.5.1(b) and 4.9.8.5.1(c), then the host material can be stabilised using the moisture condition, bitumen content and lime content from Section 5.4.6.

### **5.4.8 Optimisation**

For large projects, it may be worthwhile to conduct further design testings, varying the bitumen and lime contents to optimise bitumen and lime contents.

### **5.4.9 Allowable working time**

The AWT for insitu stabilised materials is 6.5 hours in accordance with Technical Specification MRTS07C *In situ Stabilised Pavements using Foamed Bitumen*, Clause 8.4 *Allowable working time* unless specified in the annexure to this Technical Specification.

## 5.5 Field testing – compliance

Undertake production testing to ensure compliance with the specification for properties such as bitumen content, hydrated lime content and relative moisture ratio using the test methods in Table 5.5.

**Table 5.5 – Test methods used for compliance**

Property	Test Method	Title
Spread rate	Q719	Field spread rate of solid stabilising agents – fabric mat
Bitumen content	Q118	Bitumen content of stabilised material
Compacted density	Q141A	Compacted density of soils and crushed rock (nuclear gauge)
	Q141B	Compacted density of soils and crushed rock (sand replacement)
MDD / OMC	Q142A	Dry density – moisture relationship (standard compaction)
	Q144A	Assignment of MDD and optimum moisture content for soils and crushed rock
Relative Compaction	Q140A	Relative compaction of soils and crushed rock

### 5.5.1 Lime content

For insitu stabilisation, a simple mat test is used to measure stabilising agent spread rate. Place one or more 1m<sup>2</sup> mats to catch the discharge from the spreader.

### 5.5.2 Bitumen content

Measure the bitumen content using a solvent extraction method. Normally the testing is performed in a specialised laboratory.

### 5.5.3 Compacted density and MDD / OMC

Use nuclear gauge technique for cement modified / stabilised materials provided a wet density and moisture content bias is determined in accordance with the *Nuclear Gauge Testing Manual*. Use of the sand replacement test for measuring insitu density is an alternative, but it is more destructive to the finished pavement.

Measure the MDD / OMC using the traditional dry density-moisture relationship test. Complete the sampling and compaction of the MDD / OMC sample before the AWT for the material has elapsed. A project / material specific AWT is determined for each project.

The inherent variability of insitu stabilised materials usually means the employment of a testing regime of one-for-one testing. Such testing involves taking a sample from each insitu density location and determining an MDD / OMC.

### 5.5.4 Moisture content of stabilised material

Monitoring and adjustment of the moisture content of the stabilised material is critical to the performance of the finished pavement.

The moisture ratio of the stabilised material after the final wet incorporation pass but before compaction, should be in the range specified in accordance with Technical Specification MRTS07C *Insitu Stabilised Pavements using Foamed Bitumen*, Clause 8.8 *Product standards*.

As a minimum frequency, the relative moisture ratio of stabilised materials is assessed at each test location for compaction tests.

### 5.5.5 Field testing - verification

Undertake testing to verify the design parameters, such as resilient modulus are acceptable, and where necessary fine-tune the design and production processes using the test methods in Table 5.6.

**Table 5.5.5 – Test methods used for verification**

Property	Test Method	Title
Resilient modulus	Q139	Resilient modulus of stabilised material – indirect tensile method
	Q138B	Preparation and compaction of field mixed foamed bitumen stabilised material
	Q254B	Curing moulded specimens of foamed bitumen stabilised material
Compacted density and moisture content	Q147B	Compacted density of stabilised material – vacuum saturation

### 5.5.6 Field modulus

The resilient modulus test provides additional information on expected field performance relative to design. Mould the field mixed material at field moisture content in accordance with Test Method Q138B. Cure the moulded specimens under standard conditions prior to testing in accordance with Test Method Q254B. Test the specimens in accordance with Test Method Q139 to determine the initial modulus, three day cured modulus and three day soaked modulus. The compacted density and moisture content of the specimens may be determined in accordance with Test Method Q147B.

When sampling and making resilient modulus specimens in the field, assume the insitu moisture content will be close to the target moisture content of the material. If not, then the achieved dry density and dry density ratio will vary from the design; therefore, care is required in interpreting these results.

## 6 Testing of materials for plant-mixed foamed bitumen stabilisation

### 6.1 Introduction

This section outlines the process for:

- a) sampling and characterising host soil
- b) design procedure to determine the properties of material stabilised with foamed bitumen and a secondary stabilising agent, and
- c) measuring the properties of foamed bitumen stabilised materials at the production plant and in the field.

This section supports the application of the following departmental documents:

- MRTS09 *Plant-Mixed Pavement Layers Stabilised using Foamed Bitumen*.

### 6.2 Background

Plant-mixed foamed bitumen stabilisation involves stationary pugmill mixing of bitumen (in a foamed state), the primary stabilising agent, and a secondary stabilising agent, usually hydrated lime, into

pavement materials, with the intention of improving the strength and moisture resistance of the existing un-stabilised material(s). The purpose of the bitumen (in conjunction with the secondary stabilising agent) is to achieve a strong yet flexible pavement layer compared to other stabilisation treatments, such as those using cement.

The aim is to provide a material that:

- has enough strength for early trafficking, assessed using minimum initial modulus
- is strong and flexible, assessed using minimum three day cured modulus, and
- is able to withstand inundation, assessed using minimum three day soaked modulus and minimum retained modulus.

The summary of the categories and characteristics of the various types of stabilised materials typically adopted by Transport and Main Roads are shown in the *Guide to Pavement Technology Part 4D: Stabilised Materials*, Austroads, Table 2.1.

### 6.2.1 Laboratory trial

A laboratory trial must be undertaken as specified in Technical Specification MRTS09 *Plant-Mixed Pavement Layers Stabilised using Foamed Bitumen*, Clause 7.4.1, with the stabilised materials conforming to the requirements in Tables 5.2.2(a) and 5.2.2(b) of the Technical Specification.

### 6.2.2 Plant production trial

The nominated mix from Section 6.2.1 is then produced at the proposed production plant and sampled and tested as specified in Technical Specification MRTS09 *Plant-Mixed Pavement Layers Stabilised using Foamed Bitumen*, Clause 7.4.2, with produced material conforming to the requirements in Table 5.2.2(b) of the Technical Specification.

## 6.3 Sampling and characterisation

Sample the section under consideration at regular intervals to identify material types and changes within any material using the sampling methods listed in Table 6.3. For characterisation, bulk samples of 10–50kg will be required, depending on the maximum particle size of the material. For mix designs, an additional bulk sample of 70–90kg will be required.

For plant-mixed stabilisation, sample the material at its source, usually a quarry, to obtain a representative sample of the material to be used.

**Table 6.3 – Test methods used to sample materials**

Property	Test Method	Title
Sampling – machine excavated pit or trench	AS 1289.1.2.1	Sampling and preparation of soils – disturbed samples
Sampling from stockpile	AS 1141.3.1	Sampling - Aggregates

### 6.3.1 Classification

Undertake particle size distribution and Atterberg limits testing using test methods listed in Table 6.3.1 on the samples. Use the results of particle size distribution, Atterberg limits and visual classification to classify the material sampled and to gain a preliminary assessment of the type of stabilisation suitable samples tested. Refer to *Guide to Pavement Technology Part 4D: Stabilised Materials*, Austroads, Table 2.4 for details. These results are also used to select representative samples for further testing.

Additional requirements for materials are detailed in Technical Specification MRTS09 *Plant-Mixed Pavement Layers Stabilised using Foamed Bitumen*, Clause 6.1 *Materials to be stabilised*.

**Table 6.3.1 – Test methods used to classify materials**

Property	Test Method	Title
Particle Size Distribution (Grading)	Q103A	Particle size distribution of soil – wet sieving
Atterberg limits (Liquid limit, plastic limit, plasticity index and linear shrinkage)	Q104A or D	Liquid limit of soil
	Q105	Plastic limit and plasticity index of soil
	Q106	Linear shrinkage of soil

### 6.3.2 Deleterious materials

This is usually not an issue for materials obtained from quarries. The water-soluble sulfate content must not exceed 1.9g of sulfate (expressed as SO<sub>3</sub>) per litre.

Use the test method in Table 6.3.2 to identify deleterious materials.

**Table 6.3.2 – Test methods used to identify deleterious material**

Property	Test Method	Title
Sulfate content	AS 1289.4.2.1	Determination of the sulfate content of a natural soil and the sulfate content of the groundwater

### 6.4 Mix design

This stage of the procedure is to establish the suitability of stabilising the host material with foamed bitumen. Perform this with samples prepared at 70% OMC, with 3.0% bitumen and 2.0% lime. If the host material is suitable it may, for larger projects, be appropriate to perform further testing to optimise the bitumen and lime contents. Use the design test methods in Table 6.4.

**Table 6.4 – Test methods used for design**

Property	Test Method	Title
Resilient modulus	Q139	Resilient modulus of stabilised material – indirect tensile method
	Q138A	Preparation and compaction of laboratory mixed foamed bitumen stabilised material
	Q138B	Preparation and compaction of field mixed foamed bitumen stabilised material
	Q254B	Curing moulded specimens of foamed bitumen stabilised material
Compacted density and moisture content	Q147B	Compacted density of stabilised material – vacuum saturation
Optimum moisture content	Q142A	Dry density-moisture relationship (standard compaction)
ALI	AS 4489.6.1	Lime index – available lime
Dynamic viscosity	AS/NZS 2341.2	Determination of dynamic (coefficient of shear) viscosity by flow through a capillary tube

Property	Test Method	Title
Sulfate content of groundwater	AS 1289.4.2.1	Determination of the sulfate content of a natural soil and the sulfate content of the groundwater
Expansion ratio and half-life	AG:PT/T301	Determining the foaming characteristics of bitumen
AWT	Q136B	Working time of foamed bitumen stabilised materials

#### 6.4.1 Lime

Hydrated lime, conforming to the requirements of Technical Specification MRTS23 *Supply and Delivery of Quicklime and Hydrated Lime for Road Stabilisation*, is to be used exclusively in laboratory testing. Source the hydrated lime directly from suppliers. Do not use bagged supplies from hardware stores / building suppliers, as the age and condition of the lime is unknown. Instructions for the storage and use of lime are included in Section 8.

Obtain a certificate with the ALI ( $AL_x$ ) from the supplier for the batch of lime. As an alternative, sample the lime and forward the sample to a laboratory to determine the ALI. Forward the ALI certificate, along with other results of testing for the mix design procedure. This allows the lime content to be adjusted for a different quality of lime in accordance with Technical Specification MRTS09 *Plant-Mixed Pavement Layers Stabilised using Foamed Bitumen*, Clause 6.2 *Stabilising agents*.

Do not use quicklime in the laboratory because of safety concerns, and the need to exercise very tight control over moisture during moulding. If complete hydration of the quicklime does not occur before compaction, carbonation and localised expansion can occur.

#### 6.4.2 Supplementary cementitious materials

Source supplementary cementitious materials (fly ash, slag, silica fume and so on) directly from suppliers and keep dry in airtight containers. Instructions for the storage and use of supplementary cementitious materials are included in Section 8

#### 6.4.3 Bitumen

Use Class 170 bitumen for all foamed bitumen designs. Check each batch of bitumen for viscosity before use. A sample of the batch should be foamed and the foaming apparatus adjusted to provide expansion ratio of at least 10 and a half-life of at least 20 seconds. This will usually require a foaming water content of 3.0%; however, this should be optimised for each batch of bitumen. A foaming additive (satisfactory performance has been observed by Inter-foam and Terric 311) may be required to foam the bitumen; additional foaming trials will be required to determine the optimum addition rate for the foaming additive.

#### 6.4.4 Water

Where other water is used, such as site water, dam water and so on, it shall conform with the requirements in Technical Specification MRTS09 *Plant-Mixed Pavement Layers Stabilised using Foamed Bitumen*, Clause 6.3 *Water*.

#### **6.4.5 Resilient modulus**

The resilient modulus is determined by performing a resilient modulus test on a minimum of three specimens prepared at a single bitumen and lime content. These are usually prepared at 70% OMC, with 3.0% bitumen content and lime content between 1.5–2.0% in accordance with Test Method Q138A.

A standard curing and testing regime is undertaken in accordance with Test Method Q254B and the specimens are then tested in accordance with Test Method Q139 to determine the initial modulus, three day cured modulus and three day soaked modulus. The compacted density and moisture content of the specimens may be determined in accordance with Test Method Q147B.

#### **6.4.6 Analysis**

If the results obtained from the resilient modulus testing conform with the requirements of the *Guide to Pavement Technology Part 4D: Stabilised Materials*, Austroads in Table 5.9, then the host material can be stabilised using the moisture condition, bitumen content and lime content from Section 6.4.5.

#### **6.4.7 Optimisation**

For large projects, it may be worthwhile to adjust the bitumen and lime contents to find an optimal bitumen / lime content.

#### **6.4.8 Allowable working time**

The AWT for plant-mixed materials is nominated as eight hours in accordance with Technical Specification MRTS09 *Plant-Mixed Pavement Layers Stabilised using Foamed Bitumen*, Clause 8.6 *Allowable working time* unless specified in the annexure to this Technical Specification.

Working time testing may be undertaken by the Contractor to determine if the AWT for the Contractor's approved plant mixed foamed bitumen stabilised materials can be extended beyond the limit of eight hours. Testing to determine the working time limit is undertaken using Test Method Q136B.

The working time limit is then defined as the lesser of the following values:

- the delay time that produces a 20% reduction in achieved reference three day soaked modulus (that is, 100% to 80%), or
- the delay time that achieves the three day soaked modulus value that is equal to the modulus adopted in the pavement design (typically 1800 MPa).

The AWT may be extended beyond the specified eight hours, provided there are supporting Q136B testing data with AWT not to exceed 16 hours.

### **6.5 Production testing – compliance**

Undertake product testing to ensure compliance with the specification for properties such as bitumen content, hydrated lime content and relative moisture ratio using the test methods in Table 6.5.



**Table 6.5 – Test methods used for production compliance**

Property	Test Method	Title
MDD / OMC	Q142A	Dry density-moisture relationship (standard compaction)
	Q144A	Assignment of MDD and optimum moisture content for soils and crushed rock
Relative moisture ratio	Q250	Relative moisture content of soils and crushed rock

### 6.5.1 Lime content

For plant-mixed materials, the lime content is controlled using load cells on the lime bins to measure the amount of lime added to the material.

### 6.5.2 Bitumen content

For plant-mixed materials, control of the bitumen content using flow meters to measure the amount of bitumen added to the material is allowed in the Technical Specification.

### 6.5.3 Moisture content of feed stockpile and stabilised material

Monitoring and adjustment of the moisture content of the feed stockpiles and stabilised material stockpiles is critical to the performance of the final pavement.

The relative moisture ratio of the feed stockpile and stabilised material stockpile should be in the range specified in accordance with Technical Specification MRTS09 *Plant-Mixed Pavement Layers Stabilised using Foamed Bitumen*, Clause 8.9.6 *Relative Moisture Ratio of Feed Stockpiles (RMR FSP)* or Clause 9.8 *Relative Moisture Ratio Foamed Bitumen (RMR FB)* respectively.

### 6.5.4 MDD / OMC

Measure the MDD / OMC using the traditional dry density-moisture relationship test. Complete the sampling and compaction of the MDD / OMC sample before the AWT for the material has elapsed.

The plant-mixed stabilised materials are uniform, which allows the use of testing regime using an assigned MDD / OMC. Such testing involves taking a sample from the quarry stockpile and adding the target additive content to the materials and determining an MDD / OMC. An initial value based on the mean of six tests is used. This is then updated every 10 000 tonnes using one new test and calculating a rolling mean.

If this is not possible, employ a testing regime of one-for-one testing. Such testing involves taking a sample of uncompacted material from each insitu density location and determining an MDD / OMC.

## 6.6 Production testing – verification

Undertake testing to verify the design parameters such as resilient modulus are acceptable, and where necessary fine-tune the design and production processes using the test methods in Table 6.6.

**Table 6.6 – Test methods used for verification**

Property	Test Method	Title
Resilient modulus	Q139	Resilient modulus of stabilised material – indirect tensile method
	Q138B	Preparation and compaction of field mixed foamed bitumen stabilised material
	Q254B	Curing moulded specimens of foamed bitumen stabilised material
Compacted density and moisture content	Q147B	Compacted density of stabilised material – vacuum saturation

### 6.6.1 Field modulus

The resilient modulus test provides additional information on expected field performance relative to design. Mould the field mixed material at field moisture content in accordance with Test Method Q138B. Cure the moulded specimens under standard conditions prior to testing in accordance with Test Method Q254B. Test the specimens in accordance with Test Method Q139 to determine the initial modulus, three day cured modulus, three day soaked modulus, seven day cured modulus, seven day soaked modulus, 14 day cured modulus and 14 day soaked modulus. The compacted density and moisture content of the specimens may be determined in accordance with Test Method Q147B.

When sampling and making resilient modulus specimens in the field, assume the insitu moisture content will be close to the target moisture content of the material. If not, then the achieved dry density and dry density ratio will vary from the design; therefore, care is required in interpreting these results.

### 6.7 Field testing – compliance

Undertake field testing to ensure compliance with the specification for properties such as relative moisture ratio and relative compaction are achieved using the test methods in Table 6.7.

**Table 6.7 – Test methods used for compliance**

Property	Test Method	Title
Compacted density	Q141A	Compacted density of soils and crushed rock (nuclear gauge)
	Q141B	Compacted density of soils and crushed rock (sand replacement)
Relative Compaction	Q140A	Relative compaction of soils and crushed rock

#### 6.7.1 Compacted density and MDD / OMC

Use nuclear gauge technique for cement modified / stabilised materials provided a wet density and moisture content bias is determined in accordance with the *Nuclear Gauge Testing Manual*. Use of the sand replacement test for measuring insitu density is an alternative, but it is more destructive to the finished pavement.

## **7 Testing of materials for lime stabilisation**

### **7.1 Introduction**

This section outlines the process for:

- a) sampling and characterising host soil
- b) design procedure to determine the relationship between unconfined compressive strength and stabilising agent content, and
- c) measuring the properties of lime treated materials in the field.

This section supports the application of the following departmental documents:

- MRTS07A *Insitu Stabilised Subgrades using Quicklime or Hydrated Lime*
- MRTS23 *Supply and Delivery of Quicklime and Hydrated Lime for Road Stabilisation*, and
- *Pavement Rehabilitation Manual*, Section 4.9.7.

### **7.2 Background**

Insitu treatment of clay subgrades is a mobile process, during which lime, which has been either previously hydrated or hydrated on site by adding water (slaking) into a subgrade, is mixed with a purpose-designed road recycler to increase subgrade strengths. This may be done to modify the subgrade (that is, usually achieve a temporary strength gain) or it may be added to stabilise it (that is, achieve a permanent increase in strength). In the case of the latter, sufficient lime must be added to ensure that these strength gains are permanent.

The summary of the categories and characteristics of the various types of stabilised materials typically adopted by Transport and Main Roads are shown in the *Guide to Pavement Technology Part 4D: Stabilised Materials*, Austroads, Table 2.1.

For modification, the changes to soil properties result from an initial ionic exchange that results in flocculation of the clay particles. Modification occurs with addition of relatively low amounts of lime to a soil. This will have a dramatic effect on the soil and improve workability and increased shear strength. It will, however, increase the permeability of the soil.

For stabilisation, adding increased amounts of lime produces a pozzolanic reaction between the silica and alumina in the clay minerals and the calcium hydroxide in the lime. Permanent and ongoing reactions occur when sufficient lime is added: these reactions produce a flexible layer with decreased permeability and a significant increase in shear strength.

For further details, refer to Section 4.9.7 of the *Pavement Rehabilitation Manual*.

### **7.3 Sampling and characterisation**

Sample the section under consideration at appropriate intervals to identify material properties and uniformity using the sampling methods in Table 7.3. Use of a soil classification system such as the unified soils classification system can assist in identifying the soil types.

For characterisation, bulk samples of 10–50kg will be required, depending on the maximum particle size of the material. For mix design, an additional bulk sample of 70–90kg will be required.

**Table 7.3 – Test methods used to sample materials**

Property	Test Method	Title
Sampling – machine excavated pit or trench	AS 1289.1.2.1	Sampling and preparation of soils – disturbed samples

### 7.3.1 Classification

Undertake particle size distribution and Atterberg limits testing using test methods listed in Table 7.3.1 on the samples. Use the results of particle size distribution, Atterberg limits and visual classification to classify the material sampled and to gain a preliminary assessment of the type of stabilisation suitable samples tested. Refer to *Guide to Pavement Technology Part 4D: Stabilised Materials*, Austroads, Table 2.4 for details. These results are also used to select representative samples for further testing.

Refer to *Pavement Rehabilitation Manual*, Section 4.9.7 and Technical Specification MRTS07A *In situ Stabilised Subgrades using Quicklime or Hydrated Lime*, Clause 8.7.2 *Removal and disposal of material not suitable for stabilisation* for more details.

**Table 7.3.1 – Test methods used to classify materials**

Property	Test Method	Title
Particle Size Distribution (Grading)	AS 1289.3.6.1	Particle size distribution of soil – wet sieving
	AS 1289.3.6.3	Particle size distribution of soil – hydrometer
Atterberg limits (Liquid limit, plastic limit, plasticity index and linear shrinkage)	AS 1289.3.1.1 or 3.1.2	Liquid limit of soil
	AS 1289.3.2.1 and 3.3.1	Plastic limit and plasticity index of soil
	AS 1289.3.4.1	Linear shrinkage of soil

### 7.3.2 Deleterious materials

Testing for deleterious materials includes the determination of sulfate, organic content and ferrous oxide contents using the test methods listed in Table 7.3.2. Organic matter interferes with the hydration process as well as competing for available stabilising agent – water paste. Sulfates can also interfere with pozzolanic reactions due to the formation of very expansive hydrates which, if formed, after compaction and can result in heave. Ferrous oxide can also interfere with pozzolanic reactions.

Materials must not exceed the deleterious materials limits shown in MRTS07A *In situ Stabilised Subgrades using Quicklime or Hydrated Lime*, Table 6.1 *Deleterious material limits*.

Additionally, any new material incorporated into the works shall not have deleterious materials exceeding the limits specified in Technical Specification MRTS07A *In situ Stabilised Subgrades using Quicklime or Hydrated Lime*, Clause 6.1 *New material to replace material not suitable for stabilisation*.

**Table 7.3.2 – Test methods used to identify deleterious materials**

Property	Test Method	Title
Organic content	Q120B	Organic content of soil – loss on ignition
Sulfate content	AS 1289.4.2.1	Determination of the sulfate content of a natural soil and the sulfate content of the groundwater
Ferrous oxide (FeO)	In-house*	Determination of ferrous iron by acid digestion

\* Private analytical laboratories will use in-house methods based on classical techniques.

#### 7.4 Mix design procedure

This procedure is used to establish the reactivity of the host soil with lime and to establish whether pozzolanic reactions will occur to produce substantial strength. It is essential that long-term pozzolanic bonds are formed and that the resulting soil matrix is sufficiently coherent to ensure long-term durability. A densely bonded matrix is less susceptible to moisture, and has improved resistance to carbonation, leaching of lime or erosion.

Use the design test methods in Table 7.4.

**Table 7.4 – Test methods used for design**

Property	Test method	Title
Lime demand	Q133	Lime demand of soil
UCS	Q115	UCS of stabilised materials
	Q251A	Preparation and compaction of laboratory mixed stabilised materials
	Q251C	Preparation and compaction of soils
	Q135A	Addition of stabilising agents
	Q135B	Curing of moulded specimens of stabilised materials
Capillary rise	Q125D	Capillary rise of stabilised material
ALI	AS 4489.6.1	Lime index – available lime

##### 7.4.1 Lime

Where required hydrated lime, conforming to the requirements of Technical Specification MRTS23 *Supply and Delivery of Quicklime and Hydrated Lime for Road Stabilisation*, is to be used exclusively in laboratory testing. Source the hydrated lime directly from suppliers. Do not use bagged supplies from hardware stores / building suppliers, as the age and condition of the lime is unknown. Instructions for the storage and use of lime are included in Section 8.

Obtain a certificate with the ALI ( $AL_x$ ) from the supplier for the batch of lime. As an alternative, sample the lime and forward the sample to a laboratory to determine the ALI. Forward the ALI certificate, along with other results of testing for the mix design procedure. This allows the lime content to be adjusted for a different quality of lime in accordance with Technical Specification MRTS07A *In situ Stabilised Subgrades using Quicklime or Hydrated Lime*, Clause 6.2 *Stabilising agent*.

Do not use quicklime in the laboratory because of safety concerns, and the need to exercise very tight control over moisture during moulding. If complete hydration of the quicklime does not occur before compaction, carbonation and localised expansion can occur.

### 7.4.2 Water

Where other water is used, such as site water, dam water and so on, it shall conform with the requirements in Technical Specification MRTS07A *In situ Stabilised Subgrades using Quicklime or Hydrated Lime*, Clause 6.3 Water.

### 7.4.3 Lime demand

Measure the quantity of lime required to satisfy cation exchange and short-term reactions using the Lime Demand (LD) test. The lime demand is undertaken to obtain the minimum lime content and is not the target content for the design process. In Figure 7.4.3, the lime demand value as defined in Test Method Q133 is 4.0%.

**Figure 7.4.3 – Lime demand curve**

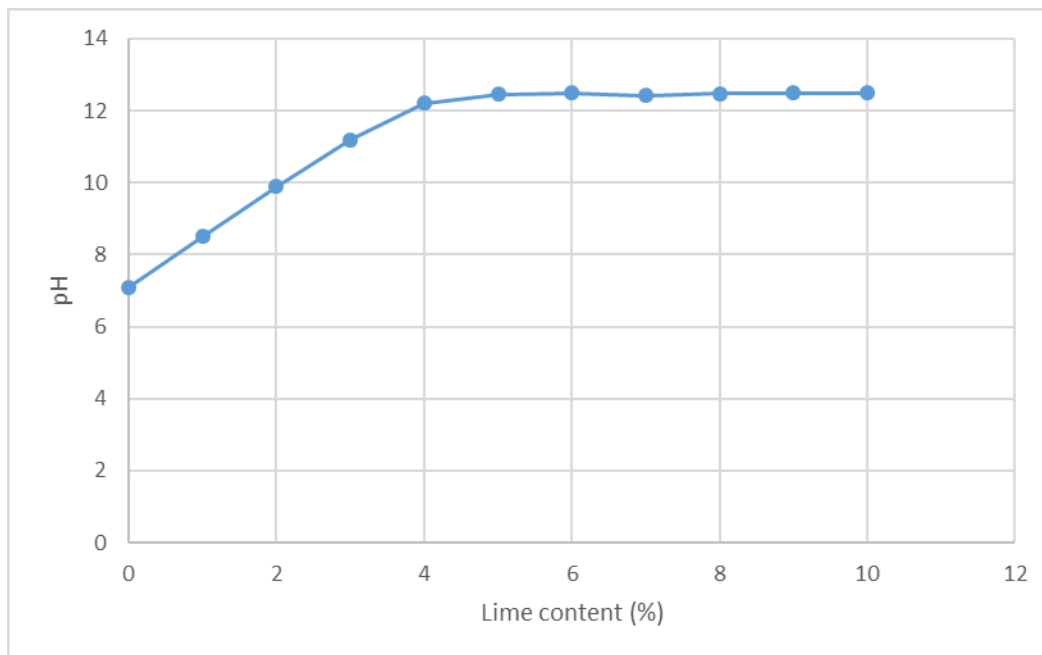

There should be a significant lime demand. Obtaining lime demands of 2.0–2.5% is possible with non-reactive materials (dry fine sand).

This test is a good starting point for determining the optimum lime content; however, it does not establish whether pozzolanic reactions will occur to produce long-term strength gains.

### 7.4.4 UCS

Use the UCS to assess the reactivity of the host soil and select a lime content, which will ensure long-term durability. Undertake UCS tests at a range of lime contents commencing with 0% lime. Suggested lime contents are:

*0, LD-2, LD, LD+2, and LD+4*

The target conditions for compaction of the UCS specimens will be 97% MDD and 100% OMC for subgrade materials. There is a significant influence by density of the strength of all compacted soil. A 1% reduction in relative compaction can reduce the UCS by 5%. Small density variations can easily mask the effects of other variables such as lime content and curing conditions.

Since compacted density has a direct influence on UCS, variation in compaction moisture must be limited. Suggested limits for achieved moisture content are:

$$\text{Achieved moisture content} = \text{target moisture content} \pm 0.3 \text{ percentile units}$$

A standard curing regime comprising moist curing at  $23 \pm 2^\circ\text{C}$  for 28 days has been adopted in accordance with Test Method Q135B.

The lime / soil mixture should be conditioned using long-term conditioning (amelioration); that is, where the lime / soil mixture is subjected to light compaction followed by overnight conditioning in an airtight container, followed by break-up, mixing and compaction.

All specimens are to be tested using the standard UCS Test Method Q115.

#### 7.4.5 Analysis

To establish the reactivity of the soil, compare the UCS at 0% lime to that of the lime demand content and assess it against the following criteria.

**Table 7.4.5 – Long term reactivity**

Condition	Reactive / Non-reactive
UCS at LD – UCS at 0% Lime	$\leq 0.35$ MPa non-reactive soil
UCS at LD – UCS at 0% Lime	$> 0.35$ MPa reactive soil

Non-reactive soils are generally not suitable for lime stabilisation. For reactive soils, plot the UCS data versus lime content and determine the lime content corresponding to a UCS of 1.5 MPa which will be the target stabilising agent (lime) content.

Where there is a range of lime contents corresponding to a UCS of 1.5 MPa, undertake capillary rise testing at LD+2 and LD+4. Use the lime content with the slowest capillary rise as the target stabilising agent (lime) content.

#### 7.4.6 Allowable working time

The AWT for lime-stabilised materials is 48 hours in accordance with Technical Specification MRTS07A *In situ Stabilised Subgrades using Quicklime or Hydrated Lime*, Clause 8.4 *Allowable working time* unless specified in the annexure to this Technical Specification.

#### 7.5 Field testing – compliance

Undertake field control testing to ensure the design parameters, such as lime content, relative compaction and unconfined compressive strength are achieved using the test methods in Table 7.5.

**Table 7.5 – Test methods used for compliance**

Property	Test method	Title
Spread rate	Q719	Field spread rate of solid stabilising agents – fabric mat
Compacted density	Q141A	Compacted density of soils and crushed rock (nuclear gauge)
	Q141B	Compacted density of soils and crushed rock (sand replacement)
MDD / OMC	Q142A	Dry density-moisture relationship (standard compaction)
Relative Compaction	Q140A	Relative compaction of soils and crushed rock
Relative moisture ratio	Q250	Relative moisture content of soils and crushed rock

### 7.5.1 Lime content

For insitu stabilisation, a simple mat test is used to measure stabilising agent spread rate. Place one or more 1m<sup>2</sup> mats to catch the discharge from the spreader. This test is suitable for both powdered lime and lime slurries.

### 7.5.2 Compacted density and MDD / OMC

Use nuclear gauge technique for cement modified / stabilised materials provided a wet density and moisture content bias is determined in accordance with the *Nuclear Gauge Testing Manual*. Use of the sand replacement test for measuring insitu density is an alternative, but it is more destructive to the finished surface.

Measure the MDD / OMC using the traditional dry density-moisture relationship test. Complete the sampling and compaction of the MDD / OMC sample before the AWT for the material has elapsed.

The inherent variability of insitu stabilised materials usually means the employment of a testing regime of one-for-one testing. Such testing involves taking a sample from each insitu density location and determining an MDD / OMC.

### 7.5.3 Moisture content of stabilised material

Monitoring and adjustment of the moisture content of the stabilised materials is critical to the performance of the finished subgrade.

The moisture ratio of the stabilised material after the final wet incorporation of stabilising agent pass but before compaction should be in the range specified in Technical Specification MRTS07A *Insitu Stabilised Subgrades using Quicklime or Hydrated Lime*, Clause 8.8 *Product standards*.

As a minimum frequency, the relative moisture ratio of stabilised materials is assessed at each test location for compaction tests.

## 7.6 Field testing - verification

Undertake testing to verify the design parameters, such as UCS are achieved using the test methods in Table 7.6.



**Table 7.6 – Test methods used for verification**

Property	Test method	Title
Field UCS	Q115	UCS of compacted materials
	Q251B	Preparation and compaction of field mixed stabilised materials
	Q135B	Curing of moulded specimens of stabilised materials

### 7.6.1 Field UCS

The UCS test provides additional information on expected field performance relative to design. Mould the field mixed material at field moisture content using standard compaction effort. Cure the moulded specimens under standard conditions prior to testing.

When sampling and making UCS specimens in the field, it is assumed the insitu moisture content will be close to the optimum moisture content of the material. If not, then the achieved dry density and dry density ratio will likely be well below the target. This will mean the UCS results for the samples will be lower than the target due to the moisture and density being lower than the targets; therefore, care is required in interpreting these results.

## 8 Storage of additives in the laboratory

### 8.1 Lime

#### 8.1.1 Importance of proper storage

The term 'lime' is used to describe two different products, 'quicklime' (CaO) and the hydrated form 'Hydrate' (Ca(OH)<sub>2</sub>). Quicklime is normally in a pebble or granular form while hydrate is a fine white powder. Each of these will react with products in the atmosphere and degenerate with age. With proper handling, the degeneration can be held to a minimum. It is important to keep all lime dry and in airtight containers. If lime is exposed to moisture or CO<sub>2</sub>, the following reactions can occur.

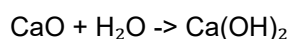

#### 8.1.2 Storage

It is best to obtain no more than a one two month supply of lime at a time.

Upon receipt, the total supply should be transferred from bags into airtight 'stock' containers; Ergotainers are recommended. The date received should be marked on each container.

It is helpful to 'tap' the full containers on the ground to achieve some degree of lime settling. This compaction will help limit atmospheric exposure of the lime below the surface.

A smaller 'lab' container is needed to hold the lime used in day-to-day testing.

The lab container must also be airtight and should hold a one two week supply. The use of a lab container avoids exposing the lime supply to the atmosphere and limits the number of times a stock container must be opened. The stock container only needs to be opened a couple of times a month rather than daily.

These care measures are important for both quicklime and hydrate. The presence of moisture catalyses carbonation, so it is especially important for hydrate, which inherently contains moisture.

Lime in the stock container should be discarded 12 weeks after it is received.

### **8.1.3 Use / sampling**

Each time lime is transferred from the stock container to a lab container the top 10–20mm of lime in the stock container should be discarded. When lime is added to the lab container the date should be marked on the container.

Before each testing job, the top 10–20mm of lime should be discarded from the lab container.

Prior to transferring lime from the stock container to the lab container, all lime remaining in the lab container should be discarded.

No container should be left open when not being used. If the lab container is to be unused for more than 10 minutes, close it tight.

Lime in the lab container should be discarded if it has been in the lab container for more than 14 days.

If care is taken to follow these storage methods, and stock is rotated often, the lime quality should remain at acceptable levels.

## **8.2 Cement**

### **8.2.1 Importance of proper storage**

The term 'cement' is used to describe General Purpose Portland cement or GP cement. It can also mean other forms of cementitious blended materials, consisting of combinations of pozzolanic material and cement and/or lime. Cement will react with moisture in the air and hydrate; this will reduce the efficacy of the cement with age. With proper handling, the hydration can be held to a minimum. It is important to keep cement dry and in airtight containers.

### **8.2.2 Storage**

It is best to obtain no more than a one two month supply of cement at a time.

Upon receipt, the total supply should be transferred from bags into airtight 'stock' containers; Ergotainers are recommended. The date received should be marked on each container.

It is helpful to 'tap' the full containers on the ground to achieve some degree of cement settling. This compaction will help limit atmospheric exposure of the cement below the surface.

A smaller 'lab' container is needed to hold the cement used in day-to-day testing.

The lab container must also be airtight and should hold a one to two-week supply. The use of a lab container avoids exposing the cement supply to the atmosphere and limits the number of times a stock container must be opened. The stock container only needs to be opened a couple of times a month rather than daily.

Cement in the stock container should be discarded 12 weeks after it is received.

### **8.2.3 Use / sampling**

Each time cement is transferred from the stock container to a lab container the top 10–20mm of cement in the stock container should be discarded. When cement is added to the lab container the date should be marked on the container.

Before each testing job, the top 10–20mm of cement should be discarded from the lab container.

Prior to transferring cement from the stock container to the lab container, all cement remaining in the lab container should be discarded.

No container should be left open when not being used. If the lab container is to be unused for more than 10 minutes, close it tight.

Cement in the lab container should be discarded if it has been in the lab container for more than 14 days.

If care is taken to follow these storage methods, and stock is rotated often, the cement quality should remain at acceptable levels.

## **8.3 *Supplementary cementitious materials***

### **8.3.1 Importance of proper storage**

Care needs to be taken to avoid contamination of the materials. While they do not deteriorate with age, discard after 12 months, as the sample may no longer represent the materials currently supplied.

### **8.3.2 Storage**

Source supplementary cementitious materials (fly ash, slag, silica fume and so on) directly from suppliers and keep dry in airtight containers.

### **8.3.3 Use / sampling**

Prior to transferring material from the stock container to the lab container, all material remaining in the lab container should be discarded.

## **8.4 *Admixtures***

### **8.4.1 Importance of proper storage**

Care needs to be taken to avoid contamination of admixtures. Unless otherwise advised by the supplier, discard after 12 months.

### **8.4.2 Storage**

Source admixtures (retarders, water reducers and so on) directly from suppliers and store as required by SDS, relevant laboratory procedures and regulatory requirements.

### **8.4.3 Use / sampling**

Prior to transferring material from the stock container to the lab container, all material remaining in the lab container should be discarded. Do not return material from lab container back into the stock container.

## Test Method Q020: Calculation of characteristic value of a lot

### 1 Source

This Test Method is based on the process for calculation of characteristic value as detailed in Department of Transport and Main Roads Technical Specification MRTS01 *Introduction to Technical Specifications*.

### 2 Scope

This Test Method provides a means for calculating a characteristic value determined by the analysis of several individual test results, tested using the same methods, using a statistical process. The characteristic value may then be used to determine the compliance of a product.

This Test Method is applicable where the test results are normally distributed.

### 3 Procedure

The procedure shall be as follows:

- 3.1 Perform the requested tests, using the same Test Methods, in accordance with the specified Test Methods (Notes 6.1, 6.2 and 6.3).
- 3.2 Use the acceptance constant from Table 12(a) or Table 12(b) of Technical Specification MRTS01 *Introduction to Technical Specifications* unless otherwise specified.
- 3.3 Using the unrounded values, perform the calculations detailed in Section 4.

### 4 Calculations

Calculations shall be made as follows:

- 4.1 Calculate the mean of the individual test results as follows:

$$\bar{X} = \frac{1}{n} \sum_{i=1}^n X_i$$

- where
- $\bar{X}$  = mean of the individual test results for  $i=1, 2, 3, \dots, n$
  - $n$  = number of test results
  - $X_i$  = the individual test result for  $i=1, 2, 3, \dots, n$

- 4.2 Calculate the standard deviation of the individual test results as follows:

$$s = \sqrt{\frac{\sum_{i=1}^n (X_i - \bar{X})^2}{(n - 1)}}$$

- where
- $s$  = standard deviation of the individual test results for  $i=1, 2, 3, \dots, n$
  - $n$  = number of test results
  - $X_i$  = the individual test result for  $i=1, 2, 3, \dots, n$
  - $\bar{X}$  = mean of the individual test results

4.3 Calculate the characteristic value using the appropriate method as follows:

4.3.1 For a minimum limit:

$$CV = \bar{X} - ks$$

where CV = characteristic value  
 $\bar{X}$  = mean of the individual test results  
k = an acceptance constant dependent upon the number of tests  
s = standard deviation of the individual test results

4.3.2 For a maximum limit:

$$CV = \bar{X} + ks$$

where CV = characteristic value  
 $\bar{X}$  = mean of the individual test results  
k = an acceptance constant dependent upon the number of tests  
s = standard deviation of the individual test results

## 5 Reporting

The following shall be reported:

- 5.1 Report the following values rounded to the number of significant figures which exceeds by one that normally reported for the individual test results:
- mean of the individual test results, and
  - standard deviation of the individual test results.
- 5.2 Report the characteristic value of the individual test results to the same rounding normally applied to individual test results (refer to Technical Specification MRTS01 *Introduction to Technical Specifications* Table 12(c)).
- 5.3 Report the following additional values:
- number of individual tests, and
  - acceptance constant (k) used to the nearest 0.001.
- 5.4 Report the following additional information:
- source of the acceptance constant (k) used, for example Technical Specification MRTS01 *Introduction to Technical Specifications* Table 12(a)
  - identification of the specification requiring the reporting of the characteristic value of the individual test results
  - statement that unrounded data was used to calculate the characteristic value, and
  - the number of this Test Method, that is Q020.

## **6 Notes on method**

- 6.1 This method is usually applied to the results of Test Methods AS 1289.5.4.1, AS 1289.5.7.1, AS 3706.4, AS 3706.5, Q140A, Q146, Q192 and Q311.
- 6.2 For example, when determining the relative compaction or voids of asphalt, the method used to determine the compacted density may be one of AS/NZS 2891.9.2, AS/NZS 2891.9.3, Q306C, Q306D or Q306E.
- 6.3 Where Test Method AS/NZS 2891.9.2 is used initially to determine the relative compaction of asphalt but is subsequently found not to be applicable to one or more samples due to excessive water absorption, a combination of test results from Test Methods AS/NZS 2891.9.2 and Q306C may be used.

## Test Method Q050: Random selection of sampling or test locations

### 1 Source

This Test Method applies the principles of AS 1289.1.4.1: *Selection of sampling or test sites – Random number method* and AS 1289.1.4.2: *Selection of sampling or test sites – Stratified random number method*. The principles within these methods have been modified and enhanced to provide procedures which better suit local methodology and practices.

### 2 Scope

This Test Method describes the procedure for establishing sampling locations, sampling intervals or test locations within a lot, which has been defined in terms of mass, volume, area or batches, using random selection techniques. The Test Method contains procedures which allow locations or intervals to be selected using either Random Sampling or Random Stratified Sampling. These procedures ensure that samples or tests are taken at locations or intervals which are distributed within a lot in such a way that bias is removed from the selection process.

### 3 Application

This Test Method shall be applied as follows:

- 3.1 Where the procedure for the selection of sampling and test locations is not specified in the appropriate specification, sampling plan or Test Method, apply this method as follows:
  - a) random stratified sampling procedures will be used for the selection of all sampling locations, sampling intervals or test locations, and
  - b) stockpiles, windrows or heaps are to be sampled using random stratified sampling described in Subsection 8.2: Selection of Location – Available Perimeter.
- 3.2 Where the process for re-sampling or re-testing a lot is not specified in the appropriate specification, apply this method as follows:
  - a) new sampling or testing locations will be determined for the entire lot, that is, no original sampling or testing locations will be used.
- 3.3 Where the process for excluding any parts of the lot or sub-lot is not specified in the appropriate specification, sampling plan or Test Method, apply the following:
  - a) for compaction lots, exclude any parts of the lot or sub-lot which are within 200 mm of any edge or construction joint.

### 4 Apparatus

The following apparatus is required:

- 4.1 Tape measure, wheel meter, and staff and level as required.
- 4.2 Marking system, suitable marking equipment appropriate for the lot under consideration (for example, spray paint, flagging tap or pegs).

## **5 Lot size and sampling or testing frequencies**

Determine the lot's size and sampling or testing frequencies as follows:

- 5.1 Determine the size or extent of the lot, together with the number of samples or tests to be taken, using the specification, sampling plan or test methodology as appropriate.
- 5.2 Where more than one representative sample is to be taken, divide the lot into the same number of approximately equal size sub-lots (Note 11.1). Mark the boundaries of each sub-lot using a suitable marking system.

## **6 Random numbers**

Obtain and use random numbers as follows:

- 6.1 Obtain a listing of sequential random numbers in accordance with Test Method AS 1289.1.4.1 or Test Method AS 1289.1.4.2.
- 6.2 Each random number shall be used for the calculation of only one:
  - a) longitudinal, lateral or vertical coordinate
  - b) position on the perimeter of a lot or sub-lot, or
  - c) sampling or testing interval.

## **7 Random sampling**

The procedure for random sampling shall be as follows:

### **7.1 Selection of location – available area**

- 7.1.1 Determine the extent of the area within the lot or sub-lot which is available for sampling or testing by referring to the specification, sampling plan or test methodology as appropriate.
- 7.1.2 Select the random location within an available area in accordance with Test Method AS 1289.1.4.1.

### **7.2 Selection of location – available perimeter**

- 7.2.1 Measure the accessible perimeter of the lot or sub-lot (Notes 11.2 and 11.3).
- 7.2.2 Select the random location within an available perimeter in accordance with Test Method AS 1289.1.4.1.

### **7.3 Selection of location – interval**

Select the random location within an interval in accordance with Test Method AS 1289.1.4.1.

## **8 Random stratified sampling**

The procedure for random stratified sampling shall be as follows:

### **8.1 Selection of location – available area**

- 8.1.1 Determine the extent of the area within the lot or sub-lot which is available for sampling or testing by referring to the specification, sampling plan or test methodology as appropriate.
- 8.1.2 Select the random stratified location within an available area in accordance with Test Method AS 1289.1.4.2.



## **8.2 Selection of location – available perimeter**

- 8.2.1 Measure the accessible perimeter of the lot or sub-lot (Notes 11.2 and 11.3).
- 8.2.2 Select the random stratified location within an available perimeter in accordance with Test Method AS 1289.1.4.2.

## **8.3 Selection of location – interval**

Select the random stratified location within an interval in accordance with Test Method AS 1289.1.4.2.

## **9 Records**

The following shall be recorded:

- 9.1 Date of sampling / testing.
- 9.2 Random numbers used.
- 9.3 Longitudinal, lateral and, if required, vertical coordinates of each sampling / test site.
- 9.4 Position on the perimeter of each sampling / test location.
- 9.5 Quantity of material produced, processed, batched or loaded at which a sample / test is taken.
- 9.6 Lot identification, sub-lots, field sample numbers, increment numbers.
- 9.7 Name of sampler.
- 9.8 Specific sampling procedure used with reference to the relevant subsection of this method.
- 9.9 For selection of locations by available area or perimeters, a dimensioned plan of the lot / sub-lots showing sample increment locations together with points of reference and, where appropriate, sub-increment locations.
- 9.10 Any other relevant information.

## **10 Reporting**

The following shall be reported:

- 10.1 Date of sampling / testing.
- 10.2 Longitudinal, lateral and, if required, vertical location of each sampling / test site.
- 10.3 Quantity of material produced, processed, batched or loaded at which a sample / test is taken.
- 10.4 Lot identification.
- 10.5 Specific sampling procedure used with reference to the relevant subsection of this method.
- 10.6 The number of this Test Method, that is Q050.

## **11 Notes on method**

- 11.1 The sample increments for each representative sample are taken randomly throughout a sub-lot in the same way that spot samples and tests are taken throughout a lot.
- 11.2 It is not always possible to obtain free access to all sides of some lots or sub-lots (for example, a stockpile lot). In such cases, determine the combined accessible length.
- 11.3** For windrows, it is only necessary to measure the length of each lot or sub-lot.

## Test Method Q060: Representative sampling of soils, crushed rock and aggregates

### 1 Source

This Test Method applies the principles of AS 1141.3.1: *Sampling – Aggregates* while including additional techniques for the sampling of materials both in motion during production and when stationary.

### 2 Scope

This Test Method describes the procedures for obtaining representative samples of soils, crushed rock and aggregates having a nominal size up to 63 mm. The method is applicable to produced materials in motion on a conveyor belt or at the point of discharge, as well as stationary materials contained within a stockpile, truck, bin, heap or windrow. The method may not be applicable to circumstances where spot sampling techniques are more appropriate (for example where determining stockpile segregation).

### 3 Application

This Test Method shall be applied as follows:

Generally, it is preferable to sample produced materials when in motion prior to or during discharge. However, this may not be safe or practical for all such circumstances and this approach is not applicable for sampling non-processed materials or stationary produced materials. Adequate samples can be obtained from stationary materials provided due care is exercised.

Consider each procedure for sampling moving or stationary material as contained within this method to be of equal technical validity. Where multiple sampling options are available for a situation, there is no hierarchy of preference, and each procedure will provide an adequate representative sample.

Consider the following limitations when selecting a sampling procedure:

- a sampling tube can only be used for sampling free flowing fine grained material, and
- the use of hand tools to sample aggregates from a stockpile, heap or windrow is limited to those aggregates having a nominal size of up to and including 28 mm.

### 4 Apparatus

An example of sampling tube is contained in AS 1141.3.1 Figure 2.

The following apparatus is required:

- 4.1 Sample containers, woven sample bags or other suitable sealable containers that will prevent fines loss. Airtight containers are required for moisture content samples. Containers are to be of a size or so configured that their maximum capacity is approximately 20 kg.
- 4.2 Flat bottomed scoop or trowel and brush.
- 4.3 Loader, having a bucket with a capacity of at least 1 m<sup>3</sup>, capable of obtaining a slice of material from the total height of the side of the stockpile under consideration in a single movement (Note 13.1).
- 4.4 Excavator, having a bucket with a capacity of at least 1 m<sup>3</sup>, capable of reaching to the total height of the stockpile.

4.5 Shovels:

- a) Standard shovel, a standard square mouth shovel with raised sides having a blade of approximate dimensions 300 mm length and 200 mm width.
- b) Posthole shovel, a square mouth posthole shovel having a blade of approximate dimensions 300 mm length and 200 mm width.
- c) Farmer's shovel, with a minimised square mouth having a blade of approximate dimensions 300 mm length, 240 mm width and mouth width of 130 mm for coarse materials such as railway ballast.

4.6 Sampling tube, consisting of a 75 mm to 100 mm diameter thin walled tube with an opening or a series of openings in a straight line parallel to the longitudinal axis.

4.7 Digging tools such as a pick or crowbar.

4.8 Tape measure, wheel meter and staff and level as required.

## 5 Definitions

For this Test Method the following definitions shall apply:

5.1 Sample Increment – The amount of material taken to form part of a sample. The number of sample increments required to form a sample shall be at least five.

5.2 Sampling Interval – The mass or volume of material to be produced, processed or loaded before a sample increment or a number of sub-increments is obtained.

5.3 Sampling Point – The position within a body of material, where a sub-increment is obtained for combination with other sub-increments to form a sample increment. The term 'sampling point' is only used when material is taken from more than one position for a sampling location or sampling interval.

## 6 Sampling procedure and locations

The procedure for selecting a sampling procedure and locations shall be as follows:

6.1 Taking account of the type of material to be sampled and the type and scope of testing, select a sampling procedure which is appropriate for existing conditions and available resources.

6.2 Where sampling from stockpiles using Test Method AS 1141.3.1, the purpose of the sampling shall be as follows:

- a) where a single sample is required from a lot / stockpile, sample for testing of average properties, or
- b) where multiple samples are required from a lot / stockpile, sample for testing of average properties and variation.

6.3 Determine the number of samples to be taken within the lot in accordance with the requirements of the specification, sampling plan or testing methodology as appropriate.

6.4 Where more than one sample is required, divide the lot into the same number of approximately equal sub-lots.

6.5 Determine the minimum mass of material for each sample increment or sub-increment from Table 1 (Note 13.2).

- 6.6 Use random stratified sampling to determine sampling locations, or sampling intervals during production, for each sample in accordance with the requirements of the specification, sampling plan or testing methodology as appropriate.
- 6.7 For a moisture content sample, take all necessary precautions to prevent moisture loss both during and following sampling.

## **7 Sampling during discharge**

The procedure for sampling during discharge shall be as follows:

### **7.1 Moving stream – mechanical cutter**

Perform sampling from a moving stream using a mechanical cutter in accordance with Test Method AS 1141.3.1.

### **7.2 Stopped conveyor belt**

Perform sampling from a stopped conveyor belt in accordance with Test Method AS 1141.3.1.

### **7.3 Moving stream - loader bucket**

- 7.3.1 At the predetermined sampling interval, have an authorised operator discharge at least 1 m<sup>3</sup> of material into a loader bucket.
- 7.3.2 Have the loader parked in a safe location away from other traffic with the bucket resting on the ground.
- 7.3.3 Locate the highest point of the material and flatten the load by removing material to a depth of at least 200 mm to form a level surface approximately 500 mm wide and 750 mm long.
- 7.3.4 Obtain the required number of sample increments at uniformly distributed positions across the surface of the layer. At each position undertake the following:
  - a) Insert the blade of the standard shovel vertically into the layer for the full depth of the blade, then place the excavated material in the sample container (Note 13.3). If more material is required, widen the hole helically by obtaining adjacent shovels-full of material using the excavation technique described in this step.
  - b) Label or otherwise identify the sample container with the field sample number and the increment number. The increment number has to include the number of sample increments required for the sample. For example, 1/4 identifies the first sample increment in four increments.

### **7.4 Moving stream - truck**

- 7.4.1 At the predetermined sampling interval, have an authorised operator discharge at least 1 m<sup>3</sup> of material into a truck. Have the selected truck parked in a safe location away from other traffic.
- 7.4.2 Gain access to the tray of the truck using a ladder or platform. Locate the longitudinal axis of the load or, if the truck is loaded off-centre, the axis which passes through the highest points.
- 7.4.3 Locate the centre of the longitudinal axis. At this location, flatten the load by removing material to a depth of at least 200 mm to form a level surface approximately 500 mm wide and 750 mm long.

- 7.4.4 Obtain the required number of sample increments at uniformly distributed positions across the surface of the layer. At each position undertake the following:
- a) Insert the blade of the standard shovel vertically into the layer for the full depth of the blade, then place the excavated material in the sample container (Note 13.3). If more material is required, widen the hole helically by obtaining adjacent shovels-full of material using the excavation technique described in this step.
  - b) Label or otherwise identify the sample container with the field sample number and the increment number. The increment number has to include the number of sample increments required for the sample. For example, 1/4 identifies the first sample increment in four increments.

## **8 Sampling from formed stockpiles**

The procedure for sampling from formed stockpiles shall be as follows:

### **8.1 Single layer formed stockpile – loader remove and mix**

Perform sampling from a single layer formed stockpile by loader remove and mix technique in accordance with Test Method AS 1141.3.1.

### **8.2 Single layer formed stockpile – loader back blading**

Perform sampling from a single layer formed stockpile using back blading in accordance with Test Method AS 1141.3.1.

### **8.3 Single layer formed stockpile – hand tools**

Perform sampling from a single layer formed stockpile using hand tools in accordance with Test Method AS 1141.3.1.

### **8.4 Multiple layer formed stockpile – excavator remove and mix**

- 8.4.1 At a predetermined sampling location, expose a fresh face for the total height of the side of the stockpile and at least to twice the width of the excavator bucket by dragging material down with the excavator bucket. Dump the removed material on the stockpile at a location that will not interfere with the sampling process.
- 8.4.2 Remove sufficient material from the total height of the fresh face using the technique described in Step 8.4.1 to form a level mixing pad adjacent to the stockpile. The pad is to be of sufficient area to accommodate material from the nominated sampling location and allow uniform mixing.
- 8.4.3 Obtain material for depositing on the mixing pad by removing a uniform slice, at least one excavator bucket wide, for the total height of the exposed face using the technique described in Step 8.4.1. Deposit the material in the centre of the prepared mixing pad, ensuring that the bucket discharge height is as low as possible.
- 8.4.4 Repeat Step 8.4.3 until sufficient material to allow uniform mixing is available on the mixing pad.
- 8.4.5 Thoroughly mix the deposited material using a loader, working from various points around the pad, ensuring that the material deposited on the pad is uniformly mixed. While it is acceptable that some pad material may be included in the mixing process, terminate the sampling exercise if the mixture becomes contaminated with foreign material from the stockpile floor. Level the mixed material to form a layer approximately 500 mm thick above the mixing pad.

- 8.4.6 Obtain the required number of sample increments at uniformly distributed positions across the surface of the layer and not less than 200 mm from the edge. If the surface of the levelled material is rippled due to the loader bucket, remove sufficient material to expose a fresh and level surface at each sampling position. At each position undertake the following:
- a) Insert the blade of the standard shovel vertically into the layer for the full depth of the blade, then place the excavated material in the sample container (Note 13.3). If more material is required, widen the hole helically by obtaining adjacent shovels-full of material using the excavation technique described in this step.
  - b) Label or otherwise identify the sample container with the field sample number and the increment number. The increment number has to include the number of sample increments required for the sample. For example, 1/4 identifies the first sample increment in four increments.

### **8.5 Multiple layer formed stockpile – loader remove and mix**

Perform sampling from a multiple layer formed stockpile using loader remove and mix in accordance with Test Method AS 1141.3.1.

## **9 Sampling from heaps or windrows**

The procedure for sampling from heaps or windrows shall be as follows:

### **9.1 Heap - hand tools**

Perform sampling from heaps using hand tools in accordance with Test Method AS 1141.3.1.

### **9.2 Heap - sampling tube**

- 9.2.1 At a predetermined sampling location, mark a sampling point on the side of the heap, measured from the base. The point should not be within 200 mm of the base of the heap or 200 mm of the top of the heap (Note 13.4).

- 9.2.2 At the sampling point, obtain an increment to form a sample as follows:

- a) Insert the tube horizontally into the side of the heap with the slot facing downwards. Rotate the tube through 180°, then withdraw the tube. Place the material from the tube into the sample container.
- b) Label or otherwise identify the sample container with the field sample number and increment number. The increment number includes the number of sample increments required for the sample. For example, 1/4 identifies the first sample increment in four increments.

- 9.2.3 Repeat Step 9.2.2 until the required number of sample increments, having similar quantities of material, is obtained for each sample.

### **9.3 Windrow - hand tools**

Perform sampling from heaps or windrows using hand tools in accordance with Test Method AS 1141.3.1.

## **10 Sampling from bins and trucks**

The procedure for sampling from bins and trucks shall be as follows:

### **10.1 Bins**

Perform sampling from bins in accordance with Test Method AS 1141.3.1.

## **10.2 Trucks**

Perform sampling from trucks in accordance with Test Method AS 1141.3.1.

## **11 Records**

The following information shall be recorded on each sample container or on a tag affixed to the container using a durable permanent marker (Note 13.5).

- 11.1 Date of sampling.
- 11.2 Material type.
- 11.3 Source of material.
- 11.4 Nominal size (mm).
- 11.5 Sampling location including GNSS reference if required.
- 11.6 Amount of material represented.
- 11.7 Lot identification, sub-lots, field sample numbers, increment numbers.
- 11.8 Name of sampler.
- 11.9 Specific sampling procedure used with reference to the relevant subsection of this method.
- 11.10 For material in a stockpile, heap or windrow, a dimensioned plan of the lot showing sample increment locations together with points of reference and, where appropriate, sub-increment locations.
- 11.11 Any other relevant information.

## **12 Reporting**

The following shall be reported:

- 12.1 Date of sampling.
- 12.2 Material type.
- 12.3 Source of material.
- 12.4 Sampling location.
- 12.5 Lot identification.
- 12.6 Specific sampling procedure used with reference to the relevant subsection of this method.
- 12.7 The number of this Test Method, that is Q060.

## **13 Notes on method**

- 13.1 Since the loader is capable of stockpiling to a height approximately 300 mm more than its reach, it is acceptable to use the same loader for sampling as was used for stockpile formation.
- 13.2 The number of increments, masses of sample increments and masses of samples are the minimum requirements to obtain a representative sample. For testing programmes, more increments and/or larger increment masses may be needed to obtain sufficient representative material.

- 13.3 When sampling coarse materials such as rail ballast, the farmer's shovel should be used. To facilitate removal of aggregate, place the shovel mouth on the surface of the material to be sampled. Stabilise the shovel by placing two hands on the upper half of the shovel handle and one foot on the broad footing area on the top of the shovel head. Step up on the footing area of the shovel head and, by placing the second foot together with the operator's jolting body weight, drive the shovel home.
- 13.4 When sampling for moisture content, it is necessary to consider the likely moisture gradient within the heap. Select additional sampling points to achieve a distribution which is consistent with the cross-section of the heap.
- 13.5 Sampling information may be recorded on a sampling log or worksheet provided there is a clear and unambiguous link from the record to each container.

**Table 1 – Sample increment masses**

<b>Nominal size (mm)</b>	75	40	28	20	14	10	7	5	<5
<b>Minimum mass (kg)</b>	10	6	5	4	3	2	2	1	1

**Table 2 – Sample masses**

<b>Nominal size (mm)</b>	75	40	28	20	14	10	7	5	<5
<b>Minimum mass (kg)</b>	50	30	25	20	15	10	10	5	5



## Test Method Q061: Spot sampling of soils, crushed rock and aggregates

### 1 Source

This Test Method was developed in-house using techniques evolved through internal departmental investigations.

### 2 Scope

This Test Method specifies the procedures for obtaining spot samples of soils, crushed rock and aggregates of nominal size up to 63 mm. This Test Method is applicable to materials in compacted and uncompacted layers of earthworks or pavements or the discharge of plant such as pug mills into loader buckets or trucks.

This Test Method does not cover sampling soils for environmental purposes or representative sampling of lots or sub-lots. Representative sampling is covered by Test Method AS 1141.3.1.

### 3 Apparatus

Following is a comprehensive listing of apparatus required for this Test Method. While some items are common to all procedures, others are specific to a procedure.

- 3.1 Sample containers which prevent fines loss. Airtight containers are required for moisture content samples. Containers are to be of a size or so configured that their maximum capacity does not exceed approximately 20 kg.
- 3.2 Flat bottomed scoop or trowel, broom and brush.
- 3.3 Shovels:
  - a) Standard shovel, a standard square mouth shovel with raised sides having a blade of approximate dimensions, 300 mm length and 200 mm width.
  - b) Post hole shovel, a square mouth post hole shovel having a blade of approximate dimensions, 300 mm length and 200 mm width.
- 3.4 Hand digging tools such as a pick, crowbar or light electric hammer with variable speed control.
- 3.5 Plant (Note 10.1):
  - a) bobcat with a profiling / milling head
  - b) excavator with a profiling / milling head
  - c) profiler, or
  - d) insitu stabiliser.
- 3.6 Tape measure, wheel meter, and survey levelling equipment as required.
- 3.7 Marking system, suitable marking equipment appropriate for the lot under consideration (for example, spray paint, flagging tape or pegs).

### 4 Sampling location

The procedure for determining the number of samples and locations shall be as follows:

- 4.1 Determine the number of samples to be taken within the lot in accordance with the requirements of the specification, sampling plan or testing methodology as appropriate.

- 4.2 Use random stratified sampling to determine sampling locations, or sampling intervals during production, for each sample in accordance with the requirements of the specification, sampling plan or testing methodology as appropriate.

## **5 Sampling from compacted layer of earthworks or pavement**

The procedure for sampling from compacted layer of earthworks or pavement shall be as follows:

### **5.1 General sampling – hand tools**

- 5.1.1 Determine the quantity of material required for the testing programme, ensuring compliance with the minimum sample mass requirements in Table 1.
- 5.1.2 At the predetermined sampling location, remove any foreign material, making a note of its presence in the sampling record.
- 5.1.3 If not sufficiently loose, the layer shall be carefully loosened using suitable tools. Care should be taken not to unnecessarily break down any discrete rock particles.
- 5.1.4 Excavate a hole with approximately vertical sides and a flat bottom to the full depth of the layer being sampled. Ensure all loose material is recovered and that all material removed is retained as the sample.
- 5.1.5 For a moisture content sample, take all necessary precautions to prevent moisture loss, both during and following sampling. Ensure the sample container is sealed at the completion of sampling.
- 5.1.6 Label or otherwise identify the sample container with the field sample number. Sampling information may be recorded on a sampling log or worksheet provided there is a clear and unambiguous link from the record to each container.

### **5.2 MDD / OMC sample – sand replacement**

- 5.2.1 Determine the quantity of material required, ensuring compliance with the minimum sample mass requirements in Table 1.
- 5.2.2 Ensure the location for the sample and the surrounding surface is cleaned of loose density sand and any other foreign material.
- 5.2.3 Enlarge the test hole to obtain sufficient compacted material to determine the MDD and OMC. Ensure the enlarged hole is to the same depth as the sand replacement test hole, the sides are approximately vertical and the bottom of the hole is flat.
- 5.2.4 If not sufficiently loose, the layer shall be carefully loosened using suitable tools. Care should be taken not to unnecessarily break down any discrete rock particles.
- 5.2.5 Ensure all loose material is recovered and that all material removed is retained as the sample.
- 5.2.6 Label or otherwise identify the sample container with the field sample number. Sampling information may be recorded on a sampling log or worksheet provided there is a clear and unambiguous link from the record to each container.

### **5.3 MDD / OMC sample and/or moisture content sample – nuclear gauge**

- 5.3.1 Determine the quantity of material required, ensuring compliance with the minimum sample mass requirements in Table 1.
- 5.3.2 Ensure the location for the sample and the surrounding surface is cleaned of loose sand and any other foreign material.

- 5.3.3 Locate the sampling position for the sample as shown in Figure 1.
- 5.3.4 Excavate a hole to one of the following depths:
  - a) The full depth of the layer where the sampled material is from a pavement or earthworks, or
  - b) The depth used in the nuclear gauge measurement of wet density where the sampled material is from earthworks and no layer depth is applicable.
- 5.3.5 Excavate a hole to obtain sufficient compacted material to determine the MDD / OMC and/or moisture content. Ensure the excavated hole has approximately vertical sides and a flat bottom.
- 5.3.6 If not sufficiently loose, the layer shall be carefully loosened using suitable tools. Care should be taken not to unnecessarily break down any discrete rock particles.
- 5.3.7 Ensure all loose material is recovered and that all material removed is retained as the sample.
- 5.3.8 For a moisture content sample, take all necessary precautions to prevent moisture loss, both during and following sampling. Ensure the sample container is sealed at the completion of sampling.
- 5.3.9 Label or otherwise identify the sample container with the field sample number. Sampling information may be recorded on a sampling log or worksheet provided there is a clear and unambiguous link from the record to each container.

#### **5.4 Sampling for stabilisation testing – plant excavation**

Plant such as a bobcat or excavator with a milling / profiling head may be used to expose and pre-treat earthworks or pavement intended for insitu stabilisation so that sampling may be performed.

- 5.4.1 Determine the quantity of material required for the testing programme, ensuring compliance with the minimum sample mass requirements in Table 1. Also determine if any material is to be excluded from the sample such as sprayed surfacing, asphalt or stabilised patches.
- 5.4.2 Ensure the location for the sample and the surrounding surface is cleaned of loose material.
- 5.4.3 If the seal is not to be incorporated into the insitu stabilisation use the plant to remove the seal before sampling.
- 5.4.4 Using the plant mill in lateral strips to the depth required by the stabilisation process.
- 5.4.5 Using a broom or shovel push any material outside the excavated strip back into the excavation.
- 5.4.6 Repeat Steps 5.4.4 to 5.4.5 two more times to simulate three passes of an insitu stabiliser.
- 5.4.7 Recover the material from the strip to the full depth of the layer being sampled. Ensure all loose material is recovered and that all material removed is retained as the sample.
- 5.4.8 Label or otherwise identify the sample container(s) with the field sample number. Sampling information may be recorded on a sampling log or worksheet provided there is a clear and unambiguous link from the record to each container.

## **6 Sampling from uncompacted layer of earthworks or pavement**

The procedure for sampling from uncompacted layer of earthworks or pavement shall be as follows:

- 6.1 Determine the quantity of material required for the testing programme, ensuring compliance with the minimum sample mass requirements in Table 1.
- 6.2 At the predetermined sampling location, remove any foreign material making a note of its presence in the sampling record.
- 6.3 If required, level the surface using a shovel.
- 6.4 If not sufficiently loose, the layer shall be loosened using suitable tools. Care should be taken not to unnecessarily break down discrete rock particles.
- 6.5 Excavate a hole with approximately vertical sides and a flat bottom to the full depth of the layer being sampled. Ensure all loose material is recovered and that all material removed is retained as the sample.
- 6.6 For a moisture content sample, take all necessary precautions to prevent moisture loss, both during and following sampling. Ensure the sample container is sealed at the completion of sampling.
- 6.7 For stabilised materials:
  - a) mark or otherwise identify the location so additional testing may be performed at the location after compaction is complete. Use of offset pegs and recording the distance from the peg to the sampling location using measuring tape or wheel meter has been found to be suitable, and
  - b) record the date and time mixing commences at the location.
- 6.8 Label or otherwise identify the sample container with the field sample number. Sampling information may be recorded on a sampling log or worksheet provided there is a clear and unambiguous link from the record to each container.

## **7 Sampling during discharge**

The procedure for sampling during discharge shall be as follows:

### **7.1 Moving stream - loader bucket**

- 7.1.1 At the predetermined sampling interval, have an authorised operator discharge at least 1 m<sup>3</sup> of material into a loader bucket.
- 7.1.2 Have the loader parked in a safe location away from other traffic with the bucket resting on the ground.
- 7.1.3 Locate the highest point of the material and flatten the load by removing material to a depth of at least 200 mm to form a level surface approximately 500 mm wide and 750 mm long.
- 7.1.4 Obtain a sample from near the centre of the levelled surface using the standard shovel. Insert the blade vertically into the surface for the full depth of the blade, then place the excavated material into the sample container. If more material is required, widen the hole helically by obtaining adjacent shovels-full of material using the excavation technique described in this step.

- 7.1.5 Label or otherwise identify the sample container with the field sample number. Sampling information may be recorded on a sampling log or worksheet provided there is a clear and unambiguous link from the record to each container.

## **7.2 Moving stream - truck**

- 7.2.1 At the predetermined sampling interval, have an authorised operator discharge at least 1 m<sup>3</sup> of material into a truck. Have the selected truck parked in a safe location away from other traffic.
- 7.2.2 Gain access to the tray of the truck using a ladder or platform. Locate the longitudinal axis of the load or, if the truck is loaded off-centre, the axis which passes through the highest points.
- 7.2.3 Locate the centre of the longitudinal axis. At this location, flatten the load by removing material to a depth of at least 200 mm to form a level surface approximately 500 mm wide and 750 mm long.
- 7.2.4 Obtain a sample from near the centre of the levelled surface using the standard shovel. Insert the blade vertically into the surface for the full depth of the blade, then place the excavated material into the sample container. If more material is required, widen the hole helically by obtaining adjacent shovels-full of material using the excavation technique described in this step.
- 7.2.5 Label or otherwise identify the sample container with the field sample number. Sampling information may be recorded on a sampling log or worksheet provided there is a clear and unambiguous link from the record to each container.

## **8 Recording**

Record the following information using a durable permanent marker on each sample container, sampling log, worksheet or tag affixed to the container:

- 8.1 Date of sampling.
- 8.2 Name of sampler.
- 8.3 Material type.
- 8.4 Sampling location, including GNSS reference if required.
- 8.5 Lot identification, field sample number and increment number.
- 8.6 Specific sampling procedure used with reference to the relevant section or subsection of this Test Method.
- 8.7 When sampling stabilised materials from an uncompacted layer of earthworks or pavement, the date and time mixing commences at the sampling location.
- 8.8 Any other relevant information.

## **9 Reporting**

The following shall be reported:

- 9.1 Date of sampling.
- 9.2 Material type.
- 9.3 Sampling location, including GNSS reference if required.
- 9.4 Lot identification.

9.5 Specific sampling procedure used with reference to the relevant section or subsection of this Test Method.

9.6 The number of this Test Method, that is Q061.

**10 Notes on method**

10.1 Generally, a bobcat will be used as the use of a profiler or insitu stabiliser will be impractical in most situations.

**Table 1 – Minimum sample masses**

<b>Nominal size (mm)</b>	63	53	40	28	20	16	14	10	7	5	2
<b>Minimum mass (kg)</b>	30	25	20	14	10	8	7	5	3.5	2.5	1

These sample masses are based on material with an apparent particle density of 2.65. The masses may need to be adjusted for exceptionally heavy or light material to provide a sample of equivalent volume.

**Figure 1 – Sampling location**

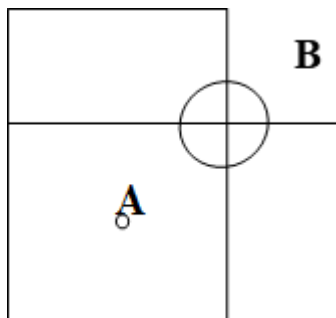

A: gauge probe access hole location (smaller circle).

B: location for MDD / OMC sample and/or moisture content sample (larger circle).

## Test Method Q070: Dry coring of bound materials

### 1 Source

This Test Method is based on Transport and Main Roads Test Method Q302A: *Dry coring of bound materials* that was developed in-house using techniques evolved through internal departmental research investigations. It differs from this Test Method by excluding the coring of asphalt.

### 2 Scope

This Test Method describes the procedure to obtain core specimens from stabilised materials such as soils and crushed rock. The Test Method is suitable for most lightly bound materials. However, difficulty may be encountered if coring is attempted at an early age before substantial strength development has occurred.

This Test Method also describes the procedure for the preparation of the core specimens prior to testing. It involves cleaning, separation and sectioning of the core specimen as appropriate.

### 3 Apparatus

The following apparatus is required:

- 3.1 Coring machine, consisting of:
  - a) Motor is to be equipped with a swivel assembly and hollow output shaft to allow air to flow via the inside of the coring bit to the cutting face during operation.
  - b) Drill stand able to be held securely in position during coring by either using ballast, applying a vacuum or engaging a mechanical locking device. The drill stand needs to allow linear vertical movement of the coring bit.
- 3.2 Thin walled coring bit, capable of producing core specimens having a diameter conforming to the requirements of Table 1.
- 3.3 Core extraction equipment, including pincers with curved blades, a length of 20 mm diameter rod and rubber mallet. The rod and mallet are to facilitate removal of cores retained within the coring bit.
- 3.4 Mechanical compactor, such as an electric demolition hammer for the compaction of patching material other than non-shrink grout. The compactor is to be equipped with a circular compaction plate having a diameter similar to that of the core hole.
- 3.5 Vacuum extraction system, capable of removing expelled air and dust from the region of the coring bit. The system should:
  - a) provide an adequate seal around the coring bit and with the surface to ensure removal of dust
  - b) be fitted with high efficiency particulate air (HEPA) filters
  - c) include a detachable hose that can be fitted with a nozzle to allow removal of dust from the surface and equipment.
- 3.6 Masonry saw.
- 3.7 Stiff wire brush.
- 3.8 Marking crayon.

## 4 Materials

The following materials are required:

- 4.1 Patching material, of a type which is compatible with the material being cored:
  - 4.1.1 Concrete - non-shrink grout (Note 9.1).
  - 4.1.2 Stabilised granular - fresh mixture of the material under test or a low strength non-shrink grout (Note 9.1).
- 4.2 Compressed air, a continuous supply to remove cuttings from the cutting face and to cool the coring bit.
- 4.3 Water-proof marker and plastic bags.
- 4.4 Bituminous emulsion for priming holes (asphalt patching only) (Note 9.1).

## 5 Sampling procedure

The procedure shall be as follows:

- 5.1 Select a coring bit which is suitable for the material being cored and which will provide specimens with a diameter specified in Table 1. Carefully examine the selected bit to ensure that it is not damaged or excessively worn. Out of shape bits, bits which rotate eccentrically or bits without sufficient diamond matrix must not be used since they are prone to produce cores which are irregularly shaped or fractured.
- 5.2 Assemble the coring machine and configure the machine to provide the appropriate rotational speed (Notes 9.2 and 9.3).
- 5.3 Locate the coring bit centrally over the selected test site and adjust the drill stand so that the coring bit is at right angles to the surface being cored.
- 5.4 Check the alignment of the bit by lowering it to the surface. Adjust the stand until the cutting face makes full contact with the surface, then secure the drill stand into position.
- 5.5 Raise the coring bit, and then start the motor. Adjust the air flow to ensure there is sufficient air return to flush fines from the cutting face and to cool the coring bit. Ensure the flow rate does not exceed the capacity of the dust extraction system. Start the dust extraction system.
- 5.6 Lower the bit and bed it into the surface using slight downward pressure if necessary. Once the bit is bedded, apply sufficient pressure to allow coring to proceed at a uniform rate without clogging the bit or significantly reducing the speed of rotation. Monitor and adjust the air flow to ensure there is sufficient air return to flush fines from the cutting face and to cool the coring bit without exceeding the capacity of the dust extraction system (Note 9.3).
- 5.7 Continue coring until the full depth of the layer has been cored or, where the coring is to be terminated partway through a layer, to a depth of at least 75 mm greater than that specified.
- 5.8 When coring is complete, raise the coring bit carefully from the hole and stop the motor and air flow. Remove any dust from the surface with the dust extraction system.
- 5.9 Remove the core without damage as follows:
  - 5.9.1 Where the core is sitting in the core hole, use the pincers to remove the core.
  - 5.9.2 Where the core is still attached to its base, use the pincers to grip and support the core over as much of its length as possible. Apply either a slight sideways pressure or a twisting action to detach the core. A twisting action is preferred if the core is to be separated at a layer interface.



- 5.9.3 Where the core is retained within the coring bit, use the rubber mallet to gently tap the sides of the bit to facilitate removal. If the core cannot be freed easily, remove the coring bit and use the 20 mm rod to push the core from the threaded end of the coring bit.
- 5.10 Inspect the core to ensure that it is intact, of the required length, cylindrical in shape, free from unwanted defects and that it has not been damaged or fractured during coring or extraction (Note 9.5).
- 5.11 Discard any defective core and obtain a replacement core in close proximity to the nominated site in accordance with Steps 5.4 to 5.11 (Note 9.4).
- 5.12 Label the core using a waterproof marker, and seal cores in plastic bags. All cores are to be packaged and stored so that they are not damaged in transit nor subjected to any artificial temperature conditions.
- 5.13 Reinststate the cored surface using an appropriate patching material as follows:
  - 5.13.1 Concrete pavement
    - a) Remove loose fines from the hole using the vacuum system.
    - b) Mix and fully compact the patching material in accordance with the manufacturer's instructions. Finish the surface flush with the cored surface and protect the patching material from traffic and the environment until final set has occurred.
  - 5.13.2 Stabilised granular pavement
    - a) Remove loose fines from the hole using the vacuum system.
    - b) Prepare a patching material by obtaining either fresh stabilised material, mix unbound material with the stabilising agent or obtain a low strength low shrink grout.
    - c) Compact the patching material in 50-75 mm lifts using the mechanical compactor to fully compact each layer.
    - d) Slightly overfill the hole so that the compacted patching material is at a height of approximately 5 mm above the cored surface.
    - e) Use the mechanical compactor to form the patching material into a convex mound.

## **6 Preparation of specimens**

Preparation of the core sample using the masonry saw shall be as follows:

- 6.1 Cut any base material, seal, tack coat or other foreign matter from the core sample using the masonry saw, ensuring that as much of the sample as possible remains (Notes 9.5, 9.7 and 9.8).
- 6.2 Where the core sample is required to be sectioned or where different bound layers within the core sample are required to be separated, perform the following procedure:
  - a) Cut the core sample at the required position(s) using the masonry saw (Notes 9.6 and 9.7).
  - b) Remove any loose material from the cut section(s) using the wire brush.
- 6.3 Mark the core sample or core sample sections as appropriate with an identification number.

## **7 Records**

The following information shall be recorded for each sample:

- 7.1 Date of sampling.
- 7.2 An identification number for each core.
- 7.3 Type of material.
- 7.4 Nominal size (mm).
- 7.5 The location of each core including a longitudinal (chainage) and a lateral (offset) reference. Where appropriate, include a plan to show the location of each test site.
- 7.6 Manufacturer of material.
- 7.7 Name of sampler.
- 7.8 A description of each core in terms of general condition, defects and density appearance.

## **8 Reporting**

The following shall be reported:

- 8.1 Date of sampling
- 8.2 Type of material.
- 8.3 Nominal size (mm).
- 8.4 The location of each core including a longitudinal (chainage) and a lateral (offset) reference.
- 8.5 Manufacturer of material, and
- 8.6 The number of this Test Method, that is Q070.

## **9 Notes on method**

- 9.1 Before handling any patching materials, the operator should consult the relevant SDS.
- 9.2 The appropriate rotational speed will vary for different coring machines. Typical speeds will be in the range of 700 rpm to 1000 rpm for 100 mm cores and 350 rpm to 650 rpm for 150 mm cores.
- 9.3 Should fines build up on the surface around the rotating bit, do not remove these with compressed air. They should be removed using the dust extraction system.
- 9.4 Some common causes of defective cores are as follows:
  - a) Rounded edges on the upper surface are caused by poor coring bit seating or by a bit which rotates eccentrically.
  - b) Irregular sides are a result of incremental change in the rotational plane of the coring bit due to the use of a worn bit and/or excessive downward pressure during coring.
  - c) Loss of fines from the surface of weakly bound (stabilised) materials can be due to the abrasive action of loose pieces of aggregate.
- 9.5 Where the cutting depth of the saw blade is smaller than the diameter of the core sample, the sample shall be rotated slowly during the cutting process.

- 9.6 Either compressed air or dry ice can usually be used to cool the saw blade. Where the core specimen is to be tested for properties which may be affected by water penetration into the sample, for example, compacted density, voids properties, cooling by dry ice is preferred.
- 9.7 The intention is that all material not belonging to the bound layer is removed. This may result in the loss of some of the bound layer. Where measurement of layer thickness is required, such measurement will then need to be performed prior to cutting the core specimen.

**Table 1 – Core diameter**

<b>Material/application</b>	<b>Test</b>	<b>Nominal size (mm)</b>	<b>Core diameter (mm)</b>
Concrete* or stabilised material#	UCS and density	Aggregate > 20	150
		Aggregate ≤ 20	100# or 150

\*It is preferred that concrete UCS specimens have a height to diameter (h/d) ratio of 2. Where the stipulated diameter isn't practical for thin layers, cores having lesser diameters can be taken provided the diameter is 4 times the nominal maximum particle size and the h/d ratio is not less than 1.

#It is preferred that stabilised material UCS specimens have a height to diameter (h/d) ratio of 1.15. Generally 100 mm diameter cores should always be taken provided the height diameter ratio is not less than 1.15 or greater than 2.0.

## Test Method Q080: Sampling of bituminous binder

### 1 Source

This Test Method is based on the Main Roads Western Australia Test Method WA 700.1: *Sampling procedures for bitumen and oils*.

### 2 Scope

This Test Method describes the procedure for sampling for testing purposes of bituminous binders (including cutting or fluxing oils or combinations thereof) from bulk storage tanks, ship tankers, rail or road tankers, sprayers, drums and pavements.

This Test Method does not attempt to address all of the safety concerns, if any, associated with its use. The user of this Test Method is responsible for establishing appropriate occupational health and safety practices that meet statutory regulations.

Exercise extreme caution when sampling hot binders, cutbacks or blends, as there is a severe risk of injury due to burns or fire. Wear protective clothing when sampling. No smoking in the general vicinity when sampling. Do not sample through an open hatch of a tank.

Install low pressure in-line sampling cocks on the suction side of a pump and never install on the pressure side.

### 3 Apparatus

The following apparatus may be required depending on the procedure used for sampling:

- 3.1 Sample containers, minimum 1 litre capacity double-tight friction-top tins (Note 10.1).
- 3.2 Low pressure in-line sampling cock. An example is in MRWA Test method WA 700.1 Figure 1.
- 3.3 High pressure in-line sampling cock. An example is in MRWA Test method WA 700.1 Figure 2.
- 3.4 Weighted sampling bottle.
- 3.5 Core cutter with a diamond bit minimum 100 mm diameter, complete with air or water supply.
- 3.6 Flat trays, sample tins or clean bags for pavement samples.
- 3.7 Diamond or compound saw.
- 3.8 Sampling tools, for example, shovel or scoop.

### 4 Bulk storage - sampling during transfer or circulation

The procedure for sampling from bulk storage during transfer or circulation shall be as follows:

- 4.1 Perform sampling during transfer or circulation when material in storage tanks, rail or road tankers, ship tankers, sprayers or is flowing through a pipeline or hose and a suitable in-line sampling cock is available. For road tankers or sprayers, circulate the binder for a minimum of 15 minutes prior to sampling.
- 4.2 Select the quantity of material or duration of transfer that will constitute the sampled lot.
- 4.3 Determine the number of test samples required.
- 4.4 Take each test sample in accordance with Step 4.7 or 4.8.

4.5 If only a representative value of a material property is required and not its variability, then combine all test samples from a lot to give a single bulk sample provided the test samples are of approximately the same size and the test property is not distorted by this procedure.

4.6 Label or otherwise identify the sample container with the field sample number and increment number. The increment number has to include the number of sample increments required for the sample. For example, 1/4 identifies the first sample increment in a total of four increments.

#### **4.7 Sampling from other than spray bars**

4.7.1 Fit a thoroughly clean and dry sampling cock in position (if not already fitted).

4.7.2 Open the sampling cock and discharge to waste about 4 litres of material to ensure there is no contamination of subsequent samples.

4.7.3 Take each test sample by discharging material from the sampling cock into a clean container taking care to avoid spillage (Note 10.2). Take a test sample of about 1 litre. Seal the container as soon as possible after sampling.

#### **4.8 Sampling from spray bars**

4.8.1 This sampling can only be undertaken while the sprayer is stationary.

4.8.2 Place a container on the ground and carefully turn on the nozzle manually. Discharge to waste about 4 litres of material to ensure there is no contamination of subsequent samples.

4.8.3 Take each test sample by discharging material from the spray bar by carefully turning the nozzle on manually into a clean container placed on the ground taking care to avoid spillage (Note 10.2). Take a test sample of about 1 litre. Seal the container as soon as possible after sampling.

### **5 Bulk storage - sampling when there is no transfer or circulation**

The procedure for sampling from bulk storage when there is no transfer or circulation shall be as follows:

5.1 This section refers to sampling material from storage tanks, rail tankers, road tankers, sprayers or mobile storage tanks when the material is not being transferred or circulated through a pipeline or hose. The nature of bulk storage tanks only permits the use of spot sampling. Sampling cocks fixed directly to the tank, or its outlet, may be used. The use of fixed sampling cocks only allows a sample increment to be taken from material in the immediate vicinity of the sampling cock. This material may not be representative of the contents of the tank. Only use this sampling method where there are no other options for obtaining a test sample.

5.2 Open the sampling cock and discharge to waste about 4 litres of material to ensure there is no contamination of subsequent samples.

5.3 Take at least one sample increment for each test sample by discharging material from the sampling cock into a clean container taking care to avoid spillage (Note 10.2). Take a test sample of at least 1 litre. Seal the container as soon as possible after sampling.

5.4 Label or otherwise identify the sample container with the field sample number and increment number. The increment number must also include the number of sample increments required for the sample. For example, 1/4 identifies the first sample increment in a total of four increments.

## **6 Sampling from drums**

The procedure for sampling from drums shall be as follows:

- 6.1 Perform random sampling from drums only when the material can flow easily.
- 6.2 Select the quantity of material that will constitute sampled lot.
- 6.3 Determine the required number of drums to sample.
- 6.4 Take each test sample in accordance with Step 6.7 or 6.8.
- 6.5 If only a representative value of a material property is required and not its variability, then combine all test samples from a lot to give a single bulk sample provided the test samples are of approximately the same size and the test property is not distorted by this procedure.
- 6.6 Label or otherwise identify the sample container with the field sample number and increment number. The increment number must also include the number of sample increments required for the sample. For example, 1/4 identifies the first sample increment in a total of four increments.

### **6.7 Liquid Material**

- 6.7.1 Agitate the drum to provide a single uniform sample then take a test sample or sample increment using either a sampling cock, a sampling bottle or a pump.
- 6.7.2 Transfer the material to a clean container taking care to avoid spillage (Note 10.3).
- 6.7.3 Take a test sample of at least 1 litre and seal the container as soon possible after sampling (Note 10.2).

### **6.8 Solid Material**

- 6.8.1 Take a test sample or sample increment from a sample site at least 100 mm below the surface and at least 100 mm from the side of the container. A clean hatchet may be used if the material is hard enough to shatter or a broad stiff knife if the material is soft.
- 6.8.2 Transfer the material to a clean container.
- 6.8.3 Take a test sample of at least 1 litre and seal the container as soon as possible after sampling (Note 10.2).

## **7 Sampling from pavements**

The procedure for sampling from pavements shall be as follows:

- 7.1 This method is for the sampling of bitumen for pavement investigations. Cut the sample from the pavement using a cutting disc, corer or manual tools such as crowbar or pick. This Test Method is not for sampling for quality control or quality assurance testing.
- 7.2 Determine the number of test samples required.
- 7.3 Determine the boundaries of the section to sample.
- 7.4 Take each test sample by cutting around the boundary of the sample site taking care to ensure minimum disturbance of the slab. Use suitable cooling if required.
- 7.5 Cut the test sample to or beyond the full depth of the layer sampled.
- 7.6 Remove the test sample with the minimum disturbance of the slab and place in a clean container. Sample sufficient material to satisfy the requirements of all proposed tests.

- 7.7 Label or otherwise identify the sample container with the field sample number and increment number. The increment number must also include the number of sample increments required for the sample. For example, 1/4 identifies the first sample increment in a total of four increments.

## **8 Recording**

Record the following information using a durable permanent marker on each sample container, sampling log, worksheet or tag affixed to the container:

- 8.1 Identification of storage vessel.
- 8.2 Date of sampling.
- 8.3 Name of sampler.
- 8.4 Material type, classification of binder.
- 8.5 Supplier.
- 8.6 Sampling location.
- 8.7 Lot identification, field sample number and increment number.
- 8.8 Amount of material represented.
- 8.9 Specific sampling procedure used with reference to the relevant subsection of this method.
- 8.10 Any other relevant information.

## **9 Reporting**

The following shall be reported:

- 9.1 Date of sampling.
- 9.2 Material type, classification of binder.
- 9.3 Sampling location.
- 9.4 Lot identification.
- 9.5 Specific sampling procedure used with reference to the relevant subsection of this Test Method.
- 9.6 The number of this Test Method, that is Q080.

## **10 Notes on method**

- 10.1 New paint tins with handles are suitable.
- 10.2 Allow sufficient room for expansion or contraction of the material in the container.
- 10.3 To avoid contamination, it may be necessary to discharge to waste the initial material withdrawn.

## Test Method Q101: Preparation of disturbed samples

### 1 Source

This Test Method was developed in-house using techniques evolved through internal Department of Transport and Main Roads investigations.

### 2 Scope

This Test Method describes procedures for preparing samples of soil and aggregate as received from the field for testing. The preparation includes sample assessment, breaking up of aggregations of fines and soil clods and removal of coatings of fines from aggregate particles. After combining the bulk sample and splitting out representative subsamples, this Test Method references other methods for sample combination and splitting, sample reduction, fractionation, crushing, blending, pre-treatment, separation by screening or sieving and washing.

This Test Method also includes techniques for preparing Winton Sandstone (Vanderstaay 2000).

### 3 Apparatus

The following apparatus is required:

- 3.1 Drying oven of suitable capacity, having a temperature of 45-50°C and conforming to AS 1289.0.
- 3.2 Balance of suitable capacity, with a resolution of at least 1 g and with a limit of performance within the range of + 5 g to weigh subsamples during preparation.
- 3.3 Screen, 10 mm.
- 3.4 Sieves, 37.5 mm, 19.0 mm, 9.50 mm, 4.75 mm and 2.36 mm conforming to ISO 3310.
- 3.5 Sample preparation machine (shredder).
- 3.6 Sample preparation machine (mulcher).
- 3.7 Knife for slicing clay lumps.
- 3.8 Mixing apparatus, for example, shovel, scoop or trowel.
- 3.9 Sample containers which prevent fines loss. Airtight containers are required for moisture content samples. Containers are to be of a size or so configured that their maximum capacity does not exceed approximately 20 kg.
- 3.10 Suitable trays or containers for oven or air drying of subsamples.

### 4 Preliminary sample preparation

Preliminary sample preparation shall be as follows:

#### 4.1 Sample assessment

- 4.1.1 Assess the bulk sample to determine if it is in a free-flowing condition and contains any large aggregations of fines or soil clods (Notes 6.1 and 6.2).
- 4.1.2 If the sample is free-flowing and contains no large aggregations, then conduct the preliminary sample preparations in accordance with subsection 4.3.
- 4.1.3 If the sample is not in an acceptable condition, then pre-condition it in accordance with Subsection 4.2 and prepare the preconditioned sample in accordance with subsection 4.3.



## 4.2 Sample preconditioning

- 4.2.1 If the moisture content 'as received' is required, combine and split by coning and quartering the bulk sample in accordance with the appropriate subsection(s) in Test Method Q101A until the required test subsample is obtained.
- 4.2.2 Test the subsample to determine its moisture content ( $w$ ) in accordance with Test Method AS 1289.2.1.1 or one of the subsidiary Test Methods AS 1289.2.1.2, AS 1289.2.1.4, AS 1289.2.1.5 or AS 1289.2.1.6, for which a relationship with Test Method AS 1289.2.1.1 has been established and used in accordance with Test Method AS 1289.2.3.1. Alternatively, seal the subsample in an airtight container and test in accordance with subsection 5.1 (Note 6.3).
- 4.2.3 Air dry or oven dry at 45-50°C the remaining material until a free-flowing condition is reached. To facilitate drying, any clay lumps may be sliced prior to drying or shredded using a shredder or mulcher.
- 4.2.4 Break up any large aggregations of fines or soil clods in accordance with the appropriate subsection(s) in Test Method Q101D and mix back into the remainder of the sample.
- 4.2.5 For Winton Sandstone samples, screen the sample on a 2.36 mm sieve in accordance with Test Method Q101H. Recombine the material retained on the 2.36 mm sieve with the material passing the 2.36 mm sieve (Note 6.4).

## 4.3 Sample combination and splitting

- 4.3.1 Combine the bulk sample, if necessary, to form representative subsamples in accordance with the appropriate subsection in Test Method Q101A (Note 6.3).
- 4.3.2 Estimate the approximate quantity of material required for the testing program from the appropriate test method(s).
- 4.3.3 Further split the representative subsample(s) to provide subsamples for each test in the testing program using the appropriate subsection in Test Method Q101B.
- 4.3.4 Air or oven dry the subsamples which require drying prior to further preparation or testing. Use a temperature of 45-50°C for oven drying unless otherwise specified in the appropriate test method.
- 4.3.5 Set aside subsamples which do not require drying for further preparation or testing.

## 4.4 Subsample blending

- 4.4.1 Obtain the blend proportions from the client request, appropriate specification or testing methodology ( $p_i$ ), for example, subsample 1 0.2 ( $p_1$ ), subsample 2 0.3 ( $p_2$ ) and sub-sample 3 0.5 ( $p_3$ ).
- 4.4.2 Estimate the target dry mass of material required for the testing program from Step 4.3.2 ( $m_i$ ).
- 4.4.3 Test each subsample to determine its hygroscopic moisture content ( $w_i$ ) in accordance with Test Method AS 1289.2.1.1 and place each subsample in airtight container(s).
- 4.4.4 Blend the subsamples in accordance with Test Method Q101G.
- 4.4.5 Place the prepared test subsample(s) in an airtight container.

## 4.5 Pretreatment

Where there is a requirement to simulate the material breakdown that will occur during the construction process, pre-treat the subsample in accordance with Test Method Q101E (Note 6.5).

## **5 Test subsample preparation**

Test subsample preparation shall be as follows:

### **5.1 Moisture content subsamples**

- 5.1.1 Reduce the subsamples prepared in accordance with Step 4.2.1 or sub-section 4.3 using the appropriate subsection(s) in Test Method Q101B (Note 6.3).
- 5.1.2 Test the subsample to determine its moisture content ( $w$ ) in accordance with Test Method AS 1289.2.1.1 or one of the subsidiary Test Methods AS 1289.2.1.2, AS 1289.2.1.4, AS 1289.2.1.5 or AS 1289.2.1.6, for which a relationship with Test Method AS 1289.2.1.1 has been established and used in accordance with Test Method AS 1289.2.3.1.

### **5.2 Compaction subsamples**

- 5.2.1 Screen the subsample over a sieve (screening sieve) equal in aperture size to the maximum particle size to be used in the test in accordance with Test Method Q101H.
- 5.2.2 Process the material passing the screening sieve to ensure that all aggregations of fines or soil clods have been broken up and coatings of fines removed so that, if the subsample was sieved on a 9.50 mm sieve, only discrete uncrushed particles would be retained (Notes 6.6, 6.7, 6.8 and 6.9).
- 5.2.3 If necessary, combine all the material passing the screening sieve using the appropriate subsection in Test Method Q101A.
- 5.2.4 Obtain test portions by further splitting or by fractionation in accordance with Test Method Q101B or Q101C respectively to produce test portions of an appropriate mass from Table 1, unless otherwise specified.
- 5.2.5 Place the prepared test portions in airtight containers.

### **5.3 Coarse test fraction**

Where the test requires test fractions containing uncrushed discrete particles retained on a specified sieve, prepare the subsample as follows:

- 5.3.1 Screen the subsample on the specified sieve (screening sieve) in accordance with Test Method Q101H and discard the material passing the sieve or keep separate for use in other tests if required.
- 5.3.2 Re-sieve the subsample by hand or with a mechanical shaker using the specified sieves in accordance with Test Method Q101H and discard the material passing or include with the passing material from Step 5.3.1.
- 5.3.3 Reduce the retained material if necessary in accordance with Test Method Q101B.
- 5.3.4 Wash the test fraction in accordance with Test Method Q101J.
- 5.3.5 Dry the test fraction as specified in the appropriate Test Method.
- 5.3.6 Reduce the test fraction in accordance with Test Method Q101B to obtain the required test fraction(s).
- 5.3.7 Place the prepared test fraction(s) in an airtight container.

#### **5.4 Fine test fraction**

Where the test requires test fractions containing uncrushed discrete particles passing a specified sieve, prepare the subsamples as follows:

- 5.4.1 Screen the subsample on the specified sieve in accordance with Test Method Q101H.
- 5.4.2 Re-sieve the subsample by hand or with a mechanical shaker using the specified sieves in accordance with Test Method Q101H and discard the retained material or keep the retained separate to be used in other tests if required.
- 5.4.3 Combine the material passing the specified sieve using an appropriate subsection in Test Method Q101A.
- 5.4.4 Reduce the combined material in accordance with Test Method Q101B to obtain the required test fraction(s).
- 5.4.5 Place the prepared test fraction(s) in an airtight container.

#### **5.5 Specified test fraction**

Where the test requires a specified test fraction size or a combination of test fraction sizes, prepare the subsample as follows:

- 5.5.1 Screen the subsample over the smallest sieve specified by the fraction in accordance with Test Method Q101H. Discard the passing material or keep separate to be used in other tests if required.
- 5.5.2 Re-sieve the subsample by hand or with a mechanical shaker using the specified sieves in accordance with Test Method Q101H and discard the material retained on the largest sieve. Discard the material passing the smallest sieve or include with the passing material from Step 5.5.1.
- 5.5.3 Wash the test fraction(s) in accordance with Test Method Q101J.
- 5.5.4 Dry the test fraction(s) as specified in the appropriate test method.
- 5.5.5 Reduce the test fraction(s) in accordance with Test Method Q101B to obtain the required test fraction(s).
- 5.5.6 Place the prepared test fraction(s) in an airtight container.

#### **5.6 Crushed test fraction**

Prepare a crushed test fraction as follows:

- 5.6.1 Crush the subsample to pass the specified sieve using the appropriate subsection in Test Method Q101D (Notes 6.10 and 6.11).
- 5.6.2 Reduce the test fraction in accordance with Test Method Q101B to obtain the required test fraction mass.
- 5.6.3 Place the prepared test fraction in an airtight container.

### **6 Notes on method**

- 6.1 Remove all foreign matter such as roots and sticks from the material during processing. The final report should detail any foreign matter found in the sample.
- 6.2 It is not necessary or desirable to dry the material before commencing preparation. To reduce dust nuisance, it is preferable that splitting be done on a moist sample. However, the material should be sufficiently dry to obtain representative subsamples.

- 6.3 Prepare test subsamples for determination of moisture content 'as received' to minimise any moisture loss during the preparation.
- 6.4 Generally, a mortar and pestle are the most suitable method of cleaning and grinding the Winton Sandstone material retained on the 2.36 mm sieve.
- 6.5 For Winton Sandstone materials pretreatment is required, unless the sample is obtained from a compacted pavement.
- 6.6 Some Test Methods require that the mass of material retained on the screening sieve be recorded and reported. For these methods, record the total mass of retained material and if required, obtain a representative sample for moisture content determination in accordance with Test Method AS 1289.2.1.1.
- 6.7 A sieve other than 9.50 mm may be used. However, an increased sieve aperture will result in an increase in curing time. A decrease in aperture sieve will reduce curing time but can substantially increase preparation time.
- 6.8 For Winton Sandstone material a 2.36 mm sieve should be used.
- 6.9 When preparing moist subsamples which have low to medium plasticity, it is not necessary to remove coatings of fines provided the particles are only lightly coated.
- 6.10 To reduce the preparation time when a subsample has been crushed to totally pass a sieve listed in Table 2, a further subsample may be taken in accordance with an appropriate subsection in Test Method Q101B. Crush this subsample to pass a smaller sieve in Table 2. This process of progressive crushing and subsampling may be continued until the required particle size is obtained.
- 6.11 For preparation of subsamples for chemical testing, Test Method Q101F should be used.

## 7 References

- 7.1 Vanderstaay AGB (May 2000) *Material Sources in Western Queensland, Western Queensland Best Practice Guidelines – WQ33*, Department of Main Roads.

**Table 1 – Approximate mass of representative test portions**

Test method	Mould	Diameter (mm)	Material type	Approximate mass of test portion (g)
Q142A/B	A	105	Heavy clay	2000
			Most soils	2500
			Gravels	3000
Q142A/B	B	152	Heavy clay	5000
			Most soils	6500
			Gravels	7500
Q113A/B/C	CBR	152	Heavy clay	5500
			Most soils	7000
			Gravels	8000
Q125D	A	105	Heavy clay	3000
			Most soils	4000
			Gravels	5000

Test method	Mould	Diameter (mm)	Material type	Approximate mass of test portion (g)
Q136A	A	105	Heavy clay Most soils Gravels	8000 10000 12000
Q136B	Marshall	152.4	Gravels	2700
Q137	RLT	100	Gravels	6000
Q138A/B	Marshall	152.4	Gravels	2700
Q251A/B/C	A	105	Heavy clay Most soils Gravels	8000 10000 12000
Q257	TT	153	Heavy clay Most soils Gravels	9500 10000 12000

**Table 2 - Minimum subsample mass**

Maximum particle size in subsample* (mm)	Minimum mass of subsample (kg)
150	125
100	70
75	40
53	25
37.5	15
26.5	5
19.0	2
9.50	0.5
4.75	0.2
2.36	0.1
0.425	0.05

\*Maximum particle size is identical with the size of the smallest sieve through which the material will pass.

## Test Method Q101A: Sample combination and splitting

### 1 Source

This Test Method was developed in-house using techniques evolved through internal departmental investigations.

### 2 Scope

Obtain representative subsamples by either total sample combination or lot combination. Perform total sample combination when the bulk sample as received is 12 containers or less. Perform lot combination when the bulk sample as received is more than 12 containers.

### 3 Apparatus

Example of sample divider (riffle) is contained in AS 1141.2 Figure 1.

The following apparatus is required:

- 3.1 Increment containers, of a size or so configured that their maximum capacity does not exceed approximately 20 kg.
- 3.2 Labels or tags and marking pens.
- 3.3 Sample divider (riffle), conforming to the requirements of AS 1141.2.
- 3.4 Rotary cone splitter.
- 3.5 Rotary sample divider
- 3.6 Cone and quartering equipment:
  - a) quartering cross (optional)
  - b) shovel, flat bottomed scoop or trowel, and
  - c) brush.

### 4 Riffing

The procedure for riffing shall be as follows:

#### 4.1 Total sample combination (refer to Figure 1)

- 4.1.1 Place a portion of the sample in a riffle box ensuring even distribution, hand placing large particles if necessary (Note 8.1).
- 4.1.2 Split the sample by pouring the material at a uniform rate over the chutes of the riffle, ensuring that no blockages occur and that any oversize particles are divided evenly between the two receiving riffle boxes by hand.
- 4.1.3 If the two receiving boxes contain sufficient material, suspend riffing. Set the two receiving riffle boxes aside, place two empty riffle boxes at the collection points and continue riffing.
- 4.1.4 Repeat Steps 4.1.1 to 4.1.3 until all the material has been split.
- 4.1.5 Keep all the material accumulated at each of the two collection points separate from each other to form two sample increments.
- 4.1.6 Using the riffle, split each sample increment to produce two smaller sample increments, one at each collection point. Keep these smaller sample increments separate from each other.

- 4.1.7 Repeat Step 4.1.6 until such time as the resulting sample increments each comprises only one subsample (that is, one riffle box). The subsamples are now representative (Note 8.1).

#### **4.2 Lot combination**

This procedure has the advantage of dividing the bulk sample into manageable lots or groups.

- 4.2.1 Sort the bulk sample as received into equal lots of similar volume (for example, a bulk sample of 16 containers, 4 lots of 4 containers would be prepared and the containers labelled accordingly).
- 4.2.2 Combine all of the material within a lot (for example, containers 1 to 4 of lot 1) in accordance with subsection 4.1.
- 4.2.3 Place the subsamples produced in the appropriately labelled containers, so that each container contains the same number of sample increments.
- 4.2.4 Repeat Steps 4.2.2 and 4.2.3 for each of the remaining lots.
- 4.2.5 Obtain representative subsamples by combining an equal number of containers from each lot in accordance with subsection 4.1.

### **5 Rotary cone splitter**

This device is suitable for material having a maximum particle size not exceeding 37.5 mm.

The procedure for splitting using a rotary cone shall be as follows:

#### **5.1 Total sample combination (refer to Figure 2)**

- 5.1.1 Place a portion of the sample in the hopper, taking care to ensure that there is no appreciable segregation of material (Note 8.1).
- 5.1.2 Place an increment container at each collection point.
- 5.1.3 Rotate the receivers at a constant speed and allow the hopper to discharge in one operation.
- 5.1.4 Empty the contents of each receiver into its corresponding increment container.
- 5.1.5 Split all the material in accordance with Steps 5.1.1, 5.1.3 and 5.1.4. Each sample increment is now representative.
- 5.1.6 Should smaller subsamples be required, repeat Steps 5.1.1 to 5.1.4 using one or more complete sample increments prepared in Step 5.1.5.

#### **5.2 Lot combination**

This procedure has the advantage of dividing the bulk sample into easily managed lots or groups.

- 5.2.1 Sort the bulk sample as received into equal lots of similar volume (for example, a bulk sample of 48 containers, 4 lots of 12 containers would be prepared and the containers labelled accordingly).
- 5.2.2 Combine all the material within a lot (for example, containers 1 to 12 of lot 1) in accordance with subsection 5.1.
- 5.2.3 Place the sample increments produced in the appropriately labelled containers so that each container contains the same number of whole sample increments.
- 5.2.4 Repeat Steps 5.2.2 and 5.2.3 for each of the remaining lots.

- 5.2.5 Obtain representative subsamples by combining an equal number of containers from each lot in accordance with subsection 5.1.

## **6 Rotary sample divider**

This device is suitable for material having a maximum particle size not exceeding 37.5 mm.

The procedure for splitting using a rotary sample divider shall be as follows:

### **6.1 Total sample combination (refer to Figure 2)**

- 6.1.1 Place a portion of the sample in the hopper, taking care to ensure that there is no appreciable segregation of material (Note 8.1).
- 6.1.2 Place an increment container at each collection point.
- 6.1.3 Adjust the vibratory feeder tray, feed gap, vibration frequency and rotation speed in accordance with the manufacturer's instructions. The feed gap will be set to three times the maximum particle size of the sample.
- 6.1.4 Commence the discharge of material into the receivers. The receivers should rotate at a constant speed until the discharge is completed.
- 6.1.5 Empty the contents of each receiver into its corresponding increment container.
- 6.1.6 Split all the material in accordance with Steps 6.1.1, 6.1.4 and 6.1.5. Each sample increment is now representative.
- 6.1.7 Should smaller subsamples be required, repeat Steps 6.1.1 to 6.1.5 using one or more complete sample increments prepared in Step 6.1.6.

### **6.2 Lot combination**

This procedure has the advantage of dividing the bulk sample into easily managed lots or groups.

- 6.2.1 Sort the bulk sample as received into equal lots of similar volume (for example, a bulk sample of 48 containers, four lots of 12 containers would be prepared and the containers labelled accordingly).
- 6.2.2 Combine all the material within a lot (for example, containers 1 to 12 of lot 1) in accordance with subsection 6.1.
- 6.2.3 Place the sample increments produced in the appropriately labelled containers so that each container contains the same number of whole sample increments.
- 6.2.4 Repeat Steps 6.2.2 and 6.2.3 for each of the remaining lots.
- 6.2.5 Obtain representative subsamples by combining an equal number of containers from each lot in accordance with subsection 6.1.

## **7 Coning and quartering**

Only combine samples by coning and quartering in situations where other procedures are not appropriate.

The procedure for cone and quartering shall be as follows:

- 7.1 Place the material on a clean flat surface and thoroughly mix using a shovel, flat-bottomed scoop, trowel or other suitable apparatus.



- 7.2 Form the material into a cone and then flatten into a circular layer of approximately uniform thickness.
- 7.3 Divide the material into quarters and then gather the diagonally-opposite quarters and mix to form two subsamples. Form each subsample in accordance with Step 7.2.
- 7.4 Repeat Step 7.3 for each subsample until the resultant subsamples are of the required size.

## 8 Notes on method

- 8.1 The minimum mass of material split should ensure the quantity of material collected in each riffle box / receiver is equal to the minimum mass required for a representative subsample in accordance with Table 1. For materials with a maximum particle size larger than 37.5 mm, this rule may not be observed due to capacity of available apparatus.

**Table 1 – Minimum subsample mass**

Maximum particle size in subsample *(mm)	Minimum mass of subsample (kg)
150	125
100	70
75	40
53	25
37.5	15
26.5	5
19.0	2
9.5	0.5
4.75	0.2
2.36	0.1
0.425	0.05

\*Maximum particle size is identical with the size of the smallest sieve through which the material will pass.

Figure 1 – Total sample combination by riffling

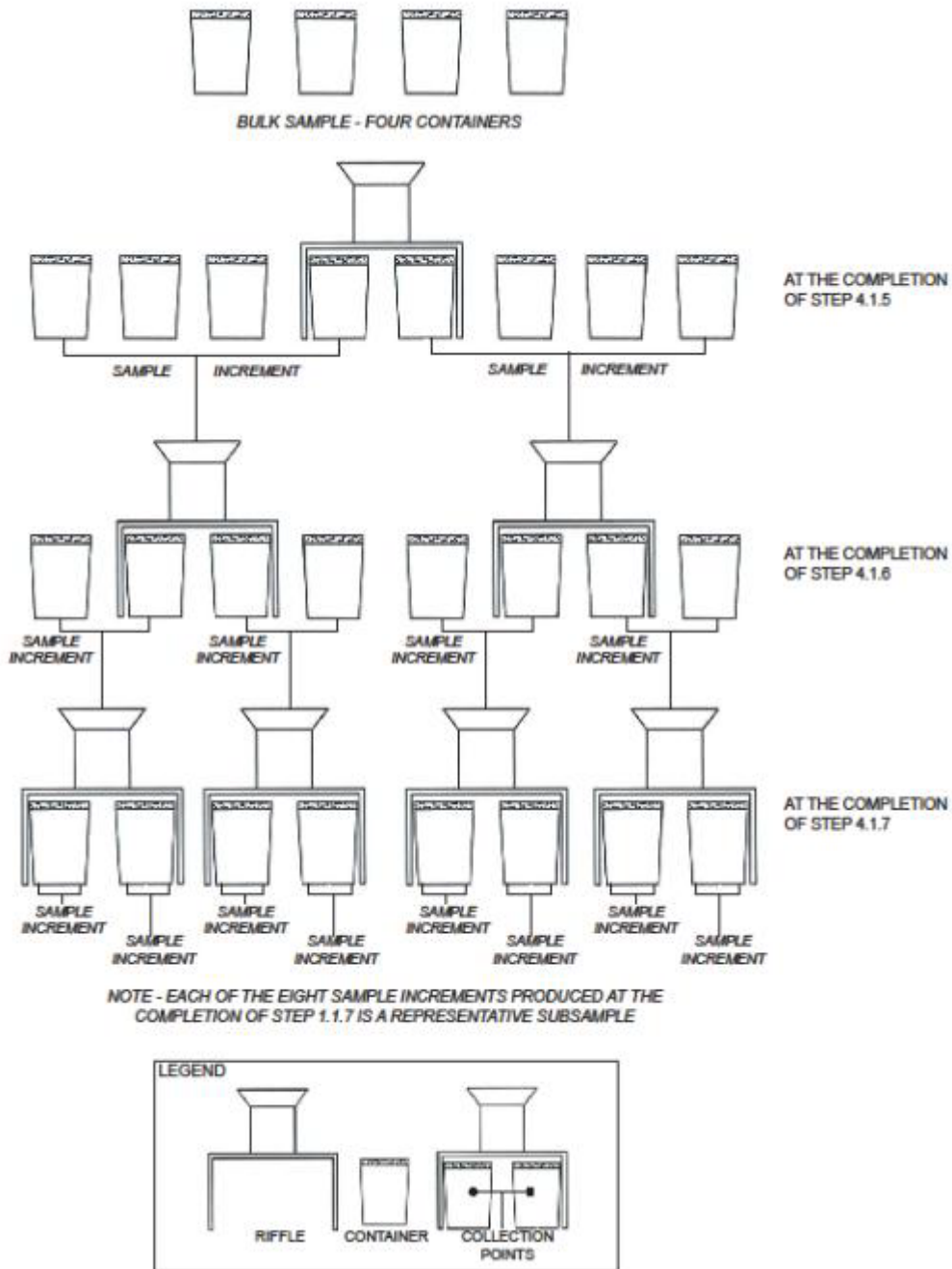
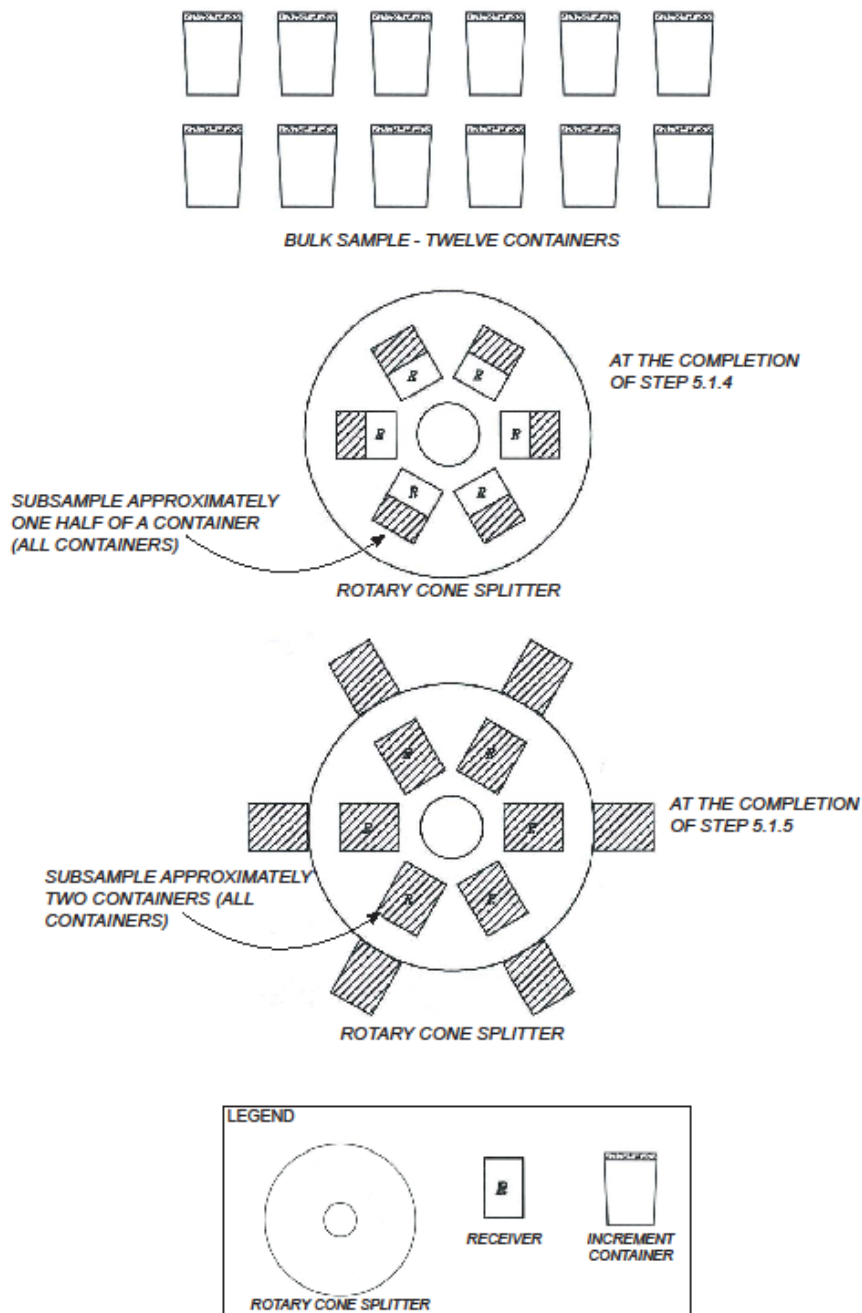

Figure 2 – Total sample combination by rotary cone



## Test Method Q101B: Representative sample reduction

### 1 Source

This Test Method was developed in-house using techniques evolved through internal departmental investigations.

### 2 Scope

Representative test subsamples of approximate, minimum and specified mass are prepared from representative subsamples, obtained from Test Method Q101A where necessary, by splitting using a riffle, rotary cone splitter or rotary sample divider.

### 3 Apparatus

Example of sample divider (riffle) is contained in AS 1141.2 Figure 1.

The following apparatus is required:

- 3.1 Increment containers, of a size or so configured that their maximum capacity does not exceed approximately 20 kg.
- 3.2 Labels or tags and marking pens.
- 3.3 Sample divider (riffle), conforming to the requirements of AS 1141.2.
- 3.4 Rotary cone splitter.
- 3.5 Rotary sample divider.
- 3.6 Flat-bottomed scoop.

### 4 Riffle

The procedure for riffling shall be as follows:

#### 4.1 Approximate/minimum test subsample mass

- 4.1.1 Place a portion of the representative subsample in a riffle box ensuring even distribution, hand placing large particles if necessary.
- 4.1.2 Split the sample by pouring the material at a uniform rate over the chutes of the riffle ensuring that no blockages occur. Divide oversize particles evenly between the two riffle boxes by hand.
- 4.1.3 Repeat Steps 4.1.1 to 4.1.2 until all the material has been split.
- 4.1.4 Repeat Step 4.1.2 using any combination of representative subsamples until the required number of representative test subsamples of the required approximate or minimum mass are obtained.

#### 4.2 Specified test subsample mass

- 4.2.1 Place a portion of the representative subsample in the riffle box ensuring even distribution, hand placing large particles if necessary.
- 4.2.2 Split the sample by pouring the material at a uniform rate over the chutes of the riffle ensuring that no blockages occur. Divide oversize particles evenly between the two riffle boxes by hand.
- 4.2.3 Repeat Steps 4.2.1 and 4.2.2 until the material has been split.

- 4.2.4 Repeat Step 4.2.2 using any combination of representative subsamples until the required number of test subsamples of approximate mass, but less than that specified, have been obtained.
- 4.2.5 Cone and quarter a representative subsample in accordance with Test Method Q101A. Use this subsample as a stock subsample to increase the mass of the subsamples previously obtained at Step 4.2.4.
- 4.2.6 Use a flat-bottomed scoop to obtain a representative subsample from the stock subsample. Add the scooped material to a subsample obtained in Step 4.2.4 until the specified test subsample mass is obtained. At no time is material be added to a test subsample by hand or by pouring from a container.
- 4.2.7 Repeat Step 4.2.6 until all the test subsamples have been brought to the specified mass.

## **5 Rotary cone splitter**

This device is suitable for material having a maximum particle size not exceeding 37.5 mm.

The procedure for splitting using a rotary cone shall be as follows:

### **5.1 Approximate/minimum test subsample mass**

- 5.1.1 Place a portion of the representative subsample in the hopper taking care to ensure that there is no appreciable segregation of material.
- 5.1.2 Place an increment container at each collection point.
- 5.1.3 Rotate the receivers at a constant speed and allow the hopper to discharge in one operation.
- 5.1.4 Empty the contents of each receiver into its corresponding increment container.
- 5.1.5 Repeat Steps 5.1.1, 5.1.3 and 5.1.4 until the whole representative subsample has been split.
- 5.1.6 Repeat Steps 5.1.1 to 5.1.4 using any combination of representative subsamples until the required number of representative test subsamples of the required approximate/minimum mass have been obtained.

### **5.2 Specified test subsample mass**

- 5.2.1 Place a portion of the representative subsample in the hopper taking care to ensure there is no appreciable segregation of material.
- 5.2.2 Place an increment container at each collection point.
- 5.2.3 Rotate the receivers at a constant speed and allow the hopper to discharge in one operation.
- 5.2.4 Empty the contents of each receiver into its corresponding increment container.
- 5.2.5 Repeat Steps 5.2.1, 5.2.3 and 5.2.4 until the whole representative subsample has been split.
- 5.2.6 Repeat Steps 5.2.1 to 5.2.4 using any combination of representative subsamples until the required number of test subsamples of approximate mass, but less than that specified, have been obtained.
- 5.2.7 Cone and quarter a representative subsample in accordance with Test Method Q101A. Use this subsample as a stock subsample to increase the mass of the subsamples previously obtained at Step 5.2.6.

- 5.2.8 Use a flat-bottomed scoop to obtain a representative subsample from the stock subsample. Add the scooped material to a subsample obtained in Step 5.2.6 until the specified test subsample mass is obtained. At no time is material be added to a test subsample by hand or by pouring from a container.
- 5.2.9 Repeat Step 5.2.8 until all the test subsamples have been brought to the specified mass.

## **6 Rotary sample divider**

This device is suitable for material having a maximum particle size not exceeding 37.5 mm.

The procedure for splitting using a rotary sample divider shall be as follows:

### **6.1 Approximate / minimum test subsample mass**

- 6.1.1 Place a portion of the sample in the hopper, taking care to ensure that there is no appreciable segregation of material.
- 6.1.2 Place an increment container at each collection point.
- 6.1.3 Adjust the vibratory feeder tray, feed gap, vibration frequency and rotation speed in accordance with the manufacturer's instructions. The feed gap will be set to three times the maximum particle size of the sample.
- 6.1.4 Commence the discharge of material into the receivers. The receivers should rotate at a constant speed until the discharge is completed.
- 6.1.5 Empty the contents of each receiver into its corresponding increment container.
- 6.1.6 Repeat Steps 6.1.1, 6.1.4 and 6.1.5 until the whole representative subsample has been split.
- 6.1.7 Repeat Steps 6.1.1 to 6.1.5 using any combination of representative subsamples until the required number of representative test subsamples of the required approximate / minimum mass has been obtained.

### **6.2 Specified test subsample mass**

- 6.2.1 Place a portion of the sample in the hopper, taking care to ensure that there is no appreciable segregation of material.
- 6.2.2 Place an increment container at each collection point.
- 6.2.3 Adjust the vibratory feeder tray, feed gap, vibration frequency and rotation speed in accordance with the manufacturer's instructions. The feed gap will be set to three times the maximum particle size of the sample.
- 6.2.4 Commence the discharge of material into the receivers. The receivers should rotate at a constant speed until the discharge is completed.
- 6.2.5 Empty the contents of each receiver into its corresponding increment container.
- 6.2.6 Repeat Steps 6.2.1, 6.2.4 and 6.2.5 until the whole representative subsample has been split.
- 6.2.7 Repeat Steps 6.2.1 to 6.2.5 using any combination of representative subsamples until the required number of test subsamples of approximate mass, but less than that specified, has been obtained.
- 6.2.8 Cone and quarter a representative subsample in accordance with Test Method Q101A. Use this subsample as a stock subsample to increase the mass of the subsamples previously obtained at Step 6.2.7.

- 6.2.9 Use a flat-bottomed scoop to obtain a representative subsample from the stock subsample. Add the scooped material to a subsample obtained in Step 6.2.7 until the specified test subsample mass is obtained. At no time is material be added to a test subsample by hand or by pouring from a container.
- 6.2.10 Repeat Step 6.2.9 until all the test subsamples have been brought to the specified mass.

## Test Method Q101C: Fractionation

### 1 Source

This Test Method was developed in-house using techniques evolved through internal departmental investigations.

### 2 Scope

Representative test subsamples of specified mass are obtained by fractionation. This procedure has application when preparing compaction subsamples and representative subsamples of the total material.

### 3 Apparatus

The following apparatus is required:

- 3.1 Sieves, 37.5 mm, 19.0 mm, 9.50 mm and 4.75 mm conform to ISO 3310, or mechanical apparatus with perforated plate or woven wire mesh of equivalent apertures.
- 3.2 Balance of suitable capacity, having resolution of at least 1 g and a limit of performance within the range of  $\pm 5$  g.

### 4 Procedure

The procedure shall be as follows:

- 4.1 Divide the material into predominately single size fractions by sieving. Recommended size fractions for compaction subsamples are contained in Table 1.
- 4.2 Determine the total mass of each individual fraction ( $M_f$ ).
- 4.3 Calculate the total mass of all individual fractions to be combined as follows:

$$M_t = \sum M_f$$

where  $M_t$  = total mass of all individual fractions to be combined (g)  
 $M_f$  = total mass of individual fraction (g)

- 4.4 Calculate the proportion of each fraction in the subsample as follows:

$$P_f = \frac{M_f}{M_t}$$

where  $P_f$  = proportion of individual fraction in the subsample  
 $M_f$  = total mass of individual fraction (g)  
 $M_t$  = total mass of all individual fractions to be combined (g)

- 4.5 Calculate the mass of each individual fraction to be used to produce a test subsample as follows (Notes 5.1 and 5.2):

$$M_i = M_s P_f$$

where  $M_i$  = mass of individual fraction in the subsample (g)  
 $M_s$  = mass of test subsample (g)



$P_f$  = proportion of individual fraction in the subsample

- 4.6 Where necessary combine all individual fractions of the same size.
- 4.7 Combine the individual subsample fraction masses to form the required test subsample(s) mass (Note 5.3).

**5 Notes on method**

- 5.1 When a test subsample has been specified in terms of dry mass, determine the moisture content (hygroscopic) for each individual fraction in accordance with Test Method AS 1289.2.1.1. This hygroscopic moisture content is used to calculate the required wet mass of each individual fraction in the test subsample. Calculate the wet mass of each of the individual fractions as follows:

$$M_i = M_s P_f \left( 1 + \frac{w}{100} \right)$$

where  $M_i$  = mass of individual fraction in the subsample (g)  
 $M_s$  = mass of test subsample (g)  
 $P_f$  = proportion of individual fraction in the subsample  
 $w$  = hygroscopic moisture content of the individual fraction (%)

- 5.2 Individual fractions should be retained in airtight containers to prevent contamination and moisture variation during storage. Where the individual fractions have been stored for longer than 48 hours, a moisture content determination should be carried out before calculating the fraction masses for a test subsample.
- 5.3 The individual fraction masses may be obtained by using an appropriate procedure detailed in Test Method Q101B.

**Table 1 – Fraction sizes for compaction subsamples**

Size fractions (mm)	
Passing	Retained
37.5	19.0
19.0	9.50
9.50	4.75
4.75	-

## Test Method Q101D: Break-up, cleaning and crushing

### 1 Source

This Test Method was developed in-house using techniques evolved through internal departmental investigations.

### 2 Scope

This Test Method allows for the breaking up of aggregations of fines and soil clods, the removal of coatings of fines from aggregate particles and the crushing of aggregate particles.

The crushing of material for chemical analysis shall be undertaken using Test Method Q101F.

### 3 Apparatus

For break-up and cleaning the following apparatus is required:

- 3.1 Laboratory jaw crusher.
- 3.2 Soil preparation machine (mulcher).
- 3.3 Soil preparation machine (shredder).
- 3.4 Motorised tumbler.
- 3.5 Mortar and rubber pestle.
- 3.6 Wire brush and scraping knife.
- 3.7 Mallet, made of steel, wood or rubber.
- 3.8 Sieves, conforming to ISO 3310 of the following sizes:
  - a) for screening materials, 37.5 mm, 19.0 mm, 6.70 mm, 4.75 mm, 2.36 mm and other sieve sizes as required, and
  - b) for screening crushed materials, 19.0 mm, 6.70 mm, 0.425 mm, 0.075 mm and other sieve sizes as required.

For crushing, the following additional apparatus is required:

- 3.9 Mini-jaw crusher.
- 3.10 Motorised mortar and pestle.
- 3.11 Mortar and pestle, steel or porcelain.
- 3.12 Vibratory disc mill or ring grinder.

### 4 Break-up and cleaning

#### 4.1 Laboratory jaw crusher

Use this apparatus to break up soil clods (Note 6.1):

- 4.1.1 Inspect the feed box, jaws, discharge chute and sample receiver, and clean if necessary.
- 4.1.2 Set the moving jaw to the required gap. When breaking up soil clods it is sometimes necessary to reduce to the required gap by using a number of jaw settings.
- 4.1.3 Start the crusher and progressively feed the material.

4.1.4 Stop the crusher and screen the broken-up material over the appropriate sieve. Pass any oversize soil clods back through the crusher.

4.1.5 Repeat Steps 4.1.3 and 4.1.4 until all the soil clods have been broken up.

#### **4.2 Soil preparation machine (mulcher)**

Use this apparatus to break up soil clods containing gravel and aggregations of fines.

4.2.1 Inspect the receiver and clean if necessary.

4.2.2 Start the machine and progressively feed the material.

4.2.3 Take care not to break any discrete rock particles (Note 6.2). If any breakdown of the rock is evident, it may be necessary to break up the material using a method with less impact in accordance with Subsections 4.4, 4.5 or 4.6.

4.2.4 Repeat Steps 4.2.2 to 4.2.3 until all clods and aggregations are broken up.

#### **4.3 Soil preparation machine (shredder)**

Use this apparatus to break up soil clods and aggregations of fines (Note 6.3).

4.3.1 Inspect the hopper and receiver and clean if necessary.

4.3.2 Start the machine and progressively feed the material.

4.3.3 Using the lever, press the material against the mesh plate to shred the material.

4.3.4 Repeat Steps 4.3.2 to 4.3.3 until all clods and aggregations are broken up.

#### **4.4 Motorised tumbler**

Use this apparatus to break up soil clods and aggregations of fines and to remove coatings of fines from particles.

4.4.1 Inspect the bowl or drum and the charge of steel balls or rods and clean if necessary.

4.5 Place the material in the bowl or drum with a small charge if required. The size of the charge will depend on the capacity of the apparatus and the volume and type of material. Keep the size of the charge as small as possible to prevent break-up of discrete rock particles. It is sometimes unnecessary to use a charge when there is a significant proportion of rock in the material.

4.5.1 Secure the dust cover or lid in place and start the tumbler.

4.5.2 Take care not to break any discrete rock particles (Note 6.2). If any breakdown of the rock is evident, reduce the size of the charge until such time that no breakdown occurs.

4.5.3 Check the material at frequent intervals and sieve when necessary to prevent an accumulation of fines (Note 6.4).

4.5.4 Repeat Steps 4.4.2 to 4.4.5 until all clods and aggregations are broken up and coatings removed.

#### **4.6 Mortar and rubber pestle**

Use the mortar and rubber pestle to break up soil clods and aggregations of fines and to remove coatings of fines from particles. Use the rubber pestle whenever there is any possibility of breaking down low strength discrete particles.

4.6.1 Place sufficient material in the mortar to cover its base.

4.6.2 Grind the material with the pestle returning any ejected material to the mortar.

4.6.3 Take care not to break any discrete rock particles (Note 6.2). If any breakdown of the rock is evident, reduce the pressure exerted on the pestle. Where there is only a minor proportion of these particles, it may be expedient to remove them. Return the particles to the material at the completion of grinding.

#### **4.7 Wire brush and scraping knife**

Use a wire brush and scraping knife to remove coatings of fines from particles (Note 6.2).

#### **4.8 Mallet**

Use a mallet to break up soil clods and aggregations of fines (Notes 6.1 and 6.2).

### **5 Crushing**

#### **5.1 Laboratory jaw crusher or mini-jaw crusher**

5.1.1 Inspect the feed box, jaws, discharge chute and sample receiver, clean if necessary.

5.1.2 Set the moving jaw to the required gap (Note 6.5).

5.1.3 Start the crusher and feed the material at a uniform rate keeping the hopper almost full.

5.1.4 Stop the crusher, collect the crushed material and screen over the appropriate sieve(s).

5.1.5 Adjust the gap between the jaws if necessary and pass the oversize material through the crusher.

5.1.6 Repeat Steps 5.1.2 to 5.1.5 to crush all the material to the required size(s).

#### **5.2 Motorised mortar and pestle**

Use the motorised mortar and pestle to crush rock fragments.

5.2.1 Inspect the equipment and clean if necessary.

5.2.2 Start the motorised mortar and pestle and feed rock fragments into the mortar.

5.2.3 Check the material at frequent intervals and sieve when necessary to prevent an accumulation of fines (Note 6.5).

5.2.4 Repeat Steps 5.2.2 and 5.2.3 to crush all the material to the required size(s).

#### **5.3 Mortar and pestle**

Use a steel mortar and pestle to crush small rocks with a maximum particle size of approximately 37.5 mm. Use the porcelain mortar and pestle to pulverize materials with a maximum particle size of approximately 2.36 mm.

5.3.1 Inspect the mortar and pestle and clean if necessary.

5.3.2 Place sufficient material in the mortar to cover its base. Crush the material returning any ejected material to the mortar.

5.3.3 Sieve the material frequently during the crushing process to prevent an accumulation of fines (Note 6.5).

5.3.4 Repeat Steps 5.3.2 and 5.3.3 to crush all the material to the required size(s).

#### **5.4 Vibratory disc mill or ring grinder**

Use a vibratory disc mill or ring grinder to crush small rock with a maximum particle size of approximately 6.70 mm. They can produce material finer than 0.075 mm.

5.4.1 Inspect the bowl and rings, clean if necessary.

- 5.4.2 Set the mill/grinder to run for an appropriate time (usually 15 seconds is sufficient).
- 5.4.3 Place the rings into the bowl and add material to quarter-half fill the bowl.
- 5.4.4 When the mill/grinder stops, collect the crushed material and screen over the appropriate sieve(s).
- 5.4.5 Return any oversize material to the mill/grinder (Note 6.6).
- 5.4.6 Repeat Steps 5.4.3 to 5.4.5 to crush all the material to the required size(s).

## **6 Notes on method**

- 6.1 This equipment is only suitable for soil clods which are substantially dry and have no appreciable quantity of discrete rock particles which could be crushed and thereby prejudice test results.
- 6.2 Where difficulty exists ascertaining whether particles are discrete or in fact aggregations of fines, place a small number of them in water and boil. If disaggregation occurs, consider such particles as aggregations of fines.
- 6.3 This equipment is only suitable for soil clods that are dry to moist and have no appreciable quantity of discrete rock particles.
- 6.4 The production of an excessive quantity of fines will reduce the effectiveness of the process due to their cushioning effect.
- 6.5 When crushing rock, the general rule is to set the moving jaw gap to half the maximum particle size of the rock to be crushed.
- 6.6 If a small quantity of oversize material remains after grinding and screening, complete the crushing using the mortar and pestle.

## Test Method Q101E: Pre-treatment

### 1 Source

This Test Method applies the principles of Transport for New South Wales Test Methods T102: *Pre-treatment of road construction materials by compaction* and T103: *Pre-treatment of road construction materials by artificial weathering*.

This Test Method includes variations developed through internal departmental investigations (Main Roads 1987) for the treatment of Western Queensland materials such as Winton Sandstone (Vanderstaay 2000).

### 2 Scope

This Test Method sets out the procedure for pre-treating road construction materials by subjecting the material to repeated artificial weathering by cyclic wetting and drying and/or compaction.

The Test Method is appropriate for soft or brittle materials used in earthworks or pavement construction, which are liable to breakdown during winning, compaction and trafficking (for example, shales, siltstones, highly weathered materials, weakly cemented materials soft laminated rock, jointed rock or Winton sandstone).

This Test Method simulates the material breakdown which will occur under construction processes. It would apply to samples taken from prospective or working pits or from material delivered to the roadside, but would not apply to material from the finished earthworks or pavement.

### 3 Apparatus

Where appropriate, the working tolerances of apparatus are contained in Table 1.

Example of rammer is contained in AS 1289.5.1.1, Figure 2.

3.1 For preliminary preparation the following apparatus is required:

- a) Drying oven of suitable capacity, having a temperature of 45-50°C and conforming to AS 1289.0.
- b) Sieve, 53.0 mm and 37.5 mm conforming to ISO 3310.

3.2 For pre-treatment by artificial weathering the following apparatus is required:

- a) Heating device such as an electric hotplate, frypan or gas stove.
- b) Drying oven of suitable capacity, having a temperature of 45-50°C and conforming to AS 1289.0.
- c) Suitable dishes for soaking and drying on a hotplate or in an oven.
- d) Spatula, or other suitable stirring device such as a trowel or flat-bottomed scoop.
- e) Suitable equipment for decanting water from the dishes and collecting the water.
- f) Wire gauze / mesh.
- g) Oven gloves.

3.3 For pre-treatment by compaction the following apparatus is required:

- a) Compaction mould, a cylindrical metal mould having an internal diameter of 150 mm and a minimum internal height of 175 mm, fitted with a detachable baseplate which can be firmly attached to the mould. A split mould may be used.

- b) Rammer, a metal rammer having a 50 mm diameter face, a drop mass of 2700 g and a drop height of 300 mm. Alternatively use a mechanical compactor, provided it meets the essential requirements of drop height, mass and energy input. A mechanical compactor may be used provided the essential dimensions are adhered to and the rammer has a free vertical fall of the correct height with blows being uniformly distributed and in keeping with any prescribed cycle of blows. The design of the compactor allows attachment of the mould to a level and rigid support base. The difference between MDD determinations using manual or mechanical compaction is less than 2%.
- c) Level rigid foundation on which to compact the specimen, for example, a sound concrete floor about 100 mm or more in thickness or a concrete block of at least 100 kg mass.
- d) Sample extractor, such as a jack, lever frame or other device for extruding compacted specimens from the mould when a split mould is not used.
- e) Suitable mixing apparatus, such as a tray, trowel or scoop, mixing machine and water spray suitable for mixing increments of water into the material.
- f) Sealable containers, suitable for storing moist samples.

#### **4 Material**

The following materials are required:

- 4.1 Mould oil, a light oil such as Caltex Mould Oil 20 (Note 10.1).

#### **5 Application**

Where the requirements for pre-treatment is not specified in the appropriate specification, sampling plan or test method, the following shall apply:

- 5.1 Perform pre-treatment by artificial weathering using 10 soaking and drying cycles followed by pre-treatment by compaction using 3 compaction cycles (Note 10.2).
- 5.2 For Winton sandstone (Vanderstaay 2000) perform pre-treatment by compaction only using one compaction cycle.

#### **6 Preparation**

The preparation procedure shall be as follows:

- 6.1 Prepare the sample in accordance with Preliminary Preparation Section 4 of Test Method Q101 to obtain the required number of representative test subsamples.
- 6.2 Further prepare the material by screening the subsamples on a 53.0 mm sieve in accordance with Test Method Q101, Steps 5.2.1 to 5.2.3. Ensure that any aggregations are broken up to pass a 9.5 mm sieve and keep any retained 53.0 mm material.
- 6.3 Determine the approximate percentage retained on the 53.0 mm sieve as follows:

- 6.3.1 Determine the mass of material retained on the 53.0 mm sieve ( $m_{ow}$ ) and the mass of the passing 53.0 mm material ( $m_{uw}$ ). Calculate the wet mass of material as follows:

$$m_w = m_{ow} + m_{uw}$$

- where  $m_w$  = wet mass of material (g)  
 $m_{ow}$  = wet mass of > 53.0 mm material (g)  
 $m_{uw}$  = wet mass of < 53.0 mm material (g)

- 6.3.2 Calculate the percentage material retained on the 53.0 mm sieve as follows:

$$P_{ow} = \frac{100m_{ow}}{m_w}$$

- where  $P_{ow}$  = percentage by wet mass of material retained on the 53.0 mm sieve  
 $m_{ow}$  = wet mass of > 53.0 mm material (g)  
 $m_w$  = wet mass of material (g)

- 6.4 If any material is retained on the 53.0 mm sieve, crush or break this material retained to just pass the 53.0 mm sieve. Recombine this material with the passing 53.0 mm material from Step 6.2 and thoroughly remix.

## 7 Pre-treatment by artificial weathering

The pre-treatment by artificial weathering procedure shall be as follows:

- 7.1 Place the test subsample in the dishes spreading the material evenly over the area of each dish.
- 7.2 Add sufficient water to cover each test subsample.
- 7.3 Allow the test subsamples to stand for at least 16 hours.
- 7.4 After soaking, decant the clear water off the test subsample, taking care not to lose fines during the decanting process. Retain the decanted water for reuse in the subsequent soaking of the test subsample. Avoid the loss of fines that may affect the results in subsequent testing.
- 7.5 Dry the material to a moist, free flowing as follows:
- 7.5.1 For materials containing gypsum or significant amounts of organic matter, place the dish and test subsample in an oven at a temperature not exceeding 80°C.
- 7.5.2 For other materials, cover the dish with wire gauze / mesh and dry the test subsample using a hotplate, stirring frequently to facilitate drying and to prevent overheating of material. Take care not to bake the material after drying is complete. There should be one stirring device per tray to avoid cross-contamination. Stirring device should be cleaned between uses.
- 7.6 The material is deemed to be dry when a clean and dry spatula is inserted and removed from the test subsample and there are no adhering fines or only a fine layer of dust. If material other than dust adheres to the spatula, then continue drying.
- 7.7 Repeat Steps 7.1 to 7.6 until the required soaking and drying cycles have been completed.



- 7.8 Air or oven dry a test subsample which requires drying prior to further preparation or testing. Use a temperature of 45-50°C for oven drying unless otherwise specified in the appropriate test method.

## **8 Pre-treatment by compaction**

The pre-treatment by compaction procedure shall be as follows:

- 8.1 Thoroughly mix the test subsample, adding water so that the material is between OMC and 3% dry of OMC.
- 8.2 Place the test subsample in sealable containers and allow to cure for at least 24 hours.
- 8.3 Remove the material from the container and moisten to approximately OMC, thoroughly mixing the soil and water (Note 10.3).
- 8.4 Compact the material in a lightly oiled mould in approximately three equal layers, 60 mm high when loose, with 75 blows per layer of the standard compaction rammer (Note 10.4).
- 8.5 Remove the compacted material from the mould, crumble the material to break up aggregations and place in a separate container.
- 8.6 Repeat Steps 8.3 to 8.5 until all material in each test subsample has been treated to a complete compaction cycle. Where there is insufficient material remaining to fill the mould, compact the remaining material in one or two approximately equal layers with a loose thickness of 50 to 80 mm per layer.
- 8.7 Repeat Steps 8.3 to 8.6 until each test subsample has been treated to the required number of compaction cycles.
- 8.8 Air or oven dry a test subsample which requires drying prior to further preparation or testing. Use a temperature of 45-50°C for oven drying unless otherwise specified in the appropriate test method.

## **9 Reporting**

The following shall be reported:

- 9.1 Specific pre-treatment procedure(s) used (for example, compaction and/or artificial weathering).
- 9.2 The number of compaction cycles and/or artificial weathering cycles used.
- 9.3 The percent by mass of material retained on the 53.0 mm sieve before pre-treatment to the nearest 1%.
- 9.4 The number of this Test Method, that is Q101E.

## **10 Notes on method**

- 10.1 Before handling oil, the operator should consult the relevant SDS.
- 10.2 The typical pre-treatment using three cycles of compaction and 10 cycles of artificial weathering is contained in Technical Specification MRTS04 *General Earthworks* – Appendix B, April 2017 and the Transport and Main Roads, *Pavement Design Supplement*, Section 5.6.

- 10.3 It is important that the water is thoroughly mixed into and uniformly distributed throughout the material since inadequate mixing gives rise to variable test results. It is desirable to keep the mixed material in a sealed container to allow the water to become more uniformly distributed before compaction.
- 10.4 During compaction, material can build up on the surface of the rammer. This is particularly evident at moisture contents near to and above OMC. To prevent the cushioning effect caused by this build-up, inspect the rammer face and clean, if necessary, during the compaction process.

## 11 References

- 11.1 Main Roads (1987), *Determination of the Liquid Limit of Decomposed Sandstone by the Cone Point Method D07-03-1987*, Barcaldine District, Department of Main Roads.
- 11.2 Vanderstaay AGB (May 2000) *Material Sources in Western Queensland, Western Queensland Best Practice Guidelines – WQ33*, Department of Main Roads.

**Table 1 – Dimensions and tolerances for suitable moulds and rammer**

Apparatus	Dimension	Tolerance
<b>Rammer</b>		
Diameter; round foot (mm)	50	± 0.4
Area of rammer ( $mm^2$ )	1964	± 31
Drop (mm)	300	± 2.0 ‡
Mass (kg)	2.7	± 0.01 ‡
Energy delivered per blow (J)	7.94	± 0.08
Number of layers	3	
Number of blows / layer	60	
Energy input ( $kJ/m^3$ )	596	± 14

‡ Either, but not both, of the tolerances may be exceeded provided that the specified tolerance on energy delivered per blow is not exceeded.

## Test Method Q101F: Crushing

### 1 Source

This Test Method was developed in-house using techniques evolved through internal departmental research investigations.

### 2 Scope

This Test Method describes procedures for crushing subsamples of soil, rock, aggregates or concrete in preparation for various laboratory chemical test methods. It involves the progressive crushing, drying and dividing of a subsample to a final crush finer than a nominated sieve.

### 3 Apparatus

Example of sample divider (riffle) is contained in AS 1141.2, Figure 1.

The following apparatus is required:

- 3.1 Laboratory jaw crusher.
- 3.2 Laboratory mini-jaw crusher.
- 3.3 Vibratory disc mill or ring grinder. Do not use mechanical mills or grinders that generate temperatures in the material in excess of 50°C while operating as they may break down the crystalline structure of the clay minerals.
- 3.4 Sieves, 19.0 mm, 6.70 mm and 0.425 mm conforming to ISO 3310. Other sieve sizes may be specified by the relevant test method.
- 3.5 Sieve brushes.
- 3.6 Drying oven of suitable capacity, having a temperature of 45-50°C and conforming to AS 1289.0.
- 3.7 Sample divider (riffle), conforming to the requirements of AS 1141.2.
- 3.8 Container, of suitable size for drying subsamples.
- 3.9 Suitable container for storing crushed test portion.
- 3.10 Magnet.

### 4 Procedure

The procedure shall be as follows:

#### 4.1 Coarse crushing

- 4.1.1 If the subsample contains no material larger than 6.70 mm, omit the coarse crushing and commence preparation from Step 4.1.3.
- 4.1.2 Crush a representative subsample of the material to pass the 19.0 mm sieve using the jaw crusher as follows:
  - a) Inspect the feed box, jaws, discharge chute and sample receiver and, clean if necessary.
  - b) Set the moving jaw to the required gap (Note 5.1).
  - c) Start the crusher and feed the material at a uniform rate to keep the hopper almost full.
  - d) Stop the crusher, collect the crushed material and screen over the 19.0 mm sieve.

- e) Adjust the gap between the jaws if necessary and pass the oversize material back through the crusher.
  - f) Repeat Steps b) to e) until all the material has been crushed to the required size.
- 4.1.3 Air or oven dry the subsamples that require drying prior to testing. Use the 45-50°C oven unless otherwise specified in the appropriate test method. Allow the subsample to cool to room temperature.
- 4.1.4 Mix and reduce the subsample for medium crushing to a minimum subsample size of 2000 g using a sample divider.
- 4.2 Medium crushing**
- 4.2.1 If the subsample contains no material larger than 4.75 mm, omit the medium crushing and commence preparation from Step 4.2.3.
- 4.2.2 Crush a representative subsample of the material to pass the 6.70 mm sieve using the mini-jaw crusher as follows:
- a) Inspect the feed box, jaws, discharge chute and, sample receiver and clean if necessary.
  - b) Set the moving jaw to the required gap (Note 5.1).
  - c) Start the crusher and feed the material at a uniform rate to keep the hopper almost full.
  - d) Stop the crusher, collect the crushed material and screen over the 6.70 mm sieve.
  - e) Adjust the gap between the jaws if necessary and pass the oversize material back through the crusher.
  - f) Repeat Steps b) to e) until all the material has been crushed to the required size.
- 4.2.3 Air or oven dry the subsamples that require drying prior to testing. Use the 45-50°C oven unless otherwise specified in the appropriate test method. Allow the subsample to cool to room temperature.
- 4.2.4 Mix and reduce the subsample for fine crushing to a minimum subsample size of 750 g using a sample divider.
- 4.2.5 Remove any iron filings produced during the crushing process by passing a magnet over the subsample (Note 5.2).
- 4.3 Fine crushing**
- 4.3.1 Use the 0.425 mm test sieve as the fine screening sieve unless otherwise specified in the relevant test method.
- 4.3.2 Crush the reduced subsample to pass the fine screening sieve using a vibratory disc mill or ring grinder as follows:
- a) Inspect the bowl and crushing rings and clean if necessary.
  - b) Set the crushing time (usually 15 seconds is sufficient).
  - c) Push the crushing rings to one side of the bowl and place no more than 100 g of material in gap between the bowl and the crushing rings.
  - d) Start the mill or grinder and allow it to run for the programmed time.
  - e) Collect the crushed material and screen over the fine screening sieve.
  - f) Repeat Steps c) to e) until all the material passes the fine screening sieve.

- 4.3.3 Remove any iron filings produced during the crushing process by passing a magnet over the subsample (Note 5.2).
- 4.3.4 Air or oven dry the subsamples that require drying prior to testing. Use the 45-50°C oven unless otherwise specified in the appropriate test method. Allow the subsample to cool to room temperature.
- 4.3.5 Store the crushed subsample in a sealed container.

## **5 Notes on method**

- 5.1 When crushing rock, the general rule is to set the moving jaw gap to half the maximum particle size of the rock being crushed.
- 5.2 Omit this step where crushing apparatus with zirconium oxide faces is used.

## Test Method Q101G: Sample blending

### 1 Source

This Test Method was developed in-house using techniques evolved through internal departmental investigations.

### 2 Scope

This Test Method allows for the blending of two or more subsamples based on proportions using either dry mass or loose volume and where necessary, mixing by hand, riffle or mechanical mixer.

### 3 Apparatus

Example of sample divider (riffle) is contained in AS 1141.2, Figure 1.

The following apparatus is required:

- 3.1 Increment containers, of a size or so configured that their maximum capacity does not exceed approximately 20 kg.
- 3.2 Labels or tags and marking pens.
- 3.3 Measuring containers, suitable for volumetric blending. These should be metal and of an appropriate size so that whole containers of material can be measured for blending. For example, the cylindrical measures used in AS 1141.4 have been found to be suitable.
- 3.4 Straightedge, for trimming the top of the measuring container(s).
- 3.5 Mixing apparatus, for example, mixing tray, brush, shovel, scoop or trowel.
- 3.6 Sample divider (riffle), conforming to the requirements of AS 1141.2.
- 3.7 For machine mixing, mechanical mixing equipment, for example, pugmill or catering style dough mixer capable of mixing stabilised portions.
- 3.8 Balances:
  - a) Balance of suitable capacity, having a resolution of at least 1 g and with a limit of performance within the range of  $\pm 5$  g.
  - b) Balance of suitable capacity, having a resolution of at least 0.1 g and with a limit of performance within the range of  $\pm 0.5$  g.

### 4 Procedure

The procedure shall be as follows:

- 4.1 Undertake the blending of material by dry mass in accordance with Subsection 4.2 and the blending of material by loose volume in accordance with Subsection 4.3.
- 4.2 **Blending by dry mass**
  - 4.2.1 Obtain the proportions of each material ( $p_i$ ) and the estimated total dry mass of material required for the relevant test(s) ( $m_t$ ).

4.2.2 Calculate the dry mass of material for each subsample to be blended as follows:

$$m_{di} = m_t p_i$$

where  $m_{di}$  = dry mass of material for each subsample to be blended (g)  
 $m_t$  = estimated total mass of dry material for testing (g)  
 $p_i$  = proportion of each individual material

4.2.3 Calculate the mass of material from each subsample required to produce a subsample with the dry mass calculated in Step 4.2.2 as follows:

$$m_i = \frac{m_{di}(100 + w_i)}{100}$$

where  $m_i$  = mass of material from each subsample (g)  
 $m_{di}$  = dry mass of material for each subsample to be blended (g)  
 $w_i$  = hygroscopic moisture content of material for each subsample to be blended (%)

4.2.4 Reduce each subsample to be blended in accordance with Test Method Q101B to obtain the required mass of material from each subsample ( $m_i$ ) calculated in Step 4.2.3.

4.2.5 Select an even number of empty increment containers so that, when the subsamples are distributed across the increment containers, they are only about one-half to three-quarters full.

4.2.6 Place a portion of the material from each subsample into each increment container ensuring even distribution, hand placing large particles if necessary.

### 4.3 Blending by loose volume

4.3.1 Obtain the proportions of each subsample ( $p_i$ ) and determine the number of measuring containers of each subsample required to obtain the required proportions of each subsample.

4.3.2 Reduce each subsample in accordance with Test Method Q101B to obtain the required volume of subsample, as determined in Step 4.3.1.

4.3.3 Fill the measuring container by pouring the material from the riffle box into the measuring container.

4.3.4 Strike off the surface of the measuring container using the straightedge.

4.3.5 Select an even number of empty increment containers, so that, when the subsamples are distributed across the increment containers, they are only about one-half to three-quarters full.

4.3.6 Place a portion from the measuring container into each increment container ensuring even distribution, hand placing large particles if necessary.

4.3.7 Repeat Steps 4.3.3 to 4.3.6 until the required volume of each subsample is obtained and distributed across the increment containers.

## 5 Mixing

5.1 Mix the material in each increment container, to produce blended test subsamples, by either:

5.1.1 Hand:

a) Spread the contents of the increment container on the mixing tray.

- b) Thoroughly mix to a uniform blend using the scoop or trowel. For coarse materials, this may be done on a floor using a shovel.

5.1.2 Riffle:

- a) Place two empty increment containers at the receiving point of a riffle.
- b) Pour the material at a uniform rate over the chutes of the riffle, ensuring that no blockages occur and that any oversize particles are divided evenly between the two receiving riffle boxes by hand.
- c) Set the two receiving increment containers aside, place two empty receiving containers at the collection points.
- d) Using the two receiving increment containers set aside, repeat the mixing process in Steps 5.1.2 b) to 5.1.2 c) until the contents of the increment container are thoroughly mixed.

5.2 Mix the material in all increments, to produce a representative blended bulk sample, by:

5.2.1 Machine:

- a) Add each increment container to the mixer and mix for 15 seconds to spread the material evenly in the mixer.
- b) After adding the contents of the last increment container, mix the material for 120 seconds to form a uniform blend.
- c) Discharge the mixed material back into the increment containers.

5.2.2 Riffle:

- a) Combine the mixed subsamples using the appropriate subsection in Test Method Q101A.

## 6 Records

The following information shall be recorded:

6.1 For each material in the blend:

- a) Date of sampling.
- b) Material type.
- c) Source of material.
- d) Nominal size (mm).
- e) Sampling location including GNSS reference if required.
- f) Amount of material represented.
- g) Lot identification, sub-lots, field sample numbers, increment numbers.
- h) Name of sampler.
- i) Any other relevant information.

## 7 Reporting

The following shall be reported:

7.1 For each material in the blend:

- a) Material type.



- b) Source of material.
- c) Sampling location.
- d) The proportion of the blend as either a decimal fraction or percentage.

7.2 The number of this Test Method, that is Q101G.

## Test Method Q101H: Sample screening / sieving

### 1 Source

This Test Method was developed in-house using techniques evolved through internal departmental investigations.

### 2 Scope

This Test Method describes procedures for screening / sieving samples of soils or aggregates during preparation.

### 3 Apparatus

The following apparatus is required:

- 3.1 Screen, 10 mm.
- 3.2 Sieves, 37.5 mm, 19.0 mm, 9.50 mm, 4.75 mm and 2.36 mm conforming to ISO 3310.
- 3.3 Mixing apparatus, for example, shovel, scoop or trowel.
- 3.4 Sample containers which prevent fines loss. Containers are to be of a size or so configured that their maximum capacity does not exceed approximately 20 kg.

The following apparatus may be used:

- 3.5 Mechanical sieve shaker.

### 4 Procedure

The procedure shall be as follows:

#### 4.1 Load on sieves

- 4.1.1 Overloading of sieves may affect the accuracy of results and damage the sieves. The maximum loads on sieves at completion of sieving, are set out in Table 1 (Note 5.1). To prevent overloading:
  - a) use sieves with a larger diameter
  - b) use additional sieves, or
  - c) divide the mass retained on the sieve into two or more portions of a mass less than the recommended loading in Table 1 and pass the separate portions through the sieve.

#### 4.2 Screening / sieving

- 4.2.1 Screen the subsample by hand or with a mechanical shaker using the specified sieves as follows:
  - a) Sieving may be performed by hand or with a mechanical shaker. Material retained on 19 mm or larger sieves may be manipulated by hand.
  - b) When sieving is conducted by hand, a lateral and vertical motion is employed accompanied by a slight jarring action to keep the material moving continuously over the sieve. Particles 19.0 mm or larger may be placed by hand to pass the sieves.
  - c) When sieving is conducted using a mechanical sieve shaker, sieving is carried out for such time as will give a comparable result to hand sieving, which is generally 12-15 minutes.

- d) Break up aggregations of fines or soil clods and remove coatings of fines from the retained material by using the appropriate subsection(s) in Test Method Q101D and return all material to the screening sieve.
- e) Continue screening until the mass passing the screening sieve in one minute is less than 1% of the mass of material retained on that sieve.

## 5 Notes on method

- 5.1 The maximum load at the start of sieving should be no more than twice the maximum recommended sieve loading in Table 1. Refer to *Sieve analysis – Different sieving methods for a variety of applications*, Retsch.

**Table 1 – Recommended maximum sieve loadings**

Aperture size (mm)	200 mm diameter (g)	300 mm diameter (g)	450 mm diameter (g)
100	-	3750	7500
75.0	-	3000	6000
37.5	1000	2200	5000
26.5	800	1800	4000
19.0	600	1200	3000
13.2	400	900	4000
9.5	250	600	1500
6.70	225	500	1250
4.75	200	400	1000
2.36	150	300	600
1.18	100	200	400
0.600	75	150	–
0.425	60	120	–
0.300	50	100	–
0.150	40	80	–
0.075	25	50	–

## Test Method Q101J: Sample washing

### 1 Source

This Test Method was developed in-house using techniques evolved through internal departmental investigations.

### 2 Scope

This Test Method describes procedures for washing subsamples of soils or aggregates during preparation. The subsample washing procedures include soaking of materials in either water or dispersing solution and then washing by decanting the suspension over a sieve or transferring all the material to sieves or nested sieves for washing.

### 3 Apparatus

The following apparatus is required:

#### 3.1 Sieves:

- a) Sieves, 37.5 mm, 19.0 mm, 9.50 mm, 4.75 mm and 2.36 mm conforming to ISO 3310 (Note 6.1). Other sieve sizes may be included if specified by a particular Test Method.
- b) Wash sieve, reinforced 0.075 mm sieve.
- c) Guard sieve, usually 4.75 or 2.36 mm to protect sieves finer than 2.36 mm.

#### 3.2 Suitable containers for soaking and washing subsamples.

#### 3.3 Washing sink, with flexible water line, spray nozzle and adjustable flow to deliver water for washing and transfer of subsample. A silt trap may be required to prevent blocking of drains.

The following apparatus may be used:

#### 3.4 Wash colander – bowl with a mesh base for washing coarse materials, legs for supporting the base above the floor of the sink. Mesh with 1-2 mm aperture is suitable.

#### 3.5 Mesh basket, with handle and mesh 1-2 mm aperture is suitable.

#### 3.6 Suitable containers for retaining wash water.

### 4 Materials

The following materials are required:

#### 4.1 Dispersing solution

- Prepare a stock solution by dissolving 33 g of sodium hexametaphosphate (LR Grade) and 7 g of anhydrous sodium carbonate ( $Na_2CO_3$ ) (LR Grade) or 18.9 g of hydrated sodium carbonate ( $Na_2CO_3 \cdot 10H_2O$ ) (LR Grade) in distilled water to make one litre of solution (Note 6.2). This stock solution is diluted to one-tenth strength for use as a washing solution.

#### 4.2 This solution is unstable and is to be freshly prepared approximately once a month with the preparation and expiry dates recorded on the container.

## **5 Procedure**

The procedure shall be as follows:

### **5.1 General**

- 5.1.1 Select the wash sieve / screen required. For a coarse fraction subsample, or specified fraction subsample, this will be the smallest sieve in the fraction. Test Methods will usually specify the wash sieve to be used. For sieves finer than 2.36 mm, a guard sieve may be used to protect the finer mesh from damage.

### **5.2 Soaking – non-cohesive soils or aggregates**

This technique is suitable for most mixes of gravel, sand with trace amounts of silt and/or clay.

- 5.2.1 Place the subsample in a suitable container(s) and fill the container(s) with water until the subsample is covered (Note 6.3). Stir to wet the material and allow to soak for a minimum of ten minutes. The subsample may also be placed in a mesh basket and placed in a container of water such that the subsample is covered.
- 5.2.2 During the soaking period agitate to assist in separation of the particles.

### **5.3 Soaking - cohesive soils**

This technique is suitable for materials with medium to high plasticity fines in more than trace amounts.

- 5.3.1 Place the subsample in a suitable container(s) and fill the container(s) with dispersing solution until the subsample is covered (Note 6.3). Stir to wet the material and allow to soak for a minimum of two hours.
- 5.3.2 During the soaking period, agitate to assist in separation of the particles.

### **5.4 Washing by decanting suspension**

This technique is suitable for materials that do not have significant fines such as concrete aggregates, asphalt aggregates, sprayed surfacing aggregates, natural sands and so on. A wash colander or mesh basket may be used in place of a sieve.

- 5.4.1 After soaking, agitate the contents of the container and pour the suspension into the wash sieve, taking care to prevent overflowing and loss of fines.
- 5.4.2 Wash the material retained on the wash sieve until the wash water becomes clear. Allow the passing the wash sieve material to run to waste (Note 6.4).
- 5.4.3 Add fresh water to the container as required and repeat Steps 5.4.1 and 5.4.2 until the material in the container and that retained on the wash sieve is clean (Notes 6.5 and 6.6).
- 5.4.4 Return all the retained wash sieve material to the container and decant excess water taking care not to lose any of the retained material.

### **5.5 Washing by decanting all material**

This technique is suitable for materials washed over sieves coarser than and including 2.36 mm. A wash colander or mesh basket may be used in place of a sieve, provided the mesh is finer than the washed material to be retained.

- 5.5.1 Using sieves or wash colander
- a) After soaking, agitate the contents of the container and transfer the contents of the container into the wash sieve or colander, taking care to prevent overflowing and loss of material.

- b) Wash the material retained on the wash sieve or colander, using a stream of water, without splashing, until the wash water becomes clear (Notes 6.5 and 6.6). Allow the passing the wash sieve or colander material to run to waste (Note 6.4). During wash, the material may be lightly manipulated by hand to assist washing, taking care not to lose any material. No downward pressure is to be exerted on the material or any forcing of material through the wash sieve or colander.
- c) Return all the washed material to the container, by rinsing the contents retained on the sieve or colander back into the container. This involves inverting the sieve over the container and rinsing the material out of the sieve. Decant excess water from the container taking care not to lose any of the washed material.

#### 5.5.2 Using mesh basket

- a) After soaking, agitate the contents of the mesh basket container and transfer the mesh basket to the washing sink. Empty the container of water that held the mesh basket and rinse clean in the sink.
- b) Wash the material retained in the mesh basket, using a stream of water, without splashing, until the wash water becomes clear (Notes 6.5 and 6.6). Allow the passing the mesh basket material to run to waste (Note 6.4). During wash, the material may be lightly manipulated by hand or the mesh basket may be shaken to assist washing, taking care not to lose any material. No downward pressure is to be exerted on the material or any forcing of material through the wash sieve or colander.
- c) Return all the washed material to the washed container, by rinsing the contents retained in the mesh basket back into the container. This involves inverting the mesh basket over the container and rinsing the material out of the mesh basket. Decant excess water from the container taking care not to lose any of the washed material.

## 6 Notes on method

- 6.1 Because of the ease with which a 0.075 mm sieve can be damaged, the use of a special washing sieve, in which the sieve cloth is reinforced underneath with a coarser sieve or punched plate screen, is recommended.
- 6.2 Before handling sodium hexametaphosphate, anhydrous sodium carbonate or hydrated sodium carbonate, the operator should consult the relevant SDS.
- 6.3 Most materials may be washed without the addition of a dispersing solution. However, soaking in a solution of sodium hexametaphosphate (Calgon) may be necessary if the subsample contains highly plastic fines.
- 6.4 Where the material passing the wash sieve is to be retained for other tests, then a suitable container should be placed under the wash sieve to retain this material.
- 6.5 Water may start accumulating on finer sieves, such as the 0.075 mm, during washing due to clogged apertures. This clogging may cause the overflow of the sieve and loss of material. Lightly hand tapping the side of the sieve can reduce clogging. Directing a stream of water from below the sieve may assist in unclogging the sieve without damaging the sieve.
- 6.6 Care should be taken to avoid overloading finer sieves by washing too large a subsample at a time.

## Test Method Q103A: Particle size distribution of soil – wet sieving

### 1 Source

This Test Method applies the principles of AS 1289.3.6.1: *Determination of the particle size distribution of a soil – Standard method of analysis by sieving*. It differs from this Australian Standard in that only oven dry material is sieved, the passing 2.36 mm portion is washed and differences also occur in reporting requirements and cross-referenced test methods.

### 2 Scope

This Test Method describes the procedure for determining the particle size distribution of soil or crushed rock material, down to the 0.075 mm sieve. The method uses a dry sieving technique in association with washing the passing 2.36 mm material prior to dry sieving.

The Test Method also includes the calculation of properties such as fines ratio ( $FR$ ), fines to sand ratio ( $FSR$ ), % < 0.075 mm / % < 0.300 mm ratio (0.075/0.300), coefficient of uniformity ( $C_u$ ), coefficient of curvature ( $C_c$ ) and grading coefficient ( $G_c$ ) (Notes 9.1 and 9.2).

### 3 Apparatus

The following apparatus is required:

- 3.1 Balance of suitable capacity, having a resolution and a limit of performance in accordance with Table 1 (Note 9.3).
- 3.2 Sieves conforming to ISO 3310 as follows:
  - a) Commonly used sieves include 75.0 mm, 53.0 mm, 37.5 mm, 26.5 mm, 19.0 mm, 9.50 mm, 4.75 mm, 2.36 mm, 0.425 mm and 0.075 mm sieves.
  - b) Other sieve sizes such as 63.0 mm, 6.70 mm, 2.00 mm, 1.18 mm, 0.600 mm, 0.300 mm, 0.212 mm and 0.150 mm may be included to furnish the information required on the material to be tested.
- 3.3 Sieve brushes and a wire or other stiff-bristle brush.
- 3.4 Rubber pestle and steel or ceramic mortar.
- 3.5 Drying oven of suitable capacity, having a temperature of 105-110°C and conforming to AS 1289.0.
- 3.6 Containers, of suitable size, for drying the material.

The following apparatus may be used:

- 3.7 Mechanical sieve shaker.

### 4 Preparation

The sample shall be prepared as follows:

- 4.1 Determine the maximum particle size of the material by assessing the sieve through which all the material will just pass.
- 4.2 Prepare the bulk sample in accordance with Section 4 of Test Method Q101 to obtain a representative subsample that, when dry, will conform to the minimum mass requirements of Table 1.
- 4.3 Determine the mass of the container ( $m_1$ ).

4.4 Place the subsample in the container and dry in the oven to a constant mass ( $m_2$ ).

## 5 Procedure

The subsample shall be sieved as follows:

### 5.1 Load on sieves

Overloading of sieves may affect the accuracy of results and damage the sieves. The maximum loads on sieves at completion of sieving are set out in Table 2 (Note 9.6). To prevent overloading:

- use sieves with a larger diameter, or
- use additional sieves, or
- divide the mass retained on the sieve into two or more portions of a mass less than the recommended loading in Table 2 and pass the separate portions through the sieve.

### 5.2 Methods of sieve shaking

- 5.2.1 Sieving may be performed by hand or with a mechanical shaker. Material retained on 19 mm or larger sieves may be manipulated by hand.
- 5.2.2 When sieving is conducted by hand, a lateral and vertical motion is employed accompanied by a slight jarring action to keep the material moving continuously over the sieve. Particles 19.0 mm or larger may be placed by hand to pass the sieves.
- 5.2.3 When sieving is conducted using a mechanical sieve shaker, sieving is carried out for such time as will give a comparable result to hand sieving, which is generally 12-15 minutes.
- 5.2.4 At the end of sieving, hand sieve each portion retained until the mass passing each sieve in one minute is less than 1% of the mass of material retained on that sieve.

### 5.3 Coarse sieving (particles larger than 19.0 mm)

- 5.3.1 Sieve the subsample through sieves in order of decreasing aperture size down to and including 19.0 mm, using as the largest sieve a size through which all the material just passes and ensuring no sieve is overloaded.
- 5.3.2 Clean the rock particles retained initially on the largest sieve in this coarse sieve series, using the stiff-bristle brush to remove coatings of fines and break up soil clods and aggregations of fines using the pestle and mortar (Note 9.7). Ensure that the resulting fines are passed through the sieve.
- 5.3.3 Sieve the cleaned rock particles by either hand or mechanical shaker.
- 5.3.4 Determine the mass of the particles retained on the sieve ( $m_c$ ).
- 5.3.5 Repeat Steps 6.3.2 to 6.3.4 for each sieve in the coarse series, in order of decreasing size down to and including the 19.0 mm and determine the mass retained on each sieve ( $m_c$ ).

### 5.4 Intermediate Sieving (particles between 19.0 mm and 2.36 mm)

- 5.4.1 Where the subsample has already been coarse sieved in accordance with Steps 6.3.1 to 6.1.5, subsample the material passing 19.0 mm to produce a test portion conforming to minimum mass requirements of Table 1. Place the test portion into a suitable container of known mass ( $m_3$ ). Determine the mass of the test portion and container ( $m_4$ ).
- 5.4.2 Sieve the test portion through the nominated sieves in order of decreasing aperture size down to and including 2.36 mm ensuring no sieve is overloaded (Note 9.8).



- 5.4.3 Clean the rock particles retained on the largest sieve in this intermediate sieve series, using the rubber pestle and mortar to remove coatings of fines and break up soil clods and aggregations of fines (Note 9.6). Ensure the resulting fines collected in the mortar are passed over the sieve.
- 5.4.4 Sieve the cleaned rock particles by either hand or mechanical shaker.
- 5.4.5 Determine the mass of the particles retained on the sieve ( $m_i$ ).
- 5.4.6 Repeat Steps 6.4.3 to 6.4.5 for each sieve in the intermediate series, in order of decreasing size down to and including the 2.36 mm and determine the mass retained on each sieve ( $m_i$ ).

## 5.5 Fine Sieving (particles smaller than 2.36 mm)

- 5.5.1 Where the test portion has already been intermediate sieved in accordance with Steps 6.4.1 to 6.4.6, subsample the material passing 2.36 mm to produce a test portion conforming to minimum mass requirements of Table 1. Place the test portion into a suitable container of known mass ( $m_5$ ). Determine the mass of the test portion and container ( $m_6$ ).
- 5.5.2 Soak and wash the test portion, by decanting the suspension and using a 0.075 mm wash sieve, in accordance with Test Method Q101J (Note 9.9).
- 5.5.3 Place the container with the washed and retained 0.075 mm material in the oven and dry until the material has reached constant mass.
- 5.5.4 Sieve the washed material through the nominated sieves in order of decreasing aperture size down to and including the 0.075 mm by either hand or mechanical shaker. Take care not to apply pressure to the surface of the sieve. Do not use brushes with stiff or worn-down bristles.
- 5.5.5 Determine the mass of the particles retained on each sieve in the fine series ( $m_f$ ).

## 6 Calculations

Calculations shall be as follows:

### 6.1 Coarse Sieving

- 6.1.1 Calculate the cumulative mass retained on each coarse sieve as follows:

$$M_c = \sum m_c$$

- where
- $M_c$  = cumulative mass retained on a coarse sieve (g)
  - $m_c$  = individual mass retained on each coarse sieve with aperture size larger than or equal to the sieve (g)

- 6.1.2 Calculate the cumulative percent retained on each coarse sieve as follows:

$$P_r = \frac{100M_c}{m_2 - m_1}$$

- where
- $P_r$  = cumulative percent retained on a sieve
  - $M_c$  = cumulative mass retained on the sieve (g)
  - $m_1$  = mass of container (g)
  - $m_2$  = mass of container and subsample (g)

6.1.3 Calculate the percent passing each sieve as follows:

$$P_p = 100 - P_r$$

where  $P_p$  = percent passing a sieve  
 $P_r$  = cumulative percent retained on the sieve

## 6.2 Intermediate sieving

6.2.1 Calculate the cumulative mass retained on each intermediate sieve as follows:

$$M_i = \sum m_i$$

where  $M_i$  = cumulative mass retained on an intermediate sieve (g)  
 $m_i$  = individual mass retained on each intermediate sieve with aperture size larger than or equal to the sieve (g)

6.2.2 Where the test portion has been previously coarse sieved and the passing 19.0 mm material subsampled, calculate the cumulative percent retained on each intermediate sieve as follows:

$$P_r = \frac{M_i P_{19.0}}{m_4 - m_3}$$

where  $P_r$  = cumulative percent retained on a sieve  
 $M_i$  = cumulative mass retained on the sieve (g)  
 $m_3$  = mass of container (g)  
 $m_4$  = mass of container and test portion (g)  
 $P_{19.0}$  = percent passing the 19.0 mm sieve

6.2.3 Where the test portion has not been coarse sieved or the passing 19.0 mm material has not been subsampled, calculate the cumulative percent retained on each intermediate sieve as follows:

$$P_r = \frac{100M_i}{m_2 - m_1}$$

where  $P_r$  = cumulative percent retained on a sieve  
 $M_i$  = cumulative mass retained on the sieve (g) (Note 9.8)  
 $m_1$  = mass of container (g)  
 $m_2$  = mass of container and subsample (g)

6.2.4 Where the test portion has been previously coarse sieved and the passing 19.0 mm material subsampled, calculate the percent passing each sieve as follows:

$$P_p = P_{19.0} - P_r$$

where  $P_p$  = percent passing a sieve  
 $P_r$  = cumulative percent retained on the sieve (g)  
 $P_{19.0}$  = percent passing the 19.0 mm sieve

6.2.5 Where the test portion has not been coarse sieved or the passing 19.0 mm material has not been subsampled, calculate the percent passing each sieve as follows:

$$P_p = 100 - P_r$$

where  $P_p$  = percent passing a sieve  
 $P_r$  = cumulative percent retained on the sieve (g)

### 6.3 Fine sieving

6.3.1 Calculate the cumulative mass retained on each fine sieve as follows:

$$M_f = \sum m_f$$

where  $M_f$  = cumulative mass retained on a fine sieve (g)  
 $m_f$  = cumulative mass retained on each fine sieve with aperture size larger than or equal to the sieve (g)

6.3.2 Where the test portion has been previously intermediate sieved and the passing 2.36 mm material subsampled, calculate the cumulative percent retained on each fine sieve as follows:

$$P_r = \frac{M_f P_{2.36}}{m_6 - m_5}$$

where  $P_r$  = cumulative percent retained on a sieve  
 $M_f$  = cumulative mass retained on the sieve (g)  
 $m_5$  = mass of tray (g)  
 $m_6$  = mass of tray and test portion (g)  
 $P_{2.36}$  = percent passing the 2.36 mm sieve

6.3.3 Where the test portion has not been intermediate sieved or the passing 2.36 mm material has not been subsampled, calculate the cumulative percent retained on each fine sieve as follows:

$$P_r = \frac{100M_f}{m_2 - m_1}$$

where  $P_r$  = cumulative percent retained on a sieve  
 $M_f$  = cumulative mass retained on the sieve (g) (Note 9.10)  
 $m_1$  = mass of container (g)  
 $m_2$  = mass of container and subsample (g)

6.3.4 Where the test portion has been previously intermediate sieved and the passing 2.36 mm material subsampled, calculate the percent passing each sieve as follows:

$$P_p = P_{2.36} - P_r$$

where  $P_p$  = percent passing a sieve  
 $P_r$  = cumulative percent retained on the sieve (g)  
 $P_{2.36}$  = percent passing the 2.36 mm sieve

6.3.5 Where the test portion has not been intermediate sieved or the passing 2.36 mm material has not been subsampled, calculate the percent passing each sieve as follows:

$$P_p = 100 - P_r$$

where  $P_p$  = percent passing a sieve  
 $P_r$  = cumulative percent retained on the sieve (g)

## 6.4 Other properties

Calculations may be required, as follows:

6.4.1 Calculate the fines ratio as follows:

$$FR = \frac{P_{0.075}}{P_{0.425}}$$

where  $FR$  = fines ratio  
 $P_{0.075}$  = percent passing the 0.075 mm sieve  
 $P_{0.425}$  = percent passing the 0.425 mm sieve

6.4.2 Calculate the fines to sand ratio as follows:

$$FSR = \frac{P_{0.075}}{P_{2.36}}$$

where  $FSR$  = fines to sand ratio (Notes 9.1 and 9.2)  
 $P_{0.075}$  = percent passing the 0.075 mm sieve  
 $P_{2.36}$  = percent passing the 2.36 mm sieve

6.4.3 Calculate the % < 0.075 mm / % < 0.300 mm ratio as follows:

$$0.075/0.300 = \frac{P_{0.075}}{P_{0.300}}$$

where  $0.075/0.300 = \% < 0.075 \text{ mm} / \% < 0.300 \text{ mm ratio (Note 9.2)}$

$P_{0.075} =$  percent passing the 0.075 mm sieve

$P_{0.300} =$  percent passing the 0.300 mm sieve

6.4.4 For the coefficient of uniformity or the coefficient of curvature, calculate the following particle size values:

a) Calculate the particle size where 60% of particles are smaller as follows:

$$D_{60} = 10^{\left(\log D_2 + \frac{(60 - P_2)(\log D_1 - \log D_2)}{P_1 - P_2}\right)}$$

where  $D_{60} =$  particle size where 60% of particles are smaller (mm)

$\log =$  logarithm to base 10

$D_2 =$  largest sieve with less than 60% passing (mm)

$P_2 =$  percent passing  $D_2$

$D_1 =$  smallest sieve with more than 60% passing (mm)

$P_1 =$  percent passing  $D_1$

b) Calculate the particle size where 10% of particles are smaller as follows:

$$D_{10} = 10^{\left(\log D_2 + \frac{(10 - P_2)(\log D_1 - \log D_2)}{P_1 - P_2}\right)}$$

where  $D_{10} =$  particle size where 10% of particles are smaller (mm)

$\log =$  logarithm to base 10

$D_2 =$  largest sieve with less than 10% passing (mm)

$P_2 =$  percent passing  $D_2$

$D_1 =$  smallest sieve with more than 10% passing (mm)

$P_1 =$  percent passing  $D_1$

c) Calculate the particle size where 30% of particles are smaller as follows:

$$D_{30} = 10^{\left(\log D_2 + \frac{(30 - P_2)(\log D_1 - \log D_2)}{P_1 - P_2}\right)}$$

where  $D_{30}$  = particle size where 30% of particles are smaller (mm)  
 $\log$  = logarithm to base 10  
 $D_2$  = largest sieve with less than 30% passing (mm)  
 $P_2$  = percent passing  $D_2$   
 $D_1$  = smallest sieve with more than 30% passing (mm)  
 $P_1$  = percent passing  $D_1$

6.4.5 Calculate the coefficient of uniformity as follows:

$$C_u = \frac{D_{60}}{D_{10}}$$

where  $C_u$  = coefficient of uniformity  
 $D_{60}$  = particle size where 60% of particles are smaller  
 $D_{10}$  = particle size where 10% of particles are smaller

6.4.6 Calculate the coefficient of curvature as follows:

$$C_c = \frac{D_{30}^2}{D_{10}D_{60}}$$

where  $C_c$  = coefficient of curvature  
 $D_{30}$  = particle size where 30% of particles are smaller  
 $D_{10}$  = particle size where 10% of particles are smaller  
 $D_{60}$  = particle size where 60% of particles are smaller

6.4.7 Calculate the grading coefficient as follows:

$$G_c = \frac{(P_{26.5} - P_{2.00})P_{4.75}}{100}$$

where  $G_c$  = grading coefficient (Note 9.1)  
 $P_{26.5}$  = percent passing the 26.5 mm sieve  
 $P_{2.00}$  = percent passing the 2.00 mm sieve  
 $P_{4.75}$  = percent passing the 4.75 mm sieve

## 7 Reporting

The following shall be reported:

- 7.1 Percent passing each sieve to the nearest 1% for results 10% or greater, and to the nearest 0.1% for results less than 10%.
- 7.2 If required, a semi-logarithmic graph of the sieve size versus the percent passing each sieve.
- 7.3 The number of this Test Method, that is Q103A.

The following may be reported:

- 7.4 Fines ratio to the nearest 0.01 units (if required).
- 7.5 Fines to sand ratio to the nearest 0.01 units.
- 7.6 The % < 0.075 mm / % < 0.300 mm ratio to the nearest 0.01 units.
- 7.7 Coefficient of uniformity to the nearest 0.1 for results 1 or greater and to the nearest 0.01 for results less than 1.
- 7.8 Coefficient of curvature to the nearest 0.1 for results 1 or greater and to the nearest 0.01 for results less than 1.
- 7.9 Grading coefficient to the nearest 0.1 units.

## 8 Notes on method

- 8.1 The following properties are defined in the Australian Road Research Board (2020):
  - a) grading coefficient in Appendix A, Figure A, and
  - b) fines to sand ratio in Appendix A, Table A5.
- 8.2 The following properties are defined in the Kapitzke FJ (2014):
  - a) Fines to sand ratio (% < 0.075 mm / % < 2.36 mm) in Table 2, and
  - b) % < 0.075 mm / % < 0.300 mm in Table 2.
- 8.3 The balance used in the procedure is dependent on the maximum particle size of the test subsample or test portion.
- 8.4 The maximum load at the start of sieving should be no more than twice the maximum recommended sieve loading in Table 2. Refer to Retsch (n.d.) *Sieve analysis – Different sieving methods for a variety of applications*.
- 8.5 Where difficulty exists ascertaining whether particles are discrete or in fact aggregations of fines, obtain some similar particles from the remaining bulk sample. Place these particles in water and bring the water to the boil. If disaggregation occurs, such particles are an aggregation of fines and those in the test portion should be treated accordingly.
- 8.6 Where subsampling of the test portion is omitted following the coarse sieving stage, add the total cumulative mass retained from the coarse sieving stage to each value of  $M_1$ .
- 8.7 Clean granular materials may be washed without the addition of a dispersing solution while cohesive clays may need to be soaked in dispersing solution for several hours.
- 8.8 Where subsampling of the test portion is omitted following both the coarse sieving stage and intermediate sieving stage, add the total cumulative mass retained from the coarse sieving stage and the intermediate sieving stage to each value of  $M_f$ .

## 9 References

- 9.1 Australian Road Research Board (May 2020) *Roads Materials Best Practice Guide 1*
- 9.2 Kapitzke FJ (2014) [Western Queensland Best Practice Guidelines – WQ35 Paving Materials and Type Cross Sections for Roads on Expansive Soils in Western Queensland](#), Department of Transport and Main Roads.

**Table 1 – Test portion and balance requirements**

Maximum particle size (mm)	Minimum test portion mass (g)	Balance resolution (g)	Balance limit of performance range (g)
100	70000	10	± 50
75.0	40000	10	± 50
53.0	25000	10	± 50
37.5	15000	10	± 50
26.5	5000	1	± 5
19.0	2000	1	± 5
9.50	500	0.1	± 0.5
4.75	200	0.1	± 0.5
2.36	100	0.1	± 0.5
0.425	50	0.01	± 0.05

**Table 2 – Recommended maximum sieve loadings**

Aperture size (mm)	200 mm diameter (g)	300 mm diameter (g)	450 mm diameter (g)
100	-	3750	7500
75.0	-	3000	6000
37.5	1000	2200	5000
26.5	800	1800	4000
19.0	600	1200	3000
13.2	400	900	4000
9.5	250	600	1500
6.70	225	500	1250
4.75	200	400	1000
2.36	150	300	600
1.18	100	200	400
0.600	75	150	-
0.425	60	120	-
0.300	50	100	-
0.150	40	80	-
0.075	25	50	-



## Test Method Q104A: Liquid limit of soil

### 1 Source

This Test Method is based on BS 1377-2: *Methods of test for soils for civil engineering purposes – Part 2: Classification tests – Method 4.3: Cone penetrometer method*. However, the liquid limit is defined in this method as the moisture content at a penetration of 15.5 mm. There are some other minor procedural differences.

### 2 Scope

This Test Method describes the procedure for the determination of the liquid limit of the portion of a soil passing the 0.425 mm sieve using the cone penetrometer apparatus. The liquid limit is defined notionally as the moisture content at which the soil passes from the plastic to the liquid state, as determined by this procedure.

### 3 Apparatus

Where appropriate, the working tolerances of apparatus are contained in Table 1.

The following apparatus is required:

- 3.1 Penetrometer, a manual or automatic release penetrometer generally conforming to BS EN 1426, except for the following features:
  - a) Depth indicator, with a resolution, maximum recorded indication error and a maximum recorded repeatability error not exceeding the working tolerances. A device such as a dial gauge conforming to ISO 463 or JIS B 7503, calliper rule conforming to ISO 13385-1 or JIS B 7507, displacement transducer or similar device of at least equal performance to the dial gauge would be suitable (Note 10.1).
  - b) Penetration cone, a polished stainless-steel cone with a cone angle of 30°, and
  - c) The total moving mass of the cone, cone holder, shaft and any adjusting masses is 80 g.
- 3.2 Cone wear template, consisting of a metal plate 1.75 mm thick, with a hole of 1.5 mm diameter.
- 3.3 Sieve, 0.425 mm conforming to ISO 3310.
- 3.4 Mortar and pestle.
- 3.5 Timing device, with a resolution of one second.
- 3.6 Mixing apparatus, such as a mixing bowl (preferably with an airtight lid), spatula and wash bottle.
- 3.7 Oven of suitable capacity, having a temperature of 45-50°C and conforming to AS 1289.0.
- 3.8 Test cups, having an internal diameter of 53 mm and an internal depth of 40 mm. Suitable cups will have a near constant diameter with a smooth rim parallel to a flat base.
- 3.9 Curing containers, airtight containers to be used for curing of samples.
- 3.10 Cloth.

## **4 Materials**

The following materials are required:

- 4.1 Potable water

## **5 Adjustment of apparatus**

Perform the adjustment of the apparatus as follows:

- 5.1 Check that the penetrometer shaft falls freely before each use or on a daily basis.
- 5.2 Check the sharpness of the cone at least daily using the cone wear template. Replace the cone when the point cannot be felt when brushed lightly with a fingertip when the cone is pushed through the hole in the cone wear template.
- 5.3 Check the penetrometer base is level before use.

## **6 Procedure**

The procedure shall be as follows:

- 6.1 Prepare the bulk sample in accordance with Section 4 of Test Method Q101 to produce a representative subsample of appropriate size by either air drying the material or drying in a 45-50°C oven as necessary.
- 6.2 Obtain a representative subsample and further prepare the material in accordance with Subsection 5.4 of Test Method Q101 using a mortar and pestle and screening it on a 0.425 mm sieve to produce a fine test fraction of approximately 300 g of soil fines.
- 6.3 Transfer the fine test fraction to the mixing bowl and using the wash bottle add a small amount of potable water.
- 6.4 Using the spatula, mix the fine test fraction and water thoroughly for several minutes until the mixture becomes a stiff homogeneous paste ready for curing (Note 10.2). A penetration in the range of 9 mm to 12 mm, as determined in Steps 6.7 to 6.17, provides a suitable moisture content for effective curing.
- 6.5 Place the paste in an airtight curing container to cure for at least 12 hours to allow the moisture to permeate the soil.
- 6.6 After curing, mix the cured soil thoroughly for three minutes.
- 6.7 Wipe the interior of the test cup with a damp cloth and fill the test cup by placing the cured soil in the bottom of the test cup, sufficient to more than one-third fill the test cup and exerting adequate pressure on the spatula to displace the cured soil in an outward direction to remove any air from the cured soil.
- 6.8 Continue adding the cured soil to the test cup in this manner until the cured soil is above the level of the test cup rim.
- 6.9 Level the surface of the cured soil with no more than three strokes of the spatula held almost flat.
- 6.10 To prevent moisture loss during testing, place an airtight lid on the mixing bowl or cover with a moist cloth.
- 6.11 Bring the penetrometer shaft and cone to maximum height.
- 6.12 Position the filled test cup centrally under the point of the cone of the penetrometer and bring the point of the cone into contact with the surface of the cured soil.

- 6.13 Zero the penetrometer reading ( $r_1 = 0$ ). For penetrometers that do not have zeroing capability, record initial reading ( $r_1$ ).
- 6.14 Release the penetrometer shaft and allow the cone to penetrate the cured soil for a period of  $5 \pm 1.0$  seconds.
- 6.15 Depress the depth indicator plunger with a light downward pressure and record the depth of penetration of the cone into the cured soil to the nearest 0.1 mm ( $r_2$ ). Determine the cone penetration ( $r_2 - r_1$ ).
- 6.16 Return the penetrometer head to its original position, remove the test cup and clean the penetration cone.
- 6.17 Remove the cured soil from the test cup and add it back into the mixing bowl.
- 6.18 Wipe the test cup clean with a moist cloth and store inverted ready for the next penetration test or use a clean test cup that has had the interior wiped with a damp cloth.
- 6.19 Thoroughly remix the cured soil in the mixing bowl for a period of 30 seconds and repeat Steps 6.7 to 6.18 and determine a second cone penetration.
- 6.20 Compare the two cone penetrations and, if they are within 1.0 mm of each other, then determine the mean penetration. Record this mean as the penetration value ( $p_i$ ). If the two penetrations are not within 1.0 mm of each other, then repeat Steps 6.7 to 6.18.
- 6.21 If the mean penetration is less than 10 mm, add additional water to the cured soil in mixing bowl and thoroughly mix for three minutes. Repeat Steps 6.7 to 6.19 to achieve a mean penetration value between 10-12 mm.
- 6.22 Immediately after the penetration of the second subsample of an acceptable pair of results, remove the cured soil from the test cup and return it to the mixing bowl. Remix the cured soil in the mixing bowl for 30 seconds.
- 6.23 After this remixing, remove about 10-15 g of the cured soil from the mixing bowl and determine the moisture content ( $w_i$ ) in accordance with Test Method AS 1289.2.1.1 (Note 10.3).
- 6.24 Repeat Steps 6.7 to 6.23 four times for successive moisture increments. The moisture increment required such that the first two penetration values of the liquid limit test are less than 14.5 mm, one penetration is between 14.5 mm and 16.5 mm and two penetration values are greater than 16.5 mm. The same penetrometer must be used for the complete liquid limit test. The cured soil shall be thoroughly remixed for a period of three minutes after each moisture increment. The test shall always be performed with the cured soil proceeding from the drier to wetter condition.

## 7 Calculations

Calculate the liquid limit of the soil as follows:

- 7.1 Determine the relationship between the moisture contents ( $w_i$ ) and the penetrations ( $p_i$ ) using linear regression analysis of the following relationship:

$$w = b(\log_{10}p) + a$$

where	$w$	=	moisture content (%)
	$b$	=	slope of linear relationship
	$p$	=	penetration (mm)
	$a$	=	y intercept of linear relationship

7.2 Determine the slope of the linear relationship as follows:

$$b = \frac{n \sum \log_{10} pw - \sum \log_{10} p \sum w}{n \sum \log_{10} p^2 - (\sum \log_{10} p)^2}$$

- where
- $b$  = slope of linear relationship
  - $n$  = number of pairs of test results (5)
  - $\sum \log_{10} pw$  = sum of the products of the corresponding results for the log<sub>10</sub> penetrations ( $p_i$ ) and moisture contents ( $w_i$ )
  - $\sum \log_{10} p$  = sum of the log<sub>10</sub> penetrations ( $p_i$ )
  - $\sum w$  = sum of the moisture contents ( $w_i$ )
  - $(\sum \log_{10} p)^2$  = sum of the squares of the log<sub>10</sub> penetrations ( $p_i$ )

7.3 Determine the y intercept of the linear relationship as follows:

$$a = \frac{1}{n} \left( \sum w - b \sum \log_{10} p \right)$$

- where
- $a$  = y intercept of linear relationship
  - $n$  = number of pairs of test results (5)
  - $\sum w$  = sum of the moisture contents ( $w_i$ )
  - $b$  = slope of linear relationship
  - $\sum \log_{10} p$  = sum of the log<sub>10</sub> penetrations ( $p_i$ )

7.4 Calculate the liquid limit of the soil as follows:

$$w_{CL} = 1.19b + a$$

- where
- $w_{CL}$  = liquid limit of the soil (Note 10.4)
  - $b$  = slope of linear relationship
  - $a$  = y intercept of linear relationship

## 8 Reporting

The following shall be reported:

- 8.1 The liquid limit of the soil to the nearest 0.2%.
- 8.2 The number of this Test Method, that is Q104A.

## 9 Precision

### 9.1 Repeatability

Duplicate tests on the same sample by the same operator are acceptable if the results do not differ by more than  $0.23\sqrt{L}$ , where L is the mean liquid limit for the duplicate tests.

### 9.2 Reproducibility

Duplicate tests on the same sample by different laboratories are acceptable if the results do not differ by more than  $0.94\sqrt{L}$ , where L is the mean liquid limit for the duplicate tests.

## 10 Notes on method

- 10.1 Some devices such as calliper rules (digital or vernier displays) do not require a repeatability assessment in accordance with ISO 13385-1. For such devices, the requirement for repeatability error in Table 1 will not apply.
- 10.2 Inadequate mixing may result in an erroneous value being obtained for the liquid limit (usually less than the true value). This is due to the time required for water to penetrate absorptive particles and into the internal structure of some clays and for mechanical disturbance to break up aggregations of finer particles, particularly clays. The sample should be mixed using a technique of applying firm pressure with the spatula to the paste, against the surface of the bowl, followed by folding of the paste.
- 10.3 This quantity of soil is less than that required by Test Method AS 1289.2.1.1. However, because of the uniformity of the soil that constitutes the sample, it is an acceptable quantity.
- 10.4 The calculation in Step 7.4 has been simplified from  $w = b(\log_{10}15.5) + a$ .

**Table 1 – Working tolerances for apparatus**

Apparatus	Value	Tolerance
<b>Penetrometer - depth indicator</b>		
Resolution (mm)	0.1	Maximum
Indication error (mm)	0.0	± 0.2
Repeatability error (mm)	0.0	± 0.05
<b>Penetration cone</b>		
Cone angle (degrees)	30	± 1
<b>Cone, cone holder and shaft</b>		
Mass (g)	80	± 0.1
<b>Cone wear template</b>		
Thickness (mm)	1.75	± 0.1
Hole diameter (mm)	1.5	± 0.05
<b>Test cup</b>		
Internal diameter (mm)	53	Minimum
Internal depth (mm)	40	Minimum

## Test Method Q104D: Liquid limit of soil - one point

### 1 Source

This Test Method is based on BS 1377-2: Methods of test for soils for civil engineering purposes – Part 2: Classification tests – Method 4.4: One-point cone penetrometer method. However, the liquid limit is defined in this Test Method as the moisture content at a penetration of 15.5 mm, thus the factor calculated in Step 6.1 will be different from the source method. There are some other minor procedural differences.

This Test Method also includes variations developed through internal departmental investigations (Main Roads 1987) to allow the testing of Winton sandstone material (Vanderstaay 2000).

### 2 Scope

This method describes a one-point procedure for the determination of the liquid limit of the portion of a soil passing the 0.425 mm sieve using the cone penetrometer apparatus.

This method is less accurate than the standard method described in Test Method Q104A. In the case of any doubts when using this method, the sample should be retested using Test Method Q104A (except for Winton Sandstones, which cannot be tested using Test Method Q104A).

### 3 Apparatus

Where appropriate, the working tolerances of apparatus are contained in Table 1.

The following apparatus is required:

- 3.1 Penetrometer, a manual or automatic release penetrometer generally conforming to BS EN 1426, except for the following features:
  - a) Depth indicator, with a resolution, maximum recorded indication error and a maximum recorded repeatability error not exceeding the working tolerances. A device such as a dial gauge conforming to ISO 463 or JIS B 7503, calliper rule conforming to ISO 13385-1 or JIS B 7507, displacement transducer or similar device of at least equal performance to the dial gauge would be suitable (Note 9.1).
  - b) Penetration cone, a polished stainless steel cone with a cone angle of 30°.
  - c) The total moving mass of the cone, cone holder, shaft and any adjusting masses is 80 g.
- 3.2 Cone wear template, consisting of a metal plate 1.75 mm thick, with a hole of 1.5 mm diameter.
- 3.3 Sieve, 0.425 mm conforming to ISO 3310.
- 3.4 Mortar and pestle.
- 3.5 Timing device, a stopwatch or audible seconds counter accurate to 0.5 seconds.
- 3.6 Mixing apparatus, such as a mixing bowl (preferably with an airtight lid), spatula and wash bottle.
- 3.7 Oven of suitable capacity, having a temperature of 45-50°C and conforming to AS 1289.0.
- 3.8 Test cup, having an internal diameter of 53 mm and an internal depth of 40 mm. Suitable cups will have a near constant diameter with a smooth rim parallel to a flat base.
- 3.9 Curing containers, airtight containers to be used for curing of samples.

3.10 Cloth.

#### **4 Materials**

The following materials are required:

4.1 Potable water.

#### **5 Adjustment on apparatus**

Perform the adjust of the apparatus as follows:

5.1 Check that the penetrometer shaft falls freely before each use or on a daily basis.

5.2 Check the sharpness of the cone at least daily using the cone wear template. Replace the cone where the point cannot be felt when brushed lightly with a fingertip when the cone is pushed through the hole in the cone wear template.

5.3 Check the penetrometer base is level before use.

#### **6 Procedure**

The procedure shall be as follows:

##### **6.1 For materials other than Winton Sandstone:**

6.1.1 Prepare the bulk sample in accordance with Section 4 of Test Method Q101 to produce a representative subsample of appropriate size by either air drying the material or drying in a 45-50°C oven as necessary.

6.1.2 Obtain a representative subsample and further prepare the material in accordance with Subsection 5.4 of Test Method Q101 using a mortar and pestle and screening it on a 0.425 mm sieve to produce a fine test fraction of approximately 150 g of soil fines.

6.1.3 Transfer the fine test fraction to the mixing bowl and, using the wash bottle, add a small amount of potable water.

6.1.4 Using the spatula, mix the fine test fraction and water thoroughly for several minutes until the mixture becomes a stiff homogeneous paste ready for curing (Note 9.2). A penetration in the range of 9 mm to 21 mm, as determined in Steps 6.1.7 to 6.1.17, provides suitable moisture content for effective curing.

6.1.5 Place the paste in an airtight curing container to cure for at least 12 hours to allow the moisture to permeate the soil.

6.1.6 After curing, mix the cured soil thoroughly for three minutes.

6.1.7 Wipe the interior of the test cup with a damp cloth and fill the test cup by placing the cured soil in the bottom of the test cup, sufficient to more than one-third fill the container and exerting adequate pressure on the spatula to displace the cured soil in an outward direction to remove any air from the cured soil.

6.1.8 Continue adding the cured soil to the test cup in this manner until the cured soil is above the level of the test cup rim.

6.1.9 Level the surface of the cured soil with no more than three strokes of the spatula held almost flat.

6.1.10 To prevent moisture loss during testing, place an airtight lid on the mixing bowl or cover the mixing bowl with a moist cloth.

- 6.1.11 Bring the penetrometer shaft and cone to maximum height.
- 6.1.12 Position the filled test cup centrally under the point of the cone of the penetrometer and bring the point of the cone into contact with the surface of the cured soil.
- 6.1.13 Zero the penetrometer reading ( $r_1 = 0$ ). For penetrometers that do not have zeroing capability record initial reading ( $r_1$ ).
- 6.1.14 Release the penetrometer shaft and allow the cone to penetrate the cured soil for a period of  $5 \pm 1.0$  seconds.
- 6.1.15 Depress the indicator plunger with a light downward pressure and record the depth of penetration of the cone into the cured soil to the nearest 0.1 mm ( $r_2$ ). Determine the cone penetration ( $r_2 - r_1$ ).
- 6.1.16 Return the penetrometer head to its original position, remove the test cup and clean the penetration cone.
- 6.1.17 Remove the cured soil from the test cup and add it back into the mixing bowl.
- 6.1.18 Wipe the test cup clean with a moist cloth and store inverted ready for the next penetration test or use a clean test cup that has had the interior wiped with a damp cloth.
- 6.1.19 Thoroughly remix the cured soil in the mixing bowl for a period of 30 seconds and repeat Steps 6.1.76 to 6.1.18 and determine a second cone penetration.
- 6.1.20 Compare the two cone penetrations and, if they are within 1.0 mm of each other and the mean penetration is within the 10-21 mm range, then the mean result may be determined ( $p$ ). Record this mean as the penetration value. If the two penetrations are not within 1.0 mm of each other, then repeat Steps 6.1.7 to 6.1.18.
- 6.1.21 If the mean penetration is less than 10 mm, add additional water to the cured soil and thoroughly mix for three minutes. Repeat Steps 6.1.7 to 6.1.18 to achieve a mean penetration value between 10-21 mm.
- 6.1.22 Immediately after the penetration of the second subsample of an acceptable pair of results, remove the cured soil from the test cup and return it to the mixing bowl. Remix the cured soil in the mixing bowl for 30 seconds.
- 6.1.23 After this remixing, remove about 10-15 g of the cured soil from the mixing bowl and determine the moisture content ( $w$ ) in accordance with Test Method AS 1289.2.1.1 (Note 9.3).

**6.2 For Winton Sandstone materials (Note 9.4):**

- 6.2.1 Prepare the sample in accordance with Section 4 of Test Method Q101 to produce a representative subsample of appropriate size by either air drying the material or drying in a 45-50°C oven as necessary.
- 6.2.2 Obtain a representative subsample and further prepare the material in accordance with Subsection 5.4 of Test Method Q101 using a mortar and pestle and screening it on a 0.425 mm sieve to produce a fine test fraction of approximately 200 g of soil fines.
- 6.2.3 Transfer the fine test fraction to the mixing bowl and add potable water (Note 9.3).
- 6.2.4 Using the spatula, mix the fine test fraction and water thoroughly for five minutes (Note 9.1). The addition of small increments of water to facilitate mixing is permitted provided the total mixing time remains five minutes.
- 6.2.5 Place the mixture in an airtight curing container to cure for at least 12 hours to allow the moisture to permeate the soil.



- 6.2.6 After curing, mix the cured soil thoroughly for 10 minutes.
- 6.2.7 Wipe the interior of the test cup with a damp cloth and fill the test cup by placing the cured soil in the bottom of the test cup, sufficient to more than one-third fill the container and exerting adequate pressure on the spatula to displace the cured soil in an outward direction to remove any air from the cured soil.
- 6.2.8 Continue adding the cured soil to the test cup in this manner until the cured soil is above the level of the test cup rim.
- 6.2.9 Level the surface of the cured soil with only one stroke of the spatula held almost flat.
- 6.2.10 To prevent moisture loss during testing, place an airtight lid on the mixing bowl or cover with a moist cloth.
- 6.2.11 Bring the penetrometer shaft and cone to maximum height.
- 6.2.12 Position the filled test cup centrally under the point of the cone of the penetrometer and bring the cone into contact with the surface of the cured soil.
- 6.2.13 Zero the penetrometer reading ( $r_1 = 0$ ). For penetrometers that do not have zeroing capability, record initial reading ( $r_1$ ).
- 6.2.14 Release the penetrometer shaft and allow the cone to penetrate the cured soil for a period of  $5 \pm 1.0$  seconds.
- 6.2.15 Depress the depth indicator plunger with a light downward pressure and record the depth of penetration of the cone into the cured soil to the nearest 0.1 mm ( $r_2$ ). Determine the cone penetration ( $r_2 - r_1$ ).
- 6.2.16 Return the penetrometer head to its original position, remove the test cup and clean the penetration cone.
- 6.2.17 Discard the cured soil in the test cup.
- 6.2.18 Wipe the test cup clean with a moist cloth and store inverted ready for the next penetration test or use a clean test cup that has had the interior wiped with a damp cloth.
- 6.2.19 Repeat Steps 6.2.8 to 6.2.18 and determine a second cone penetration.
- 6.2.20 Compare the two cone penetrations and, if they are within 1.0 mm of each other and the mean penetration is within the 10-21 mm range, then the mean may be determined ( $p$ ).
- 6.2.21 Record this mean as the penetration value. If the two penetrations are not within 1.0 mm of each other or outside the 10-21 mm range, then discard the cured soil and repeat the entire test.
- 6.2.22 Immediately after the penetration of the second subsample of an acceptable pair of results, remix the cured soil in the mixing bowl for 30 seconds.
- 6.2.23 After this remixing, remove about 10-15 g of the cured soil from the mixing bowl and determine the moisture content ( $w$ ) in accordance with Test Method AS 1289.2.1.1 (Note 9.3).

## 7 Calculation

- 7.1 Calculate the correction factor for penetration value as follows:

$$f = 2.1261p^{-0.2752}$$

- where  $f$  = correction factor for penetration value of the sample  
 $p$  = mean penetration value (mm)

7.2 Calculate the liquid limit of the soil as follows:

$$w_{CL} = wf$$

where  $w_{CL}$  = liquid limit of the soil (%)  
 $w$  = moisture content of soil  
 $f$  = correction factor for penetration value of the sample

## 8 Reporting

The following shall be reported:

- 8.1 Liquid limit of the soil to the nearest 0.2%.
- 8.2 If the material tested is Winton Sandstone, this should be reported.
- 8.3 The number of this Test Method, that is Q104D.

## 9 Notes on method

- 9.1 Some devices such as calliper rules (digital or vernier displays) do not require a repeatability assessment in accordance with ISO 13385-1. For such devices, the requirement for repeatability error in Table 1 will not apply.
- 9.2 Inadequate mixing may result in an erroneous value being obtained for the liquid limit (usually less than the true value). This is due to the time required for water to penetrate into absorptive particles and into the internal structure of some clays and for mechanical disturbance to break up aggregations of finer particles, particularly clays. The sample should be mixed using a technique of applying firm pressure with the spatula to the paste, against the surface of the bowl, followed by folding of the paste.
- 9.3 This quantity of soil is less than that required by Test Method AS 1289.2.1.1. However, because of the uniformity of the soil that constitutes the sample, it is considered an acceptable quantity.
- 9.4 The mixing times specified in Steps 6.2.4 and 6.2.6 need to be strictly adhered to for Winton Sandstone. Variations in mixing time can significantly affect the results.
- 9.5 The water added should be sufficient to produce the desired consistency slightly stiffer than liquid limit at the conclusion of mixing.

## 10 References

- 10.1 Main Roads (1987), *Determination of the Liquid Limit of Decomposed Sandstone by the Cone Point Method D07-03-1987*, Barcaldine District, Department of Main Roads
- 10.2 Vanderstaay AGB (May 2000) *Material Sources in Western Queensland, Western Queensland Best Practice Guidelines – WQ33*, Department of Main Roads.

**Table 1 – Working tolerances for apparatus**

<b>Apparatus</b>	<b>Value</b>	<b>Tolerance</b>
<b>Penetrometer - depth indicator</b>		
Resolution (mm)	0.1	Maximum
Indication error (mm)	0.0	± 0.2
Repeatability error (mm)	0.0*	± 0.05
<b>Penetration cone</b>		
Cone angle (°)	30	± 1
<b>Cone, Cone holder and shaft</b>		
Mass (g)	80	± 0.1
<b>Cone wear template</b>		
Thickness (mm)	1.75	± 0.1
Hole diameter (mm)	1.5	± 0.05
<b>Test receptacles</b>		
Internal diameter (mm)	53	Minimum
Internal depth (mm)	40	Minimum

## Test Method Q105: Plastic limit and plasticity index of soil

### 1 Source

This Test Method is based on AS 1289.3.2.1: Soil classification tests – Determination of the plastic limit of a soil – Standard method and AS 1289.3.3.1: Soil classification tests – Calculation of the plasticity index of a soil except as follows:

- a) when determining plastic limit, the sample is initially prepared to an oven or air dried condition
- b) for compliance testing required by Transport and Main Roads technical specifications the sample is then brought to a moisture content higher than the liquid limit before commencing
- c) rolling of soil threads between the hands is not permitted
- d) the definition of the endpoint where the soil thread reaches the plastic limit differs from the source method, and
- e) for the plasticity index, the calculation is based on a liquid limit determined using a cone penetrometer.

### 2 Scope

This Test Method describes the procedure for the determination of the plastic limit of the portion of a soil passing the 0.425 mm sieve. The plastic limit is the moisture content at which the soil passes from the semisolid to the plastic state as determined in accordance with this standard procedure.

The plasticity index is the numerical difference between the liquid limit and plastic limit and is a measure of the range over which the soil is notionally considered to be in the plastic state.

### 3 Definitions

For this Test Method the following definition shall apply:

- 3.1 Weighted plasticity index (WPI) - is defined as the product of the plasticity index (PI) of a soil and the percentage of the soil finer than 0.425 mm.

### 4 Apparatus

Where appropriate, the working tolerances of apparatus are contained in Table 1.

The following apparatus is required:

- 4.1 Glass plate, about 300 mm square, 10 mm thick, either ground glass or lightly sand blasted.
- 4.2 Containers with lids, for moisture content determination.
- 4.3 Reference rod, 3.0 mm diameter and approximately 90 mm long.

### 5 Determination of plastic limit

The procedure shall be as follows:

- 5.1 Obtain approximately 50 g of the soil/water mixture used in the liquid limit test (Q104A or Q104D) at the first mean penetration greater than or equal to 15.5 mm.
- 5.2 Form a subsample of about 10 g into a ball and cover the remaining material to avoid evaporation.

- 5.3 Roll the subsample between the fingers and the glass plate. Use sufficient finger pressure to reduce the diameter of the subsample (Note 9.1).
- 5.4 When the length of the thread is approximately 90 mm long, divide the thread into three or four equal lengths as excessively long threads become unwieldy and break apart. Cover the threads to avoid evaporation.
- 5.5 Roll each thread in turn between the fingers and the glass plate. Use sufficient finger pressure to reduce the diameter of the thread to 3 mm when compared to the reference rod. If the thread reaches 3 mm without crumbling, cover the thread to avoid further moisture loss. If at any time during the rolling process the soil thread crumbles or ceases to roll before the diameter reaches 3 mm, the soil thread is at the plastic limit and the test continued from Step 5.8 (Notes 9.2 and 9.3).
- 5.6 Roll all threads to a 3 mm diameter and then knead them together and reform into a ball.
- 5.7 Repeat the process of rolling and kneading as described in Steps 5.4 to 5.6 until crumbling of the soil thread occurs (Note 9.4).
- 5.8 As each soil thread reaches the plastic limit, place it in a container for moisture determination and replace the lid.
- 5.9 Repeat Steps 5.3 to 5.8 until at least 10 g of soil has been placed in the container. Determine the moisture content ( $w_1$ ) of the test portion in accordance with Test Method AS 1289.2.1.1 (Note 9.5).
- 5.10 Repeat Steps 5.2 to 5.9 for a second determination of the plastic limit of the soil ( $w_2$ ).

## 6 Calculations

Calculations shall be as follows:

- 6.1 Calculate the plastic limit as follows:

$$w_P = \frac{w_1 + w_2}{2}$$

where

- $w_P$  = plastic limit of the soil
- $w_1$  = moisture content of first test portion (%)
- $w_2$  = moisture content of second test portion (%)

- 6.1.1 Compare the individual moisture contents and, if they vary by more than  $0.43\sqrt{w_P}$  where  $w_P$  is the plastic limit, then repeat the test.

- 6.2 Calculate the plasticity index as follows:

$$I_{CP} = w_{CL} - w_P$$

where

- $I_{CP}$  = plasticity index of the soil (Note 9.6)
- $w_{CL}$  = reported liquid limit of the soil, obtained from either Test Method Q104A or Q104D (%)
- $w_P$  = plastic limit of the soil (%)

6.3 If required, calculate the weighted plasticity index as follows:

$$WPI = I_{CP} \cdot P_{0.425}$$

where  $WPI$  = weighted plasticity index of the soil (%)  
 $I_{CP}$  = plasticity index of the soil (%)  
 $P_{0.425}$  = percentage passing the 0.425 mm sieve, obtained from Test Method Q103A

## 7 Reporting

The following shall be reported:

- 7.1 Plasticity index to the nearest 0.2%, and
- 7.2 The number of this Test Method, that is Q105.

The following may be reported:

- 7.3 Plastic limit to the nearest 0.2%, and
- 7.4 Weighted plasticity index to the nearest 1% (if required).

## 8 Precision

### 8.1 Repeatability

#### 8.1.1 Plastic Limit

Duplicate tests by the same operator are acceptable if they do not differ by more than  $0.31\sqrt{w_P}$ , where  $w_P$  is the mean plastic limit for the duplicate tests.

#### 8.1.2 Plasticity Index

Duplicate tests by the same operator are acceptable if the results do not differ by more than  $0.31\sqrt{I_{CP}}$ , where  $I_{CP}$  is the mean plasticity index for the duplicate tests.

### 8.2 Reproducibility

#### 8.2.1 Plastic Limit

Duplicate tests from different laboratories are acceptable if they do not differ by more than  $1.73\sqrt{w_P}$ , where  $w_P$  is the mean plastic limit for the duplicate tests.

#### 8.2.2 Plasticity Index

Duplicate tests from different laboratories are acceptable if the results do not differ by more than  $1.82\sqrt{I_{CP}}$ , where  $I_{CP}$  is the mean plasticity index for the duplicate tests.

## 9 Notes on method

- 9.1 For highly plastic soils, it may not be possible to roll the soil/water mixture because of its high moisture content. Should this be the case, spread the soil on the glass plate to facilitate drying at room temperature and remix thoroughly at regular intervals to ensure even distribution of moisture. Use mixing techniques such as heavy kneading and hand mixing to facilitate drying. Continue the drying and mixing until the soil can be rolled.
- 9.2 Crumbling will manifest itself differently for various types of soil. Some soils fall apart in numerous small aggregations of particles; others may form an outside tubular layer that starts splitting at both ends. The splitting progresses towards the middle and finally the thread falls apart in numerous small platy particles.

- 9.3 Some soils show a tendency to crumble or cease to roll prematurely due to excessive pressure. Premature crumbling can also be due to planes formed in the soil mass while kneading it. It is important that the soil thread crumbles or ceases to roll due to decreasing moisture content only. The operator should therefore ensure that the soil thread is truly homogeneous with no planes or fissures in it and that the pressure exerted is just sufficient to diminish the diameter of the thread without distorting it. Oblique rolling can also cause premature crumbling of the soil thread and take care to ensure that the rolling force is normal to the axis of the thread.
- 9.4 The plastic limit test is liable to a significant amount of personal variation and operators require a great deal of practice before they get the 'feel' for all soils and can determine the endpoint accurately. Follow the procedure detailed in this method to eliminate all possible personal sources of variation.
- 9.5 The quantity of soil is less than that required by Test Method AS 1289.2.1.1. However, because of the uniformity of the soil that constitutes the sample, it is an acceptable quantity.
- 9.6 If the plastic limit is greater than the liquid limit, record the plasticity index as zero.

**Table 1 – Working tolerances for apparatus**

<b>Apparatus</b>	<b>Dimension</b>	<b>Tolerance</b>
<b>Reference rod</b>		
Diameter (mm)	3.0	± 0.3

## Test Method Q106: Linear shrinkage of soil

### 1 Source

This Test Method applies the principles of AS 1289.3.4.1 – Determination of the linear shrinkage of a soil – Standard method. It differs from this Australian Standard in the cross-sectional shape of the mould, trimming technique, drying requirements, technique for measuring the dry soil bar and the reporting interval (Notes 9.1 and 9.2).

### 2 Scope

This Test Method describes the procedure for the determination of the linear shrinkage of that portion of a soil passing a 0.425 mm sieve. The linear shrinkage is the percentage decrease in the longitudinal dimension of a soil bar when dried from the liquid limit to the oven dry state.

### 3 Definitions

For this Test Method the following definition shall apply:

- 3.1 Weighted linear shrinkage (WLS) - is defined as the product of the linear shrinkage (LS) of a soil and the percentage of the soil finer than 0.425 mm (Note 9.3).

### 4 Apparatus

Where appropriate, the working tolerances of apparatus are contained in Table 1.

The following apparatus is required:

- 4.1 Drying ovens:
- a) Oven of suitable capacity, having a temperature of 45-50°C and conforming to AS 1289.0.
  - b) Oven of suitable capacity, having a temperature of 105-110°C and conforming to AS 1289.0.
- 4.2 Linear shrinkage mould, stainless steel or brass mould, length 150 mm, width at top 25 mm, width at bottom 20 mm, depth 15 mm (Figure 1).
- 4.3 Suitable measuring device, with a resolution of at least 0.1 mm, for example, digital callipers.
- 4.4 Spatula.
- 4.5 Scalpel or similar alternative.
- 4.6 Marker and paper.
- 4.7 Steel ruler approximately 300 mm in length.

### 5 Materials

The following material is required:

- 5.1 Mould oil, a light oil such as Caltex Mould Oil 20 (Note 9.4). Other mould oils such as Shellmould P5, Reochem Mould Oil 20 and Caltex Mould Oil 222, Ampol Mould Oil 20 and WD40 Multi-Use Product (Spray) have also been found to be suitable.



## 6 Procedure

The procedure shall be as follows:

### 6.1 Filling and finishing the mould

- 6.1.1 Where this test is performed concurrently with Test Methods Q104A or Q104D, obtain sufficient soil / water mixture used in the liquid limit test (Q104A or Q104D) at the penetration of  $15.5 \pm 1.0$  mm.
- 6.1.2 Where this test is performed independently of Test Methods Q104A or Q104D, obtain sufficient cured soil prepared in accordance with Test Method Q104A Steps 6.1 to 6.5. Continue preparation of the cured soil by mixing, performing a penetration test and adding water in accordance with Test Method Q104A Steps 6.6 to 6.21 until consecutive penetrations of  $15.5 \pm 1.0$  mm are achieved. Obtain a subsample of the soil / water mixture from the cured soil.
- 6.1.3 Lightly oil the dry shrinkage mould.
- 6.1.4 Fill the mould with a subsample of the soil / water mixture.
- 6.1.5 Press the soil firmly into the mould, taking care to fill the corners and to eliminate air bubbles. Undertake this filling with the spatula held at right angles to the length of the mould, firstly, by firming the soil along one side of the mould, then the other. Finally, fill any indentations in the top so the soil is just proud of the edges of the mould.
- 6.1.6 Cut off the surplus soil with the steel ruler by drawing the steel ruler from the longitudinal centre of the mould towards each side in turn. Then use a maximum of two full sideways sweeps to smooth the surface if required. Wipe the ruler clean before each pass.
- 6.1.7 Place the filled mould in a 45-50°C oven for a minimum of two hours prior to drying to a constant mass in a 105-110°C oven.

### 6.2 Measurement

#### 6.2.1 Unbroken Soil Bar

- a) Remove the soil bar from the mould and carefully remove any lip at each end of the soil bar.
- b) Determine the internal length of the mould from the approximate geometric centre of one end of the mould to a similar point on the other end ( $L_1$ ).
- c) Place the bar on a strip of paper and shape the paper to conform to the longitudinal profile of the bottom of the bar. Mark the length on the paper using the scalpel with the mid points at each end clearly indicated.
- d) Determine the distance between the two mid points as the bottom length of the soil bar ( $L_2$ ).
- e) Repeat Step c) for the top of the bar.
- f) Determine the distance between the two mid points as the top length of the soil bar ( $L_3$ ).

#### 6.2.2 Broken Soil Bar

- a) Remove the soil bar from the mould and carefully remove any lip at each end of the soil bar.
- b) Determine the internal length of the mould from the approximate geometric centre of one end of the mould to a similar point on the other end ( $L_1$ ).

- c) Place the bar on a strip of paper and shape the paper to conform to the longitudinal profile of the bottom of the bar. Mark the length on the paper using the scalpel with the mid points at each end clearly indicated.
- d) Place the second segment such that the end where the first break occurred is coincident with the marked end of the break in the first segment. Mark the end of the second segment on the paper using the scalpel with the mid-point clearly indicated.
- e) Place and mark all subsequent segments in sequence as described in Step d) until all segments have been marked on the paper.
- f) Determine the distance between the first and last mid points as the bottom length of the soil bar ( $L_2$ ).
- g) Repeat Steps c) to e) for the top of the soil bar.
- h) Determine the distance between the first and last mid points as the top length of the soil bar ( $L_3$ ).
- i) Record the number of breaks in the soil bar at the completion of measurement.

## 7 Calculation

Calculations shall be as follows:

- 7.1 Calculate the linear shrinkage of the soil as follows:

$$LS = \frac{L_1 - 0.5(L_2 + L_3)}{L_1}$$

- where
- $LS$  = linear shrinkage of the soil (%)
  - $L_1$  = internal length of the mould (mm)
  - $L_2$  = bottom length of the soil bar (mm)
  - $L_3$  = top length of the soil bar (mm)

- 7.2 If required, calculate the WLS as follows:

$$WLS = LS \cdot P_{0.425}$$

- where
- $WLS$  = weighted linear shrinkage of the soil (%)
  - $LS$  = linear shrinkage of the soil (%)
  - $P_{0.425}$  = percentage passing the 0.425 mm sieve, obtained from Test Method Q103A

## 8 Reporting

The following shall be reported:

- 8.1 Linear shrinkage to the nearest 0.2%.
- 8.2 Weighted linear shrinkage to the nearest 1% (if required).
- 8.3 The number of this Test Method, that is Q106.

## 9 Notes on method

- 9.1 The use of a trapezoidal cross section mould and the drying process were developed through internal departmental investigations as reported in Vanderstaay AGB (1986) *An analysis of the linear shrinkage test MRD Test Method Q106 – 1986*, CR383, Central Division, Main Roads Department.
- 9.2 The use of a rule for the trimming of the mould was developed through internal departmental investigations as reported in Moule B (2008) *Analysis of the proposed linear shrinkage trimming method* [unpublished final year thesis], Materials Services Branch, Department of Transport and Main Roads.
- 9.3 The weighted linear shrinkage may also be defined as the shrinkage product. For example, the Australian Roads Research Board (May 2020) *Road Materials Best Practice Guide 1 – Appendix A*, uses this terminology.
- 9.4 Before handling oil, the operator should consult the relevant SDS.

**Table 1 – Working tolerances for apparatus**

Apparatus	Value	Tolerance
<b>Mould</b>		
Length (mm)	150	± 5
Inside width – top (mm)	25	± 0.5
Inside width – bottom (mm)	20	± 0.5
Inside depth (mm)	15	± 0.5

**Figure 1 – Linear shrinkage mould**

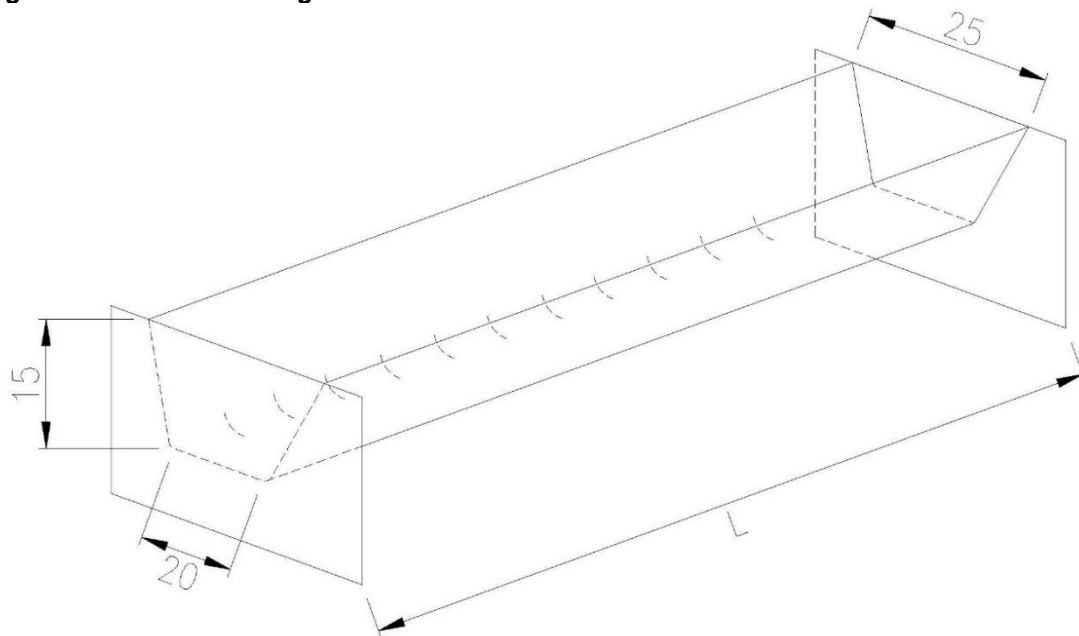

Not to scale

## Test Method Q113A: California Bearing Ratio of soil – standard

### 1 Source

This Test Method applies the principles of AS 1289.6.1.1: *Determination of the California Bearing Ratio of a soil for a remoulded specimen*. It differs from this standard in that it uses multiple specimens and limits the amount of correction which can be applied to the force – penetration curve to 0.5 mm. There are also minor changes to apparatus requirements.

### 2 Scope

This Test Method describes the procedure for determining the CBR. It is applicable to soil, gravel or crushed rock materials. CBR is defined as the ratio of the force required to cause a circular plunger of 1932 mm<sup>2</sup> area to penetrate the material for a specified distance expressed as a percentage of a standard force. The standard forces used in this Test Method are 13,200 and 19,800 newtons for penetrations of 2.5 and 5.0 mm respectively.

Test specimens are prepared from passing 19.0 mm material, cured at a range of moisture contents and compacted using a standard compactive effort of 596 kJ/m<sup>3</sup>. They are then tested either in a soaked or unsoaked condition. The Test Method allows for the determination of CBR, MDD and OMC as well as the optional determination of swell and post penetration moisture content. Neither CBR, MDD nor CBR OMC may be used for compaction control. The CBR of the material is determined at CBR OMC.

### 3 Apparatus

Where appropriate, the working tolerances of apparatus are contained in Tables 1 and 2. Examples of mould, spacer disc and handle, stem and perforated plate, tripod for swell gauge are contained in AS 1289.6.1.1, Figures 1, 2, 3 and 5.

The following apparatus is required:

#### 3.1 CBR machine, fitted with the following:

- a) a moveable lower platen that travels at a uniform vertical upward rate of 1 mm/min when measured loaded
- b) force measuring device, at least Class C as defined in AS 2193 for the range of forces used in this test and capable of indicating seating loads of 50 N and 250 N (Notes 8.1 and 8.2)
- c) penetration piston, having a diameter of 49.6 mm and about 190 mm long, having provision for affixing a suitable penetration gauge (Note 8.3), and
- d) penetration gauge, such as a dial gauge, conforming to the requirements of ISO 463 or JIS B 7503, with a resolution of 0.01 mm and a travel of 25 mm, or a displacement transducer of at least equal performance.

#### 3.2 Mould assembly, comprising a cylindrical metal mould having an internal diameter of 152 mm and a height of 178 mm, two detachable baseplates and a removable collar having a height of about 60 mm. One baseplate (perforated baseplate) should have 28 x 3 mm diameter holes uniformly distributed over the area of the plate.

#### 3.3 Spacer disc, having a diameter of 150 mm and a height of 61 mm.

#### 3.4 Stem and perforated plate, having a diameter of 150 mm, mass of 1000 g and with 42 x 3 mm diameter holes uniformly distributed over the plate.

- 3.5 Soaking weight, having a mass of 4500 g and a diameter of approximately 150 mm, with a centre hole of approximately 55 mm diameter. The surface of the weight in contact with the perforated plate is to be centrally recessed to a minimum depth of 2 mm for a diameter of approximately 120 mm.
- 3.6 Surcharge weights, two metal weights each having a mass of 2250 g and a diameter of 150 mm, with a centre hole of approximately 55 mm diameter.
- 3.7 Swell gauge, consisting of a tripod and a suitable gauge, for example, a dial gauge, conforming to the requirements of ISO 463 or JIS B 7503, with a resolution of 0.01 mm and a travel of 25 mm.
- 3.8 Setting piece, if swell is to be measured and the swell gauge is removed from the mould during soaking, to set the reading on the gauge attached to the tripod prior to each reading of the swell gauge.
- 3.9 Balance, of suitable capacity, having a resolution of at least 1 g and with a limit of performance within the range of  $\pm 5$  g.
- 3.10 Rammer, a metal rammer having a 50 mm diameter face, a drop mass of 2700 g and a drop height of 300 mm. Alternatively use a mechanical compactor, provided it meets the essential requirements of drop height, mass and energy input. A mechanical compactor may be used provided the essential dimensions are adhered to and the rammer has a free vertical fall of the correct height with blows being uniformly distributed and in keeping with any prescribed cycle of blows. The design of the compactor allows attachment of the mould to a level and rigid support base. The difference between MDD determinations using manual or mechanical compaction is less than 2%.
- 3.11 Sieves, 19.0 mm and 9.50 mm conforming to ISO 3310.
- 3.12 Water bath, of sufficient depth to immerse the moulded specimen in water.
- 3.13 Level and rigid foundation upon which to compact the specimen, for example, a 100 mm thick sound concrete floor or a concrete block of at least 100 kg mass.
- 3.14 Straightedge, made of steel and having the approximate dimensions of length 250 mm, width 25 mm and thickness 3 mm, preferably with a bevelled edge.
- 3.15 Sealable containers, suitable for curing soil samples.
- 3.16 Sample extruder, such as a jack, lever frame or other device suitable for extracting compacted soil specimens from the mould.
- 3.17 Material height gauge. A flat steel bar, about 250 mm long, 25 mm wide and 1-3 mm thick is satisfactory (Note 8.4).
- 3.18 Mixing apparatus, such as a tray, trowel or scoop and water sprayer.

#### **4 Materials**

The following materials are required:

- 4.1 Filter paper, a coarse filter paper such as Whatman No. 1.
- 4.2 Mould oil, a light mould oil such as Caltex Mould Oil 20 (Note 8.5).

## 5 Procedure

The procedure shall be as follows:

### 5.1 Sample preparation

- 5.1.1 Prepare the bulk sample in accordance with Section 4 of Test Method Q101 to produce a representative subsample of appropriate size.
- 5.1.2 Further prepare the material by screening the subsample on a 19.0 mm sieve in accordance with Q101, Steps 5.2.1 to 5.2.2. Ensure that any aggregations are broken up to pass a 9.50 mm sieve. Discard any material retained on the 19.0 mm sieve and thoroughly remix the material passing the 19.0 mm sieve.
- 5.1.3 Prepare four or more representative test portions of the sieved material in accordance with Test Method Q101, Steps 5.2.3 to 5.2.5 of appropriate mass.
- 5.1.4 Thoroughly mix each test portion in turn with sufficient water so that the range of their moisture contents should straddle OMC (Note 8.6). The moisture increments between portions shall be essentially equal (Note 8.7).
- 5.1.5 After mixing, place each test portion in a sealed container and allowed to cure for an appropriate time for the material (refer to Table 3) (Note 8.8). Record the times of commencement and completion of the curing.
- 5.1.6 Record the method for determining the plasticity level (refer to Table 3), that is, test method, source records or visual / tactile assessment.

### 5.2 Mould preparation

- 5.2.1 Lightly oil the inside of the mould and then assemble the mould and perforated baseplate.
- 5.2.2 Determine the mass of the mould and perforated baseplate ( $m_1$ ). When a soaked CBR test is to be performed, add two filter papers to the mould and perforated baseplate.
- 5.2.3 Attach the second baseplate to the mould, invert the mould and remove the perforated baseplate and both filter papers, if added. Insert the spacer disc in the mould and attach the collar to the mould.

### 5.3 Compaction

- 5.3.1 Spread the cured test portion on the mixing tray and thoroughly remix. Take a representative moisture sample and determine the compacted moisture content ( $w$ ) in accordance with Test Method AS 1289.2.1.1.
- 5.3.2 Place sufficient of the mixed test portion in the mould to achieve a mean compacted height within the range of 39 mm to 44 mm.
- 5.3.3 Compact the material in the mould using 53 uniformly distributed blows of the rammer falling freely through its full height.
- 5.3.4 Measure the height of the compacted specimen using the layer depth gauge at a minimum of four locations such that the mean of the measurements is representative of the mean height of the specimen. Discard the specimen if its mean height falls outside the range of 39 mm to 44 mm.
- 5.3.5 Repeat Steps 5.3.2 to 5.3.4, except that the mean compacted height of the specimen shall be within the range of 78 mm to 83 mm.

- 5.3.6 Repeat Steps 5.3.2 to 5.3.4, except that the mean compacted height of the specimen shall be within the range of 117 mm to 122 mm.
- 5.3.7 Remove the collar and level the compacted material to the top of the mould by means of the straightedge. Fill any holes developed in the surface due to removal of coarse material using some of the excess material. When a soaked CBR test is to be performed, place a filter paper on the surface of the compacted material.
- 5.3.8 Reattach the perforated baseplate to the mould and invert the mould. Remove the second baseplate and spacer disc. When a soaked CBR test is to be performed, place a filter paper on the surface of the compacted material.
- 5.3.9 Determine the mass of the mould, perforated baseplate and compacted material ( $m_2$ ).
- 5.3.10 When testing the compacted material in the soaked condition, soak the compacted material as detailed in Subsection 5.4.
- 5.3.11 When testing the compacted material in the unsoaked condition, penetrate the compacted material in accordance with Subsection 5.5.
- 5.3.12 Prepare additional moulds in accordance with Subsection 5.2 and Subsection 5.3 for the other test portions so that at least four specimens are penetrated. These specimens shall include at least two specimens dry of OMC and shall provide a range of moisture content that straddles OMC and adequately defines the dry density/moisture content relationship under these compaction conditions. If necessary, cure, compact and penetrate additional test portions in accordance with Subsections 5.1, 5.3 and 5.5.

#### **5.4 Soaking**

- 5.4.1 Centrally locate the stem and perforated plate together with a soaking weight on the filter paper.
- 5.4.2 If measurement of swell is required, undertake the measurement as follows:
  - a) If the swell gauge is to be removed from the mould during soaking:
    - i. set the reading on the gauge against the setting piece
    - ii. obtain an initial reading by placing the tripod of the swell gauge on the top of the mould so that the contact point of the dial gauge is in contact with the highest point of the stem
    - iii. mark reference points to permit relocation of swell gauge to the same spots after soaking, and
    - iv. record the dial gauge reading ( $r_2$ ) before removing the swell gauge.
  - b) If the swell gauge is not removed from the mould during soaking:
    - i. obtain an initial reading by placing the tripod of the swell gauge on the top of the mould so that the contact point of the dial gauge is in contact with the highest point of the stem, and
    - ii. record the dial gauge reading ( $r_1$ ).
- 5.4.3 Place the mould in the water bath, allowing free access of water to the top and bottom of the specimen. Soak the specimen for  $96 \pm 4$  hours with the water level being maintained above the mould during this period.

- 5.4.4 If measurement of swell is required, after soaking is completed but prior to removing the mould from the water bath, undertake the measurement as follows:
- a) If the swell gauge was removed from the mould during soaking:
    - i. set the reading on the gauge against the setting piece to the same value in Step 5.4.2 a) i.
    - ii. place the tripod of the swell gauge at the reference points marked in Step 5.4.2 a) iii., and
    - iii. record the dial gauge reading ( $r_2$ ) before removing the swell gauge.
  - b) If the swell gauge was not removed from the mould during soaking:
    - i. record the dial gauge reading ( $r_2$ ) before removing the swell gauge.
- 5.4.5 Remove the mould from the water bath and tilt the mould to pour off any excess water. Return it to the upright position and allow draining for 15 minutes. Do not disturb the surface of the specimen during the removal of water.
- 5.4.6 Remove the soaking weight and the stem and perforated plate from the mould.
- 5.4.7 Penetrate the specimen in accordance with Subsection 5.5.

## 5.5 Penetration

- 5.5.1 Centrally locate the two surcharge weights on the compacted material in the mould.
- 5.5.2 Position the mould on the platen of the CBR machine so that the mould is located centrally under the penetration piston and the piston almost touches the surface of the material.
- 5.5.3 Zero the force measuring device indicator and seat the penetration piston, with the smallest possible load, not exceeding 50 N for an expected CBR equal to or less than 30% and 250 N for expected CBR greater than 30% (Note 8.9).
- 5.5.4 Zero the force measuring device indicator and penetration gauge (Note 8.10).
- 5.5.5 Commence penetration of the specimen and record the force measuring device indicator readings for every 0.5 mm penetration to a minimum penetration of 7.5 mm.
- 5.5.6 Remove the mould from the CBR machine. Remove the surcharge weights. Extrude the compacted soil from the mould and obtain any requested final moisture content ( $w_2$ ) as follows:
- a) For compacted material penetrated in the soaked condition:
    - i. Remove the filter papers and obtain a moisture sample to a depth of 30 mm from the end of the specimen that contains the penetration depression.
    - ii. Obtain a second moisture sample from a uniform section through the entire depth of the remainder of the specimen.
    - iii. Determine the moisture content ( $w_2$ ) of each moisture sample in accordance with Test Method AS 1289.2.1.1.
  - b) For compacted material penetrated in the unsoaked condition:
    - i. Obtain a moisture sample from a uniform section through the entire depth of the specimen.
    - ii. Determine the moisture content ( $w_2$ ) of the moisture sample in accordance with Test Method AS 1289.2.1.1.



## 6 Calculations

Calculations shall be as follows:

### 6.1 Compacted dry density

6.1.1 Calculate the compacted dry density as follows:

$$\rho_d = \frac{100(m_2 - m_1)}{V(100 + w_a)}$$

where	$\rho_d$	=	compacted dry density (t/m <sup>3</sup> )
	$m_2$	=	mass of mould, baseplate and compacted material (g)
	$m_1$	=	mass of mould and baseplate (g)
	$V$	=	effective volume of mould (cm <sup>3</sup> )
	$w_a$	=	compacted moisture content (%)

### 6.2 Zero air voids line

6.2.1 Determine at least two moisture content points for the chosen air voids line, from the soil particle density (Note 8.11) by using dry density values corresponding to the lowest and highest values determined in Step 6.1 as follows (Note 8.12):

$$w = \frac{100 - V_a}{\rho_d} - \frac{100}{\rho_s}$$

where	$w$	=	moisture content, expressed as a percentage of the mass of dry material
	$V_a$	=	volume of chosen air voids, expressed as a percentage of the volume of undried material
	$\rho_d$	=	dry density of material (t/m <sup>3</sup> )
	$\rho_s$	=	soil particle density (t/m <sup>3</sup> )

### 6.3 Swell

6.3.1 If the measurement of swell is required, calculate it for each specimen as follows:

$$s = \left( \frac{r_2 - r_1}{117} \right) 100$$

where	$s$	=	swell (%)
	$r_2$	=	final dial gauge reading (mm)
	$r_1$	=	initial dial gauge reading (mm)

### 6.4 Bearing ratio

Determine the bearing ratio at 2.5 mm and 5.0 mm penetration for each specimen as follows:

6.4.1 Convert the force indicator readings to applied forces in newtons using the appropriate calibration for the force measuring device (Note 8.13).

6.4.2 Plot the applied forces against the corresponding penetration values and draw a smooth curve through the points.

- 6.4.3 When the force-penetration curve commences with a concave upward portion that transitions to a linear portion (refer to AS 1289.6.1.1 Figure 6, curve 3 and Note 8.14), then transitions to concave downward, adjust the penetration scale as follows:
- Draw a tangent through the steepest part of the curve to intersect the penetration axis.
  - The intercept with the penetration (x) axis is the new origin provided its value does not exceed 0.5 mm.
  - Where the intercept exceeds 0.5 mm, the new origin is 0.5 mm.
  - Adjust the 2.5 mm and 5.0 mm values in relation to the re-designated origin.
- 6.4.4 When the force-penetration curve commences with a linear portion and may transition to concave downward (refer to AS 1289.6.1.1 Figure 6, curve 2), no adjustment is made to the penetration scale.
- 6.4.5 When the force-penetration curve commences with a concave upward portion that does not transition to a linear portion (refer to AS 1289.6.1.1 Figure 6, curve 1), no adjustment is made to the penetration scale.
- 6.4.6 Determine the values of applied force ( $f_{2.5}$  and  $f_{5.0}$ ) corresponding to the adjusted 2.5 mm and 5.0 mm penetrations.
- 6.4.7 Calculate the bearing ratio at 2.5 mm and 5.0 mm penetrations and record these ratios as  $BR_{2.5}$  and  $BR_{5.0}$  as follows:

$$BR_{2.5} = \frac{f_{2.5}100}{13200}$$

$$BR_{5.0} = \frac{f_{5.0}100}{19800}$$

- where
- $BR_{2.5}$  = Bearing ratio corresponding to 2.5 mm penetration (%)
  - $BR_{5.0}$  = Bearing ratio corresponding to 5.0 mm penetration (%)
  - $f_{2.5}$  = applied force corresponding to 2.5 mm penetration (N)
  - $f_{5.0}$  = applied force corresponding to 5.0 mm penetration (N)

## 6.5 California Bearing Ratio

- 6.5.1 Plot the compacted dry densities for the compacted specimens against their corresponding compacted moisture contents.
- 6.5.2 Plot the zero air voids data (corresponding to compacted dry densities and compacted moisture contents) on the same graph used in Step 6.5.1 and draw a straight line through the points.
- 6.5.3 Draw a smooth curve of best fit through the data points plotted in Step 6.5.1 with the wet leg of the curve tending parallel to the zero air voids line.
- 6.5.4 Plot the bearing ratios of the compacted specimens on a semi-logarithmic scale against their corresponding compacted moisture contents on a linear scale.
- 6.5.5 Draw one smooth curve through bearing ratios corresponding to 2.5 mm penetration and draw another smooth curve through bearing ratios corresponding to 5.0 mm penetration.
- 6.5.6 Determine the bearing ratios corresponding to the peak of the compacted dry density versus compacted moisture content curve and record as BR 2.5 mm and BR 5.0 mm respectively.

- 6.5.7 Determine the peak compacted dry density and record as the CBR MDD. Determine the compacted moisture content corresponding to the peak dry density and record as the CBR OMC.

## 7 Reporting

The following shall be reported:

### 7.1 Compaction results:

- a) A tabulation of compacted moisture content (refer to Test Method AS 1289.2.1.1) and compacted dry density to the nearest  $0.01 \text{ t/m}^3$ , together with the bearing ratio at 2.5 mm penetration and the bearing ratio at 5.0 mm penetration for each specimen.
- b) A graph of compacted dry density versus compacted moisture content, together with a plot of the zero air voids line or assumed zero air voids line.
- c) The dry density corresponding to the maximum point on the compacted dry density / moisture content curve as the CBR MDD to the nearest  $0.01 \text{ t/m}^3$ .
- d) The percentage moisture content corresponding to the CBR MDD on the compacted dry density / moisture content curve as the CBR OMC to the nearest 0.5%.
- e) Method of curve fitting, for example, hand drawn or cubic-spline,  $n^{\text{th}}$  order polynomial and so on.

### 7.2 CBR results:

- a) A semi logarithmic graph of bearing ratio versus compacted moisture content.
- b) BR 2.5 mm and BR 5.0 mm (refer to Table 4).
- c) The material CBR value which is the largest numerical value of either BR 2.5 mm or BR 5.0 mm (refer to Table 4).
- d) Method of curve fitting, for example, hand drawn, cubic-spline,  $n^{\text{th}}$  order polynomial and so on.

### 7.3 Test / curing conditions:

- a) Test condition, that is, soaked or unsoaked.
- b) Duration of curing to the nearest hour.
- c) Method for determining the plasticity level (refer to Table 3), that is, test method, source records or visual / tactile assessment.
- d) The compactive effort (standard) used.

### 7.4 The number of this Test Method, that is Q113A.

The following may be reported:

### 7.5 Additional information:

- a) Swell of each soaked specimen to the nearest 0.1% for values less than 10, otherwise to the nearest 1%.
- b) Final moisture content(s) of each specimen after penetration (refer to Test Method AS 1289.2.1.1).
- c) The force-penetration graph of the specimen having the compacted moisture content closest to CBR OMC.

## 8 Notes on method

- 8.1 Calibrate the force measuring device over its complete operating range. This will require further points near to zero in addition to those required by AS 2193.
- 8.2 For each test, select a force measuring device which is Class C for that part of its operating range which corresponds to the forces required to produce plunger penetrations of 2.5 mm and greater.
- 8.3 Where the applied force is measured using a device such as a load transducer, the penetration gauge may be affixed to the frame of the machine.
- 8.4 A material height gauge, which allows monitoring of the height of compacted material relative to the top of a CBR mould, can be made from a steel bar as follows:
- 8.4.1 CBR Mould – Standard (Std) compaction.  
Commencing at one end of the bar, measure, and mark distances of:
- 39 mm and 34 mm for the acceptable range of the second layer, and
  - 78 mm and 73 mm for the acceptable range of the first layer.
- 8.4.2 Mark the face with the compactive effort (Std).
- 8.5 Before handling oil, the operator should consult the relevant SDS.
- 8.6 To straddle OMC, it may be necessary to remove water from one or more test portions by air drying or oven drying at 45 to 50°C.
- 8.7 Suitable intervals for moisture increments range from 1% for a gravel to 2 to 3% for a clay.
- 8.8 Where the liquid limit has not been determined in accordance with Test Methods Q104A or Q104D, use either a liquid limit from source records or an estimate based on a visual / tactile assessment for estimating the curing time for the CBR test portions.
- 8.9 In some very weak materials where the seating load causes significant penetration, this step can be omitted provided this variation to the method is reported.
- 8.10 Where zeroing the force measuring device indicator will invalidate the calibration of the device, do not zero the indicator and record the indicator reading as the seating deflection.
- 8.11 Obtain the value of the material's soil particle density for calculating the air voids lines using the method described in AS 1289.3.5.1 or assume based on previous tests. A rough check on the material soil particle density is to select the dry density and moisture content of the wettest data point, nominate a percent air voids (2% often gives a satisfactory result) and calculate an soil particle density as follows:

$$\rho_s = \frac{100\rho_d}{(100 - V_a) - \rho_d w}$$

where	$\rho_s$	=	soil particle density (t/m <sup>3</sup> )
	$\rho_d$	=	dry density of material (t/m <sup>3</sup> )
	$V_a$	=	nominated air voids (%)
	$w$	=	moisture content expressed as a percentage of the mass of dry material

The material's soil particle density so derived is the assumed value.

- 8.12 Appropriate values of calculated dry density are the smallest and largest scale values used on the graph of calculated dry density versus initial moisture content.
- 8.13 Where the force measuring device indicator was not zeroed after the application of the seating load. Convert the seating deflection to applied force in newtons and subtract from each of the calculated values of applied force.
- 8.14 This characteristic may be due to surface irregularities, material behaviour or other causes.

**Table 1 – Dimensions and tolerances for CBR equipment**

Apparatus	Dimension	Tolerance
<b>CBR machine</b>		
Platen travel rate – loaded (mm/min)	1	± 0.2
<b>Penetration piston</b>		
Diameter (mm)	49.6	± 0.1
<b>Mould</b>		
Internal diameter (mm)	152	± 1
Height (mm)	178	± 1
<b>Perforated baseplate</b>		
Hole number	28	+5, -0
Hole diameter (mm)	3	± 0.2
<b>Spacer disc</b>		
Diameter (mm)	150	± 0.5
Height (mm)	61	± 0.25
<b>Stem and perforated plate</b>		
Diameter (mm)	150	± 0.5
Mass (g)	1000	± 25
Hole number	42	± 0
Hole diameter (mm)	3	± 0.2
<b>Soaking weight</b>		
Mass (g)	4500	± 50
<b>Surcharge weight</b>		
Mass (g)	2250	± 25
Diameter (mm)	150	± 0.5
<b>Levelling plate</b>		
Diameter (mm)	151	0, -1
Height (mm)	20	minimum

**Table 2 – Dimensions and tolerances for rammers**

Apparatus	Dimension	Tolerance
<b>Rammer – standard</b>		
Face diameter (mm)	50	± 0.4
Drop (mm)	300	± 2.0
Mass (g)	2700	± 10

**Table 3 – Minimum curing time**

Plasticity	Minimum curing time (hours)
Sands and unbound material*	2
Low (LL ≤ 35%)	48
Medium (35 < LL ≤ 50%)	96 (4 days)
High (LL > 50%)	168 (7 days)

\* These can include naturally occurring sands and gravels, crushed rocks and manufactured materials with a fines (< 0.075 mm) content less than 12%.

**Table 4 – Reporting intervals for CBR**

CBR (%)	Reporting interval
≤ 5	nearest 0.5
>5 to ≤20	nearest 1
>20 to ≤50	nearest 5
> 50	nearest 10

## Test Method Q113B: California Bearing Ratio of soil – modified

### 1 Source

This Test Method applies the principles of AS 1289.6.1.1: *Determination of the California Bearing Ratio of a soil for a remoulded specimen*. It differs from this standard in that it uses multiple specimens and limits the amount of correction which can be applied to the force – penetration curve to 0.5 mm. There are also minor changes to apparatus requirements.

### 2 Scope

This Test Method describes the procedure for determining the CBR. It is applicable to soil, gravel or crushed rock materials. California Bearing Ratio is defined as the ratio of the force required to cause a circular plunger of 1932 mm<sup>2</sup> area to penetrate the material for a specified distance expressed as a percentage of a standard force. The standard forces used in this method are 13,200 and 19,800 newtons for penetrations of 2.5 and 5.0 mm respectively.

Test specimens are prepared from passing 19.0 mm material, cured at a range of moisture contents and compacted using a modified compactive effort of 2703 kJ/m<sup>3</sup>. They are then tested either in a soaked or unsoaked condition. The Test Method allows for the determination of CBR MDD and CBR OMC, as well as the optional determination of swell and post penetration moisture content. Neither CBR MDD nor CBR OMC may be used for compaction control. The CBR of the material is determined at CBR OMC.

### 3 Apparatus

Where appropriate, the working tolerances of apparatus are contained in Tables 1 and 2. Examples of mould, spacer disc and handle, stem and perforated plate, tripod for swell gauge are contained in AS 1289.6.1.1, Figures 1, 2, 3 and 5.

The following apparatus is required:

- 3.1 CBR machine, fitted with the following:
  - a) a moveable lower platen that travels at a uniform vertical upward rate of 1 mm / min when measured loaded
  - b) force measuring device, at least Class C as defined in AS 2193 for the range of forces used in this test and capable of indicating seating loads of 50 N and 250 N (Notes 8.1 and 8.2)
  - c) penetration piston, having a diameter of 49.6 mm and about 190 mm long, having provision for affixing a suitable penetration gauge (Note 8.3), and
  - d) penetration gauge, such as a dial gauge, conforming to the requirements of ISO 463 or JIS B 7503, with a resolution of 0.01 mm and a travel of 25 mm, or a displacement transducer of at least equal performance.
- 3.2 Mould assembly, comprising a cylindrical metal mould having an internal diameter of 152 mm and a height of 178 mm, two detachable baseplates and a removable collar having a height of about 60 mm which can be firmly attached to the mould. One baseplate (perforated baseplate) should have 28 x 3 mm diameter holes uniformly distributed over the area of the plate.
- 3.3 Spacer disc, having a diameter of 150 mm and a height of 61 mm.

- 3.4 Stem and perforated plate, having a diameter of 150 mm, mass of 1000 g and with 42 x 3 mm diameter holes uniformly distributed over the plate.
- 3.5 Soaking weight, having a mass of 4500 g and a diameter of approximately 150 mm, with a centre hole of approximately 55 mm diameter. The surface of the weight in contact with the perforated plate is to be centrally recessed to a minimum depth of 2 mm for a diameter of approximately 120 mm.
- 3.6 Surcharge weights, two metal weights each having a mass of 2250 g and a diameter of 150 mm, with a centre hole of approximately 55 mm diameter.
- 3.7 Swell gauge, consisting of a tripod and a suitable gauge, for example, a dial gauge, conforming to the requirements of ISO 463 or JIS B 7503m with a resolution of 0.01 mm and a travel of 25 mm.
- 3.8 Setting piece, if swell is to be measured and the swell gauge is removed from the mould during soaking, to set the reading on the gauge attached to the tripod prior to each reading of the swell gauge.
- 3.9 Balance of suitable capacity, having a resolution of at least 1 g and with a limit of performance within the range of  $\pm 5$  g.
- 3.10 Rammer, a metal rammer having a 50 mm diameter face, a drop mass of 4900 g and a drop height of 450 mm. Alternatively use a mechanical compactor, provided it meets the essential requirements of drop height, mass and energy input. A mechanical compactor may be used provided the essential dimensions are adhered to and the rammer has a free vertical fall of the correct height with blows being uniformly distributed and in keeping with any prescribed cycle of blows. The design of the compactor allows attachment of the mould to a level and rigid support base. The difference between MDD determinations using manual or mechanical compaction is less than 2%.
- 3.11 Sieves, 19.0 mm and 9.50 mm conforming to ISO 3310.
- 3.12 Water bath, of sufficient depth to immerse the moulded specimen in water.
- 3.13 Level and rigid foundation upon which to compact the specimen, for example, a 100 mm thick sound concrete floor or a concrete block of at least 100 kg mass.
- 3.14 Straightedge, made of steel and having the approximate dimensions of length 250 mm, width 25 mm and thickness 3 mm, preferably with a bevelled edge.
- 3.15 Sealable containers, suitable for curing soil samples.
- 3.16 Sample extruder, such as a jack, lever frame or other device suitable for extracting compacted soil specimens from the mould.
- 3.17 Material height gauge. A flat steel bar, about 250 mm long, 25 mm wide and 1-3 mm thick is satisfactory (Note 8.4).
- 3.18 Mixing apparatus, such as a tray, trowel or scoop and water sprayer.

#### **4 Materials**

The following materials are required:

- 4.1 Filter paper, a coarse filter paper such as Whatman No 1.
- 4.2 Mould oil, a light mould oil such as Caltex Mould Oil 20 (Note 8.5).



## 5 Procedure

The procedure shall be as follows:

### 5.1 Sample preparation

- 5.1.1 Prepare the bulk sample in accordance with Section 4 of Test Method Q101 to produce a representative subsample of appropriate size.
- 5.1.2 Further prepare the material by screening the subsample on a 19.0 mm sieve in accordance with Q101, Steps 5.2.1 to 5.2.2. Ensure that any aggregations are broken up to pass a 9.50 mm sieve. Discard any material retained on the 19.0 mm sieve and thoroughly remix the material passing the 19.0 mm sieve.
- 5.1.3 Prepare four or more representative test portions of the sieved material in accordance with Test Method Q101, Steps 5.2.3 to 5.2.5 of appropriate mass.
- 5.1.4 Thoroughly mix each test portion in turn with sufficient water so that the range of their moisture contents is judged to straddle OMC (Note 8.6). The moisture increments between portions shall be essentially equal (Note 8.7).
- 5.1.5 After mixing, place each test portion in a sealed container and allow to cure for an appropriate time for the material (refer to Table 3) (Note 8.8). Record the times of commencement and completion of the curing.
- 5.1.6 Record the method for determining the plasticity level (refer to Table 3), that is, test method or visual/tactile assessment.

### 5.2 Mould preparation

- 5.2.1 Lightly oil the inside of the mould and then assemble the mould and perforated baseplate.
- 5.2.2 Determine the mass of the mould and perforated baseplate ( $m_1$ ). When a soaked CBR test is to be performed, add two filter papers to the mould and perforated baseplate.
- 5.2.3 Attach the second baseplate to the mould, invert the mould and remove the perforated baseplate and both filter papers, if added. Insert the spacer disc in the mould and attach the collar to the mould.

### 5.3 Compaction

- 5.3.1 Spread the cured test portion on the mixing tray and thoroughly remix. Take a representative moisture sample and determine the compacted moisture content ( $w_a$ ) in accordance with Test Method AS 1289.2.1.1.
- 5.3.2 Place sufficient of the mixed test portion in the mould to achieve a mean compacted height within the range of 21 mm to 25 mm.
- 5.3.3 Compact the material in the mould using 53 uniformly distributed blows of the rammer falling freely through its full height.
- 5.3.4 Measure the height of the compacted specimen using the layer depth gauge at a minimum of four locations such that the mean of the measurements is representative of the mean height of the specimen. Discard the specimen if its mean height falls outside the range of 21 mm to 25 mm.
- 5.3.5 Repeat Steps 5.3.2 to 5.3.4, except that the mean compacted height of the specimen shall be within the range of 45 mm to 49 mm.

- 5.3.6 Repeat Steps 5.3.2 to 5.3.4, except that the mean compacted height of the specimen shall be within the range of 68 mm to 72 mm.
- 5.3.7 Repeat Steps 5.3.2 to 5.3.4, except that the mean compacted height of the specimen shall be within the range of 92 mm to 96 mm.
- 5.3.8 Repeat Steps 5.3.2 to 5.3.4, except that the mean compacted height of the specimen shall be within the range of 117 mm to 122 mm.
- 5.3.9 Remove the collar and level the compacted material to the top of the mould by means of the straightedge. Fill any holes developed in the surface due to the removal of coarse material using some of the excess material. When a soaked CBR test is to be performed, place a filter paper on the surface of the compacted material.
- 5.3.10 Reattach the perforated baseplate to the mould and invert the mould. Remove the second baseplate and spacer disc. When a soaked CBR test is to be performed, place a filter paper on the surface of the compacted material.
- 5.3.11 Determine the mass of the mould, perforated baseplate and compacted material ( $m_2$ ).
- 5.3.12 When testing the compacted material in the soaked condition, soak the compacted material in accordance with Subsection 5.4.
- 5.3.13 When testing the compacted material in the unsoaked condition, penetrate the compacted material in accordance with Subsection 5.5.
- 5.3.14 Prepare additional moulds in accordance with Subsection 5.2 and Subsection 5.3 for the other test portions so that at least four specimens are penetrated. These specimens shall include at least two specimens dry of OMC and shall provide a range of moisture content that straddles OMC and adequately defines the dry density/moisture content relationship under these compaction conditions. If necessary, cure, compact and penetrate additional test portions in accordance with Subsections 5.1, 5.3 and 5.5.

#### **5.4 Soaking**

- 5.4.1 Centrally locate the stem and perforated plate together with a soaking weight on the filter paper.
- 5.4.2 If measurement of swell is required, undertake the measurement as follows:
  - a) If the swell gauge is to be removed from the mould during soaking:
    - i. set the reading on the gauge against the setting piece
    - ii. obtain an initial reading by placing the tripod of the swell gauge on the top of the mould so that the contact point of the dial gauge is in contact with the highest point of the stem
    - iii. mark reference points to permit relocation of swell gauge to the same spots after soaking, and
    - iv. record the dial gauge reading ( $r_1$ ) before removing the swell gauge.
  - b) If the swell gauge is not removed from the mould during soaking:
    - i. obtain an initial reading by placing the tripod of the swell gauge on the top of the mould so that the contact point of the dial gauge is in contact with the highest point of the stem, and
    - ii. record the dial gauge reading ( $r_1$ ).

- 5.4.3 Place the mould in the water bath, allowing free access of water to the top and bottom of the specimen. Soak the specimen for  $96 \pm 4$  hours with the water level being maintained above the mould during this period.
- 5.4.4 If measurement of swell is required, after soaking is completed but prior to removing the mould from the water bath, undertake the measurement as follows:
- a) If the swell gauge was removed from the mould during soaking:
    - i. set the reading on the gauge against the setting piece to the same value in Step 5.4.2 a) i.
    - ii. place the tripod of the swell gauge at the reference points marked in Step 5.4.2 a) iii., and
    - iii. record the dial gauge reading ( $r_2$ ) before removing the swell gauge.
  - b) If the swell gauge was not removed from the mould during soaking:
    - i. record the dial gauge reading ( $r_2$ ) before removing the swell gauge.
- 5.4.5 Remove the mould from the water bath and tilt the mould to pour off any excess water. Return it to the upright position and allow draining for 15 minutes. Do not disturb the surface of the specimen during the removal of water.
- 5.4.6 Remove the soaking weight and the stem and perforated plate from the mould.
- 5.4.7 Penetrate the specimen in accordance with Subsection 5.5.

## 5.5 Penetration

- 5.5.1 Centrally locate the two surcharge weights on the compacted material in the mould.
- 5.5.2 Position the mould on the platen of the CBR machine so that the mould is located centrally under the penetration piston and the piston almost touches the surface of the material.
- 5.5.3 Zero the force measuring device indicator and seat the penetration piston, with the smallest possible load, not exceeding 50 N for an expected CBR equal to or less than 30% and 250 N for expected CBR greater than 30% (Note 8.9).
- 5.5.4 Zero the force measuring device indicator and penetration gauge (Note 8.10).
- 5.5.5 Commence penetration of the specimen and record the force measuring device indicator readings for every 0.5 mm penetration to a minimum penetration of 7.5 mm.
- 5.5.6 Remove the mould from the CBR machine. Remove the surcharge weights. Extrude the compacted soil from the mould and obtain any requested final moisture content ( $w_2$ ) as follows:
- a) For compacted material penetrated in the soaked condition:
    - i. Remove the filter papers and obtain a moisture sample to a depth of 30 mm from the end of the specimen that contains the penetration depression.
    - ii. Obtain a second moisture sample from a uniform section through the entire depth of the remainder of the specimen.
    - iii. Determine the moisture content ( $w_2$ ) of each moisture sample in accordance with Test Method AS 1289.2.1.1.

- b) For compacted material penetrated in the unsoaked condition:
- i. Obtain a moisture sample from a uniform section through the entire depth of the specimen.
  - ii. Determine the moisture content ( $w_2$ ) of the moisture sample in accordance with Test Method AS 1289.2.1.1.

## 6 Calculations

Calculations shall be as follows:

### 6.1 Compacted dry density

6.1.1 Calculate the compacted dry density as follows:

$$\rho_d = \frac{100(m_2 - m_1)}{V(100 + w_a)}$$

- where
- $\rho_d$  = compacted dry density (t/m<sup>3</sup>)
  - $m_2$  = mass of mould, baseplate and compacted material (g)
  - $m_1$  = mass of mould and baseplate (g)
  - $V$  = effective volume of mould (cm<sup>3</sup>)
  - $w_a$  = compacted moisture content (%)

### 6.2 Zero air voids line

6.2.1 Determine at least two moisture content points for the chosen air voids line, from the soil particle density (Note 8.11) by using dry density values corresponding to the lowest and highest values determined in Step 6.1 as follows (Note 8.12):

$$w = \frac{100 - V_a}{\rho_d} - \frac{100}{\rho_s}$$

- where
- $w$  = moisture content, expressed as a percentage of the mass of dry material
  - $V_a$  = volume of chosen air voids, expressed as a percentage of the volume of undried material
  - $\rho_d$  = dry density of material (t/m<sup>3</sup>)
  - $\rho_s$  = soil particle density (t/m<sup>3</sup>)

### 6.3 Swell

If the measurement of swell is required, calculate it for each specimen as follows:

$$s = \left( \frac{r_2 - r_1}{117} \right) 100$$

- where
- $s$  = swell (%)
  - $r_2$  = final dial gauge reading (mm)
  - $r_1$  = initial dial gauge reading (mm)

### 6.4 Bearing ratio

Determine the bearing ratio at 2.5 mm and 5.0 mm penetration for each specimen as follows:

6.4.1 Convert the force indicator readings to applied forces in newtons using the appropriate calibration for the force measuring device (Note 8.13).

- 6.4.2 Plot the applied forces against the corresponding penetration values and draw a smooth curve through the points.
- 6.4.3 When the force-penetration curve commences with a concave upward portion that transitions to a linear portion (refer to AS 1289.6.1.1 Figure 6, curve 3 and Note 8.14), then transitions to concave downward, adjust the penetration scale as follows:
- draw a tangent through the steepest part of the curve to intersect the penetration axis
  - the intercept with the penetration (x) axis is the new origin provided its value does not exceed 0.5 mm
  - where the intercept exceeds 0.5 mm, the new origin is 0.5 mm
  - adjust the 2.5 mm and 5.0 mm values in relation to the re-designated origin.
- 6.4.4 When the force-penetration curve commences with a linear portion and may transition to concave downward (refer to AS 1289.6.1.1 Figure 6, curve 2), no adjustment is made to the penetration scale.
- 6.4.5 When the force-penetration curve commences with a concave upward portion that does not transition to a linear portion (refer to AS 1289.6.1.1 Figure 6, curve 1), no adjustment is made to the penetration scale.
- 6.4.6 Determine the values of applied force ( $f_{2.5}$  and  $f_{5.0}$ ) corresponding to the adjusted 2.5 mm and 5.0 mm penetrations.
- 6.4.7 Calculate the bearing ratio at 2.5 mm and 5.0 mm penetrations and record these ratios as  $BR_{2.5}$  and  $BR_{5.0}$  as follows:

$$BR_{2.5} = \frac{f_{2.5}100}{13200}$$

$$BR_{5.0} = \frac{f_{5.0}100}{19800}$$

- where
- $BR_{2.5}$  = Bearing ratio corresponding to 2.5 mm penetration %
  - $BR_{5.0}$  = Bearing ratio corresponding to 5.0 mm penetration %
  - $f_{2.5}$  = applied force corresponding to 2.5 mm penetration (N)
  - $f_{5.0}$  = applied force corresponding to 5.0 mm penetration (N)

## 6.5 California Bearing Ratio

- 6.5.1 Plot the compacted dry densities for the compacted specimens against their corresponding compacted moisture contents.
- 6.5.2 Plot the zero air voids data (corresponding to compacted dry densities and compacted moisture contents) on the same graph used in Step 6.5.1 and draw a straight line through the points.
- 6.5.3 Draw a smooth curve of best fit through the data points plotted in Step 6.5.1 with the wet leg of the curve tending parallel to the zero air voids line.
- 6.5.4 Plot the bearing ratios of the compacted specimens on a semi-logarithmic scale against their corresponding compacted moisture contents on a linear scale.
- 6.5.5 Draw one smooth curve through bearing ratios corresponding to 2.5 mm penetration and draw another smooth curve through bearing ratios corresponding to 5.0 mm penetration.

6.5.6 Determine the bearing ratios corresponding to the peak of the compacted dry density versus compacted moisture content curve and record as BR 2.5 mm and BR 5.0 mm respectively.

6.5.7 Determine the peak compacted dry density and record as the CBR MDD. Determine the compacted moisture content corresponding to the peak dry density and record as the CBR OMC.

## 7 Reporting

The following shall be reported:

7.1 Compaction results:

- a) A tabulation of compacted moisture content (refer to Test Method AS 1289.2.1.1) and compacted dry density to the nearest  $0.01 \text{ t/m}^3$ , together with the bearing ratio at 2.5 mm penetration and the bearing ratio at 5.0 mm penetration for each specimen.
- b) A graph of compacted dry density versus compacted moisture content together with a plot of the zero air voids line or assumed zero air voids line.
- c) The dry density corresponding to the maximum point on the compacted dry density / moisture content curve as the CBR MDD to the nearest  $0.01 \text{ t/m}^3$ .
- d) The percentage moisture content corresponding to the CBR MDD on the compacted dry density / moisture content curve as the CBR OMC to the nearest 0.5%.
- e) Method of curve fitting, for example, hand drawn or cubic-spline,  $n^{\text{th}}$  order polynomial and so on.

7.2 CBR results:

- a) A semi logarithmic graph of bearing ratio versus compacted moisture content.
- b) BR 2.5 mm and BR 5.0 mm (refer to Table 4).
- c) The material CBR value which is the largest numerical value of either BR 2.5 mm or BR 5.0 mm (Refer to Table 4).
- d) Method of curve fitting, for example, hand drawn or cubic-spline,  $n^{\text{th}}$  order polynomial and so on.

7.3 Test / curing conditions:

- a) Test condition, that is, soaked or unsoaked.
- b) Duration of curing to the nearest hour.
- c) Method for determining the plasticity level (refer to Table 3), that is, test method or visual / tactile assessment.
- d) The compactive effort (modified) used.

7.4 The number of this Test Method, that is Q113B.

The following may be reported:

7.4.1 Additional information:

- a) Swell of each soaked specimen to the nearest 0.1% for values less than 10, otherwise to the nearest 1%.
- b) Final moisture content of each specimen after penetration (refer to Test Method AS 1289.2.1.1).

- c) The force-penetration graph of the specimen having the compacted moisture content closest to CBR OMC.

## **8 Notes on method**

- 8.1 Calibrate the force measuring device over its complete operating range. This will require further points near to zero in addition to those required by AS 2193.
- 8.2 For each test, select a force measuring device which is Class C for that part of its operating range which corresponds to the forces required to produce plunger penetrations of 2.5 mm and greater.
- 8.3 Where the applied force is measured using a device such as a load transducer, the penetration gauge may be affixed to the frame of the machine.
- 8.4 A material height gauge, which allows monitoring of the height of compacted material relative to the top of a CBR mould, can be made from a steel bar as follows:
  - 8.4.1 CBR Mould – Modified (Mod) compaction.  
Commencing at one end of the bar, measure, and mark distances of:
    - a) 20 mm and 25 mm for the acceptable range of the fourth layer
    - b) 50 mm and 45 mm for the acceptable range of the third layer
    - c) 72 mm and 67 mm for the acceptable range of the second layer, and
    - d) 96 mm and 91 mm for the acceptable range of the first layer.
  - 8.4.2 Mark the face with the compactive effort (Mod).
- 8.5 Before handling oil, the operator should consult the relevant SDS.
- 8.6 To straddle OMC, it may be necessary to remove water from one or more test portions by air drying or oven drying at 45 to 50°C.
- 8.7 Suitable intervals for moisture increments range from 1% for a gravel to 2 to 3% for a clay.
- 8.8 Where the liquid limit has not been determined in accordance with Test Methods Q104A or Q104D, use either a liquid limit from source records or an estimate based on a visual/tactile assessment for estimating the curing time for the CBR test portions.
- 8.9 In some very weak materials where the seating load causes significant penetration, this step can be omitted provided this variation to the method is reported.
- 8.10 Where zeroing the force measuring device indicator will invalidate the calibration of the device, do not zero the indicator and record the indicator reading as the seating deflection.

- 8.11 Obtain the value of the material's soil particle density for calculating the air voids lines using the method described in AS 1289.3.5.1 or assume based on previous tests. A rough check on the material soil particle density is to select the dry density and moisture content of the wettest data point, nominate a percent air voids (2% often gives a satisfactory result) and calculate an soil particle density as follows:

$$\rho_s = \frac{100\rho_d}{(100 - V_a) - \rho_d w}$$

- where
- $\rho_s$  = soil particle density (t/m<sup>3</sup>)
  - $\rho_d$  = dry density of material (t/m<sup>3</sup>)
  - $V_a$  = nominated air voids (%)
  - $w$  = moisture content expressed as a percentage of the mass of dry material

The material's soil particle density so derived is the assumed value.

- 8.12 Appropriate values of calculated dry density are the smallest and largest scale values used on the graph of calculated dry density versus initial moisture content.
- 8.13 Where the force measuring device indicator was not zeroed after the application of the seating load. Convert the seating deflection to applied force in newtons and subtract from each of the calculated values of applied force.
- 8.14 This characteristic may be due to surface irregularities, material behaviour or other causes.

**Table 1 – Dimensions and tolerances for CBR equipment**

Apparatus	Dimension	Tolerance
<b>CBR machine</b>		
Platen travel rate – loaded (mm/min)	1	± 0.2
<b>Penetration piston</b>		
Diameter (mm)	49.6	± 0.1
<b>Mould</b>		
Internal diameter (mm)	152	± 1
Height (mm)	178	± 1
<b>Perforated baseplate</b>		
Hole number	28	+5, -0
Hole diameter (mm)	3	± 0.2
<b>Spacer disc</b>		
Diameter (mm)	150	± 0.5
Height (mm)	61	± 0.25
<b>Stem and perforated plate</b>		
Diameter (mm)	150	± 0.5
Mass (g)	1000	± 25
Hole number	42	± 0
Hole diameter (mm)	3	± 0.2



Apparatus	Dimension	Tolerance
<b>Soaking weight</b>		
Mass (g)	4500	± 50
<b>Surcharge weight</b>		
Mass (g)	2250	± 25
Diameter (mm)	150	± 0.5
<b>Levelling plate</b>		
Diameter (mm)	151	0, -1
Height (mm)	20	minimum

**Table 2 – Dimensions and tolerances for rammers**

Apparatus	Dimension	Tolerance
<b>Rammer – standard</b>		
Face diameter (mm)	50	± 0.4
Drop (mm)	450	± 2.0
Mass (g)	4900	± 10

**Table 3 – Minimum curing time**

Plasticity	Minimum curing time (hours)
Sands and unbound material*	2
Low (LL ≤ 35%)	48
Medium (35 < LL ≤ 50%)	96 (4 days)
High (LL > 50%)	168 (7 days)

\* These can include naturally occurring sands and gravels, crushed rocks and manufactured materials with a fines (< 0.075 mm) content less than 12%.

**Table 4 – Reporting intervals for CBR**

CBR (%)	Reporting interval
≤ 5	nearest 0.5
> 5 to ≤ 20	nearest 1
> 20 to ≤ 50	nearest 5
> 50	nearest 10

## Test Method Q113C: California Bearing Ratio of soil at nominated levels of dry density and moisture content

### 1 Source

This Test Method applies the principles of AS 1289.6.1.1: *Determination of the California Bearing Ratio of a soil for a remoulded specimen*. It differs from this standard as follows:

- a) in that it requires taking compaction moisture samples before the commencement of compaction only
- b) limits the applied correction to the force – penetration curve to 0.5 mm, and
- c) minor changes to apparatus requirements.

### 2 Scope

This Test Method sets out the procedure for the single point determination of the CBR of soils. California Bearing Ratio is the ratio of the force required to cause a circular plunger of 1932 mm<sup>2</sup> area to penetrate the material for a specified distance, expressed as a percentage of a standard force. The standard forces used in this method are 13,200 and 19,800 newtons for penetrations of 2.5 and 5.0 mm respectively.

Prepare test specimens by compacting passing 19.0 mm material to a nominated dry density and nominated moisture content in accordance with Test Method Q145A. They are then tested either in a soaked or unsoaked condition. The test is performed under the following conditions, unless otherwise specified:

- unsoaked condition
- nominated relative moisture content 100% of OMC, and
- nominated relative compaction 100% of MDD.

This Test Method has been retained for testing Type 4 unbound material in accordance with [Technical Specification MRTS05 Unbound Pavements](#) or Western Queensland materials as defined in [Western Queensland Best Practice Guidelines](#), *WQ33 Material Sources in Western Queensland*.

### 3 Apparatus

Where appropriate, the working tolerances of apparatus are contained in Tables 1 and 2. Examples of mould, spacer disc and handle, stem and perforated plate, tripod for swell gauge are contained in AS 1289.6.1.1, Figures 1, 2, 3 and 5.

The following apparatus is required:

- 3.1 CBR machine, fitted with the following:
  - a) a moveable lower platen that travels at a uniform vertical upward rate of 1 mm/min when measured loaded
  - b) force measuring device, at least Class C as defined in AS 2193 for the range of forces used in this test and capable of indicating seating loads of 50 N and 250 N (Notes 8.1 and 8.2)
  - c) penetration piston, having a diameter of 49.6 mm and about 190 mm long, having provision for affixing a suitable penetration gauge (Note 8.3), and

- d) penetration gauge, such as a dial gauge, conforming to the requirements of ISO 463 or JIS B 7503, with a resolution of 0.01 mm and a travel of 25 mm, or a displacement transducer of at least equal performance.
- 3.2 Mould assembly, comprising a cylindrical metal mould having an internal diameter of 152 mm and a height of 178 mm, two detachable baseplates and a removable collar having a height of about 60 mm. One baseplate (perforated baseplate) should have 28 x 3 mm diameter holes uniformly distributed over the area of the plate.
- 3.3 Spacer disc, having a diameter of 150 mm and a height of 61 mm.
- 3.4 Stem and perforated plate, having a diameter of 150 mm, mass of 1000 g and with 42 x 3 mm diameter holes uniformly distributed over the plate.
- 3.5 Soaking weight, having a mass of 4500 g and a diameter of approximately 150 mm, with a centre hole of approximately 55 mm diameter. The surface of the weight in contact with the perforated plate is to be centrally recessed to a minimum depth of 2 mm for a diameter of approximately 120 mm.
- 3.6 Surcharge weights, two metal weights each having a mass of 2250 g and a diameter of 150 mm, with a centre hole of approximately 55 mm diameter.
- 3.7 Swell gauge, consisting of a tripod and a suitable gauge, for example, a dial gauge, conforming to the requirements of ISO 463 or JIS B 7503, with a resolution of 0.01 mm and a travel of 25 mm.
- 3.8 Setting piece, if swell is to be measured and the swell gauge is removed from the mould during soaking, to set the reading on the gauge attached to the tripod prior to each reading of the swell gauge.
- 3.9 Balance of suitable capacity, having a resolution of at least 1 g and with a limit of performance within the range of  $\pm 5$  g.
- 3.10 Steel rammer, having a 50 mm diameter face. For standard compactive effort, a rammer with a drop mass of 2700 g and a drop height of 300 mm.
- 3.11 Sieves, 19.0 mm and 9.50 mm conforming to ISO 3310.
- 3.12 Water bath, of sufficient depth to immerse the moulded specimen in water.
- 3.13 Sample extruder, such as a jack, lever frame or other device suitable for extracting compacted soil specimens from the mould.
- 3.14 Material height gauge. A flat steel bar, about 250 mm long, 25 mm wide and 1-3 mm thick is satisfactory (Note 8.4).

#### **4 Materials**

The following materials are required:

- 4.1 Filter paper, a coarse filter paper such as Whatman No. 1.

## 5 Procedure

The procedure shall be as follows:

### 5.1 Sample Preparation

- 5.1.1 Prepare the bulk sample in accordance with Section 4 of Test Method Q101 to produce a representative subsample of appropriate size.
- 5.1.2 Further prepare the material by screening the subsample on a 19.0 mm sieve in accordance with Q101, Steps 5.2.1 to 5.2.2. Ensure that any aggregations are broken up to pass a 9.50 mm sieve. Discard any material retained on the 19.0 mm sieve and thoroughly remix the material passing the 19.0 mm sieve.
- 5.1.3 Prepare representative test portions of the sieved material in accordance with Test Method Q101, Steps 5.2.3 to 5.2.5 as follows:
  - a) the required number of test portions for compaction and determine the mass of each test portion ( $m_1$ )
  - b) test portion for hygroscopic moisture content, and
  - c) four or more test portions to determine the OMC and MDD.
- 5.1.4 Determine the hygroscopic moisture content ( $w_1$ ) of the test portion prepared in Step 5.1.3 b) in accordance with Test Method AS 1289.2.1.1.
- 5.1.5 Determine the OMC and MDD using the test portions prepared in Step 5.1.3 c) in accordance with Test Method Q142A, using a Type A mould and using the specified curing time for the material (Test Method Q255 Table 1).

### 5.2 Curing

- 5.2.1 Calculate the target moisture content ( $w_t$ ) and target dry density to achieve the nominated relative compaction and nominated relative moisture content in accordance with Test Method Q145A.
- 5.2.2 Calculate the dry mass of each test portion ( $m_2$ ) and mass of mixing water to be added ( $m_3$ ), then mix and cure each the test portion in accordance with Test Method Q255.

### 5.3 Compaction

- 5.3.1 Undertake all necessary calculations, mould preparation and compaction of the test portion in accordance with Test Method Q145A to achieve the nominated relative compaction and nominated relative moisture content. Compacting each specimen in three equal layers for standard compaction.
- 5.3.2 When testing the compacted material in the soaked condition, soak the compacted material in accordance with Subsection 5.4.
- 5.3.3 When testing the compacted material in the unsoaked condition, penetrate the compacted material in accordance with Subsection 5.5.

### 5.4 Soaking

- 5.4.1 Place a filter paper on the compacted material. Centrally locate the stem and perforated plate together with a soaking weight on the filter paper.
- 5.4.2 If measurement of swell is required, undertake the measurement as follows:
  - a) If the swell gauge is to be removed from the mould during soaking:
    - i. set the reading on the gauge against the setting piece

- ii. obtain an initial reading by placing the tripod of the swell gauge on the top of the mould so that the contact point of the dial gauge is in contact with the highest point of the stem
    - iii. mark reference points to permit relocation of swell gauge to the same spots after soaking, and
    - iv. record the dial gauge reading ( $r_1$ ) before removing the swell gauge.
  - b) If the swell gauge is not removed from the mould during soaking:
    - i. obtain an initial reading by placing the tripod of the swell gauge on the top of the mould so that the contact point of the dial gauge is in contact with the highest point of the stem, and
    - ii. record the dial gauge reading ( $r_1$ ).
- 5.4.3 Place the mould in the water bath, allowing free access of water to the top and bottom of the specimen. Soak the specimen for  $96 \pm 4$  hours, maintaining the water level above the mould during this period.
- 5.4.4 If measurement of swell is required, after soaking is completed but prior to removing the mould from the water bath, undertake the measurement as follows:
- a) If the swell gauge was removed from the mould during soaking:
    - i. set the reading on the gauge against the setting piece to the same value in Step 5.4.2 a) i.
    - ii. place the tripod of the swell gauge at the reference points marked in Step 5.4.2 a) iii., and
    - iii. record the dial gauge reading ( $r_2$ ) before removing the swell gauge.
  - b) If the swell gauge was not removed from the mould during soaking:
    - i. record the dial gauge reading ( $r_2$ ) before removing the swell gauge.
- 5.4.5 Remove the mould from the water bath and tilt the mould to pour off any excess water. Return it to the upright position and allow draining for 15 minutes. Do not disturb the surface of the specimen during the removal of water.
- 5.4.6 Remove the soaking weight and the stem and perforated plate from the mould.
- 5.4.7 Penetrate the specimen in accordance with Subsection 5.5.
- 5.5 Penetration**
- 5.5.1 Centrally locate the two surcharge weights on the compacted material in the mould.
- 5.5.2 Position the mould on the platen of the CBR machine so that the mould is located centrally under the penetration piston and the piston almost touches the surface of the material.
- 5.5.3 Zero the force measuring device indicator and seat the penetration piston, with the smallest possible load, not exceeding 50 N for an expected CBR equal to or less than 30% and 250 N for expected CBR greater than 30% (Note 8.5).
- 5.5.4 Zero the force measuring device indicator and penetration gauge (Note 8.6).
- 5.5.5 Commence the penetration of the specimen and record the force measuring device indicator readings for every 0.5 mm penetration to a minimum penetration of 7.5 mm.

- 5.5.6 Remove the mould from the CBR machine. Remove the surcharge weights. Extrude the compacted soil from the mould and obtain the final moisture content ( $w_2$ ) as follows:
- a) For compacted material penetrated in the soaked condition:
    - i. Remove the filter papers and obtain a moisture sample to a depth of 30 mm from the end of the specimen that contains the penetration depression.
    - ii. Obtain a second moisture sample from a uniform section through the entire depth of the remainder of the specimen.
    - iii. Determine the moisture content ( $w_2$ ) of each moisture sample in accordance with Test Method AS 1289.2.1.1.
  - b) For compacted material penetrated in the unsoaked condition:
    - i. Obtain a moisture sample from a uniform section through the entire depth of the specimen.
    - ii. Determine the moisture content ( $w_2$ ) of the moisture sample in accordance with Test Method AS 1289.2.1.1.

## 6 Calculations

Calculations shall be as follows:

- 6.1 Using the achieved moisture content, calculate the achieved dry density, achieved relative compaction and achieved relative moisture content for the specimen in accordance with Test Method Q145A.
- 6.2 Compare the achieved dry density and target dry density. If they differ by more than 0.02 t/m<sup>3</sup>, discard the specimen, and repeat the preparation to Q145A for the nominated conditions.
- 6.3 Compare the achieved moisture content and the target moisture content. If they differ by more than 1.0%, discard the specimen, and repeat the preparation to Q145A for the nominated conditions.
- 6.4 Calculate the swell as follows:

$$s = \left( \frac{r_2 - r_1}{117} \right) 100$$

where

$s$	=	swell (%)
$r_2$	=	final dial gauge reading (mm)
$r_1$	=	initial dial gauge reading (mm)

- 6.5 Calculate the bearing ratio at 2.5 mm and 5.0 mm penetration as follows:
  - 6.5.1 Convert the force indicator readings to applied forces in newtons using the appropriate calibration for the force measuring device (Note 8.7).
  - 6.5.2 Plot the applied forces against the corresponding penetration values and draw a smooth curve through the points.
  - 6.5.3 When the force-penetration curve commences with a concave upward portion that transitions to a linear portion (refer to AS 1289.6.1.1 Figure 6, curve 3 and Note 8.8), then transitions to concave downward, adjust the penetration scale as follows:
    - a) Draw a tangent through the steepest part of the curve to intersect the penetration axis.

- b) The intercept with the penetration (x) axis is the new origin provided its value does not exceed 0.5 mm.
  - c) Where the intercept exceeds 0.5 mm, the new origin is 0.5 mm.
  - d) Adjust the 2.5 mm and 5.0 mm values in relation to the re-designated origin.
- 6.5.4 When the force-penetration curve commences with a linear portion and may transition to concave downward (refer to AS 1289.6.1.1 Figure 6, curve 2), no adjustment is made to the penetration scale.
- 6.5.5 When the force-penetration curve commences with a concave upward portion that does not transition to a linear portion (refer to AS 1289.6.1.1 Figure 6, curve 1), no adjustment is made to the penetration scale.
- 6.5.6 Determine the values of applied force ( $f_{2.5}$  and  $f_{5.0}$ ) corresponding to the adjusted 2.5 mm and 5.0 mm penetrations.
- 6.5.7 Calculate the bearing ratio at 2.5 mm and 5.0 mm penetrations and record these ratios as  $BR_{2.5}$  and  $BR_{5.0}$  as follows:

$$BR_{2.5} = \frac{f_{2.5}100}{13200}$$

$$BR_{5.0} = \frac{f_{5.0}100}{19800}$$

- where
- $BR_{2.5}$  = Bearing Ratio corresponding to 2.5 mm penetration (%)
  - $BR_{5.0}$  = Bearing Ratio corresponding to 5.0 mm penetration (%)
  - $f_{2.5}$  = applied force corresponding to 2.5 mm penetration (N)
  - $f_{5.0}$  = applied force corresponding to 5.0 mm penetration (N)

## 7 Reporting

The following shall be reported:

- 7.1 Moisture / density relationship results:
- a) MDD to the nearest 0.01 t/m<sup>3</sup>
  - b) OMC to the nearest 0.5%
- 7.2 Compaction results:
- a) The following in accordance with Test Method Q145A:
    - i. nominated relative compaction and nominated relative moisture content
    - ii. target dry density and target moisture content
    - iii. achieved dry density and achieved moisture content, and
    - iv. achieved relative compaction and achieved relative moisture content.
- 7.3 CBR results:
- a)  $BR_{2.5}$  and  $BR_{5.0}$  (refer to Table 3).
  - b) The material CBR value which is the largest numerical value of either  $BR_{2.5}$  or  $BR_{5.0}$  (refer to Table 3).
- 7.4 Test / curing conditions:

- a) Test condition, that is, soaked or unsoaked.
- b) The compactive effort (standard) used.
- c) For soaked specimens:
  - i. Duration of soaking, that is, four days.
  - ii. Swell to the nearest 0.1% for values less than 10%, otherwise to the nearest 1%, and
  - iii. Moisture content after penetration of the penetrated end of the specimen and the moisture content of the remainder (refer to Test Method AS 1289.2.1.1).
- d) For unsoaked specimens:
  - i. Moisture content after penetration (refer to Test Method AS 1289.2.1.1).

7.5 The number of this Test Method, that is Q113C.

The following may be reported:

7.6 Additional information:

- a) The force-penetration graph of the specimen.

## **8 Notes on method**

- 8.1 Calibrate the force measuring device over its complete operating range. This will require further points near to zero in addition to those required by AS 2193.
- 8.2 A force measuring device is to be used which is at least Class C as defined in AS 2193 for that part of its operating range which corresponds to the forces required to produce plunger penetrations of 2.5 mm and greater.
- 8.3 Where the applied force is measured using a device such as a load transducer, the penetration gauge may be affixed to the frame of the machine.
- 8.4 A material height gauge, which allows monitoring of the height of compacted material relative to the top of a CBR mould, can be made from a steel bar as follows:
  - 8.4.1 CBR Mould – Standard (Std) compaction.

Commencing at one end of the bar, measure, and mark distances of:

    - a) 39 mm and 34 mm for the acceptable range of the second layer, and
    - b) 78 mm and 73 mm for the acceptable range of the first layer.
  - 8.4.2 Mark face with the appropriate compactive effort (Std).
- 8.5 In some very weak materials where the seating load causes significant penetration. Omit this step provided this variation to the method is reported.
- 8.6 Where zeroing the force measuring device indicator will invalidate the calibration of the device, do not zero the indicator and record the indicator reading as the seating deflection.
- 8.7 Where the force measuring device indicator was not zeroed after the application of the seating load. Convert the seating deflection to applied force in newtons and subtract from each of the calculated values of applied force.
- 8.8 This characteristic may be due to surface irregularities, material behaviour or other causes.



**Table 1 – Dimensions and tolerances for CBR equipment**

<b>Apparatus</b>	<b>Dimension</b>	<b>Tolerance</b>
<b>CBR machine</b>		
Platen travel rate – loaded (mm/min)	1	± 0.2
<b>Penetration piston</b>		
Diameter (mm)	49.6	± 0.1
<b>Mould</b>		
Internal diameter (mm)	152	± 1
Height (mm)	178	± 1
<b>Perforated baseplate</b>		
Hole number	28	+5, -0
Hole diameter (mm)	3	± 0.2
<b>Spacer disc</b>		
Diameter (mm)	150	± 0.5
Height (mm)	61	± 0.25
<b>Stem and perforated plate</b>		
Diameter (mm)	150	± 0.5
Mass (g)	1000	± 25
Hole number	42	± 0
Hole diameter (mm)	3	± 0.2
<b>Soaking weight</b>		
Mass (g)	4500	± 50
<b>Surcharge weight</b>		
Mass (g)	2250	± 25
Diameter (mm)	150	± 0.5
<b>Levelling plate</b>		
Diameter (mm)	151	0, -1
Height (mm)	20	minimum

**Table 2 – Dimensions and tolerances for rammers**

<b>Apparatus</b>	<b>Dimension</b>	<b>Tolerance</b>
<b>Rammer – standard</b>		
Face diameter (mm)	50	± 0.4
Drop (mm)	300	± 2.0
Mass (g)	2700	± 10

**Table 3 – Reporting intervals for CBR**

<b>CBR (%)</b>	<b>Reporting interval</b>
≤ 5	nearest 0.5
> 5 to ≤ 20	nearest 1
> 20 to ≤ 50	nearest 5
> 50	nearest 10

## Test Method Q114B: Insitu California Bearing Ratio - dynamic cone penetrometer

### 1 Source

This Test Method is based on AS 1289.6.3.2: *Soil strength and consolidation tests - Determination of the penetration resistance of a soil – 9 kg dynamic cone penetrometer test*. There are some minor procedural differences and conversion of results to CBR values rather than number of blows per 25 mm.

The conversion of test data to CBR values is based on data from Scala AJ (January 1956) *Simple Methods of Flexible Pavements Design Using Cone Penetrometers*, Proceedings Second Australia-New Zealand Conference Soil Mechanics and Foundation Engineering, Christchurch, NZ, and a relationship first published in Queensland Main Roads, *Insitu California bearing Ratio (Dynamic Cone Penetrometer)*, Materials Testing Manual 3<sup>rd</sup> Edition, Test Method Q114B-1978.

### 2 Scope

This Test Method sets out the procedure to determine the insitu CBR of soils and fine crushed rock. The method has application for fine grained materials since the presence of rock particles, 6 mm and larger, may interfere with the test.

The test gives a continuous record of bearing value with depth below an existing surface, usually without the need to excavate to the depth at which the readings are acquired.

### 3 Apparatus

The working tolerances and an example of the standard dynamic cone penetrometer are contained in AS 1289.6.3.2 Figure 1.

The following apparatus is required:

- 3.1 Standard dynamic cone penetrometer (DCP) consisting of three parts as follows:
  - a) Sliding drop hammer, with a mass of 9000 g and a free vertical fall of 510 mm on a 16 mm diameter shaft fitted with a stop and anvil. Check the travel of the drop hammer before each test to ensure the maintenance of the correct drop height.
  - b) Steel rod(s), 16 mm diameter and not exceeding 1500 mm in length that attach securely to the anvil, and
  - c) Hardened steel cone, with a 30° included angle, attached securely to the steel rod and have a diameter of 20 mm.
- 3.2 Extractor, such as a modified vehicle jack.
- 3.3 Displacement measuring device, such as a steel rule or tape with a resolution not exceeding 1 mm.

### 4 Test site preparation

- 4.1 Remove any loose material and vegetation from around the test site to create a flat and level surface to undertake the test and measure the penetration of the steel cone.
- 4.2 Where there is an overlying layer of clay, silt, sand or fine gravel up to 6 mm in particle size, it is possible to test through the layer.

- 4.3 Where there is an overlying layer of medium gravel or other coarser material, excavate a hole in the overlying layer of sufficient size to perform the test.

## 5 Test procedure

The procedure shall be as follows:

- 5.1 Holding the penetrometer vertically, seat the cone such that the widest part of the cone is embedded to a depth of 50 mm using part hammer drops if needed (refer to Figure 1). Zero the displacement measuring device or take a zero reading (Note 8.1).
- 5.2 Drive the cone into the ground by raising the hammer to the stop and allowing it to fall freely striking the anvil. Record the penetration to the nearest millimetre, ensuring the displacement measuring device remains vertical.
- 5.3 Repeat Step 5.2 until either:
- required depth is achieved, or
  - full length of rod(s) is used, or
  - eight consecutive full hammer drops give a cumulative penetration less than 20 mm.
- 5.4 At the completion of the test, remove the steel rod and cone using the extractor jack. Do not back hammer to remove the steel rod and cone as this may alter the drop height.
- 5.5 If required, obtain a sample of soil and determine the moisture content in accordance with Test Method AS 1289.2.1.1 or record the moisture condition of the soil.

## 6 Calculations

Calculate the equivalent California Bearing Ratio value as follows:

- 6.1 Plot the penetration (mm) against number of hammer blows.
- 6.2 Analyse the penetration against number of hammer blows plot to identify the layers present and determine for each layer the following (Note 8.2):
- the number of the first blow ( $N_a$ ) and penetration recorded ( $P_a$ ) for the layer, and
  - the number of the final blow ( $N_b$ ) and penetration recorded ( $P_b$ ) for the layer.
- 6.3 Determine the penetration index ( $r$ ) for each layer as follows:

$$r = \frac{P_b - P_a}{N_b - N_a}$$

- where
- $r$  = penetration index (mm/blow)
  - $P_b$  = penetration recorded at blow b (mm)
  - $P_a$  = penetration recorded at blow a (mm)
  - $N_b$  = number of the final blow (b) for the layer
  - $N_a$  = number of the first blow (a) for the layer

6.4 Calculate the equivalent CBR value for each layer as follows:

$$CBR = 294.95r^{-1.129}$$

where  $CBR$  = equivalent CBR value  
 $r$  = penetration index (mm/blow)

## 7 Reporting

The following shall be reported:

- 7.1 Reference point for all layer measurements, such as the surface.
- 7.2 Depth from the reference point for the start and end of each layer.
- 7.3 Thickness of each layer (mm), if required.
- 7.4 Equivalent CBR value for each layer (refer Table 1).
- 7.5 Moisture content of the soil or the moisture condition of the soil, that is, wet, moist or dry, if required, and
- 7.6 The number of this Test Method, that is Q114B.

## 8 Notes on method

- 8.1 For the purposes of easier data entry and calculation, it is simpler for the displacement measuring device to be configured so the zero reading is 50 mm and all subsequent readings increase with penetration.
- 8.2 Where multiple layers are identified, the final blow and penetration recorded for the upper layer will be the same as the initial blow and penetration for the lower layer.

**Table 1 – Reporting intervals for equivalent CBR values**

Equivalent CBR value (%)	Reporting interval
≤ 5	nearest 0.5 units
> 5 to ≤ 20	nearest 1 unit
> 20 to ≤ 50	nearest 5 units
50 to 60	nearest 10 units
> 60	report as > 60

Figure 1 – Initial embedment of DCP

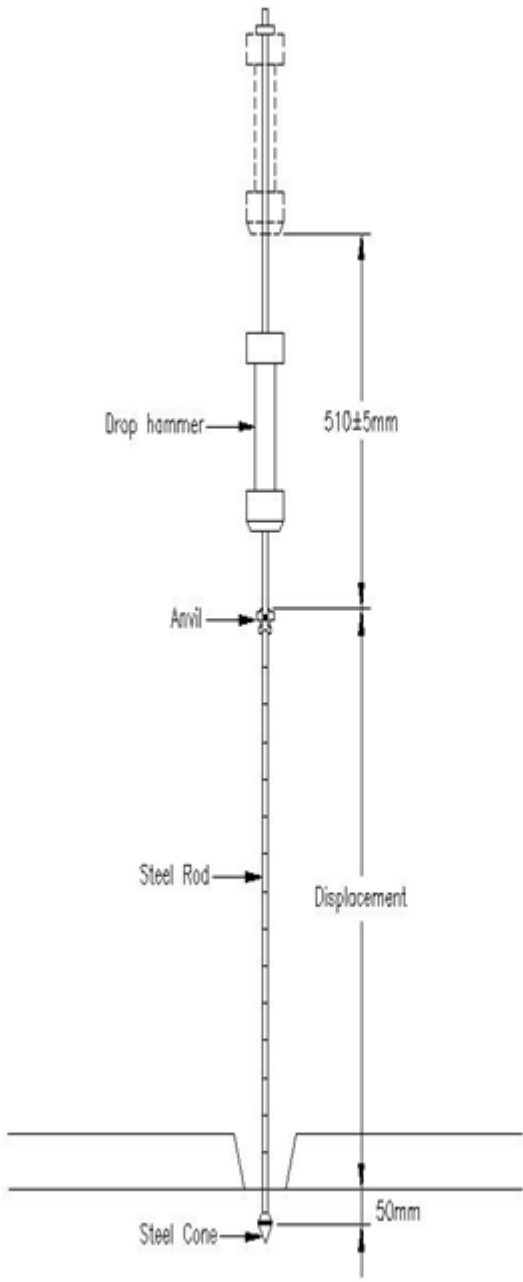

## Test Method Q115: Unconfined compressive strength of stabilised materials

### 1 Source

This Test Method was developed in-house using techniques evolved through internal departmental research investigations.

### 2 Scope

This Test Method describes the procedure to determine the UCS of compacted specimens of soils, crushed rock and recycled material blends which have been either modified or stabilised with a stabilising agent or are in their natural state.

The Test Method has application in testing field-moulded specimens, testing laboratory-moulded specimens of soils or recycled material blends or testing core specimens removed from a stabilised material by dry coring.

### 3 Apparatus

Where appropriate, the working tolerances of apparatus are contained in Tables 1 and 2.

The following apparatus is required:

- 3.1 Sample extractor, such as a jack, lever frame or other suitable device for extruding compacted specimens from the mould.
- 3.2 Calliper, with a resolution not exceeding 0.1 mm and conforming to the requirements of ISO 13385-1 or JIS B 7507.
- 3.3 Capping jig, suited to 105 mm diameter specimens and conforming to the requirements of AS 1012.9.
- 3.4 CBR machine, fitted with the following:
  - a) a moveable lower platen that travels at a uniform vertical upward rate of 1 mm/min when measured loaded
  - b) an upper platen that has a spherical seat, and
  - c) force measuring device, at least Class C as defined in AS 2193 for that part of its operating range which corresponds to the maximum force applied to any test specimen.
- 3.5 Engineer's square, with a minimum blade length of 100 mm.
- 3.6 Steel rule.

### 4 Materials

The following materials are required:

- 4.1 Capping compound, special high-strength cementitious material such as dental plaster, low heat mortar or special gypsum plaster (Note 11.1). capable of providing a compressive strength > 5 MPa after one hour, when tested before use as follow:
  - Prepare as recommended by the manufacturer and compact into cube mould using a spatula. Using a cube mould of dimension 50 mm to 75 mm, demould specimen after 0.5 hour and test one hour after casting in accordance with Test Method AS 1012.9.

## **5 Specimen preparation**

The specimen shall be prepared as follows:

### **5.1 Laboratory mixing**

- 5.1.1 Prepare the material in accordance with Test Method Q251A to obtain at least nine specimens for testing (Notes 11.2 and 11.3).

### **5.2 Field mixing**

For field mixed materials sampled from either an insitu stabilising process or a plant-mixed process the procedure shall be as follows:

- 5.2.1 Prepare the material in accordance with Test Method Q251B to produce at least three specimens for testing.

### **5.3 Soils or recycled material blends**

For soils sampled using an appropriate method or recycled material blends sampled from stockpile the procedure shall be as follows:

- 5.3.1 Prepare the material in accordance with Test Method Q251C to produce at least three specimens for testing.

### **5.4 Core specimens**

- 5.4.1 Obtain at least three core samples about 100 mm diameter in accordance with Test Method Q070.
- 5.4.2 Prepare the core samples as detailed in Test Method Q070 Section 7 to obtain three specimens with a height / diameter ratio of at least 1.1 for testing (Note 11.2).
- 5.4.3 Cap and test the specimens in accordance with Sections 7 and 8.

## **6 Demoulding and curing**

The demoulding and curing shall be as follows:

- 6.1 At the completion of moulding, demould any specimens that were compacted using the host material only. These specimens are ready for capping and testing. Where there is any delay in testing, seal the specimens in plastic wrapping to prevent moisture loss.
- 6.2 For specimens containing stabilising agent, demould and cure these in accordance with Test Method Q135B.

## **7 Capping**

The capping shall be as follows:

- 7.1 At the end of the specified curing period, examine the condition of each specimen and cap any specimen end which meets one or more of the following criteria:
- 7.1.1 The surface was not levelled using the levelling plate or compacted against the mould baseplate.
- 7.1.2 The end is more than 2 degrees out of square with the longitudinal axis.
- 7.1.3 Edge breaks, small depressions or other irregularities exist which, when considered together, would cause the force to be applied over 90 percent or less of the surface area.
- 7.2 Remove surface water from any end to be capped and apply a thin cap of capping compound using the capping jig.



- 7.3 Allow each cap to harden for 1 hour after capping. To minimise moisture loss from the specimen, either cover the exposed surfaces with plastic wrapping or place the specimen in a sealed container.

## 8 Testing

The testing shall be as follows:

- 8.1 Measure two diameters of each test specimen to the nearest 0.1 mm ( $d_i$ ).
- 8.2 For core specimens, measure the height ( $h$ ) of each core specimen to the nearest 1 mm.
- 8.3 Place the test specimen centrally on the lower platen of the CBR machine such that the top of the specimen is uppermost.
- 8.4 Apply a compressive force to the specimen and record the maximum applied force ( $F$ ).

## 9 Calculations

Calculations shall be as follows:

- 9.1 For all specimens:
- 9.1.1 Calculate the mean diameter of each test specimen ( $D$ ).
- 9.1.2 Calculate the unconfined compressive strength for each specimen as follows:

$$UCS = \frac{1273F}{D^2}$$

where  $UCS$  = unconfined compressive strength (MPa)  
 $F$  = applied force at failure (kN)  
 $D$  = mean specimen diameter (mm)

- 9.1.3 Calculate the mean unconfined compressive strength.
- 9.2 For laboratory mixed material:
- 9.2.1 Calculate the following for each specimen in accordance with Test Method Q145A:
- achieved moisture content and the achieved relative moisture content, and
  - achieved dry density and the achieved relative compaction.
- 9.2.2 Compare the achieved dry density and target dry density. If they differ by more than 0.01 t/m<sup>3</sup>, repeat the test.
- 9.2.3 Compare the achieved moisture content and the target moisture content. If they differ by more than 0.5%, repeat the test.
- 9.3 For core specimens:
- 9.3.1 Calculate specimen height / diameter ratio for each test specimen as follows:

$$x = \frac{h}{D}$$

where  $x$  = specimen height / diameter ratio  
 $h$  = height of test specimen  
 $D$  = mean specimen diameter (mm)

9.3.2 Calculate the correction factor for each specimen as follows:

$$f_c = -0.42 + 2.83x - 2.233x^2 + 0.8x^3 - 0.1067x^4$$

where  $f_c$  = correction factor for the specimen height/diameter ratio  
 $x$  = specimen height / diameter ratio

9.3.3 Calculate the corrected unconfined compressive strength for each specimen as follows (Note 11.4):

$$UCS_c = \frac{UCS \cdot f_c}{0.899651}$$

where  $UCS_c$  = corrected unconfined compressive strength (MPa)  
 $UCS$  = unconfined compressive strength (MPa)  
 $f_c$  = correction factor for the specimen height / diameter ratio

9.3.4 Calculate the mean corrected unconfined compressive strength.

## 10 Reporting

The following shall be reported:

10.1 General information:

- a) Sample type (that is, laboratory mixed, field mixed, soil, recycled material or cores).
- b) Whether specimens were tested capped or uncapped.

10.2 For laboratory mixed material:

- a) Age of specimens (days).
- b) UCS of each specimen to the nearest 0.05 MPa and the mean UCS to the nearest 0.05 MPa.
- c) A plot of mean UCS versus stabilising agent content.

10.3 For field mixed material:

- d) Age of specimens (days)
- e) UCS of each specimen to the nearest 0.05 MPa and the mean UCS to the nearest 0.05 MPa.

10.4 For soils or recycled materials:

- a) Age of specimens (days)
- b) UCS of each specimen to the nearest 0.05 MPa and the mean UCS to the nearest 0.05 MPa.

10.5 For core specimens:

- a) Specimen diameter to the nearest 0.1 mm.
- b) Specimen height to the nearest 1 mm.
- c) UCS of each specimen to the nearest 0.05 MPa.
- d) Corrected UCS of each specimen to the nearest 0.05 MPa and the mean corrected UCS to the nearest 0.05 MPa.

10.6 The number of this Test Method, that is Q115.

## 11 Notes on method

- 11.1 Before handling capping compounds, the operator should consult the relevant SDS.
- 11.2 For cement and cementitious blends, sufficient test portions should be available to straddle the UCS range in increments of 0.5 to 1.0% stabilising agent content. This will sometimes require more than three compaction test portions.
- 11.3 For lime stabilisation, sufficient test portions should be available to straddle a range of lime contents in increments of 2.0% stabilising agent content. This will usually require five compaction test portions.
- 11.4 The value of 0.899296 is calculated using the height / diameter relationship for a height / diameter ratio of 1.1.

**Table 1 – Dimensions and tolerances of testing apparatus**

Apparatus	Dimension	Tolerance
<b>CBR Machine</b>		
Platen travel rate – loaded (mm/min)	1	± 0.2

## Test Method Q118: Bitumen content of stabilised material

### 1 Source

This Test Method applies the principles of AS/NZS 2891.3.1: *Bitumen content and aggregate grading - Reflux method*.

### 2 Scope

This Test Method describes the procedure for the determination of the bitumen content of a bitumen stabilised material by solvent extraction.

### 3 Apparatus

Where appropriate, the working tolerances of apparatus are contained in Table 1.

The following apparatus is required:

- 3.1 Balances:
  - a) Balance of suitable capacity, with a resolution of at least 0.1 g and with a limit of performance within the range of  $\pm 0.5$  g.
  - b) Balance of suitable capacity, with a resolution of at least 0.001 g and with a limit of performance within the range of  $\pm 0.005$  g.
- 3.2 Centrifuge, an electric centrifuge capable of holding at least two 15 mL aliquots.
- 3.3 Hotplate, capable of maintaining a temperature of 305°C (Note 8.1).
- 3.4 Fume cupboard.
- 3.5 Flask, conical flask of 2 L capacity with a ground glass neck of at least 55 mm diameter and fitted with a stopper.
- 3.6 Condenser, double surface condenser to fit the neck of the flask.
- 3.7 Beaker, of at least 100 mL capacity.
- 3.8 Containers, two flat-bottomed aluminium containers of approximate dimensions 100 mm diameter and 75 mm depth and equipped with tightly fitting slip-on lids.
- 3.9 Sieve, 2.36 mm conforming to ISO 3310.
- 3.10 Sieve brush.
- 3.11 Steel mortar and rubber pestle.

### 4 Materials

The following materials are required:

- 4.1 Solvent, toluene commercial grade (Notes 8.1 and 8.2).

### 5 Procedure

The test procedure shall be as follows:

- 5.1 Prepare a bulk sample in accordance with Section 4 of Test Method Q101 to produce a representative subsample of about 1200 g.
- 5.2 Sieve the subsample over a 2.36 mm sieve.

- 5.3 Transfer the material retained on the 2.36 mm sieve to a mortar and grind with a rubber pestle to break up any soil aggregations.
- 5.4 Sieve the ground material over the 2.36 mm sieve.
- 5.5 Continue the sieving and grinding cycle in Steps 5.3 and 5.4 until retaining only clean aggregate on the 2.36 mm sieve.
- 5.6 Remix the material retained on the 2.36 mm sieve and the material passing the 2.36 mm sieve.
- 5.7 Weigh the flask with stopper and record the mass to the nearest 0.1 g ( $m_1$ ).
- 5.8 With the flask held at an angle of about 45 degrees, transfer the subsample to the flask. Weigh the flask with stopper and record the mass to the nearest 0.1 g ( $m_2$ ).
- 5.9 Add a quantity of solvent to the flask at least equivalent in mass to the mass of the subsample.
- 5.10 Fit the reflux condenser to the flask and gently warm the flask and contents on the hotplate in the fume cupboard to dissolve the bitumen (Note 8.3). Shake the flask frequently during this refluxing operation to prevent bitumen from caking on the bottom of the flask.
- 5.11 Allow the flask to cool to room temperature with the condenser still in position. Remove the condenser and fit the stopper.
- 5.12 Weigh the flask and stopper and record the mass to the nearest 0.1 g ( $m_3$ ).
- 5.13 Perform the following procedure on two aliquots:
  - 5.13.1 Using the beaker, transfer an aliquot of at least 15 mL of the solution from the flask to the centrifuge tube(s). Stopper the tube(s) immediately and centrifuge to separate any suspended mineral matter.
  - 5.13.2 Weigh a container with lid and record the mass to the nearest 0.001 g ( $m_4$ ).
  - 5.13.3 Pour the supernatant liquid from the centrifuge tube(s) into the container, taking care not to disturb the settled mineral matter, and fit the lid. Weigh the container immediately and record the mass to the nearest 0.001 g ( $m_5$ ).
  - 5.13.4 Remove the lid and place the container on the hotplate maintained at a temperature of  $305 \pm 10^\circ\text{C}$  in the fume cupboard to evaporate the solvent. Continue the heating for two minutes after fumes are first seen to rise from the bitumen (Note 8.4).
  - 5.13.5 Remove the container from the hotplate, replace the lid and allow the container to cool to room temperature.
  - 5.13.6 Weigh the container and lid and record the mass to the nearest 0.001 g ( $m_6$ ).

## 6 Calculations

Calculations shall be as follows:

- 6.1 Calculate the bitumen content based on each aliquot as follows:

$$B_a = \frac{(m_3 - m_2)(m_6 - m_4)100}{(m_5 - m_6)(m_2 - m_1)}$$

where	$B_a$	=	bitumen content based on one aliquot (%)
	$m_3$	=	mass of flask and stopper, test portion and solvent (g)
	$m_2$	=	mass of flask and stopper and test portion (g)
	$m_6$	=	mass of container and lid and bitumen (g)
	$m_4$	=	mass of container and lid (g)
	$m_5$	=	mass of container and lid and supernatant liquid (g)
	$m_1$	=	mass of flask and stopper (g)

- 6.2 Provided the difference between the bitumen contents based on the two aliquots is less than 0.06%, calculate the bitumen content of the sample (B) as the mean of the two results. Where the difference between the bitumen contents based on the two aliquots is 0.06% or greater, repeat Subsection 5.13

## 7 Reporting

The following shall be reported:

- 7.1 Bitumen content of the sample to the nearest 0.1%, and  
7.2 The number of this Test Method, that is Q118.

## 8 Notes on method

- 8.1 Before handling toluene, the operator should consult the relevant SDS.
- 8.2 An alternative solvent may be used provided that:
- it meets occupational health and safety requirements; and
  - it can be demonstrated that use of the solvent achieves equivalent test results.
- 8.3 If the aggregate in the bottom of the flask is clean, then all the bitumen has been dissolved. If the aggregate retains a coating of bitumen then continue the refluxing until the aggregate is clean. For materials containing slag or other absorptive type aggregates, it may be necessary to heat the mixture for periods up to eight hours to extract all traces of absorbed or occluded bitumen.
- 8.4 Depending on the type of bitumen within the sample and/or container size, it may be necessary to vary the temperature of the hotplate and time of fuming of the bitumen film. The appropriate hotplate temperature and fuming time can be determined by calibrating against solutions of known bitumen content.

**Table 1 – Working tolerances for apparatus**

Apparatus	Dimension	Tolerance
<b>Hotplate</b>		
Temperature distribution (°C)	305	± 10

## Test Method Q120B: Organic content of soil - loss on ignition

### 1 Source

This Test Method was developed in-house with reference to the procedures described in 'A Text-Book of Quantitative Inorganic Analysis including Elementary Instrumental Analysis' (3<sup>rd</sup> Edition) – Arthur I. Vogel: Section I, 60 – Thermogravimetric method of analysis.

### 2 Scope

This Test Method describes the procedure for the determination of the organic content of soil by loss on ignition. It determines the total organic content of a sample (including any undecomposed organic matter such as particles of grass, sticks, and so on) by igniting the sample at 375°C in a furnace and calculating the resultant percentage mass loss.

### 3 Apparatus

The following apparatus is required:

- 3.1 Sieve, 2.36 mm conforming to ISO 3310.
- 3.2 Balance of suitable capacity, with a resolution of at least 0.0001 g and with a limit of performance within the range of  $\pm 0.0005$  g.
- 3.3 Drying ovens:
  - a) Oven of suitable capacity, having a temperature of 45-50°C and conforming to AS 1289.0.
  - b) Oven, of suitable capacity having a temperature of 105-110°C and conforming to AS 1289.0.
- 3.4 Furnace, maintained at  $375 \pm 25^\circ\text{C}$ .
- 3.5 Ceramic, silica or platinum crucibles.
- 3.6 Desiccator, containing silica gel desiccant or equivalent.
- 3.7 Crucible tongs.
- 3.8 Furnace gloves.

### 4 Definitions

For this Test Method, the following definition shall apply:

- 4.1 Constant mass – when successive weighings do not differ by more than 0.0005 g. The mass recorded in the last weighing is the constant mass value.

### 5 Sample preparation

The sample shall be prepared as follows:

- 5.1 Prepare the bulk sample in accordance with Section 4 of Test Method Q101 to produce a representative subsample of appropriate size.
- 5.2 Further prepare the material by screening the subsample on a 2.36 mm sieve in accordance with Test Method Q101, Subsection 5.4 for fine test fractions to produce a test fraction of approximately 50 g. Discard any material retained on the 2.36 mm sieve.



- 5.3 Oven dry the test fraction at 45-50°C and transfer it to an airtight container in preparation for test.
- 5.4 Prior to test, heat the test fraction in a 105-110°C oven for one hour, transfer to a desiccator and allow to cool to room temperature.

## 6 Procedure

The following procedure shall be performed in duplicate:

- 6.1 Prior to commencing this test, pre-heat the furnace time to 375 ± 25°C
- 6.2 Heat the crucible in the furnace for one hour, cool in the desiccator and determine the mass to the nearest 0.0001 g.
- 6.3 Repeat Step 6.2 until constant mass is attained ( $m_c$ ).
- 6.4 Transfer a representative test portion of approximately 5 g of the test fraction into the crucible. Determine the mass of the crucible and test portion to the nearest 0.0001 g ( $m_s$ ).
- 6.5 Place the crucible into the furnace for two hours.
- 6.6 Remove the crucible from the furnace, cool in the desiccator, and determine the mass to the nearest 0.0001 g.
- 6.7 Return the crucible to the furnace for one hour and repeat Step 6.6 (Note 10.1).
- 6.8 Repeat Step 6.7, if necessary, until constant mass is attained ( $m_r$ ).

## 7 Calculations

Calculations shall be as follows:

- 7.1 Calculate the organic content of each test portion as follows:

$$OC = \frac{100(m_s - m_r)}{m_s - m_c}$$

where	$OC$	=	organic content (%)
	$m_c$	=	mass of crucible (g)
	$m_r$	=	mass of crucible and residue (g)
	$m_s$	=	mass of crucible and test portion (g)

- 7.2 Provided that the results for the two test portions do not differ by more than 0.45%, calculate the mean of the results. Where the results differ by more than 0.45%, repeat the test procedure.

## 8 Reporting

The following shall be reported:

- 8.1 The mean result as the organic content of the sample to the nearest 0.05%, and
- 8.2 The number of this Test Method, that is Q120B.

## **9 Precision**

### **9.1 Repeatability**

The mean results for duplicate tests by the same operator are acceptable if the means do not differ by more than 0.32%.

## **10 Notes on method**

- 10.1 Normally one hour is sufficient, but for higher organic contents, longer periods in the furnace may be required to achieve constant mass.

## Test Method Q125D: Capillary rise of stabilised material

### 1 Source

This Test Method was developed in-house using techniques evolved through internal departmental research investigations.

### 2 Scope

This Test Method sets out the procedure for determining the capillary rise (CR) of soils and crushed rock which have been either modified or stabilised with a stabilising agent or are in their natural state.

Prepare test specimens by compacting material passing 19.0 mm to a nominated dry density and nominated moisture content using standard or modified compactive effort. The test is performed under the following conditions, unless otherwise specified:

- standard compaction
- nominated relative moisture content 100% of OMC, and
- nominated relative compaction 100% of MDD.

Specimens tested using this method are not to be used for determining UCS of the material.

### 3 Apparatus

Where appropriate, the working tolerances of apparatus are contained in Table 1. Examples of mould and rammer are contained in AS 1289.5.1.1, Figures 1 and 2.

The following apparatus is required:

- 3.1 Mould assembly (Mould A), comprising a cylindrical metal mould having an internal diameter of 105 mm and an effective height of 115.5 mm, fitted with a detachable baseplate and a removable collar assembly about 60 mm high, both of which can be firmly attached to the mould.
- 3.2 Steel rammer, having a 50 mm diameter face. For standard compactive effort, a rammer with a drop mass of 2700 g and a drop height of 300 mm. For modified compactive effort, a rammer with a drop mass of 4900 g and a drop height of 450 mm.
- 3.3 Balance of suitable capacity, with a resolution of at least 1 g and with a limit of performance within the range of  $\pm 5$  g.
- 3.4 Sieves, 19.0 mm and 9.50 mm conforming to ISO 3310.
- 3.5 Material height gauge. A flat steel bar, about 250 mm long, 25 mm wide and 1-3 mm thick is satisfactory (Note 11.1).
- 3.6 Sample extractor, such as a jack, lever frame or other suitable device for extruding compacted specimens from the mould.
- 3.7 Oven of suitable capacity, having a temperature of 45°C to 50°C and conforming to AS 1289.0.
- 3.8 Steel rule, at least 200 mm long and with a resolution of not exceeding 1 mm.
- 3.9 Water bath of suitable capacity, able to maintain a depth of 10 mm for 72 hours.

## 4 Materials

The following materials are required:

- 4.1 Potable water.

## 5 Sample preparation

- 5.1.1 Prepare the bulk sample in accordance with Section 4 of Test Method Q101 to produce a representative subsample of appropriate size. It may be necessary, to partially dry the bulk sample before preparation so that the material is sufficiently dry to allow uniform mixing of the stabilising agent with the host material.
- 5.1.2 Further prepare the material by screening the subsample on a 19.0 mm sieve in accordance with Test Method Q101, Steps 5.2.1 to 5.2.2. Ensure that any aggregations are broken up to pass a 9.50 mm sieve. Discard any material retained on the 19.0 mm sieve and thoroughly remix the material passing the 19.0 mm sieve.
- 5.1.3 Prepare representative test portions of the sieved material in accordance with Test Method Q101, Steps 5.2.3 to 5.2.5 as follows:
  - a) CR test portion, ensuring the CR test portion is of sufficient quantity to mould one specimen and provide a moisture content sample.
  - b) test portion for hygroscopic moisture content, and
  - c) four or more test portions to determine the OMC and MDD.

## 6 Moulding

The test portion shall be moulded as follows:

- 6.1 Determine the mass of the CR test portion prepared in Step 5.1.3 a) ( $m_1$ ).
- 6.2 Determine the hygroscopic moisture content ( $w_1$ ) using the test portion prepared in Step 5.1.3 b) in accordance with Test Method AS 1289.2.1.1.
- 6.3 Determine the MDD and OMC using the test portions prepared in Step 5.1.3. c) in accordance with Test Method Q142A or Q142B as appropriate, using a Type A mould and the specified stabilising agent content.
- 6.4 Calculate the target moisture content ( $w_t$ ) and target dry density to achieve the nominated relative compaction and nominated relative moisture content in accordance with Test Method Q145A.
- 6.5 For materials with stabilising agents, calculate the dry mass of material, quantity of stabilising agent, quantity of admixture, mass of mixing water and mass of dilution water, then mix and condition the CR test portion in accordance with Test Method Q135A (Notes 11.2 and 11.3).
- 6.6 For materials without stabilising agents, calculate the dry mass of each test portion ( $m_2$ ) and mass of mixing water to be added ( $m_3$ ), then mix and cure each the test portion in accordance with Test Method Q255.
- 6.7 Undertake all necessary calculations, mould preparation and compaction of the test portion in accordance with Test Method Q145A to achieve the nominated relative compaction and nominated relative moisture content. Compacting each specimen in three equal layers for standard compaction or five equal layers for modified compaction. Complete the compaction of all specimens within 65 minutes, timed from the first addition of mixing water to the mixture of host material and stabilising agent (Note 11.4).

## 7 Conditioning

The specimen shall be conditioned as follows:

- 7.1 If using stabilising agents, wrap the compacted specimen in plastic wrapping and condition in accordance with Test Method Q135B.
- 7.2 Remove the plastic wrapping from the compacted specimen and place in the 45-50°C oven and dry to a constant mass.

## 8 Testing

The specimen shall be tested as follows:

- 8.1 Following drying, allow the specimen to cool to room temperature.
- 8.2 Using the rule, determine the initial height of the test specimen ( $H$ ).
- 8.3 Place the specimen in the water bath containing potable water and adjust the water level, if necessary, to ensure that 10 mm of the specimen is immersed. Check the water level in the water bath during the test to ensure that 10 mm of the specimen remains immersed.
- 8.4 Record the time of immersion as 0 hours.
- 8.5 Using the ruler, determine the height from the base of the specimen to the maximum level of CR ( $h_i$ ) at 0.25, 0.5, 1.0, 1.5, 2.0, 4.0, 8.0, 24, 48 and 72 hours. If the maximum level of CR reaches the top of the specimen before 72 hours record the time and terminate the test.

## 9 Calculations

Calculations shall be as follows:

- 9.1 Using the achieved moisture content, calculate the achieved dry density, achieved relative compaction and the achieved relative moisture content of the specimen in accordance with Test Method Q145A.
- 9.2 Compare the achieved dry density and target dry density. If they differ by more than 0.02 t/m<sup>3</sup>, discard the specimen, and repeat the preparation to Q145A for the nominated conditions.
- 9.3 Compare the achieved moisture content and the target moisture content. If they differ by more than 1.0%, discard the specimen, and repeat the preparation to Q145A for the nominated conditions.
- 9.4 Calculate the CR as follows:

$$CR = \frac{h - 10}{H - 10} 100$$

where  $CR$  = capillary rise (%)  
 $h$  = maximum level of CR at the termination of the test or 72 hours (mm)  
 $H$  = initial height of the specimen (mm)

- 9.5 Using the set of CR readings, plot the CR ( $h_i$ ) (mm) against time in hours. From the plot, determine the time taken for the CR to reach the top of the specimen as the rise time in hours.

## 10 Reporting

The following shall be reported:

### 10.1 Moisture / density relationship results:

- a) MDD to the nearest 0.01 t/m<sup>3</sup>
- b) OMC to the nearest 0.5%

### 10.2 Compaction results:

- a) The following in accordance with Test Method Q145A:
  - i. nominated relative compaction and nominated relative moisture content
  - ii. target dry density and target moisture content
  - iii. achieved dry density and achieved moisture content, and
  - iv. achieved relative compaction and achieved relative moisture content.
- b) Compaction standard used, that is standard or modified.

### 10.3 Capillary rise:

- a) Initial height of the specimen to the nearest 1 mm.
- b) The rise time to the nearest 0.5 hours, and
- c) Capillary rise to the nearest 1%.

### 10.4 The number of this Test Method, that is Q125D.

## 11 Notes on method

11.1 A material height gauge, which allows monitoring of the height of compacted material relative to the top of a Mould A, can be made from a steel bar and marked as follows:

11.1.1 Mould A (standard compaction): Commencing at one end of the bar, measure and mark distances of:

- a) 5.5 mm for the upper range of the third layer
- b) 33.5 mm and 38.5 mm for the acceptable range of the second layer, and
- c) 72.5 mm and 77.5 mm for the acceptable range of the first layer.

11.1.2 Mould A (modified compaction): Commencing at one end of the bar, measure and mark distances of:

- a) 5.5 mm for the upper range of the fifth layer
- b) 17.5 mm and 22.5 mm for the acceptable range of the fourth layer
- c) 40.5 mm and 45.5 mm for the acceptable range of the third layer
- d) 63.5 mm and 88.5 mm for the acceptable range of the second layer, and
- e) 87.5 mm and 92.5 mm for the acceptable range of the first layer.

11.1.3 Mark the face with the appropriate mould size (A).

- 11.2 When mixing and conditioning more than one test portion, sequence the work to conform to any time for conditioning and the time to completion of compaction. Measure both of these times from the addition of the first increment of water to the mixture of soil and stabilising agent.
- 11.3 Compact test portions that do not contain stabilising agents at the completion of mixing the soil and mixing water.
- 11.4 It may be advantageous to perform simultaneous compaction of the specimens where compaction is performed by compacting the same layer in each mould one after the other

**Table 1 – Dimensions and tolerances of compaction apparatus**

Apparatus	Dimension	Tolerance
<b>Mould A</b>		
Internal diameter (mm)	105.0	± 0.5*
Height (mm)	115.5	± 0.5*
Nominal volume (cm <sup>3</sup> )	1000	± 15
<b>Rammer</b>		
Diameter; round foot (mm)	50	± 0.4
Area of rammer (mm <sup>2</sup> )	1964	± 31
<b>Standard compaction (Mould A)</b>		
Drop (mm)	300	± 2.0
Mass (kg)	2.7	± 0.01
<b>Modified compaction (Mould A)</b>		
Drop (mm)	450	± 2.0
Mass (kg)	4.9	± 0.01

\* Either but not both of the tolerances may be exceeded provided that the specified tolerance on volume is not exceeded.

## Test Method Q133: Lime demand of soil

### 1 Source

This Test Method was developed in-house and is based on the procedure described in Eades JL Grim RE (1966) 'A Quick Test to Determine Lime Requirements for Soil Stabilisation,' *Highway Research Record No. 139*: 61-72, National Academy of Sciences, National Research Council, Highway Research Board, Washington DC. This Test Method has been further modified based on Test Method ASTM D6276: *Standard test method for using pH to estimate the soil-lime proportion requirement for soil stabilisation* as follows:

- a) to include the use of a water bath to maintain the temperature of buffer solutions, distilled water and suspensions at  $25.0 \pm 1.0^\circ\text{C}$
- b) the definition of the lime demand has been aligned with ASTM Test Method
- c) the requirement for the pH to exceed 12.3 for a valid result to be determined
- d) report the available lime index of the lime used in testing, and
- e) include a plot of the mean pH against hydrated lime content in the report.

### 2 Scope

This Test Method describes the procedure to determine the degree to which a soil will react with calcium hydroxide through cationic exchange and pozzolanic responses from reactive clay minerals. The method provides for the determination of the lime demand (percent lime), as measured using an extended pH test. The lime demand is a minimum lime content in determining the design lime content. The lime demand test provides lime contents that correspond well with minimum lime contents required for effective long-term stabilisation.

### 3 Apparatus

The following apparatus is required:

- 3.1 pH meter, equipped with combination type, high alkaline pH electrode (Notes 8.1 and 8.2).
- 3.2 Balance of suitable capacity, with a resolution of 0.01 g and with a limit of performance within the range  $\pm 0.05$  g.
- 3.3 Sieve, 2.36 mm conforming to ISO 3310.
- 3.4 Beakers, 100 mL.
- 3.5 Watchglasses, of appropriate size to cover the 100 mL beakers.
- 3.6 Water bath, maintained at a temperature of  $25.0 \pm 1.0^\circ\text{C}$ .
- 3.7 Measuring cylinder, a glass measuring cylinder of 100 mL capacity.
- 3.8 Magnetic stirrer.
- 3.9 Magnetic stirrer bars.
- 3.10 Wash bottle.
- 3.11 Bottles, for storing extra distilled water in water bath.
- 3.12 Glass stirring rod.



## 4 Materials

The following materials are required:

- 4.1 Neutral and high pH buffer solutions as recommended by the manufacturer of the pH meter, for example, pH of 7 and pH of 10 to 12 (Notes 8.3 and 8.4).
- 4.2 Hydrated lime (Notes 8.5 and 8.6):
  - a) conforming to AS 1672.1: *Limes and Limestones; Part 1 – Limes for building*
  - b) not more than three months old, measured from date of manufacture, and
  - c) with an available lime index not less than 80%.

## 5 Procedure

The procedure shall be as follows:

### 5.1 Sample preparation

- 5.1.1 Prepare the bulk sample in accordance with Section 4 of Test Method Q101 to produce a representative subsample of appropriate size.
- 5.1.2 Further prepare the material by screening the subsample on a 2.36 mm sieve in accordance with Test Method Q101, Subsection 5.4 for fine test fractions to produce a test fraction of approximately 600 g. Discard any material retained on the 2.36 mm sieve.
- 5.1.3 Prepare representative test portions as follows:
  - a) One test portion for hygroscopic moisture content, and
  - b) One test portion of about 500 g for pH testing and place in an airtight container.
- 5.1.4 Determine the hygroscopic moisture content ( $w_1$ ) of the test portion prepared in Step 5.1.3 a) in accordance with Test Method AS 1289.2.1.1.

### 5.2 Calculation of test masses

For each lime increment calculate the mass of soil and mass of hydrated lime to be used, based on a combined dry mass of 30 g as follows (Note 8.7):

#### 5.2.1 Mass of Soil Test Portion

$$m_w = \left( \frac{30}{1 + \frac{p}{100}} \right) \left( 1 + \frac{w_1}{100} \right)$$

- where
- $m_w$  = mass of soil (g)
  - $w_1$  = hygroscopic moisture content (%)
  - $p$  = lime content (%)

#### 5.2.2 Mass of hydrated lime

$$m_1 = 30 - \left( \frac{30}{1 + \frac{p}{100}} \right)$$

- where
- $m_1$  = mass of lime (g)
  - $p$  = lime content (%)

### **5.3 Calibration of pH meter**

- 5.3.1 Wash the electrode with distilled water and calibrate the pH meter by means of the standard buffer solutions at  $25.0 \pm 1.0^\circ\text{C}$ , following the procedure recommended by the manufacturer (Notes 8.3 and 8.4).
- 5.3.2 Wash the electrode with distilled water and leave it in a beaker of distilled water at  $25.0 \pm 1.0^\circ\text{C}$  when not in use (Note 8.4).

### **5.4 pH determination of hydrated lime only**

- 5.4.1 Add 5 g of hydrated lime to a beaker. Then cover each beaker with a watchglass.
- 5.4.2 Add 75 mL of distilled water at  $25.0 \pm 1.0^\circ\text{C}$  to the beaker (Note 8.4).
- 5.4.3 Mix the hydrated lime / distilled water suspension using the magnetic stirrer for about 30 seconds. Cover the beaker with a watch glass, place the beaker in the water bath and allow it to stand for 2 hours.
- 5.4.4 Remove the beaker from the water bath and restart the stirrer and lower the pH electrode into the suspension until the bulb is just covered.
- 5.4.5 Read the pH meter at 1 minute intervals and continue readings until three successive values are within a range of 0.05 pH units. Record these values to the nearest 0.01 units together with the mean pH value of the hydrated lime (Note 8.8).
- 5.4.6 Remove the electrode from the beaker, wash it with distilled water and check the reading of the meter in accordance with Subsection 5.3 using the higher pH buffer solution. If the reading varies by more than 0.05 pH units from that determined during calibration, repeat Steps 5.4.1 to 5.4.6.

### **5.5 pH determination of soil-lime mixtures**

- 5.5.1 Prepare the required number of test portions with individual masses as calculated in Step 5.2.1, in accordance with Test Method Q101B, Subsection 4.2 and place the test portions in suitably marked beakers.
- 5.5.2 Add the corresponding mass of hydrated lime as calculated in Step 5.2.2 to each beaker and thoroughly mix the constituents using a glass stirring rod, then cover each beaker with a watchglass.
- 5.5.3 Add 75 mL of distilled water at  $25.0 \pm 1.0^\circ\text{C}$  to the beaker (Note 8.4). The addition should be staggered to allow sufficient time for readings in Step 5.5.6 to be undertaken two hours after the addition of distilled water.
- 5.5.4 Mix the suspension using the magnetic stirrer for about 30 seconds. Cover the beaker with a watch glass, place the beaker in the water bath and allow it to stand for two hours.
- 5.5.5 Remove the beaker from the water bath and restart the stirrer and lower the pH electrode into the suspension until the bulb is just covered.
- 5.5.6 Read the pH meter at one-minute intervals and continue readings until three successive values are within a range of 0.05 pH units. Record these values to the nearest 0.01 units, together with the mean pH value (Note 8.8).
- 5.5.7 Remove the electrode from the beaker, wash it with distilled water and check the reading of the meter in accordance with Subsection 5.3 using the higher pH buffer solution. If the reading varies by more than 0.05 pH units from that determined during calibration, repeat Steps 5.3.1 to 5.3.2 and Steps 5.5.1 to 5.5.6.

- 5.5.8 Continue testing each of the soil-lime mixtures in order, commencing with the lowest lime content, by repeating Steps 5.5.5 to 5.5.7
- 5.5.9 Continue testing until the mean pH values of the three highest lime contents do not vary by more than 0.05 pH units. If the test portions prepared do not achieve this requirement, calculate the mass of constituents for a further number of higher lime contents and undertake additional testing in accordance with Subsections 5.2 and 5.5.
- 5.5.10 If the highest measured pH is less than 12.3, prepare and test additional test portions using higher percentages of lime.
- 5.5.11 If the highest measured pH remains less than 12.3, the test is invalid. This may be due to equipment or material issues (Note 8.9) or insufficient lime added. Check pH electrode in the pH 12 buffer solution and the lime distilled water solution.

## 6 Calculations

Calculations shall be as follows:

- 6.1 Plot the mean pH against its hydrated lime content and join each point. Next, draw a line parallel to the X-axis corresponding to the pH for hydrated lime (12.4).
- 6.2 Record the lowest hydrated lime content (HLC) where:
  - a) the pH peaks at 12.4 or exceeds 12.4, or
  - b) where the pH reaches a stable peak value between 12.3 and 12.4 inclusive: that is, a plateau where the pH values do not vary by more than 0.05 pH units over three successive soil-lime mixtures (Figure 1 and Note 8.9).

## 7 Reporting

The following shall be reported:

- 7.1 Hydrated lime content (HLC) as the lime demand for the soil to the nearest 0.5%.
- 7.2 Source of hydrated lime.
- 7.3 pH of the hydrated lime / distilled water suspension to the nearest 0.1 pH units.
- 7.4 The plot of mean pH against hydrated lime content, together with the hydrated lime pH (12.4).
- 7.5 The number of this Test Method, that is Q133.

## 8 Notes on method

- 8.1 An electrode manufactured using a medium lithium glass is satisfactory for measuring pH up to 12.4 as required by this Test Method.
- 8.2 Examples of the care and maintenance of pH electrodes may be found in publications such as Horiba Instruments (n.d.), *pH Electrode Care and Maintenance Procedures Technical Tip 04*.
- 8.3 The shelf life of Ph of 7 buffer solution is usually 12 months, while that of pH of 10 to 12 buffer solution is about 6 months. Refrigerate buffer solutions after use and exercise care to ensure no contamination of the solutions through reuse or carbonation by exposure to air occurs.
- 8.4 Store wash bottle, bottles of extra distilled water, pH electrode in distilled and buffer solutions in the water bath to minimise equilibration time during testing.

- 8.5 If the available lime index is required to be supplied with the test report, for example, Technical Specification MRTS07A *In situ Stabilised Subgrades using Quicklime or Hydrated Lime* Clause 6.2. Determine the available lime index in accordance with Test Method AS 4489.6.1: *Test methods for limes and limestones – Lime index – Available lime* and provide the test report or provide a test certificate from the lime supplier that includes the result for available lime index.
- 8.6 Before handling hydrated lime, the operator should consult the relevant SDS.
- 8.7 Add lime at 1 percent increments commencing at a lime content of 1 percent. The number of lime increments used in any test is dependent on the reactivity of soil under consideration. Six increments are appropriate for a medium plasticity soil, while up to 10 increments may be necessary for a highly plastic soil.
- 8.8 The pH readings of the soil-lime suspension should reach a constant value in 2 to 3 minutes.
- 8.9 The stable pH value of the soil-lime mixture should be the same as the pH of the hydrated lime mixture. The presence of cations such as sodium in the soil pore water may reduce the solubility of the hydrated lime, thus reducing the pH of the solution. Occasionally the soil-lime mixture may plateau at values of 12.2 or even slightly lower, which is below the pH value of 12.4 for hydrated lime under standard conditions.

**Figure 1 – pH / hydrated lime content**

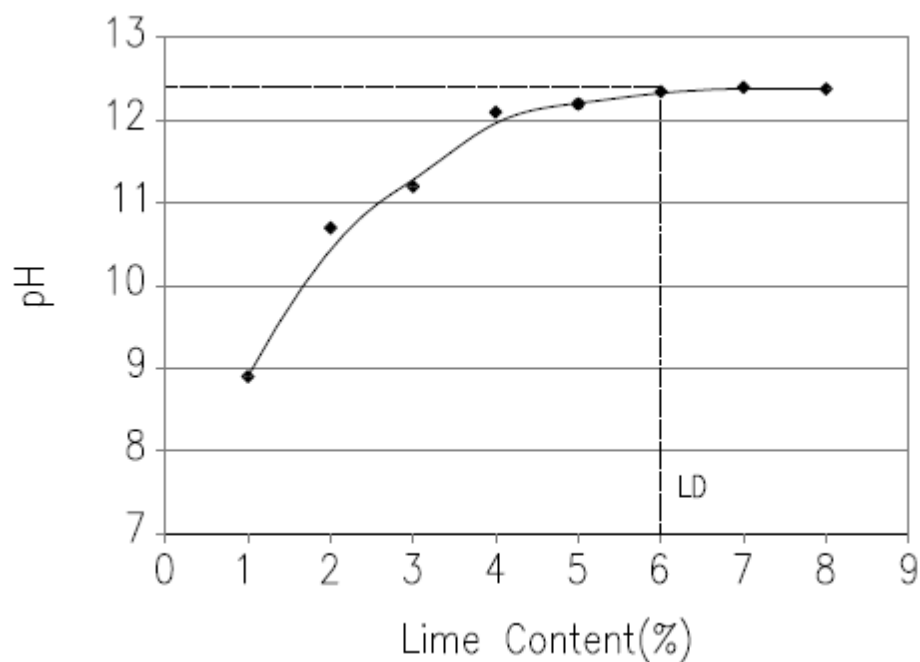

## Test Method Q134: Stabilising agent content - heat of neutralisation

### 1 Source

This Test Method was developed in-house and is based on the procedure described in Taskis HD (1964) *Estimation of Cement Content of Stabilised Crushed Rock; A Method of Eliminating Errors due to Aggregate Reaction*, ARRB Conference, Volume 2. This Test Method was further modified using the recommendations from Vanderstaay AGB (1986) *Further investigations into the heat of neutralisation test (Q116B) for determining cement content of CTB*, Central Division, Department of Main Roads, and Vanderstaay AGB (1986) *An analysis of the heat of neutralisation test*, Queensland Roads, 23(1) 33-38.

### 2 Scope

This Test Method describes the procedure to determine the stabilising agent content of fresh mixtures of soil or crushed rock that have been modified or stabilised with a general purpose or blended cements. This Test Method is also suitable to materials stabilised with hydrated lime or blends of hydrated lime and supplementary cementitious materials. The Test Method relies on the exothermic reaction of free alkalis in the stabilising agent with a buffered acetic acid solution and is limited to stabilising agent types and concentrations that produce an effective temperature rise of at least 4°C. Results are reliable, when the testing procedure is completed within four hours of the mixing of the soil or crushed rock with the stabilising agent.

The Test Method is generally not suitable for materials that contain significant quantities of carbonate compounds since the carbonate reacts with the buffer solution to produce carbon dioxide and heat.

### 3 Apparatus

The following apparatus is required:

- 3.1 Thermometer, a partial immersion thermometer or other suitable temperature measuring device with a temperature range of at least 0-60°C and graduated to 0.1°C or less with an uncertainty of no more than 0.5°C.
- 3.2 Balance of suitable capacity, with a resolution and limit of performance as specified in Table 1.
- 3.3 Measuring cylinders, of 500 mL, 1000 mL and 2000 mL capacity with graduations not greater than 5 mL, 10 mL and 20 mL respectively.
- 3.4 Mixing containers, having a capacity approximately 30% larger than the combined volume of solids and liquids used in the test.
- 3.5 Timer, such as stopwatch.
- 3.6 Mechanical mixer, a motorised or a hand operated tumbler mixer that rotates at a constant rate and provides complete mixing of the constituents. A suitable mixer speed is 20 rpm.
- 3.7 Cloth, container and potable water for cleaning thermometer after each measurement.

The following apparatus may be used:

- 3.8 Heavy duty plastic bags (polyethylene), capable of containing constituents during mixing and sealing specimens against moisture loss. The volume of the bag should be slightly larger than the mixing container when sealed.
- 3.9 Cable ties, elastic bands or other suitable means for sealing the plastic bags.

## 4 Reagents

All reagents are TG (technical grade) and the following are required:

### 4.1 Buffer solution:

- Prepare by dissolving 250 g of sodium acetate, 240 g of glacial acetic acid in about 500 mL of potable water (Notes 9.1 and 9.2). Make up to one litre using additional potable water.

## 5 Calibration

Perform the calibration for each combination of stabilising agent, admixture and soil or crushed rock to be stabilised as follows:

### 5.1 Sample preparation

- 5.1.1 Prepare the bulk sample in accordance with Section 4 of Test Method Q101 to produce a representative subsample of appropriate size. It may be necessary to dry the bulk sample before preparation so that the material is sufficiently dry to allow uniform mixing of the stabilising agent with the host material.
- 5.1.2 Further prepare the material by screening the subsample on a 37.5 mm sieve in accordance with Test Method Q101, Steps 5.2.4 to 5.2.6. Ensure that any aggregations are broken up to pass a 9.50 mm sieve. Discard any material retained on the 37.5 mm sieve and thoroughly remix the material passing the 37.5 mm sieve.
- 5.1.3 Prepare representative test portions of the sieved material in accordance with Test Method Q101, Steps 5.2.4 to 5.2.6 which are of sufficient size to yield the soil masses determined in Subsection 5.2 as follows:
- a) at least 12 test portions of sufficient quantity for the calibration testing. Refer to Table 1 for minimum test portion masses
  - b) test portion for hygroscopic moisture content, and
  - c) suitable number and mass of test portions to determine the OMC and MDD.
- 5.1.4 Determine the hygroscopic moisture content (w) using the test portion prepared in Step 5.1.3 b) in accordance with Test Method AS 1289.2.1.1.
- 5.1.5 Determine the MDD and OMC using the test portions prepared in Step 5.1.3. c) in accordance with Test Method Q142A or Q142B as appropriate, with the specified stabilising agent content. If all material passes the 19.0 mm test sieve in Step 5.1.2, use a Type A mould; otherwise, use the Type B mould.
- 5.1.6 Bring the remaining test portions, apparatus and buffer solution to the temperature of the test environment at least 2 hours before testing is to commence (Notes 9.3 and 9.4).

### 5.2 Test portion calculations

- 5.2.1 Calculate the mass of wet material, mass of water and mass of stabilising agent over the range  $\pm 1.0\%$  of target content of stabilising agent in increments of 0.5% with the minimum content not being less than 0.5%. Where the target content of stabilising agent is less than 1.5%, only four contents are to be calculated.

5.2.2 Calculate the mass of wet material for each stabilising agent content as follows:

$$m_d = \frac{M}{1 + \frac{A}{100} + \frac{w_o}{100} \left(1 + \frac{A}{100}\right)}$$

where  $m_d$  = mass of dry material (g)  
 $M$  = mass of test portion (material, water and stabilising agent) to be used in the calibration from Table 1 (g)  
 $A$  = stabilising agent content (%)  
 $w_o$  = optimum moisture content (%)

$$m_w = m_d \left(1 + \frac{w}{100}\right)$$

where  $m_w$  = mass of wet material (g)  
 $m_d$  = mass of dry material (g)  
 $w$  = hygroscopic moisture content (%)

5.2.3 Calculate the mass of stabilising agent for each stabilising agent content as follows:

$$m_a = \frac{m_d A}{100}$$

where  $m_a$  = mass of stabilising agent (g)  
 $m_d$  = mass of dry material (g)  
 $A$  = stabilising agent content (%)

5.2.4 Calculate the mass of water for each stabilising agent content as follows:

$$m = (m_d + m_a) \frac{w_o}{100} - (m_w - m_d)$$

where  $m$  = mass of water (g)  
 $m_d$  = mass of dry material (g)  
 $m_a$  = mass of stabilising agent (g)  
 $w_o$  = optimum moisture content (%)  
 $m_w$  = mass of wet material (g)

### 5.3 Minimum test portion size

Optimise the minimum test portion size for the lowest stabilising agent content (target content of stabilising agent minus 1%) as follows:

- 5.3.1 Using one of the test portions, obtain a test portion having a wet material mass as calculated in Step 5.2.2 for the lowest stabilising agent content. For low stabilising agent contents in the range of 1 to 2% a test portion size of 3000 or 4000 g will be suitable.
- 5.3.2 Weigh the required mass of stabilising agent and thoroughly mix it with the test portion.
- 5.3.3 Weigh the required mass of water. Then mix it with the material and stabilising agent for two minutes using the mechanical mixer or by hand.
- 5.3.4 Measure out a volume of buffer solution ( $V_c$ ) that, when mixed in the mechanical mixer with the material, stabilising agent and water mixture, will achieve a temperature rise of at least 4°C at the completion of four minutes mixing (Note 9.5).

- 5.3.5 If the mixture fails to achieve the temperature rise, repeat Steps 5.3.1 to 5.3.4, adjusting the volume of buffer solution to obtain a suitable temperature rise.

#### **5.4 Buffer solution content**

Optimise the buffer solution content for the highest stabilising agent content (target content of stabilising agent plus 1%) as follows:

- 5.4.1 Using one of the test portions, obtain a test portion having a wet material mass as calculated in Step 5.2.2 for the highest stabilising agent content.
- 5.4.2 Weigh the required mass of stabilising agent and thoroughly mix it with the test portion.
- 5.4.3 Weigh the required mass of water. Then mix it with the material and stabilising agent for two minutes using the mechanical mixer or by hand.
- 5.4.4 Measure out a volume of buffer solution ( $V_c$ ) that, when mixed in the mechanical mixer with the material, stabilising agent and water mixture, will have a thick consistency at the completion of four minutes mixing (Note 9.5).
- 5.4.5 If the mixture either forms a gel or is fluid-like, repeat Steps 5.4.1 to 5.4.4, adjusting the volume of buffer solution to obtain a thick consistency.

#### **5.5 Procedure**

For each of the stabilising agent contents, undertake the following:

- 5.5.1 Using one of the test portions, obtain a test portion of appropriate mass and place it in the mixing container or mixing tray.
- 5.5.2 Weigh the required mass of stabilising agent and thoroughly mix it with the test portion.
- 5.5.3 Weigh the required mass of water and mix it with the material and stabilising agent for exactly two minutes using the mechanical mixer or by hand.
- 5.5.4 At the completion of mixing, insert the thermometer in the mixture and record the temperature ( $T_{c1}$ ) after 60 seconds.
- 5.5.5 Measure out the required volume of buffer solution ( $V_c$ ) and insert the thermometer in the solution and record the temperature ( $T_{c2}$ ) after 60 seconds.
- 5.5.6 Add the buffer solution to the material, stabilising agent and water mixture, then immediately mix in the mechanical mixer for exactly four minutes, timed from the start of mixing.
- 5.5.7 At the completion of mixing, insert the thermometer into the mixture and record the temperature ( $T_{c2}$ ) after 60 seconds.
- 5.5.8 Repeat Steps 5.5.1 to 5.5.7 with the same stabilising agent content.
- 5.5.9 Repeat Steps 5.5.1 to 5.5.8 for each remaining stabilising agent contents.

### **6 Test procedure**

The procedure shall be as follows:

- 6.1 Prior to the commencement of each test. Ensure all apparatus and including the mixing container and buffer solution has equilibrated to temperature of the test environment (Note 9.3).
- 6.2 Obtain a representative sample of the mixed material as soon as possible after the completion of mixing.



- 6.3 Prepare a test portion of the sample by splitting in accordance with Test Method Q101B to produce a test portion within 0.5% of the mean mass used in the calibration.
- 6.4 Place the test portion in the mixing container, insert the thermometer and record the temperature ( $T_1$ ) after 60 seconds.
- 6.5 Measure out the same volume of buffer solution ( $V_c$ ) as used in the calibration and insert the thermometer in the solution and record the temperature ( $T_2$ ) after 60 seconds.
- 6.6 If the temperature difference between the sample and the buffer solution exceeds 3°C, heat or cool the test portion as appropriate and repeat Steps 6.3 to 6.4 before continuing (Notes 9.4 and 9.6).
- 6.7 Add the buffer solution to the test portion, then immediately mix in the mechanical mixer for exactly four minutes timed from the start of mixing.
- 6.8 At the completion of mixing, insert the thermometer in the mixture and record the temperature ( $T_3$ ) after 60 seconds.

## 7 Calculations

Calculations shall be as follows:

### 7.1 Calibration

- 7.1.1 Calculate the temperature rise for each test portion as follows:

$$\Delta T_c = T_{c3} - \left( \frac{0.0003MT_{c1} + 1.2V_cT_{c2}}{0.0003M + 1.2V_c} \right)$$

- where
- $\Delta T_c$  = temperature rise (°C)
  - $T_{c3}$  = temperature of the material, stabilising agent, water and buffer solution mixture (°C)
  - $M$  = mass of test portion (material, stabilising agent and water) (g)
  - $T_{c1}$  = temperature of the material, stabilising agent and water (°C)
  - $V_c$  = volume of buffer solution (L)
  - $T_{c2}$  = temperature of the buffer solution (°C)

7.1.2 Determine the relationship between the stabilising agent content and temperature rise using linear regression analysis of the following relationship:

$$y = bx + a$$

where  $y$  = stabilising agent content (A) (%)  
 $b$  = slope of linear relationship  
 $x$  = temperature rise ( $\Delta T_c$ ) ( $^{\circ}\text{C}$ )  
 $a$  = Y intercept of linear relationship

a) Determine the slope of the linear relationship as follows:

$$b = \frac{n \sum xy - \sum x \sum y}{n \sum x^2 - (\sum x)^2}$$

where  $b$  = slope of linear relationship  
 $\sum x$  = sum of the temperature rise measurements ( $\Delta T_c$ )  
 $\sum y$  = sum of the stabilising agent contents  
 $\sum x^2$  = sum of the squares of the temperature rise measurements ( $\Delta T_c$ )  
 $\sum xx$  = sum of the products of the corresponding results from the temperature rise measurements ( $\Delta T_c$ ) and the stabilising agent contents  
 $n$  = number of pairs of test measurements

b) Determine the y intercept of the linear relationship as follows:

$$a = \frac{1}{n} \left( \sum y - b \sum x \right)$$

where  $a$  = y intercept of linear relationship  
 $n$  = number of pairs of test measurements  
 $\sum y$  = sum of the stabilising agent contents  
 $b$  = slope of linear relationship  
 $\sum x$  = sum of the temperature rise measurements ( $\Delta T_c$ )

c) Repeat any point that is at variance with the trend of the calibration and re-analyse the test data.

7.1.3 Determine the calibration constant ( $c$ ) as follows:

$$c = \left( \frac{0.0003Mb}{0.0003M + 1.2V_c} \right)$$

where  $c$  = calibration constant  
 $M$  = mass of test portion (material, stabilising agent and water) (g)  
 $b$  = slope of linear relationship  
 $V_c$  = volume of buffer solution (L)

7.1.4 Determine the calibration constant ( $d$ ) as follows:

$$d = \left( \frac{1.2V_c b}{0.0003M + 1.2V_c} \right)$$

where	$d$	=	calibration constant
	$V_c$	=	volume of buffer solution (L)
	$b$	=	slope of linear relationship
	$M$	=	mass of test portion (material, stabilising agent and water) (g)

## 7.2 Test

7.2.1 Calculate the stabilising agent content using the calibration constants for the combination of stabilising agent, admixture and soil or crushed rock tested as follows:

$$A = bT_3 - cT_1 - dT_2 + a$$

where	$A$	=	stabilising agent content (%)
	$b$	=	slope of linear relationship
	$T_3$	=	temperature of the material, stabilising agent, water and buffer solution mixture (°C)
	$c$	=	calibration constant
	$T_1$	=	temperature of the test portion (material, stabilising agent and water) (°C)
	$d$	=	calibration constant
	$T_2$	=	temperature of the buffer solution (°C)
	$a$	=	y intercept of linear relationship

## 8 Reporting

The following shall be reported:

### 8.1 Calibration

8.1.1 The relationship between the stabilising agent content ( $y$ ) and temperature rise ( $x$ ) in the form:  $A = bT_3 - cT_1 - dT_2 + a$ . Report the values of  $b$ ,  $c$  and  $d$  to the nearest 0.0001 and  $a$  to the nearest 0.001.

8.1.2 The range of stabilising agent contents used in the calibration to the nearest 0.1%.

8.1.3 The volume of buffer solution used to the nearest 10 mL.

8.1.4 Mass of test portion used to the nearest 10 g.

8.1.5 General information:

- source and description of the soil or crushed rock.
- source, ATIC Registration number and type of stabilising agent (Note 9.7).

8.1.6 The number of this Test Method, that is Q134.

### 8.2 Test Result

8.2.1 The stabilising agent content to the nearest 0.05%, and

8.2.2 The number of this Test Method, that is Q134.

## 9 Notes on method

- 9.1 Before handling sodium acetate or acetic acid, the operator should consult the relevant SDS.
- 9.2 The shelf life of the buffer solution is 90 days when stored at  $23^{\circ}\text{C} \pm 3^{\circ}\text{C}$  (air-conditioned environment), otherwise 7 days.
- 9.3 The test environment is an area that is isolated from drafts and heat sources, that is, a relatively uniform temperature. The calibration and the testing should be performed in the same environment.
- 9.4 Normally test portions and equipment will reach the temperature of the test environment within 30 minutes. The temperature difference between the test portion and the buffer solution should not exceed  $3^{\circ}\text{C}$ .
- 9.5 The ratio of buffer solution to test portion can vary from 1 litre per 1000 g for a reactive stabilising agent to 1 litre per 5000 g for an unreactive stabilising agent. For a stabilising agent composition, the volume of buffer solution increases with increasing target content of stabilising agent.
- 9.6 The following techniques for warming or cooling a test portion such as:
- spreading it thinly on a tray and covering the material with a damp cloth
  - spreading it thinly on a tray, covering with a dry cloth and directing warm air over the material, or
  - placing the material in a plastic bag and immersing in a water bath,
- have been found to be suitable.
- 9.7 The supplier of the cementitious materials can supply this information. Further details are available from the ATIC, *Cementitious Materials Registration Scheme (CMRS), Registered Products List*.

**Table 1 – Test portion and general balance requirements**

Material type	Test portion minimum mass (g)	Balance resolution (g)	Limit of performance of balance (g)
Medium-grained material with 0-20% retained on 19.0 mm sieve	1000	0.1	$\pm 0.5$
Coarse-grained material with 0-20% retained on 37.5 mm sieve	5000	1	$\pm 5$
Stabilising agent for calibration	-	0.1	$\pm 0.5$
Water for calibration	-	0.1	$\pm 0.5$

## Test Method Q135A: Addition of stabilising agents

### 1 Source

This Test Method was developed in-house using techniques evolved through internal departmental research investigations.

### 2 Scope

This Test Method describes the procedure for calculating the quantity of stabilising agent(s) and any specified admixture(s) to add to a host soil or crushed rock as well as the procedures for mixing, by either hand or machine, the constituent materials, and the conditioning of the mixture prior to compaction. The mixing process allows for the incorporation of one or more stabilising agents and provides the techniques for the addition of hydraulic, bituminous, or ionic agents.

### 3 Apparatus

Where appropriate, the working tolerances of apparatus are contained in Table 1. Examples of moulds and rammer are contained in AS 1289.5.1.1, Figures 1 and 2.

The following apparatus is required:

#### 3.1 Mixing apparatus

- 3.1.1 For hand mixing, miscellaneous mixing apparatus, such as a tray, trowel or scoop and water spray suitable for mixing stabilising agent and water increments into the material.
- 3.1.2 For machine mixing, mechanical mixing equipment, for example, pugmill or catering style dough mixer capable of mixing stabilised portions.
- 3.1.3 Suitable tools for removing all materials from mixer such as a mallet, spatula and scoop.
- 3.1.4 Sealable containers, suitable for curing mixed test portions.

#### 3.2 Amelioration apparatus

For amelioration, the following additional apparatus is required:

- 3.2.1 Air curing environment in accordance with Test Method Q135B.
- 3.2.2 Metal moulds, of a size dependent on the maximum size of material being tested, as follows:
- 3.2.3 For compaction of material passing a 19.0 mm sieve:

Mould A: A cylindrical metal mould having an internal diameter of 105 mm and effective height of 115.5 mm, fitted with a detachable baseplate and a removable collar assembly about 60 mm high both of which can be firmly attached to the mould.

- 3.2.4 For compaction of material which has rock material retained on the 19.0 mm sieve:

Mould B: A cylindrical metal mould having an internal diameter of 152 mm and an effective height of 132.5 mm, fitted with a detachable baseplate and a removable collar assembly about 60 mm high both of which can be firmly attached to the mould.

- 3.2.5 Rammer, a metal rammer having a 50 mm diameter face, a drop mass of 2700 g and a drop height of 300 mm. A mechanical compactor may be used provided the essential dimensions are adhered to and the rammer has a free vertical fall of the correct height with blows being uniformly distributed and in keeping with any prescribed cycle of blows. The design of the compactor allows attachment of the mould to a level and rigid support base. The difference between MDD determinations using manual or mechanical compaction is less than 2%.
- 3.2.6 Level rigid foundation on which to compact the specimen, for example a sound concrete floor about 100 mm or more in thickness or a concrete block of at least 100 kg mass.
- 3.3 Balances:
- Balance of suitable capacity, with a resolution of at least 0.1 g and with a limit of performance within the range of 0.5 g (Note 9.1), and
  - Balance of suitable capacity, with a resolution of at least 0.01 g and with a limit of performance within the range of 0.05 g (Note 9.1).
- 3.4 Measuring cylinders of 5 mL, 10 mL or 50 mL capacity as required.

## 4 Materials

The following materials are required:

### 4.1 General requirements:

Stabilising agents used in laboratory testing shall be fresh samples, from manufacturer, of the same type, manufacturer and supplier as expected for the field application. Do not use bagged supplies.

### 4.2 Cements:

May be GP cement or GB cement conforming to AS 3972. Obtain the ATIC Registration number for all cementitious materials (Notes 9.2 and 9.3).

### 4.3 Cementitious blend:

- GP cement (refer to Clause 4.2)
- Fly ash (refer to Clause 4.6)
- Slag (refer to Clause 4.7), and/or
- Hydrated lime (refer to Clause 4.5)

This may be blended in the laboratory or obtained blended from the manufacturer.

### 4.4 Lime / fly ash blend:

- Hydrated lime (refer to Clause 4.5), and
- Fly ash (refer to Clause 4.6)

This may be blended in the laboratory or obtained blended from the manufacturer.

### 4.5 Hydrated lime (Notes 9.3 and 9.4):

- conforming to AS 1672.1: *Limes and Limestones; Part 1 – Limes for building*
- not more than three months old, measured from date of manufacture, and
- with an available lime index not less than 80%.

Due to safety issues and the need to control compaction do not use quicklime for laboratory testing.

4.6 Fly ash):

Special Grade or Grade 1 fly ash conforming to AS/NZS 3582.1 (Note 9.3).

4.7 Slag:

Ground granulated blast furnace slag (GGBFS) conforming to AS 3582.2 (Note 9.3).

4.8 Admixtures (Note 9.3).

4.9 Potable water for mixing.

**5 Calculation of addition rates**

The addition rates shall be calculated as follows:

5.1 Calculate the dry mass of each test portion as follows:

$$m_2 = \frac{100m_1}{100 + w_1}$$

where  $m_2$  = mass of dry material in test portion (g)  
 $m_1$  = mass of wet material in test portion (g)  
 $w_1$  = hygroscopic moisture content (%)

5.2 Calculate the mass or volume of each stabilising agent to be added as follows:

5.2.1 For a system where the agent is specified in terms of percentage by mass:

$$m_s = \frac{m_2 P_1}{100}$$

where  $m_s$  = mass of each stabilising agent (g)  
 $m_2$  = mass of dry material in test portion (g)  
 $P_1$  = stabilising agent content (%)

5.2.2 For a system where the agent is specified in terms of a rate per unit volume:

$$V_s = \frac{m_2 r}{\rho_{dm} 1000}$$

where  $V_s$  = volume of each stabilising agent (mL)  
 $m_2$  = mass of dry material in test portion (g)  
 $r$  = application rate (L/m<sup>3</sup>)  
 $\rho_{dm}$  = MDD (t/m<sup>3</sup>)

5.3 Calculate the mass or volume of each admixture as follows (Note 9.5):

5.3.1 For a system where the admixture is specified in terms of percentage by mass of stabilising agent:

$$m_a = \frac{m_s P_2}{100}$$

where  $m_a$  = mass of each admixture (g)  
 $m_s$  = mass of each stabilising agent (g)  
 $P_2$  = admixture content (%)

5.3.2 For a system where the admixture is specified in terms of volume per unit of mass of stabilising agent:

$$V_a = \frac{m_s P_3}{100000}$$

where  $V_a$  = volume of each admixture (mL)  
 $m_s$  = mass of each stabilising agent (g)  
 $P_3$  = admixture content (mL per 100 kg of stabilising agent)

5.4 Calculate the mass of mixing water to be added as follows (Note 9.6):

5.4.1 For a system containing dry stabilising agent:

$$m_3 = \frac{(m_2 + \sum m_{sd})w_2}{100} - (m_1 - m_2)$$

where  $m_3$  = mass of mixing water to be added (g) (Note 9.7)  
 $m_2$  = mass of dry material in test portion (g)  
 $\sum m_{sd}$  = sum of dry stabilising agent masses (g) (Note 9.8)  
 $w_2$  = target moisture content (%)  
 $m_1$  = mass of wet material in test portion (g)

5.4.2 For a system containing emulsion or slurry stabilising agent:

$$m_3 = \frac{(m_2 + \sum m_{sd} + m_{sw} \frac{P_4}{100})w_2}{100} - (m_1 - m_2) - \frac{m_{sw}(100 - P_4)}{100}$$

where  $m_3$  = mass of mixing water to be added (g) (Note 9.7)  
 $m_2$  = mass of dry material in test portion (g)  
 $\sum m_{sd}$  = sum of dry stabilising agent masses (g) (Note 9.8)  
 $m_{sw}$  = mass of emulsion or slurry stabilising agent (g)  
 $P_4$  = solids content of emulsion or slurry stabilising agent (%) (Note 9.8)  
 $w_2$  = target moisture content (%)  
 $m_1$  = mass of wet material in test portion (g)



5.5 For a system where a constituent is being diluted, calculate the mass of dilution water and the mass of residual mixing water as follows:

5.5.1 Dilution water for a system where the stabilising agent is specified in terms of percentage by mass:

$$m_4 = m_s DF$$

where  $m_4$  = mass of dilution water (g)  
 $m_s$  = mass of each stabilising agent (g)  
 $DF$  = dilution factor (Note 9.9)

5.5.2 Dilution water for a system where the agent is specified in terms of a rate per unit volume:

$$m_4 = V_s DF$$

where  $m_4$  = mass of dilution water (g)  
 $V_s$  = volume of each stabilising agent (mL)  
 $DF$  = dilution factor (Note 9.9)

5.5.3 Residual mixing water:

$$m_5 = m_3 - m_4$$

where  $m_5$  = mass of residual mixing water (g)  
 $m_3$  = mass of mixing water to be added (g)  
 $m_4$  = mass of dilution water (g)

## 6 Procedure – hand mixing

6.1 Test portions are to be mixed in turn with the required amount of stabilising agent and any admixture, then, conditioned prior to compaction as follows (Note 9.10):

6.2 Weigh or measure the quantity of each stabilising agent separately. Measure out separately the required mass of mixing water, mass of dilution water and mass or volume of admixture. When an admixture is to be used, include this as part of the mixing water. Add any dilution water to the constituent being diluted.

### 6.3 Lime stabilising agent

This subsection details the process for incorporation of lime where a two day mixing process would be used in the field.

6.3.1 Spread one of the test portions on the mixing tray and distribute half of the lime evenly over its surface. Thoroughly mix the lime to a uniform colour with the host material.

6.3.2 Add half of the mixing water to the material in small increments and combine thoroughly to form a uniform mixture (Note 9.11).

6.3.3 Ameliorate the mixture as follows:

- a) Compact the mixture in an appropriately sized mould in approximately 40 mm layers using one-half standard compactive effort.
- b) Demould the compacted material and seal it in plastic wrapping and place in an air curing environment for at least 12 hours but not exceeding 72 hours at  $23 \pm 2^\circ\text{C}$  (Note 9.12).

6.3.4 Repeat Steps 6.3.1 to 6.3.3 for each test portion.

6.3.5 At the end of the amelioration period, unwrap the materials, break up the mixture and add the remaining lime and mixing water by repeating Steps 6.3.1 and 6.3.2 for each portion.

6.3.6 Condition the mixture as follows:

- a) Place the mixture into a sealable container using hand pressure to consolidate the mixture. Cure the mixture for the expected field delay time, measured from the start of mixing to the commencement of compaction or from mixing of the lime to the incorporation of other stabilising agents.
- b) Otherwise, put the mixture aside to condition for 45 minutes, timed from when the remaining mixing water was first added to the mixture of host material and stabilising agent.

6.3.7 At the end of the conditioning period the mixture is ready for moulding.

#### **6.4 Dry stabilising agent**

This subsection details the process for incorporation of dry stabilising agents (such as cement, cement / flyash blends, cement / slag blends, lime / flyash, lime / slag and so on) where a one day mixing process would be used in the field.

6.4.1 Spread one of the test portions on the mixing tray and distribute the stabilising agent evenly over its surface. Thoroughly mix the agent with the material to a uniform colour. Where more than one agent is used, it may be advantageous to mix the stabilising agents together before adding them to the material.

6.4.2 Add any admixture to the mixing water and incorporate the water with the material in small increments, combining thoroughly to form a uniform mixture. If a fluid stabilising agent is also to be added, withhold a small quantity of water to be used in that operation.

6.4.3 Incorporate any fluid stabilising agent as per Subsection 6.4, otherwise place the mixture in a sealable container and put it aside to condition for 45 minutes, timed from when the mixing water was first added to the mixture of host material and stabilising agent(s).

6.4.4 Repeat Steps 6.4.1 to 6.4.3 for each test portion.

#### **6.5 Fluid stabilising agent**

6.5.1 Spread one of the test portions on the mixing tray and add most of the residual mixing water to the material in small increments while withholding a small quantity of water for rinsing the stabilising agent container. Combine the water with the material to a uniform mixture.

6.5.2 Again, spread the test portion on the mixing tray and pour the diluted stabilising agent evenly over its surface. Rinse the stabilising agent container with the remaining mixing water and thoroughly mix the agent and water with the material to a uniform colour.

6.5.3 Repeat Step 6.5.2 for each fluid stabilising agent, if appropriate.

6.5.4 Place the mixture(s) in a sealable container and put aside to condition for 45 minutes, timed from when the mixing water was first added to the mixture of host material and stabilising agent(s).

6.5.5 Repeat Steps 6.5.1 to 6.5.4 for each test portion.

## **7 Procedure – machine mixing**

Test portions are to be mixed in turn with the required amount of stabilising agent and any admixture, then conditioned prior to compaction as follows (Note 9.10).

- 7.1 Weigh or measure the quantity of each stabilising agent separately. Measure out separately the required mass of mixing water, mass of dilution water and mass or volume of admixture. When an admixture is to be used, include this as part of the mixing water. Add any dilution water to the constituent being diluted.

### **7.2 Dry stabilising agent**

This subsection details the process for incorporation of dry stabilising agents (such as cement, cement / flyash blends, cement / slag blends, lime / flyash, lime / slag and so on) where a one day mixing process would be used in the field.

- 7.2.1 Add the test portion to the mixer. Mix the test portion for 15 seconds to spread the material evenly in the mixer.
- 7.2.2 Add the dry stabilising agent evenly over the surface of the test portion. Where more than one agent is used, it may be advantageous to mix the stabilising agents together before adding them to the material.
- 7.2.3 Mix the agent with the material for 120 seconds and incorporate the water with the material in small increments, combining thoroughly to form a uniform mixture. Add any admixture to the mixing water. If a fluid stabilising agent is also to be added, withhold a small quantity of water to be used in that operation.
- 7.2.4 Allow the material to stand in the mixer for 120 seconds, then mix the agent with the material for a further 120 seconds.
- 7.2.5 Incorporate any fluid stabilising agent as per Subsection 7.3, otherwise transfer the mixture to a sealable container and put it aside to condition for 45 minutes, timed from when the mixing water was first added to the mixture of host material and stabilising agent(s). A rubber mallet, spatula and scoop may be used to assist with loosening material adhering to the interior of the mixer.
- 7.2.6 Repeat Steps 7.2.1 to 7.2.5 for each test portion.

### **7.3 Fluid stabilising agent**

- 7.3.1 Add the test portion to the mixer. Mix the test portion for 15 seconds to spread the material evenly in the mixer.
- 7.3.2 Mix the material for 120 seconds and add most of the residual mixing water to the material in small increments while withholding a small quantity of water for rinsing the stabilising agent container.
- 7.3.3 Allow the material to stand in the mixer for 120 seconds. Pour the diluted stabilising agent evenly over the surface of the mix. Rinse the stabilising agent container with the remaining mixing water and mix the agent and water with the material for a further 120 seconds.
- 7.3.4 Repeat Step 7.3.3 for each fluid stabilising agent, if appropriate.
- 7.3.5 Transfer the mixture(s) to a sealable container and put aside to condition for 45 minutes, timed from when the mixing water was first added to the mixture of host material and stabilising agent(s). A rubber mallet, spatula and scoop may be used to assist with loosening material adhering to the interior of the mixer.
- 7.3.6 Repeat Steps 7.3.1 to 7.3.5 for each test portion.

## 8 Reporting

The following shall be reported:

- 8.1 Mix details:
  - a) Source and description of the host material
  - b) Source, type, ATIC Registration number of the stabilising agent(s)
  - c) Stabilising agent(s) content(s) (%)
  - d) Admixture content (%) or Admixture volume (mL/100 kg of stabilising agent), and
  - e) Duration of amelioration (hours), for lime mixing in Subsection 6.3.
- 8.2 The number of this Test Method, that is Q135A.

## 9 Notes on method

- 9.1 The balance described in Clause 3.3 a) is suitable for most applications when adding stabilising agent to material. For small masses of material, the balance described in Clause 3.3 b) maybe required.
- 9.2 This can be provided by the supplier of the cementitious materials. Further details are available from the ATIC, *Cementitious Materials Registration Scheme (CMRS), Registered Products List*.
- 9.3 Before handling any stabilising agents or admixtures, the operator should consult the relevant SDS.
- 9.4 If the available lime index is required to be supplied with the test report, for example, Technical Specification MRTS07A *In situ Stabilised Subgrades using Quicklime or Hydrated Lime* Clause 6.2. Determine the available lime index in accordance with Test Method AS 4489.6.1: *Test methods for limes and limestones – Lime index – Available lime* and provide the test report or provide a test certificate from the lime supplier that includes the result for available lime index.
- 9.5 Admixtures may be used in conjunction with cementitious stabilising agents such as cement and blended cement. The amount used is normally related to the stabilising agent type and content.
- 9.6 When non-water based liquid stabilising agents are used, for example, cutback bitumen, no allowance is made here for its contribution to mixture fluidity when determining the mass of mixing water.
- 9.7 It is necessary to make some allowance for loss of moisture due to hydration and/or during mixing. This allowance will depend on the type of material under test, the stabilising agent content and the ambient conditions in the laboratory. Add this allowance to the calculated mass of water ( $m_3$ ).
- 9.8 The formula provides for more than one dry solids stabilising agent as well as one agent which contains both solids and water. If there is more than one stabilising agent containing solids and water, this formula will need to be modified accordingly. Where there are no dry solids, the value of  $m_{sd}$  is zero.
- 9.9 The dilution factor will depend on the mixability of the agent with the material to provide a uniform mixture. A value of about 2 is generally used for bitumen emulsion.

- 9.10 Before incorporation of the stabilising agent(s), medium and high plasticity materials must be at a significant moisture content (say 50 percent of OMC) to allow thorough and uniform incorporation of the stabilising agent(s).
- 9.11 Where other stabilising agents are to be added later, use only sufficient water to bring the lime mixture to the approximate OMC for the mixture.
- 9.12 The maximum amelioration time is specified in Technical Specification MRTS07A *In situ Stabilised Subgrades using Quicklime or Hydrated Lime*.

**Table 1 – Dimensions and tolerances for suitable moulds and rammer**

Apparatus	Dimension	Tolerance
<b>Moulds</b>		
Mould A: 105 diameter		
Internal diameter (mm)	105.0	± 0.5 *
Effective height (mm)	115.5	± 0.5 *
Nominal volume (cm <sup>3</sup> )	1000	± 15
Mould B: 152 mm diameter		
Internal diameter (mm)	152.0	± 1.0 *
Effective height (mm)	132.5	± 0.5 *
Nominal volume (cm <sup>3</sup> )	2400	± 35
<b>Rammer</b>		
Diameter; round foot (mm)	50	± 0.4
Area of rammer (mm <sup>2</sup> )	1964	± 31
Drop (mm)	300	± 2.0 ‡
Mass (kg)	2.7	± 0.01 ‡
Energy delivered per blow (J)	7.94	± 0.08
Number of layers	3	
Number of blows / layer:Mould A	25	
Mould B	60	
Energy input (kJ/m <sup>3</sup> )	596	± 14

\* Either but not both of the tolerances may be exceeded provided the specified tolerance on volume is not exceeded.

‡ Either but not both of the tolerances may be exceeded provided the appropriate tolerance on energy delivered per blow is not exceeded.

## Test Method Q135B: Curing moulded specimens of stabilised material

### 1 Source

This method was developed in-house using techniques evolved through internal departmental research investigations.

### 2 Scope

This method describes the procedures for curing laboratory and field moulded specimens containing stabilising agents under standard conditions. The procedure provides for the curing of specimens which are demoulded before testing.

### 3 Apparatus

The following apparatus is required:

#### 3.1 Air curing environment:

- a) Cabinet or environmental room for curing unsealed specimens, capable of maintaining a temperature of  $23 \pm 2^{\circ}\text{C}$  and a relative humidity  $\geq 95\%$ , or
- b) Cabinet or environmental room for curing sealed or moulded specimens, capable of maintaining a temperature of  $23 \pm 2^{\circ}\text{C}$ , or
- c) Water bath for curing sealed or moulded specimens, with a lid and raised floor to keep the specimens clear of the water. With the lid closed, the bath must be capable of maintaining a temperature of  $23 \pm 2^{\circ}\text{C}$ .

#### 3.2 Spray bottle for misting specimens.

#### 3.3 Sample extractor, such as a jack, lever frame or other device suitable for extruding compacted specimens from nominal 100 mm and 150 mm diameter moulds.

### 4 Materials

The following materials are required:

#### 4.1 Potable water for spray bottle.

#### 4.2 Heavy duty plastic wrapping (polyethylene), capable of sealing specimens against moisture loss.

#### 4.3 Heavy duty plastic bags (polyethylene), capable of sealing specimens against moisture loss.

#### 4.4 Cable ties, elastic bands or other suitable means for sealing the plastic bags.

#### 4.5 Paper, wet for wrapping specimens to maintain a moist specimen during curing.

### 5 Procedure

The procedure shall be as follows:

#### 5.1 At the completion of moulding, seal all moulds using plastic wrapping or plastic bags to prevent moisture loss (Note 7.1).

#### 5.2 For specimens which are to be demoulded before testing, proceed as follows:

- a) Place the moulded specimens in a cabinet, room or bath as specified in Step 3.1 and maintain a temperature of  $23 \pm 2^{\circ}\text{C}$  for 18 to 24 hours (Note 7.2).

- b) At the completion of this initial curing, carefully demould the specimens ensuring that specimen damage is minimised.
- c) For unsealed specimens to be placed in a cabinet or room specified in Step 3.1 a), place the specimens on a transfer plate for ease of handling.
  - i. For unsealed specimens to be placed in a cabinet or room specified in Step 3.1 a), place the specimens on a transfer plate for ease of handling.
  - ii. For sealed specimens to be placed in a cabinet, room or bath specified in Step 3.1 b) or 3.1 c):
    - lightly mist the specimens with water or wrap in wet paper
    - seal the specimens in plastic wrapping or place in a plastic bag and seal the bags
    - place the specimens on a transfer plate for ease of handling.

5.3 Cure both demoulded and moulded specimens at the standard curing conditions specified in Table 1.

5.4 At the completion of curing, remove any paper, plastic bags or wrapping to prepare the specimens for testing (Note 7.3).

## 6 Reporting

The following shall be reported:

6.1 The Curing details:

- a) duration of curing (days)
- b) type of environment used by Clause, for example, Clause 3.1 a), 3.1 b) or 3.1 c), and
- c) conditions:
  - i. for Clause 3.1 a), temperature,  $23 \pm 2^{\circ}\text{C}$ , and humidity, >95% RH
  - ii. for Clause 3.1 b), temperature,  $23 \pm 2^{\circ}\text{C}$ , or
  - iii. for Clause 3.1 c), temperature,  $23 \pm 2^{\circ}\text{C}$ .

6.2 The number of this Test Method, that is Q135B.

## 7 Notes on method

7.1 The moulded specimens may either, be placed in plastic bags and sealed, wrapped in plastic and sealed or plastic placed over the open end of the mould and secured in place using the compaction collar, elastic bands or cable ties.

7.2 If the moulded specimens are not prone to damage during early demoulding and handling, specimens may be demoulded soon after compaction. However, where material loss, delamination or change of shape is likely to occur, initially cure the specimens in their moulds for at least 18 to 24 hours. Where longer mould curing is opted for, as in the case of extremely fragile material, the total duration of curing should not exceed that which is indicated in Table 1.

7.3 Specimens should be tested immediately to prevent moisture loss.

**Table 1 – Standard curing conditions**

<b>Stabilising agent</b>	<b>Test type*</b>	<b>Curing duration and conditions</b>
Cement and cementitious blends – Plant mixed (Bound)**	Standard UCS (Production testing)	(i) 1 day air curing in mould (ii) 6 days air curing
	Standard UCS (Mix design testing)	(i) 1 day air curing in mould (ii) 6 days air curing or (i) 1 day air curing in mould (ii) 27 days air curing
	AWT (Mix design testing)	(i) 1 day air curing in mould (ii) 6 days air curing
	CR	(i) 1 day air curing in mould (ii) 27 days air curing
Cement# and cementitious blends** – Plant mixed (Lightly bound)	Standard UCS (Production testing)	(i) 1 day air curing in mould (ii) 6 days air curing or (i) 1 day air curing in mould (ii) 27 days air curing
	Standard UCS (Mix design testing)	(i) 1 day air curing in mould (ii) 6 days air curing or (i) 1 day air curing in mould (ii) 27 days air curing
	AWT (Mix design testing)	(i) 1 day air curing in mould (ii) 6 days air curing
	CR	(i) 1 day air curing in mould (ii) 27 days air curing
Cement# and cementitious blends** – In situ-mixed	Standard UCS, CR and AWT	(i) 1 day air curing in mould (ii) 6 days air curing
Lime	Standard UCS, CR and AWT	(i) 1 day air curing in mould (ii) 27 days air curing
Nil	Standard UCS for recycled blend materials	(i) 1 day air curing in mould (ii) 6 days air curing
	Standard UCS for soils	(i) 1 day air curing in mould

\* Test type abbreviations are as follows:

UCS = Unconfined Compressive Strength = Q115

CR = Capillary Rise = Q125D

AWT = Allowable Working Time = Q136A

\*\* Blends with supplementary cementitious material, for example, flyash, slag

# Cement may be replaced with lime and/or supplementary cementitious material, for example, flyash, slag.



## Test Method Q136A: Working time of stabilised materials

### 1 Source

This Test Method applies the principles of Transport for New South Wales Test Method T147: *Working time for road construction materials (Blended in the laboratory with slow setting binders)*.

### 2 Scope

This Test Method describes the procedure to determine the allowable working time of compacted specimens of soil and crushed rock materials which have been either modified or stabilised with a stabilising agent. The method has application as part of a laboratory design procedure.

Prepare test specimens by compacting passing 19.0 mm material by standard or modified compactive effort. The test is performed under the following conditions, unless otherwise specified:

- standard compaction effort
- nominated relative moisture content 100% of OMC
- stabilising agent content used will be the target content of stabilising agent, and
- specimens cured for seven days in accordance with Q135B.

### 3 Definitions

For this Test Method, the following definition shall apply:

- 3.1 Allowable working time - the time measured from the commencement of incorporation (that is, mixing) of stabilising agent into the material to completion of compaction and trimming.

### 4 Apparatus

Where appropriate, the working tolerances of apparatus are contained in Table 1.

Examples of mould and rammers are contained in AS 1289.5.1.1, Figures 1 and 2 and AS 1289.5.2.1 Figure 2.

The following apparatus is required:

- 4.1 Mould assembly (Mould A), comprising a cylindrical metal mould having an internal diameter of 105 mm and an effective height of 115.5 mm, fitted with a detachable baseplate and a removable collar assembly about 60 mm high, both of which can be firmly attached to the mould.
- 4.2 Steel rammer, having a 50 mm diameter face. For standard compactive effort, a rammer with a drop mass of 2700 g and a drop height of 300 mm. For modified compactive effort, a rammer with a drop mass of 4900 g and a drop height of 450 mm. Alternatively use a mechanical compactor, provided it meets the essential requirements of drop height, mass and energy input. A mechanical compactor may be used provided the essential dimensions are adhered to and the rammer has a free vertical fall of the correct height with blows being uniformly distributed and in keeping with any prescribed cycle of blows. The design of the compactor allows attachment of the mould to a level and rigid support base. The difference between MDD determinations using manual or mechanical compaction is less than 2%.
- 4.3 Level rigid foundation on which to compact the specimen, for example, a sound concrete floor about 100 mm or more in thickness or a concrete block of at least 100 kg mass.

- 4.4 Balance of suitable capacity, with a resolution of at least 1 g and with a limit of performance within the range of  $\pm 5$  g.
- 4.5 Sieves, 19.0 mm and 9.50 mm conforming to ISO 3310.
- 4.6 Sealable containers, suitable for curing soil samples.
- 4.7 Tool for scarifying each compacted layer, such as a trowel or spatula.
- 4.8 Material height gauge. A flat steel bar, about 250 mm long, 25 mm wide and 1-3 mm thick is satisfactory (Note 10.1).
- 4.9 Steel straightedge, about 250 mm long, 25 mm wide and 3 mm thick, preferably with one bevelled edge.
- 4.10 Mixing apparatus, such as a tray, trowel or scoop and water sprayer.

## 5 Materials

The following materials are required:

- 5.1 Mould oil, a light oil such as Caltex Mould Oil 20 (Note 10.2).

## 6 Sample preparation

The samples shall be prepared as follows:

- 6.1 Prepare the bulk sample in accordance with Section 4 of Test Method Q101 to produce a representative subsample of appropriate size. It may be necessary to dry the bulk sample before preparation so that the material is sufficiently dry to allow uniform mixing of the stabilising agent with the host material.
- 6.2 Further prepare the material by screening the subsample on a 19.0 mm sieve in accordance with Test Method Q101, Steps 5.2.1 to 5.2.2. Ensure that any aggregations are broken up to pass a 9.50 mm sieve. Discard any material retained on the 19.0 mm sieve and thoroughly remix the material passing the 19.0 mm sieve.
- 6.3 Prepare representative test portions of the sieved material in accordance with Test Method Q101, Steps 5.2.3 to 5.2.5 as follows:
  - a) at least five UCS compaction test portions. Each UCS compaction test portion must be of sufficient quantity to mould three specimens and provide a moisture sample for determining the achieved moisture content.
  - b) test portion for hygroscopic moisture content, and
  - c) four or more test portions to determine the OMC and MDD.
- 6.4 Determine the mass of each UCS test portion ( $m_1$ ) prepared in Step 6.3 a).
- 6.5 Determine the hygroscopic moisture content ( $w_1$ ) of the single test portion prepared in Step 6.3 b) in accordance with Test Method AS 1289.2.1.1.
- 6.6 Determine the OMC and MDD using the test portions prepared in Step 6.3 c) in accordance with Test Methods Q142A or Q142B as appropriate, using a Type A mould and using the specified stabilising agent content.

## 7 Working time

The procedure shall be as follows:

### 7.1 Determination of working time

7.1.1 Adopt a reference working time of one hour ( $T_R$ ).

7.1.2 Select at least 4 different working times ( $T_i$ ) greater than one hour for each sample that will provide at least two dry density determinations before and after the allowable working time (Note 10.3).

### 7.2 Compaction of specimens

7.2.1 Using the test portions prepared in Step 6.3, compact three specimens within  $\pm 15$  minutes of the selected working time, as follows:

- a) Calculate the target moisture content in accordance with Test Method Q145A.
- b) Determine the quantity of stabilising agent, then mix each test portion in accordance with Test Method Q135A (Note 10.4). Record the date and time the mixing of test portion, stabilising agent(s) and water commenced.
- c) Condition the mixture in a sealable container for the selected working time ( $T_R, T_i$ ).
- d) Clean and assemble each mould and baseplate, lightly oiling the internal surfaces. Inspect and clean the rammer or mechanical compactor and ensure that it is free in the guide.
- e) Determine the mass ( $m_2$ ) of each mould and baseplate, attach the collars and place the assemblies on the rigid foundation.
- f) At the end of the required conditioning period, remove the conditioned mixture from the container, spread the mixture on the mixing tray and thoroughly remix.
- g) Obtain a moisture sample from the mixture and determine the achieved moisture content ( $w_a$ ) in accordance with Test Method AS 1289.2.1.1.
- h) Mould the three specimens simultaneously in three equal layers using 25 rammer blows per layer, distributing the blows evenly over the surface of each layer (Note 10.5). Scarify each compacted layer to promote bonding and interlock between layers.
- i) For each mould, free the material from around the collar of the mould assembly. Then carefully remove the collar.
- j) Level the compacted specimens to the top of their respective mould using a straightedge. Employ the straightedge to patch any hollows developed in the surface using smaller sized material.
- k) Determine the mass ( $m_3$ ) of each mould, baseplate and compacted material.
- l) Record the time the moulding of the test portion is completed.
- m) Calculate the achieved dry density ( $\rho_a$ ) for each specimen in accordance with Test Method Q145A.
- n) Calculate the mean achieved dry density for each nominated working time ( $ADD_R, ADD_i$ ).
- o) Retain each test specimen in the mould and cure for seven days in accordance with Test Method Q135B.

7.2.2 Repeat Step 7.2.1 for each additional working time ( $T_i$ )

### 7.3 Unconfined Compressive Strength

- 7.3.1 Determine the UCS of each test specimen compacted and cured in Subsection 7.2 for each working time in accordance with Test Method Q115 Sections 6 to 11.
- 7.3.2 Calculate the mean UCS for each working time ( $UCS_R$ ,  $UCS_i$ )

## 8 Calculations

Calculations shall be as follows:

### 8.1 Working time for ADD

- 8.1.1 Calculate the achieved dry density at the working time as follows:

$$ADD_{TL} = 0.97ADD_R$$

where  $ADD_{TL}$  = achieved dry density at the working time (t/m<sup>3</sup>)  
 $ADD_R$  = reference achieved dry density (t/m<sup>3</sup>)

- 8.1.2 Plot the working time ( $T_R$ ,  $T_i$ ) for the compacted specimens against the corresponding mean achieved dry density ( $ADD_R$ ,  $ADD_i$ ). Draw a smooth curve of best fit through the resulting points (Refer to Figure 1) (Note 10.6).
- 8.1.3 From the plot, determine the time in hours corresponding to the intersection between the smooth curve drawn in Step 8.1.2 and the achieved dry density at the working time ( $ADD_{TL}$ ) (Refer to Figure 1). Record as the working time for ADD ( $WT_{ADD}$ ).

### 8.2 Working time for UCS

- 8.2.1 Calculate the UCS at the working time as follows:

$$UCS_{TL} = 0.80UCS_R$$

where  $UCS_{TL}$  = unconfined compressive strength at working time (MPa)  
 $UCS_R$  = reference unconfined compressive strength (Mpa)

- 8.2.2 Plot the working time ( $T_R$ ,  $T_i$ ) for the compacted specimens against the mean UCS for each working time ( $UCS_R$ ,  $UCS_i$ ). Draw a smooth curve of best fit through the resulting points (Refer to Figure 2) (Note 10.6).
- 8.2.3 From the plot, determine the time in hours corresponding to the intersection between the smooth curve drawn in Step 8.2.2 and the UCS at working time ( $UCS_{TL}$ ) (Refer to Figure 2). Record as the Working Time for UCS ( $WT_{UCS}$ )

### 8.3 Allowable working time

- 8.3.1 Calculate the Allowable Working Time (AWT) as the lower value of  $WT_{ADD}$  and  $WT_{UCS}$ .

## 9 Reporting

The following shall be reported:

- 9.1 Moisture / density relationship results:
- MDD to the nearest 0.01 t/m<sup>3</sup>
  - OMC to the nearest 0.5%

9.2 Working time:

- a) A tabulation of the following:
  - i. working time
  - ii. mean UCS to the nearest 0.05 MPa, and
  - iii. mean achieved dry density, target moisture content and achieved moisture content in accordance with Test Method Q145A.
- b) A graph of mean achieved dry density versus working time, including the curve of best fit and indication of the working time for ADD.
- c) A graph of mean UCS versus working time, including the curve of best fit and indication of the working time for UCS.
- d) Working time for ADD to the nearest 0.5 hours.
- e) Working time for UCS to the nearest 0.5 hours.
- f) The allowable working time (AWT) to the nearest 0.5 hours.

9.3 Compaction standard used, that is, standard or modified.

9.4 The number of this Test Method, that is Q136A.

## 10 Notes on method

10.1 A material height gauge which allows monitoring of the height of compacted material relative to the top of a Mould A can be made from a steel bar and marked as follows:

10.1.1 Commencing at one end of the bar, measure and mark distances of:

- a) 5.5 mm for the upper range of the third layer
- b) 33.5 to 38.5 mm for the acceptable range of the second layer, and
- c) 72.5 to 77.5 mm for the acceptable range of the first layer.

10.1.2 Mark the face with the appropriate mould size (A).

10.2 Before handling oil, the operator should consult the relevant SDS.

10.3 The usual working times will be 1, 2, 4, 8 and 24 hours. However, for slower setting stabilising agents such as lime / flyash it may be necessary to use 4, 8, 24, and 48 hours. Follow the principle in selecting time intervals where they should adequately define the curve and there should be at least two points before and after the allowable working time.

10.4 When mixing and conditioning more than one test portion, sequence the work to conform with any time for conditioning and the time to completion of compaction. Measure both times from the addition of the first increment of water to the mixture of soil and stabilising agent.

10.5 It may be advantageous to perform simultaneous compaction of the specimens where compaction is performed by compacting the same layer in each mould one after the other.

10.6 The smooth curve will usually be defined by the relationship  $y = a \ln(x) + b$ . Refer to Figures 1 and 2 for examples.

**Table 1 – Dimensions and tolerances for suitable mould and rammers**

Apparatus	Dimension	Tolerance
<b>Mould</b>		
Mould A: 105 diameter		
Internal diameter (mm)	105.0	± 0.5
Effective height (mm)	115.5	± 0.5
Nominal volume (cm <sup>3</sup> )	1000	± 15
<b>Rammer (standard)</b>		
Diameter; round foot (mm)	50	± 0.4
Area of rammer (mm <sup>2</sup> )	1964	± 31
Drop (mm)	300	± 2.0 ‡
Mass (kg)	2.7	± 0.01 ‡
Energy delivered per blow (J)	7.94	± 0.08
Number of layers	3	
Number of blows / layer:Mould A	25	
Energy input (kJ/m <sup>3</sup> )	596	± 14
<b>Rammer (modified)</b>		
Diameter; round foot (mm)	50	± 0.4
Area of rammer (mm <sup>2</sup> )	1964	± 31
Drop (mm)	450	± 2.0 ‡
Mass (kg)	4.9	± 0.01 ‡
Energy delivered per blow (J)	21.62	± 0.08
Number of layers	5	
Number of blows / layer:Mould A	25	
Energy input (kJ/m <sup>3</sup> )	2703	± 60

\* Either but not both of the tolerances may be exceeded provided the specified tolerance on volume is not exceeded.

‡ Either but not both of the tolerances may be exceeded provided the appropriate tolerance on energy delivered per blow is not exceeded.

Figure 1 – Working time for Achieved Dry Density

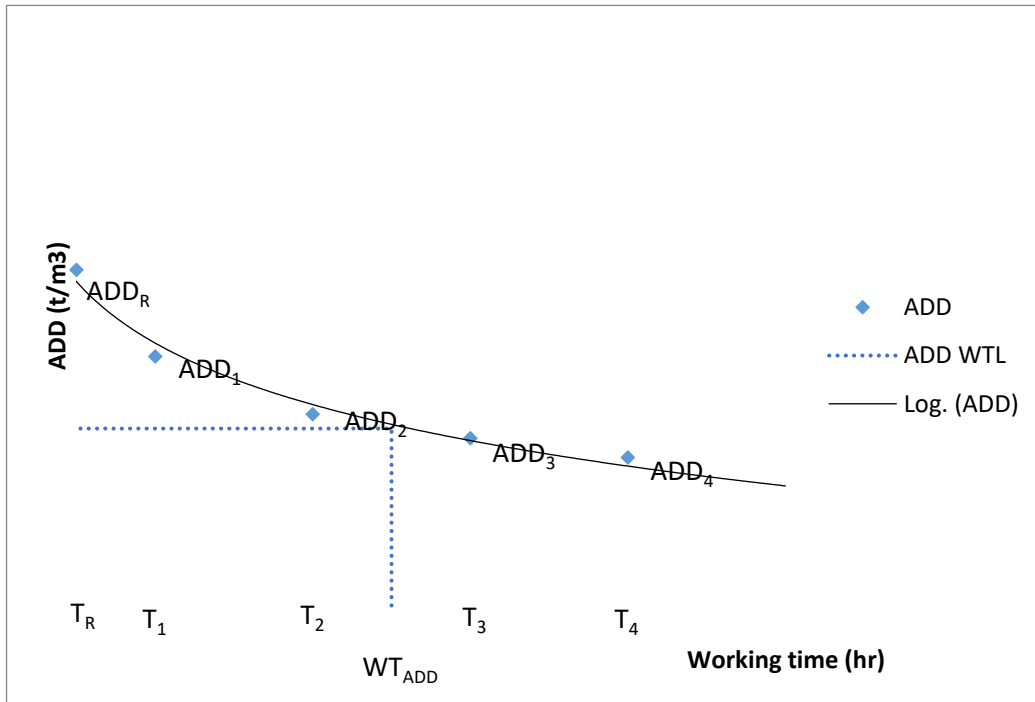
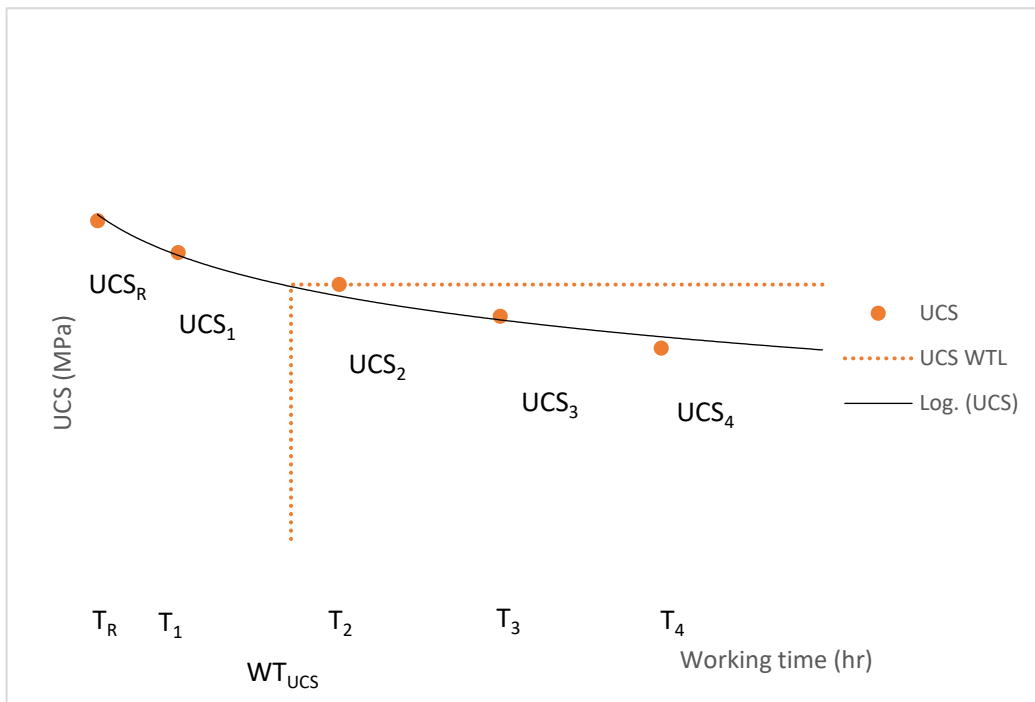

Figure 2 – Working time for UCS



## Test Method Q136B: Working time of foamed bitumen stabilised materials

### 1 Source

This Test Method applies the principles of Transport for New South Wales Test Method T147: Working time for road construction materials (Blended in the laboratory with slow setting binders) to the determination of working time for foamed bitumen stabilised materials.

### 2 Scope

This Test Method describes the procedure to determine the allowable working time of compacted specimens of soil and crushed rock materials that have been stabilised with foamed bitumen and a secondary stabilising agent such as hydrated lime or hydrated lime / flyash blends.

Prepare test specimens by compacting passing 37.5 mm material as detailed in Test Method Q138A. The stabilising agent contents used will usually be the target stabilising agent contents.

### 3 Definitions

For this Test Method, the following definition shall apply:

- 3.1 Allowable working time – the time measured from the commencement of incorporation (that is, mixing) of stabilising agent into the material to completion of compaction and trimming.

### 4 Apparatus

Example of sample divider (riffle) is contained in AS 1141.2 Figure 1.

Where appropriate the working tolerances of apparatus are contained in Table 1.

The following apparatus is required:

#### 4.1 Compaction equipment

Examples of the apparatus are shown in ASTM D5581 Figures 1 to 3.

- 4.1.1 Cylindrical steel compaction mould having an internal diameter of 152.4 mm, a height of 114.3 mm and a thickness of 12.7 mm; a mould base with a thickness of 12.7 mm and an extension collar having an internal diameter of 155.6 mm, a height of 82.6 mm and a thickness of 4.75 mm. The mould base will be removable and fits the compaction pedestal.
- 4.1.2 Hand compaction hammer, consisting of a flat circular tamping face having a diameter of 149.4 mm, and a sliding weight with a mass of 10.21 kg and a free fall of 457.2 mm (Note 11.1).



- 4.1.3 Hand compaction pedestal, consisting of the following:
- a) a wooden block, of approximate dimensions 200 mm square and 450 mm thick, capped by a steel plate of approximate dimensions 300 mm square and 25 mm thick. An air-dry density of the wooden block of 720 kg/m<sup>3</sup>. With the steel plate securely attached to the block that is secured to a solid concrete floor or slab. Suitable guides for restraining the compaction mould and locating the compaction hammer centrally during compaction may be attached to the block, or
  - b) a concrete block, of approximate dimensions 360 mm square and 610 mm thick. Suitable guides for restraining the compaction mould and locating the compaction hammer centrally during compaction may be attached to the block, or
  - c) a steel post (circular or square cross-section), of approximate dimensions 150 mm diameter / square and 620 mm thick. Suitable guides for restraining the compaction mould and locating the compaction hammer centrally during compaction may be attached to the block.
- 4.1.4 Specimen extrusion jack, consisting of a hydraulic jack fitted with a plate on the ram and located within a metal frame. With, a plate of 151.5 mm diameter and 12 mm thick for 150 mm diameter test specimens and a metal frame able to retain the mould during extrusion of a test specimen.
- 4.2 Balance of suitable capacity, having a resolution of at least 0.1 g and with a limit of performance within the range of  $\pm 0.5$  g.
- 4.3 Sieves, 37.5 mm and 9.50 mm, conforming to ISO 3310.
- 4.4 Stopwatch with a resolution not exceeding 0.1 seconds.
- 4.5 Sample divider (riffle), conforming to the requirements of AS 1141.2.
- 4.6 Callipers, with a resolution not greater than 0.1 mm conforming to ISO 13385-1 or JIS B7507.
- 4.7 Container for storing manufactured material.

## 5 Materials

The following materials are required:

- 5.1 Filter paper (Whatman No. 1 or equivalent).

## 6 Sample preparation

The sample shall be prepared as follows:

- 6.1 Prepare the bulk sample in accordance with Section 4 of Test Method Q101 to produce a representative subsample of at least 100 kg.
- 6.2 Further prepare the material by screening the subsample on a 37.5 mm sieve in accordance with Test Method Q101, Steps 5.2.1 to 5.2.2. Ensure that any aggregations are broken up to pass a 37.5 mm sieve. Discard any material retained on the 37.5 mm sieve and thoroughly remix the material passing the 37.5 mm sieve.

- 6.3 Prepare representative test portions of the sieved material in accordance with Test Method Q101, Steps 5.2.3 to 5.2.5 as follows:
- a) minimum of four test portions of 13,000 g for foamed bitumen testing and determine the mass of each test portion ( $m_1$ ) (Note 11.2)
  - b) test portion for hygroscopic moisture content, and
  - c) four or more test portions to determine the OMC and MDD.
- 6.4 Determine the hygroscopic moisture content ( $w_1$ ) of the test portion prepared in Step 6.3 b) in accordance with Test Method AS 1289.2.1.1.
- 6.5 Determine the OMC and MDD using the test portions prepared in Step 6.3 c) in accordance with Test Methods Q142A or Q142B as appropriate. If all material passes the 19.0 mm sieve in Step 6.2, use a Type A mould; otherwise, use the Type B mould.

## 7 Production of test specimens

The test specimens shall be produced as follows:

- 7.1 For each foamed bitumen test portion:
- 7.1.1 Using the procedure in accordance with Test Method Q135A with nominated dry stabilising agent content ( $p_1$ ), calculate the dry mass of each test portion ( $m_2$ ) and mass of stabilising agent (lime or lime / flyash) ( $m_s$ ).
  - 7.1.2 Using the procedure in accordance with Test Method Q254A with the optimum moisture content ( $w_o$ ), dry mass of each test portion ( $m_2$ ) and mass of stabilising agent (lime or lime / flyash) ( $m_s$ ), calculate the required quantities, prepare the foaming apparatus and produce foamed bitumen material.
  - 7.1.3 Repeat Steps 7.1.1 to 7.1.2 with remaining test portions prepared in Step 6.3 a). When completed recombine the mixed materials and thoroughly mix using the sample divider (riffle).
  - 7.1.4 Prepare 18 or more representative test portions of the foamed material in accordance with Test Method Q101, Steps 5.2.4 to 5.2.6, of sufficient quantity to produce a specimen of 60 - 80 mm in height (Note 11.3).
  - 7.1.5 Obtain a moisture sample from the mixture and determine the achieved moisture content ( $w_a$ ) in accordance with Test Method AS 1289.2.1.1.

## 8 Working time

The procedure shall be as follows:

### 8.1 Determination of working time

- 8.1.1 Adopt a reference working time of one hour ( $T_R$ ).
- 8.1.2 Select at least five different working times ( $T_i$ ) starting at eight hours and increasing in intervals of two hours (Note 11.4).

## 8.2 Compaction of specimens

- 8.2.1 Using the test portions prepared in Step 7.1.4 compact three specimens in accordance with Test Method Q138A Subsection 6.2 as follows:
- record the date and time the mixing of test portion, stabilising agent(s) and water is commenced.
  - condition the mixture in an airtight container for the selected working time ( $T_R, T_i$ ).
  - remove the conditioned mixture from the container and mould the three specimens in accordance with Test Method Q138A Subsection 6.2 within  $\pm 15$  minutes of the selected working time (Note 11.5).
  - record the time the moulding of the test portion is completed.
- 8.2.2 Repeat Step 8.2.1 for each additional working time ( $T_i$ ).

## 8.3 Three day soaked modulus

Determine the three day cured modulus and three day soaked modulus for each test specimens compacted in Subsection 8.2 for each working time as follows:

- 8.3.1 Following extrusion of specimens from the compaction moulds, perform oven curing of the three specimens in accordance with Test Method Q254B Step 5.2.
- 8.3.2 After the oven curing, measure and test the specimens at  $72 \pm 1.0$  hours from completion of compaction in accordance with Steps 6.1 to 6.5 of Test Method Q139 to determine the three day cured modulus.
- 8.3.3 Following the three day cured modulus testing, perform the vacuum soaking of the specimens in accordance with Test Method Q254B Step 5.3.
- 8.3.4 After the vacuum soaking, test the specimens in accordance with Steps 6.1.5 to 6.5 of Test Method Q139 to determine the soaked modulus.

Calculate the mean three day soaked modulus for each working time ( $SM_{3R}, SM_{3i}$ ) in accordance with Section 7 of Test Method Q139. Also calculate the mean three day cured modulus and retained modulus in accordance with Section 7 of Test Method Q139.

## 9 Calculations

Calculations shall be as follows:

### 9.1 Working time for three day soaked modulus

- 9.1.1 Calculate the three day soaked modulus at the working time as follows:

$$SM_{WT} = 0.80SM_R$$

where  $SM_{WT}$  = three day soaked modulus at the working time (MPa)  
 $SM_R$  = reference three day soaked modulus (MPa)

- 9.1.2 Plot the working time ( $T_R, T_i$ ) for the compacted specimens against the corresponding mean three day soaked modulus ( $SM_{3R}, SM_{3i}$ ). Draw a smooth curve of best fit through the resulting points (refer to Figure 1).

- 9.1.3 From the plot, determine the time in hours corresponding to the intersection between the smooth curve drawn in Step 9.1.2 and the three day soaked modulus at the working time ( $SM_{WT}$ ) (refer to Figure 1). Record as the working time for three day soaked modulus ( $WT_{SM}$ ). This will also be the allowable working time (AWT) for the foamed bitumen material.

## 10 Reporting

The following shall be reported:

- 10.1 Moisture / density relationship results:
- MDD to the nearest 0.01 t/m<sup>3</sup>
  - OMC to the nearest 0.5%
- 10.2 Working time:
- A tabulation of working time and mean three day soaked modulus to the nearest 50 MPa
  - A graph of mean three day soaked modulus versus working time, including the curve of best fit and indication of the working time for three day soaked modulus
  - Working time for three day soaked modulus to the nearest 0.5 hours, and
  - The AWT to the nearest 0.5 hours.
- 10.3 Compaction:
- Achieved moisture content to the nearest 0.1%.
- 10.4 The number of this Test Method, that is Q136B

## 11 Notes on method

- 11.1 Where a mechanical compactor is used instead of the hand compactor, the mass, free fall and design of the hammer foot should be identical to those of the hand compaction hammer and the automatic compactor should be securely anchored to a base. Mechanical compactors will typically apply blows at a rate of about 50 blows / minute.
- 11.2 The combined test portion mass of 26 kg will be adequate for most materials. This is required to ensure the mixer has sufficient material to mix effectively and ensure the foamed bitumen can be incorporated with minimal loss. To produce sufficient material for 18 specimens, two charges of the mixer will be required.
- 11.3 All samples should be essentially the same mass, a tolerance of  $\pm 2$  g has been found to be suitable.
- 11.4 The usual working times will be 8, 10, 12, 14 and 16 hours.
- 11.5 When mixing and conditioning more than one test portion, sequence the work such that any time for conditioning and the time to completion of compaction are observed. These times are measured from when the first increment of water is added to the mixture of material and lime or lime / flyash.

**Table 1 – Dimensions and tolerances for compaction apparatus**

Apparatus	Dimension	Tolerance
<b>Mould</b>		
Internal diameter (mm)	152.40	± 0.2
<b>Hammer</b>		
Tamping face diameter (mm)	149.4	± 0.1
Sliding weight mass (kg)	10.21	± 0.01
Free fall (mm)	457.2	± 2.5

**Figure 1 – Working time for three day soaked modulus**

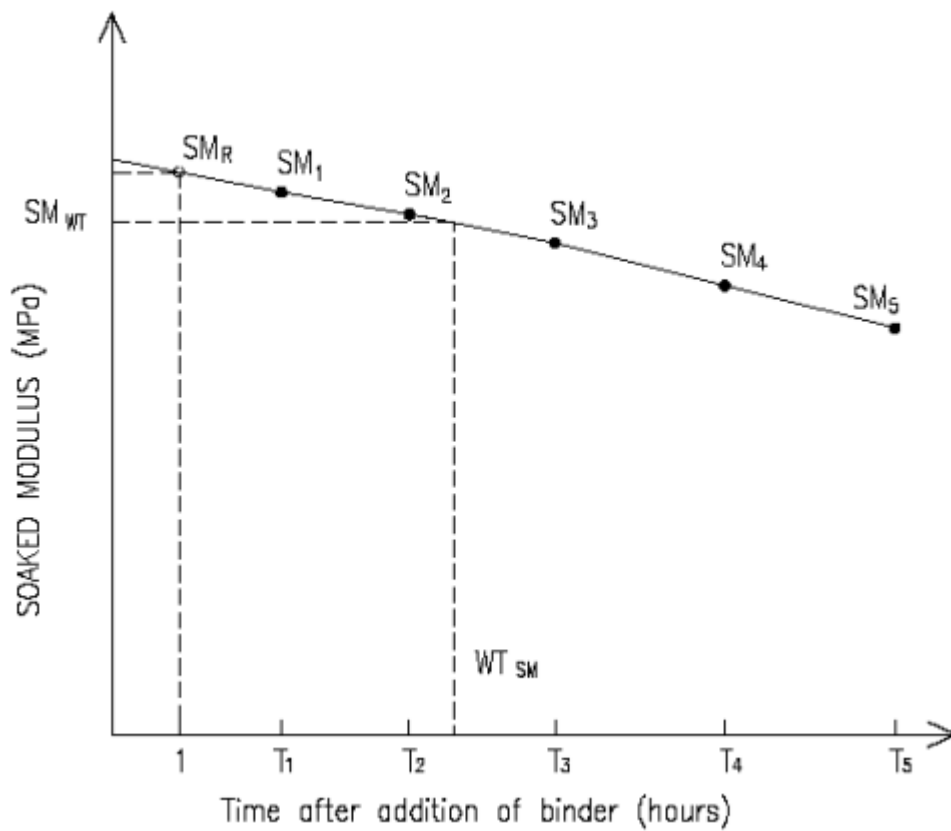

## Test Method Q137: Permanent deformation and resilient modulus of unbound material

### 1 Source

This Test Method applies the principles of AS 1289.6.8.1: *Methods of testing soils for engineering purposes - Soil strength and consolidation tests - Determination of the resilient modulus and permanent deformation of unbound pavement materials*.

This Test Method was developed in-house using techniques evolved through internal departmental research investigations into the characterization of material performance since 2000. The primary differences between this Test Method and other approaches are:

- i) testing three specimens at a nominated density over a range of moisture contents (expressed in terms of the degree of saturation of the specimen). In examining the permanent deformation responses of the specimens at different degrees of saturation, the extent of the sensitivity to moisture changes for a material can be assessed
- ii) applying a constant stress ratio of 750/125 kPa to each specimens for 100,000 cycles of load/unload, and
- iii) performing the test under undrained conditions with pore pressure measurements.

Additional information was referenced from Head KH (1982) *Manual of Soil Laboratory Testing, Vol. 2*, Pentech Press, London, Paragraph 13.3.8.

### 2 Scope

This Test Method covers the determination of the permanent deformation and the resilient modulus of an unbound material (maximum particle size not exceeding 19 mm) under the action of cyclic vertical loading measured using repeated load triaxial equipment.

A minimum of three specimens of unbound material are prepared to a nominated dry density or relative compaction and to a moisture content corresponding to a target DoS. The DoS target values for all three specimens should be selected such that there is an adequate range over which to compare the performance of the specimens.

Subject each specimen to 100,000 cycles of loading and unloading using a constant vertical stress, under undrained conditions, at a constant confining pressure. The permanent deformation and pore water pressure responses to loading and the resilient modulus properties of the material are measured under these conditions.

### 3 Apparatus

Where appropriate, the working tolerances of apparatus are contained in Tables 1 and 2.

Examples of rammers are contained in AS 1289.5.1.1, Figure 2 and AS 1289.5.2.1 Figure 2.

The following apparatus is required:

- 3.1 Dynamic loading equipment capable of applying a vertical dynamic force of up to 10 kN and a static confining pressure of up to 500 kPa (generally an incompressible fluid such as water is used as the confining medium) (Figure 1). The equipment consists of the following:
- a) Vertical dynamic force loading cycle with a period of 3 seconds with rise and fall times of up to 0.3 seconds and load pulse width of 1 second (Figure 2).
  - b) Device for vertical load measurement conforms to the requirements of AS 2193 for Class A testing machines. A load measuring device that can be operated from within the triaxial cell is recommended for the determination of the modulus for the specimen (for example, internal submersible load cell).
  - c) Loading equipment capable of providing at least 100,000 vertical load cycles continuously.
  - d) Static confining pressure controllable within 2.5 kPa of the required applied pressure and measured at the base of the triaxial cell using a device that conforms to the accuracy requirements of AS 1349 for industrial gauges.
  - e) Standard triaxial cell for 100 mm diameter specimens, with a working pressure of at least 500 kPa.
  - f) Porous plate to be in contact with the specimen and the base pedestal of the standard triaxial cell. The porous plates may be made of silicon carbide, aluminium oxide or sintered bronze. Other materials may be used provided they are not attacked by soil or soil moisture. The plates are sufficiently rigid to withstand the pressures applied without changes in physical properties. The plates are sufficiently fine so that soil will not extrude into the pores, but sufficiently coarse to have a permeability appreciably greater than the soil specimen.
  - g) Vertical displacement measuring device with a range of 20 mm, for a gauge length equal to the height of the specimen conforms to the accuracy and repeatability requirements for a Grade B extensometer as defined in AS 1545.
  - h) Distance measuring device for measuring the length and diameter of each specimen to an accuracy of  $\pm 0.2\%$ .
  - i) Computer and data acquisition equipment capable of recording the data from the load, displacement, and pore water pressure measuring devices to the required accuracy.
- 3.2 Sieves, 19.0 mm and 9.50 mm conforms to ISO 3310.
- 3.3 Steel rammer, having a 50 mm diameter face. For standard compactive effort, a rammer with a drop mass of 2700 g and a drop height of 300 mm. For modified compactive effort, a rammer with a drop mass of 4900 g and a drop height of 450 mm.
- 3.4 Cylindrical split metal mould capable of producing a specimen 100 mm diameter and 200 mm high with a collar of sufficient height to permit the filling of the mould in layers with loose soil prior to compaction.
- 3.5 Material height gauge. A flat steel bar, about 250 mm long, 25 mm wide and 1-3 mm thick is satisfactory (Note 10.1).
- 3.6 Mixing apparatus, such as a tray, trowel or scoop and water sprayer.

- 3.7 Seamless rubber membrane in the form of a tube, open at both ends, of internal diameter equal to that of the specimen and length about 50 mm greater than that of the specimen and of 0.3 mm to 0.60 mm thickness. For materials with an appreciable proportion of coarse-grained particles, a recommended thickness of 0.6 mm to reduce the risk of membrane rupture during testing.
- 3.8 Membrane stretcher to suit the size of specimen.
- 3.9 Rubber rings of circular cross-section to suit the diameter of the end caps.
- 3.10 Balance of suitable capacity, having a resolution of at least 1 g and with a limit of performance within the range of  $\pm 5$  g.

#### 4 Materials

The following material is required:

- 4.1 Mould oil, a light mould oil such as Caltex Mould Oil 20 (Note 10.2).

#### 5 Sample preparation

The sample shall be prepared as follows:

- 5.1 Prepare the bulk sample in accordance with Section 4 of Test Method Q101 to produce a representative subsample of at least 100 kg.
- 5.2 Further prepare the material by screening the subsample on a 19.0 mm sieve in accordance with Test Method Q101, Steps 5.2.1 to 5.2.2. Ensure that any aggregations are broken up to pass a 9.50 mm sieve and retain any oversize material. Thoroughly remix the material passing the 19.0 mm sieve.
- 5.3 Where oversize is retained on the 19.0 mm sieve, determine its mass ( $m_{ow}$ ) and the mass of the passing 37.5 mm (undersize) material ( $m_{uw}$ ). Calculate the percentage oversize on a wet mass basis as follows:

$$P_{ow} = \frac{100m_{ow}}{m_{ow} + m_{uw}}$$

where  $P_{ow}$  = percentage by wet mass of oversize  
 $m_{ow}$  = wet mass of oversize (g)  
 $m_{uw}$  = wet mass of undersize (g)

- 5.4 Discard any material retained on the 19.0 mm sieve.
- 5.5 Prepare representative test portions of the sieved material in accordance with Test Method Q101, Steps 5.2.3 to 5.2.5 as follows:
  - a) minimum of 3 test portions for repeated load triaxial testing
  - b) test portion for hygroscopic moisture content
  - c) test portion for soil particle density, and
  - d) four or more test portions to determine the OMC and MDD.
- 5.6 Determine the mass of each test portion prepared in Step 5.4 a) ( $m_1$ ).
- 5.7 Determine the hygroscopic moisture content ( $w_1$ ) of the test portion prepared in Step 5.4 b) in accordance with Test Method AS 1289.2.1.1.



- 5.8 Determine the soil particle density ( $\rho_s$ ) of the test portion prepared in Step 5.4 c) in accordance with Test Method AS 1289.3.5.1.
- 5.9 Determine the OMC and MDD of the test portions prepared in Step 5.4 d) in accordance with Test Methods Q142A or Q142B as appropriate, using a Type A mould and using the specified curing time for the material in Test Method Q255 Table 1.

## 6 Preparation of test specimens

The test specimens shall be prepared as follows:

### 6.1 Curing

- 6.2 Calculate the target moisture content ( $w_t$ ) and target dry density to achieve either the nominated relative compaction and nominated relative moisture content or the nominated relative compaction and nominated DoS in accordance with Test Method Q145A.
- 6.3 Calculate the dry mass of each test portion ( $m_2$ ) and mass of mixing water to be added ( $m_3$ ), then mix and cure each the test portion in accordance with Test Method Q255.

### 6.4 Compaction

Compact the test specimens as follows:

- 6.4.1 Undertake all necessary calculations, mould preparation and compaction of the test portion in accordance with Test Method Q145A to achieve the nominated relative compaction and nominated relative moisture content or nominated DoS. Compacting each specimen in six equal layers for standard compaction or ten equal layers for modified compaction.
- 6.4.2 For non-cohesive material, the specimen is likely to collapse during demoulding (or extrusion) from the mould. For these circumstances, the mould may be lined with a rubber or plastic membrane to hold the specimen together after demoulding. When required, make corrections for the mass and volume of the membrane (Note 10.3). If the membrane is punctured during compaction, a second membrane will be required for the test.

## 7 Repeat load triaxial testing

The repeat load triaxial testing shall be performed as follows:

### 7.1 Specimen assembly

- 7.1.1 Place the triaxial cell base on the platform of the loading machine.
- 7.1.2 Ensure the pore water pressure port is filled with water and free of air.
- 7.1.3 Place a deaired porous plate on the base pedestal of the triaxial cell. A filter paper disc may be placed between the soil specimen and the porous plate.
- 7.1.4 Initialise the pore water pressure transducer and record the zero measurement ( $\mu_1$ ).
- 7.1.5 To ensure that the test is performed undrained, ensure the back pressure port valve is closed.
- 7.1.6 Invert the specimen and mould and place centrally on the base pedestal such that the top face of the specimen is in contact with the pedestal. Remove the specimen from the mould by disassembling the split mould. Ensure that the specimen is not damaged during the demoulding process.
- 7.1.7 Measure the length ( $h_s$ ) and diameter ( $d_s$ ) of the specimen to the nearest 0.5 mm (Note 10.4).

- 7.1.8 Place the loading cap on top of the specimen. Using the membrane stretcher, place the rubber membrane around the specimen and seal the membrane at both end platens by means of the rubber rings.
- 7.1.9 Assemble the triaxial cell into position ensuring that the loading ram is seated centrally in the load cap. Adjust the position of the load cell to ensure it is set up within its calibrated range and initialise the reading.
- 7.1.10 Attach the displacement measuring device to the loading ram so that it is set up to operate within its calibrated range and initialise the reading.
- 7.1.11 Initialise the confining pressure transducer reading and record the zero measurement ( $\sigma_{3(1)}$ ). Fill the cell with de-aired water to be used for applying the confining pressure and remove any air bubbles.

## 7.2 Cyclic loading

Perform the cyclic loading as follows:

- 7.2.1 Apply and hold a confining pressure of 125 kPa to the test specimen. Record the actual confining pressure achieved ( $\sigma_{3(2)}$ ).
- 7.2.2 Monitor the increase in pore water pressure until a maximum value is reached. Record the maximum pore water pressure observed ( $\mu_2$ ).
- 7.2.3 Apply loading / unloading cycles (Figures 2 and 3) using a target total vertical stress of 750 kPa to the specimen for 100,000 loading cycles or until the permanent deformation of the specimen exceeds the limitations of the testing system.
- 7.2.4 Remove the specimen from the cell.
- 7.2.5 Repeat this procedure for each test specimen.

## 8 Calculations

Calculations shall be as follows:

- 8.1 Using the achieved moisture content, calculate the achieved dry density, achieved relative compaction and achieved relative moisture content or achieved DoS in accordance with Test Method Q145A.
- 8.2 Compare the achieved dry density and target dry density. If they differ by more than 0.02 t/m<sup>3</sup>, discard the specimen, and repeat the preparation to Q145A for the nominated conditions.
- 8.3 Compare the achieved DoS and the nominated DoS. If they differ by more than 4%, discard the specimen, and repeat the preparation to Q145A for the nominated conditions.
- 8.4 Calculate the cross-sectional area of each specimen as follows:

$$A = -\frac{\pi d_s^2}{4} 10^{-6}$$

- where  $A$  = Cross-sectional area of the specimen ( $m^2$ )  
 $d_s$  = diameter of the specimen (mm)

8.5 Calculate the dry density ( $\rho_d$ ) of the specimen as follows:

$$\rho_d = \frac{(m_2 - m_1)10^5}{Ah_s(100 + w_a)}$$

- where
- $\rho_d$  = dry density of the specimen (t/m<sup>3</sup>)
  - $m_2$  = the mass of specimen, mould and collar, and baseplate if applicable (g)
  - $m_1$  = the mass of the mould and collar, and baseplate if applicable (g)
  - $A$  = cross-sectional area of the specimen (m<sup>2</sup>)
  - $h_s$  = the height of the specimen (mm)
  - $w_a$  = achieved moisture content of the specimen (%)

8.6 Calculate the pore pressure coefficient (B) for the initial application of confining pressure as follows:

$$B = \frac{\mu_2 - \mu_1}{\sigma_{3(2)} - \sigma_{3(1)}}$$

- where
- B = pore pressure coefficient
  - $\mu_1$  = initial pore water pressure (kPa)
  - $\mu_2$  = maximum pore water pressure after application of confining pressure, prior to the commencement of loading cycles (kPa)
  - $\sigma_{3(1)}$  = initial confining pressure (kPa)
  - $\sigma_{3(2)}$  = maximum applied confining pressure (kPa)

8.7 Calculate the deviator stress ( $\sigma_{d(n)}$ ) at any loading cycle (n), where recordings are made as follows:

$$\sigma_{d(n)} = \sigma_{1(n)} - \sigma_{3(n)} = \left(\frac{F_v}{A}\right) - \sigma_{3(n)} \left[1 - \frac{(A-a)}{A}\right]$$

- where
- $\sigma_{d(n)}$  = the deviator stress for that cycle (Notes 10.5, 10.6 and 10.7) (kPa)
  - $\sigma_{1(n)}$  = the maximum vertical stress applied to the specimen (Notes 10.5, 10.6 and 10.7) for that cycle (kPa)
  - $\sigma_{3(n)}$  = the confining stress applied to the specimen (kPa)
  - $F_v$  = the vertical force applied to the loading ram (kN)
  - $A$  = the cross-sectional area of the specimen (m<sup>2</sup>)
  - $a$  = the cross-sectional area of the loading ram (m<sup>2</sup>)

8.8 For the resilient modulus at the completion of each loading cycle ( $n$ ), calculate as follows:

8.8.1 The gauge length ( $l_{g(n)}$ ) over which the resilient deformation is measured (Note 10.6) for that cycle as follows:

$$l_{g(n)} = l_i - (\delta_{4(n-1)} - \delta_1)$$

where	$l_{g(n)}$	=	gauge length over which the deformation is measured for that cycle (mm)
	$l_i$	=	the initial gauge length, that is, the initial height of the specimen ( $h_s$ ) (mm)
	$\delta_{4(n-1)}$	=	vertical displacement with the confining stress ( $\delta_3$ ) applied and the vertical force $F$ , released for the previous cycle (mm)
	$\delta_1$	=	vertical displacement at the commencement of the test with no confining stress ( $\delta_3$ ) and no vertical force ( $F_v$ ), applied (mm) (Figure 3)
	$n$	=	the cycle number

8.8.2 The resilient vertical strain ( $\varepsilon_{r(n)}$ ) as follows:

$$\varepsilon_{r(n)} = \frac{(\delta_{3(n)} - \delta_{4(n)})100}{l_{g(n)}}$$

where	$\varepsilon_{r(n)}$	=	resilient vertical strain (%)
	$\delta_{3(n)}$	=	vertical displacement with the confining stress and the deviator stress applied (mm)
	$\delta_{4(n)}$	=	vertical displacement with the confining stress applied and the deviator stress released (mm) (Figure 3)
	$l_{g(n)}$	=	gauge length over which the deformation is measured for that cycle (mm)

8.8.3 The resilient modulus ( $E_{r(n)}$ ) at the  $n$ th cycle as follows:

$$E_{r(n)} = \frac{\sigma_{d(n)}}{\varepsilon_{r(n)}} 10^{-1}$$

where	$E_{r(n)}$	=	the resilient modulus at that cycle (MPa)
	$\sigma_{d(n)}$	=	the deviator stress at that cycle (kPa)
	$\varepsilon_{r(n)}$	=	the resilient vertical strain at that cycle (%)

8.9 For the permanent vertical strain ( $\varepsilon_{p(n)}$ ) at any loading cycle ( $n$ ), calculate as follows:

$$\varepsilon_{p(n)} = \frac{(\delta_{4(n)} - \delta_2)100}{l_i}$$

where	$\varepsilon_{p(n)}$	=	permanent vertical strain at that cycle (%)
	$\delta_{4(n)}$	=	vertical displacement with the continuing stress applied and the deviator stress released (mm) (Figure 3)
	$\delta_2$	=	vertical displacement when the confining stress is first applied (mm)
	$l_i$	=	the initial gauge length, that is, the initial height of the specimen ( $h_s$ ) (mm)

## 9 Reporting

The following shall be reported:

### 9.1 Specimen details:

- a) Specimen preparation details, including the method of placement and drainage conditions.
- b) The percentage of oversize material retained on 19.0 mm sieve.

### 9.2 Moisture / density relationship results:

- a) MDD to the nearest 0.01 t/m<sup>3</sup>
- b) OMC to the nearest 0.5%

### 9.3 Soil particle density results:

- a) Soil particle density to the nearest 0.01 t/m<sup>3</sup>, and

### 9.4 The following in accordance with Test Method Q145A:

- a) Nominated relative compaction and nominated relative moisture content or nominated DoS.
- b) Target dry density, target moisture content.
- c) Achieved dry density, achieved relative compaction, achieved moisture content and achieved relative moisture content or achieved DoS.

### 9.5 Test results:

- a) The nominal vertical stress and the nominal confining stress applied to the specimen to the nearest 1 kPa.
- b) The pore pressure coefficient to the nearest 0.01.
- c) The values of the parameters below for the following nominal loading cycle counts; 1, 100, 1000, 5000, 10000, 25000, 50000, 75000, and 100,000:
  - i. cycle number (n).
  - ii. permanent strain to the nearest 0.01%.
  - iii. resilient strain to the nearest 0.01%.
  - iv. resilient modulus to the nearest 10 MPa.
  - v. pore water pressure to the nearest 1 kPa.
- d) Plots of the permanent strain, resilient strain, resilient modulus and pore water pressure as a function of the cycle number (n).
- e) Permanent strain limits on plot of permanent strain as a function of the cycle number (n) (refer to Table 3).

### 9.6 The number of this Test Method, that is Q137.

## 10 Notes on method

- 10.1 A material height gauge, which allows monitoring of the height of compacted material relative to the top of the RLT mould, can be made from a steel bar as follows:
- 10.1.1 RLT mould – Standard (Std) compaction.
- Commencing at one end of the bar, measure and mark distances of:
- 5.5 mm for the upper range of the sixth layer
  - 30.5 mm and 35.5 mm for the acceptable range of the fifth layer
  - 64.0 mm and 69.0 mm for the acceptable range of the fourth layer
  - 97.5 mm and 102.5 mm for the acceptable range of the third layer
  - 131.0 mm and 136.0 mm for the acceptable range of the second layer, and
  - 164.0 mm and 169.0 mm for the acceptable range of the first layer.
- 10.1.2 RLT Mould – Modified (Mod) compaction.
- Commencing at one end of the bar, measure and mark distances of:
- 5.5 mm for the upper range of the tenth layer
  - 17.5 mm and 22.5 mm for the acceptable range of the ninth layer
  - 37.5 mm and 42.5 mm for the acceptable range of the eighth layer
  - 57.5 mm and 62.5 mm for the acceptable range of the seventh layer
  - 77.5 mm and 82.5 mm for the acceptable range of the sixth layer
  - 97.5 mm and 102.5 mm for the acceptable range of the fifth layer
  - 117.5 mm and 122.5 mm for the acceptable range of the fourth layer
  - 137.5 mm and 142.5 mm for the acceptable range of the third layer
  - 157.5 mm and 162.5 mm for the acceptable range of the second layer, and
  - 177.5 mm and 182.5 mm for the acceptable range of the first layer.
- 10.1.3 Mark each face with the appropriate compactive effort (Std or Mod).
- 10.2 Before handling oil, the operator should consult the relevant SDS.
- 10.3 Membrane correction - where significant axial strains occur (that is, >2%) or multiple membranes are used, membrane corrections may be significant and should be applied to the calculation of the deviator stress, in accordance with the reference in Section 1.
- 10.4 For fragile materials the internal dimensions of the mould may be measured to avoid damaging the compacted specimen.
- 10.5 Loading system - the contribution of the cell pressure to the vertical stress will be dependent on the loading system used. The calculation for deviator stress is for a rigid loading system. For a flexible loading system, a secondary force may be required throughout the duration of the test to ensure the loading ram is firmly in contact with the top loading cap. This secondary force should be taken into account when calculating the deviator stress.
- 10.6 Area correction - for specimens which suffer significant vertical and lateral deformation (that is >2%) (that is specimens prepared near OMC), an area correction (AS 1289.6.4.1) should be applied to accurately calculate the dry stresses applied to the specimen.

- 10.7 Specimen length - to determine the resilient strain, and hence the resilient modulus, in real time, the gauge length used for modulus determination at any cycle ( $n$ ), is the gauge length at the completion of the previous cycle ( $n - 1$ ).

**Table 1 – Dimensions and tolerances for RLT equipment**

Apparatus	Dimension	Tolerance
<b>Mould</b>		
Internal diameter (mm)	100	± 1
Height (mm)	200	± 2
<b>Levelling plate</b>		
Diameter (mm)	99	0, -1
Height (mm)	20	minimum

**Table 2 – Dimensions and tolerances for rammers**

Apparatus	Dimension	Tolerance
<b>Rammer – standard</b>		
Face diameter (mm)	50	± 0.4
Drop (mm)	300	± 2.0
Mass (g)	2700	± 10
<b>Rammer – modified</b>		
Face diameter (mm)	50	± 0.4
Drop (mm)	450	± 2.0
Mass (g)	4900	± 10

**Table 3 – Permanent strain limits**

Range (cycles)	Permanent strain (%)	Tolerance
1 to 1000	1.5	Maximum
1000 to 50,000	4.0	Maximum

Figure 1 – Schematic of typical repeated load triaxial test apparatus

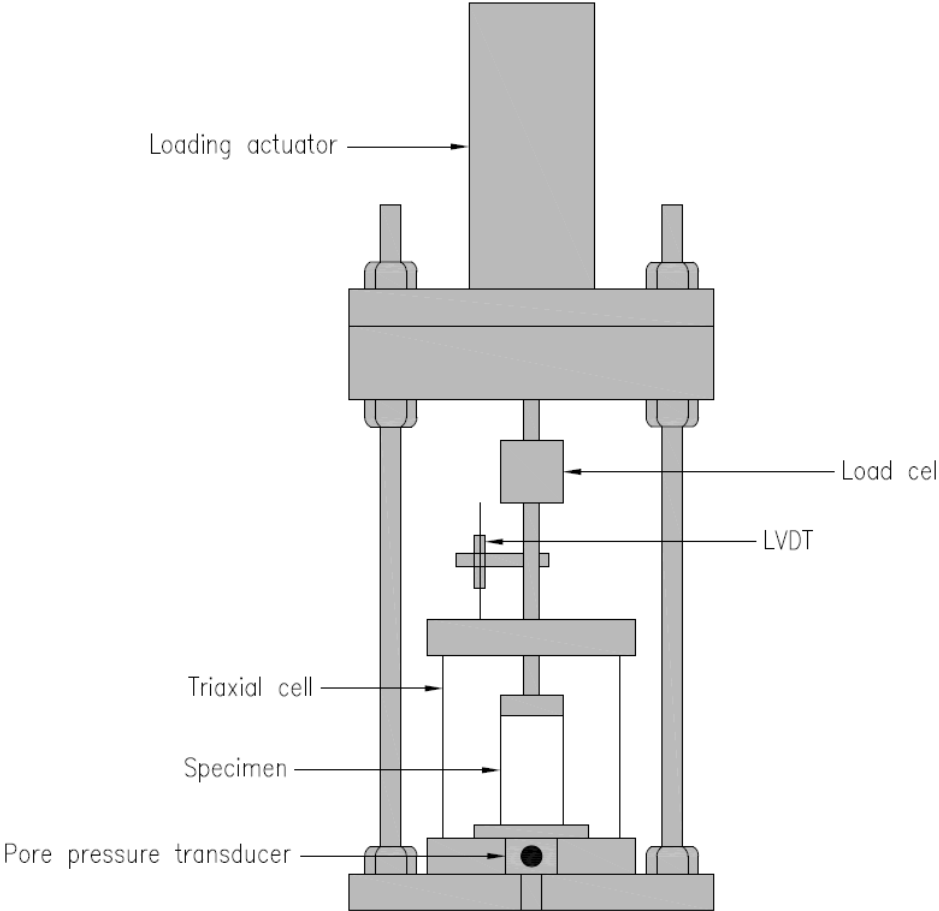
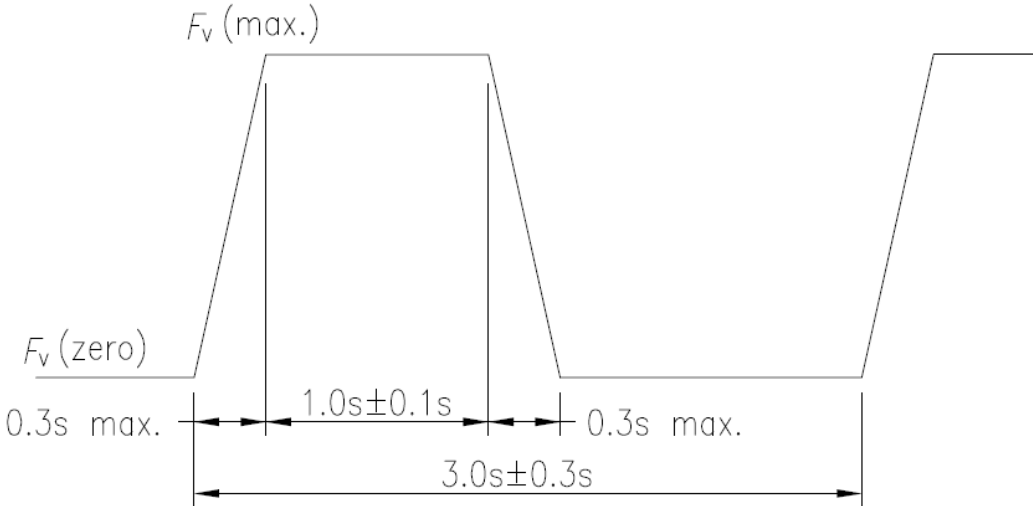
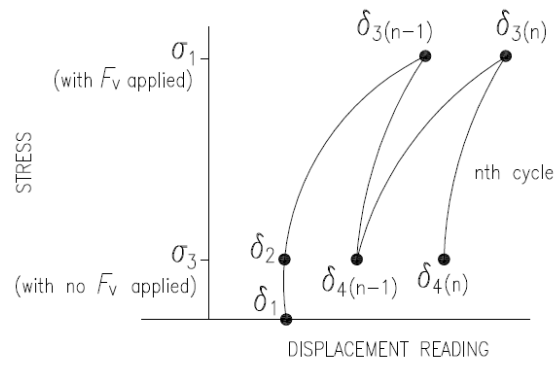

Figure 2 - Illustration of the vertical force waveform





**Figure 3 - Illustration of terms**



## Test Method Q138A: Preparation and compaction of laboratory mixed foamed bitumen stabilised material

### 1 Source

This Test Method was developed in house but utilises test specimen compaction based on Q305: *Stability, Flow and Stiffness of Asphalt* (Marshall) and applies it to the preparation and compaction of foamed bitumen stabilised materials.

### 2 Scope

This Test Method describes the procedure for laboratory preparation, mixing and compaction of foamed bitumen stabilised materials. The method has application as a laboratory design procedure. Test specimens are compacted using passing 37.5 mm material and the Marshall apparatus.

### 3 Apparatus

Where appropriate the working tolerances of apparatus are contained in Table 1.

The following apparatus is required:

#### 3.1 Compaction equipment:

Examples of the apparatus are shown in ASTM D5581 Figures 1 to 3

- a) Cylindrical steel compaction mould having an internal diameter of 152.4 mm, a height of 114.3 mm and a thickness of 6.35 mm; a mould base with a thickness of 12.7 mm and an extension collar having an internal diameter of 155.6 mm, a height of 82.6 mm and a thickness of 4.75 mm. The removable base is required to fit the compaction pedestal.
- b) Hand compaction hammer, consisting of a flat circular tamping face having a diameter of 149.4 mm, and a sliding weight with a mass of 10.21 kg and a free fall of 457.2 mm (Note 8.1).
- c) Compaction pedestal, consisting of the following:
  - i. a wooden block, of approximate dimensions 200 mm square and 450 mm thick, capped by a steel plate of approximate dimensions 300 mm square and 25 mm thick. With an air-dry density of 720 kg/m<sup>3</sup>. The plate securely attached to the block and secured to a solid concrete floor or slab. Suitable clamp ring for restraining the compaction mould and guides for locating the compaction hammer centrally during compaction may be attached to the block, or
  - ii. a concrete block, of approximate dimensions 360 mm square and 610 mm thick. Suitable clamp ring for restraining the compaction mould and guides for locating the compaction hammer centrally during compaction may be attached to the block, or
  - iii. a steel post (circular or square cross-section), of approximate dimensions 150 mm diameter / square and 620 mm thick. Suitable clamp ring for restraining the compaction mould and guides for locating the compaction hammer centrally during compaction may be attached to the block.
- d) Specimen extrusion jack, consisting of a hydraulic jack fitted with a plate on the ram and located within a metal frame. With, a plate 151.5 mm diameter and 12 mm thick for 150 mm diameter test specimens and a frame to retain the mould during extrusion of a test specimen.

- 3.2 Balance of suitable capacity, having a resolution of at least 0.1 g and with a limit of performance within the range of  $\pm 0.5$  g.
- 3.3 Sieves, 37.5 mm and 9.50 mm, conforming to ISO 3310.
- 3.4 Stopwatch with a resolution not exceeding 0.1 seconds.
- 3.5 Thermometer, a partial immersion thermometer or other suitable temperature measuring device having a temperature range of at least 150 C - 250°C and graduated to 1°C or less with an uncertainty of no more than 0.5°C.
- 3.6 Container(s) for storing manufactured material.

#### **4 Materials**

The following materials are required:

- 4.1 Filter paper (Whatman No. 1 or equivalent).

#### **5 Sample preparation**

The sample shall be prepared as follows:

- 5.1 Prepare the bulk sample in accordance with Section 4 of Test Method Q101 to produce a representative subsample of at least 80 kg.
- 5.2 Further prepare the material by screening the subsample on a 37.5 mm sieve in accordance with Test Method Q101, Steps 5.2.1 to 5.2.2. Ensure that any aggregations are broken up to pass a 9.5 mm sieve. Discard any material retained on the 37.5 mm sieve.
- 5.3 Prepare representative test portions of the sieved material in accordance with Test Method Q101, Steps 5.2.3 to 5.2.5 as follows:
  - a) minimum of two test portions of 13,000 g for foamed bitumen testing (Note 8.2)
  - b) test portion for hygroscopic moisture content, and
  - c) four or more test portions to determine the OMC and MDD.
- 5.4 Determine the mass of each test portion prepared in Step 5.3 a) ( $m_1$ ).
- 5.5 Determine the hygroscopic moisture content ( $w_1$ ) of the test portion prepared in Step 5.1.3 b) in accordance with Test Method AS 1289.2.1.1.
- 5.6 Determine the OMC and MDD using the test portions prepared in Step 5.3 c) in accordance with Test Methods Q142A or Q142B as appropriate. If all material passes the 19.0 mm test sieve in Step 5.2, use a Type A mould; otherwise, use the Type B mould.

#### **6 Production of test specimens**

The test specimens shall be produced as follows:

For each foamed bitumen test portion:

##### **6.1 Preparing mix**

- 6.1.1 Using the procedure in accordance with Test Method Q135A with nominated dry stabilising agent content ( $p_1$ ), calculate the dry mass of each test portion ( $m_2$ ) and mass of stabilising agent (lime or lime / flyash) ( $m_s$ ).

- 6.1.2 Using the procedure in accordance with Test Method Q254A with the optimum moisture content ( $w_o$ ), dry mass of each test portion ( $m_2$ ) and mass of stabilising agent (lime or lime / flyash) ( $m_s$ ), calculate the required quantities, prepare the foaming apparatus and produce foamed bitumen material.
- 6.1.3 Prepare a minimum of three test portions in accordance with Test Method Q101, Steps 5.2.1 to 5.2.3, of sufficient quantity to produce a specimen of 60-80 mm in height (Note 8.3).
- 6.1.4 Obtain a moisture sample from the mixture and determine the achieved moisture content ( $w_a$ ) in accordance with Test Method AS 1289.2.1.1.

## **6.2 Compaction**

- 6.2.1 Position a paper disc on the base plate within the assembled mould and collar.
- 6.2.2 Transfer the prepared material to the mould and level the surface taking care to avoid segregation.
- 6.2.3 Position another paper disc on the top surface of the material.
- 6.2.4 Transfer the compaction mould to the compaction pedestal and compact the mix using 50 blows of the compaction hammer with the hammer axis held vertically.
- 6.2.5 Remove the collar and base plate, then reassemble the compaction mould with the test specimen inverted and in contact with the base plate. Transfer the compaction mould to the compaction pedestal.
- 6.2.6 Apply a further 50 blows of the compaction hammer with the hammer axis held vertically.
- 6.2.7 Extrude the specimen from the mould using the specimen extrusion device and discard the filter papers.
- 6.2.8 Complete compaction within 75 minutes, timed from the completion of mixing (Test Method Q254A Step 6.2.6). Record the date and time of compaction.

## **7 Reporting**

The following shall be reported:

- 7.1 Identification of host material including:
  - a) Source and description of host of material
  - b) Sampling location, and
  - c) Date of sampling
- 7.2 Moisture / density relationship results:
  - a) MDD to the nearest 0.01 t/m<sup>3</sup>
  - b) OMC to the nearest 0.5%
- 7.3 Compaction results:
  - a) Achieved moisture content to the nearest 0.1%, and
- 7.4 The number of this Test Method, that is Q138A.

## 8 Notes on method

- 8.1 Where a mechanical compactor is used instead of the hand compactor, the mass, free fall and design of the hammer foot should be identical to those of the hand compaction hammer and the automatic compactor should be securely anchored to a base. Mechanical compactors will typically apply blows at a rate of about 50 blows / minute.
- 8.2 The combined test portion mass of 26 kg will be adequate for most materials. This is required to ensure the mixer has sufficient material to mix effectively and ensure the foamed bitumen can be incorporated with minimal loss.
- 8.3 A compaction portion mass of 2700 g will be adequate for most materials. All specimens should be essentially the same mass, a tolerance of  $\pm 2$  g has been found to be suitable.

**Table 1 - Dimensions and tolerances for compaction apparatus**

Apparatus	Dimension	Tolerance
<b>Mould</b>		
Internal diameter (mm)	152.40	$\pm 0.2$
<b>Hammer</b>		
Tamping face diameter (mm)	149.4	$\pm 0.1$
Sliding weight mass (kg)	10.21	$\pm 0.01$
Free fall (mm)	457.2	$\pm 2.5$

## Test Method Q138B: Preparation and compaction of field mixed foamed bitumen stabilised material

### 1 Source

This Test Method was developed in-house but uses test specimen compaction based on Test Method Q305: *Stability, Flow and Stiffness of Asphalt* (Marshall) and applies it to the preparation and compaction of foamed bitumen stabilised materials.

### 2 Scope

This Test Method describes the procedure for field preparation, mixing and compaction of foamed bitumen stabilised materials. The Test Method has application in preparing field mixed specimens to check field processes.

Test specimens are compacted using passing 37.5 mm material and the Marshall apparatus.

### 3 Apparatus

Where appropriate the working tolerances of apparatus are contained in Table 1.

The following apparatus is required:

#### 3.1 Compaction equipment

Examples of the apparatus are shown in ASTM D5581 Figures 1 to 3

- a) Cylindrical steel compaction mould having an internal diameter of 152.4 mm, a height of 114.3 mm and a thickness of 6.35 mm; a mould base with a thickness of 12.7 mm and an extension collar having an internal diameter of 155.6 mm, a height of 82.6 mm and a thickness of 4.75 mm. The removable base is required to fit the compaction pedestal.
- b) Hand compaction hammer, consisting of a flat circular tamping face having a diameter of 149.4 mm, and a sliding weight with a mass of 10.21 kg and a free fall of 457.2 mm (Note 8.1).
- c) Hand compaction pedestal, consisting of the following:
  - i. a wooden block, of approximate dimensions 200 mm square and 450 mm thick, capped by a steel plate of approximate dimensions 300 mm square and 25 mm thick, with an air-dry density of 720 kg/m<sup>3</sup>. The plate is securely attached to the block and secured to a solid concrete floor or slab. Suitable clamp ring for restraining the compaction mould and guides for locating the compaction hammer centrally during compaction may be attached to the block, or
  - ii. a concrete block, of approximate dimensions 360 mm square and 610 mm thick. Suitable clamp ring for restraining the compaction mould and guides for locating the compaction hammer centrally during compaction may be attached to the block, or
  - iii. a steel post (circular or square cross-section), of approximate dimensions 150 mm diameter / square and 620 mm thick. Suitable clamp ring for restraining the compaction mould and guides for locating the compaction hammer centrally during compaction may be attached to the block.

- d) Specimen extrusion jack, consisting of a hydraulic jack fitted with a plate on the ram and located within a metal frame with a plate 151.5 mm diameter and 12 mm thick for 150 mm diameter test specimens and a frame to retain the mould during extrusion of a test specimen.
- 3.2 Balance of suitable capacity, having a resolution of at least 0.1 g and with a limit of performance within the range of  $\pm 0.5$  g.
  - 3.3 Sieves, 37.5 mm and 9.50 mm, conforming to ISO 3310.
  - 3.4 Container(s) for storing and transporting the sampled material.

## 4 Materials

The following materials are required:

- 4.1 Potable water.
- 4.2 Filter paper (Whatman No. 1 or equivalent).

## 5 Sample preparation

The sample shall be prepared as follows:

- 5.1 Obtain a sample of the field-mixed material as soon as practicable after the completion of mixing using the sampling technique described Test Method Q061 Section 6. Seal the bulk sample in an airtight container for transport to the moulding location (Note 8.2).
- 5.2 Prepare the material by screening the sample on a 37.5 mm sieve in accordance with Test Method Q101, Steps 5.2.1 to 5.2.2. Ensure any moisture loss is minimised, and any aggregations are broken up to pass a 9.50 mm sieve. Discard the material retained in the 37.5 mm sieve and thoroughly remix the material passing the 37.5 mm sieve.
- 5.3 Prepare representative test portions of the sieved material in accordance with Test Method Q101, Steps 5.2.3 to 5.2.5 as follows:
  - a) compaction test portions of sufficient quantity to compact three specimens for insitu stabilised materials or nine specimens for plant mixed stabilised materials (Note 8.2), and
  - b) one test portion for achieved moisture content.
- 5.4 From each compaction test portion prepared in Step 5.3 a), prepare a minimum of three test portions in accordance with Test Method Q101, Steps 5.2.1 to 5.2.3, of sufficient quantity to produce a specimen of 60-80 mm in height (Note 8.3).
- 5.5 Determine the achieved moisture content ( $w_a$ ) using the test portion prepared in Step 5.3 b) in accordance with Test Method AS 1289.2.1.1.

## 6 Compaction

The sample shall be compacted as follows:

- 6.1.1 Position a paper disc on the base plate within the assembled mould and collar.
- 6.1.2 Transfer the prepared material from Step 5.4 to the mould and level the surface taking care to avoid segregation.
- 6.1.3 Position another paper disc on the top surface of the material.
- 6.1.4 Transfer the compaction mould to the compaction pedestal and compact the mix using 50 blows of the compaction hammer with the hammer axis held vertically.

- 6.1.5 Remove the collar and base plate, then reassemble the compaction mould with the test specimen inverted and in contact with the base plate. Transfer the compaction mould to the compaction pedestal.
- 6.1.6 Apply a further 50 blows of the compaction hammer with the hammer axis held vertically.
- 6.1.7 Extrude the sample from the mould using the specimen extrusion device and discard the filter papers.
- 6.1.8 Complete compaction within 75 minutes, timed from mixing (Step 5.1). Record the date and time of the completion of laboratory compaction.
- 6.1.9 Calculate the time elapsed between the start of mixing, in Step 5.1, and the completion of laboratory compaction.

## **7 Reporting**

The following shall be reported:

- 7.1 Mix details:
  - a) identification of host material including source of material
  - b) bitumen grade, source and target percentage added
  - c) foaming agent used and amount added
  - d) type of secondary binder used, source and percentage added
  - e) sampling location, and
  - f) date of sampling.
- 7.2 Date and time of mixing.
- 7.3 Date and time of compaction.
- 7.4 Achieved moisture content to the nearest 0.1%.
- 7.5 The elapsed time between mixing and the completion of laboratory compaction to the nearest 15 minutes (0.25 hours).

The number of this Test Method, that is Q138B.

## **8 Notes on method**

- 8.1 Where a mechanical compactor is used instead of the hand compactor, the mass, free fall and design of the hammer foot should be identical to those of the hand compaction hammer and the automatic compactor should be securely anchored to a base. Mechanical compactors will typically apply blows at a rate of about 50 blows / minute.
- 8.2 All samples should be essentially the same mass, a tolerance of  $\pm 2$  g has been found to be suitable.



**Table 1 – Dimensions and tolerances for compaction apparatus**

<b>Apparatus</b>	<b>Dimension</b>	<b>Tolerance</b>
<b>Mould</b>		
Internal diameter (mm)	152.40	± 0.2
<b>Hammer</b>		
Tamping face diameter (mm)	149.4	± 0.1
Sliding weight mass (kg)	10.21	± 0.01
Free fall (mm)	457.2	± 2.5

## Test Method Q139: Resilient modulus of stabilised material – indirect tensile method

### 1 Source

This Test Method was developed in-house but applies the principles of AS/NZS 2891.13.1 – *Determination of the resilient modulus of asphalt – Indirect tensile method to the testing of foamed bitumen stabilised materials*.

### 2 Scope

This Test Method describes the procedure for laboratory determination of the resilient modulus using repeat load indirect tensile techniques to determine foamed bitumen mix design properties.

The Test Method may be used to test both laboratory mixed and field mixed specimens prepared using Test Method Q138A and Q138B respectively. It may also be used to test cored specimens removed by dry coring using Test Method Q070.

### 3 Definition

For this Test Method, the following definition shall apply:

- 3.1 Resilient horizontal deformation – the difference between the peak horizontal deformation associated with a load pulse and the horizontal deformation at the end of the rest time of that load pulse.

### 4 Apparatus

Where appropriate the working tolerances of apparatus are contained in Table 1.

The following apparatus is required:

- 4.1 Testing machine, a pneumatic or hydraulic testing machine that is capable applying the following:
- Approximately triangular shaped or haversine load pulse with a rise time (defined as the time required for the load pulse to rise from 10% to 90% of the peak force) in the range of 0.025 to 0.1 seconds with an accuracy of  $\pm 0.005$  seconds.
  - Load pulses with peak load adjustable over the range 0.4 kN to 3.9 kN with an accuracy of  $\pm 0.05$  kN. With an adjustable pulse repetition period over the range 0.5 seconds to 10 seconds  $\pm 0.005$  s (Refer to AS/NZS 2891.13.1 Figure 1 for pulse shapes) and applying this load pulse for at least 10 cycles for each specimen.
- 4.2 Temperature cabinet, a temperature-controlled cabinet that is capable of the following:
- holding the loading frame, at least three test specimens and a dummy specimen and with sufficient internal space to permit adjustment of the frame, displacement measuring devices and specimens
  - maintaining a temperature of  $25^{\circ}\text{C} \pm 0.5^{\circ}\text{C}$  and fitted with an external device that indicates the temperature inside the cabinet.

- 4.3 Measuring and recording apparatus, consisting of:
- a) Load-measuring device of at least 3.9 kN capacity, conforming to the requirements of an AS 2193 Class B testing machine when calibrated statically.
  - b) Displacement measuring device conforming to the requirements of an AS 1545 Grade B extensometer for gauge lengths equal to the diameter of the specimen, with a range of at least 100 µm for measurement of horizontal displacements for each pulse and capable of being held in contact with the specimen during the complete test. With the device anchored to the specimen through 114" UNF bolts to which a torque of approximately 250 mN.m is applied.
  - c) Recorder able to read and record the individual measurements of load, temperature and the peak horizontal deformation after application of a pulse and the horizontal deformation at the end of the pulse.
- 4.4 Plano-cylindrical-concave steel loading blocks, 125 mm long blocks that are flat on the loading surface and curved on the surface in contact with the specimen. With the thickness of the blocks, measured at the thinnest section, between the concave surface and the flat surface on the other side not less than 18 mm. The width of the loading blocks as measured from tip to tip of the concave face, and the radius of curvature are shown in Table 1. There will be a hole at each end of the blocks to accommodate the locating bolts.
- 4.5 Calliper, with a resolution not greater than 0.1 mm conforming to the requirements of ISO 13385-1 or JIS B 7507.
- 4.6 Temperature measuring devices, readable to 0.1°C with an uncertainty not greater than 0.2°C at the required test temperature.
- 4.7 Torque screwdriver, conforming to ISO 6789, with minimum range 0.1 N m to 1 N m and readable to 10 mN m.

## **5 Specimen preparation and curing**

### **5.1 Laboratory mixed specimens**

For laboratory mixed materials, the procedure shall be as follows:

- 5.1.1 Prepare the material in accordance with Test Method Q138A to obtain six specimens (Note 9.1) for testing for initial modulus, three day cured modulus and three day, soaked modulus.
- 5.1.2 Following extrusion of the specimens from the compaction moulds, perform the initial curing of three specimens in accordance with Test Method Q254B Step 5.1.
- 5.1.3 After the initial curing, measure and test the specimens in accordance with Steps 6.1 to 6.5 to determine the initial / as received modulus, then discard these specimens once the initial modulus testing is complete.
- 5.1.4 Following extrusion of the specimens from the compaction moulds, perform the oven curing of the remaining three specimens in accordance with Test Method Q254B Step 5.2.
- 5.1.5 After the oven curing, measure and test the specimens at  $72 \pm 1.0$  hours from completion of compaction in accordance with Steps 6.1 to 6.5 to determine the cured modulus.
- 5.1.6 Following the three day modulus testing, perform the vacuum soaking of the specimens in accordance with Test Method Q254B Step 5.3.

- 5.1.7 After the vacuum soaking, test the specimens in accordance with Steps 6.1.5 to 6.5 to determine the soaked modulus.

## **5.2 Field mixed specimens (from insitu stabilisation)**

For field mixed materials sampled from an insitu stabilising process the procedure shall be as follows:

- 5.2.1 Prepare the material in accordance with Test Method Q138B to obtain three specimens (Note 9.1) for testing for three day cured modulus and three day soaked modulus.
- 5.2.2 Perform the curing and testing as in Steps 5.1.4 to 5.1.7 with the specimens tested at  $72 \pm 1.0$  hours from completion of compaction.

## **5.3 Field mixed specimens (from plant mixed stabilisation)**

For field mixed materials sampled from a plant mixed stabilising process the procedure shall be as follows:

- 5.3.1 Prepare the material in accordance with Test Method Q138B to obtain nine specimens (Note 9.1) for testing.
- 5.3.2 Use three specimens for testing three day cured modulus and three day, soaked modulus. Perform the curing and testing as in Steps 5.1.4 to 5.1.7 with the specimens tested at  $72 \pm 1.0$  hours from completion of compaction.
- 5.3.3 Use three specimens for testing seven day cured modulus and seven day, soaked modulus. Perform the curing and testing as in Steps 5.1.4 to 5.1.7 with the specimens tested at  $168 \pm 1.0$  hours from completion of compaction.
- 5.3.4 Use three specimens for testing fourteen day cured modulus and fourteen day, soaked modulus. Perform the curing and testing as in Steps 5.1.4 to 5.1.7 with the specimens tested at  $336 \pm 1.0$  hours from completion of compaction.

## **5.4 Core specimens**

- 5.4.1 Obtain at least three core samples about 150 mm diameter from the pavement in accordance with Test Method Q070.
- 5.4.2 Prepare the core sample in accordance with Test Method Q070 Section 7 to obtain three specimens between 60.0 to 80.0 mm in height for testing for as received modulus and soaked modulus.
- 5.4.3 Perform the curing and testing as in Steps 5.1.2 to 5.1.3 and 5.1.6 to 5.1.7.

## **6 Testing of specimens**

The specimens shall be measured and tested as follows:

### **6.1 Initial measurements and specimen setup**

- 6.1.1 The specimen shall be cylindrical with smooth and uniform curved surfaces. The top and bottom faces shall be smooth and not depart from squareness to the axis by more than  $3^\circ$  (about 7.5 mm in 150 mm).
- 6.1.2 Mark two diameter lines at right angles to each other on one end of the specimen and a corresponding pair on the opposite end of the specimen.
- 6.1.3 Measure the two marked diameters of the specimen at each end of the specimen ( $d_i$ ). Calculate the mean diameter of the specimen (D).

- 6.1.4 Measure the height of the specimen at each of the four marked locations where the diameter markings intersect the circumference ( $h_i$ ). Calculate the mean height of the specimen ( $h_c$ ).
- 6.1.5 Place the first specimen in the loading apparatus, ensuring that the diametral markings are vertical and horizontal.
- 6.1.6 Place the displacement measuring apparatus on the specimen along the horizontal diametral marking to measure the horizontal deformation of the curved surfaces. Ensure the displacement measuring devices sit centrally and diametrically opposite each other on the specimen.
- 6.1.7 Anchor the apparatus on the flat surfaces of the specimen with a clamping torque of approximately 250 mN m applied to each anchoring bolt.
- 6.1.8 Place the top loading block onto the specimen ensuring it sits centrally and is in line with the vertical diametric line.
- 6.1.9 Place the whole apparatus under the loading head. Check the load actuator ram is adjusted close to its mid-stroke and the specimen is secure and sitting centrally between the loading blocks. Lower the load actuator ram onto the top loading block. The load actuator ram is generally adjusted to within 20% of its mid-stroke point in accordance with the relevant manufacturer's instructions.
- 6.1.10 Adjust each displacement measuring device so that it is in the central position of its travel range and the lower the frame holder so there is no contact between the supporting frame for each displacement measuring device and the frame holder (Note 9.2).
- 6.1.11 Check each displacement measuring device is still in a central position of its travel range and adjust if necessary.

## **6.2 Standard test conditions – laboratory mixed and field mixed specimens**

- 6.2.1 Unless otherwise specified, use the following standard test conditions:
  - a) test temperature:  $25^{\circ}\text{C} \pm 0.5^{\circ}\text{C}$
  - b) rise time (10% to 90%):  $0.04 \pm 0.005$  seconds
  - c) pulse repetition period (10% to 10%):  $3.0 \pm 0.005$  seconds, and
  - d) recovered horizontal strain:  $50 \pm 20$   $\mu\epsilon$ .

## **6.3 Standard test conditions – cored specimens**

- 6.3.1 Unless otherwise specified, use the following standard test conditions:
  - a) test temperature:  $25^{\circ}\text{C} \pm 0.5^{\circ}\text{C}$
  - b) rise time (10% to 90%):  $0.04 \pm 0.005$  seconds
  - c) pulse repetition period (10% to 10%):  $3.0 \pm 0.005$  seconds, and
  - d) recovered horizontal strain:  $20 \pm 5$   $\mu\epsilon$ .

## 6.4 Preconditioning and test setting determination

- 6.4.1 The test shall be performed within the range of the specified recovered horizontal strain. Calculate the peak load required to deform the specimen within that range as follows (Note 9.3):

$$P_e = \frac{ED\varepsilon h_c}{(v + 0.27)10^6}$$

where	$P_e$	=	peak estimated load (N)
	$E$	=	estimated resilient modulus of the specimen (MPa)
	$D$	=	mean diameter of the specimen (mm)
	$\varepsilon$	=	recovered horizontal strain ( $\mu\varepsilon$ ), usually $50 \pm 20 \mu\varepsilon$
	$h_c$	=	mean height of the specimen (mm)
	$v$	=	Poisson ratio (estimated as 0.4)

- 6.4.2 Ensure that the temperature of the specimen has reached equilibrium after attaching the displacement apparatus. A dummy specimen may be used to verify the specimen has reached an equilibrium temperature.
- 6.4.3 Apply a single pulse with the specified rise time to the estimated peak load calculated above, then remove the load. Measure the recovered horizontal deformation at the end of the pulse and calculate the recovered horizontal strain as follows:

$$\varepsilon = \frac{H}{D}$$

where	$\varepsilon$	=	recovered horizontal strain ( $\varepsilon$ )
	$H$	=	recovered horizontal deformation (mm)
	$D$	=	mean diameter of the specimen (mm)

This process of measurement and adjustment in Steps 6.4.3 to 6.4.5 of the load to target the recovered horizontal strain may be automated on some test machines (Note 9.4).

- 6.4.4 If the recovered horizontal strain is within the specified range, continue to apply further preconditioning pulses, adjusting the estimated peak load so that the recovered horizontal strain approaches the mid-point of the specified range until five pulses of preconditioning have been completed (Note 9.4).
- 6.4.5 If the recovered horizontal strain is not within the specified range, adjust the estimated peak load so that the recovered horizontal strain will fall within the specified range, repeating the process from Step 6.4.3.
- 6.4.6 Repeat Step 6.4.3 to 6.4.5 until the specified range is obtained. Record the peak load and the recovered horizontal strain for each pulse (Note 9.4).
- 6.4.7 If the specified range of recovered strain is not achieved after five pulses, the resilient modulus test is terminated for the specimen.

## 6.5 Resilient modulus test

Resilient modulus shall be determined by testing three specimens. For each specimen, the procedure shall be as follows:

- 6.5.1 Apply five load pulses with the specified rise time to the peak load determined from Sub-section 6.4 at the specified pulse repetition period.
- 6.5.2 Measure and record the recovered horizontal deformation and load after each pulse. Determine the peak load ( $P$ ) and recovered horizontal deformation ( $H$ ) for the peak load.

## 7 Calculations

Calculations shall be as follows:

- 7.1 Calculate the initial modulus ( $M_I$ ), cured modulus ( $M_C$ ), soaked modulus ( $M_S$ ) and as received modulus ( $M_{AR}$ ) as follows (Note 9.6):

$$M = P \frac{(v + 0.27)}{Hh_c}$$

- where
- |       |   |   |
|-------|---|---|
| $M$   | = | resilient modulus (initial, three day cured, three day soaked, seven day cured, seven day soaked, fourteen day cured, fourteen day soaked, as received) (MPa) |
| $P$   | = | peak load (N)   |
| $v$   | = | Poisson ratio (estimated as 0.4)  |
| $H$   | = | recovered horizontal deformation (mm)   |
| $h_c$ | = | mean height of the specimen (mm)  |

- 7.2 Calculate the retained modulus as follows (Note 9.5):

$$M_R = \frac{100M_S}{M_C}$$

- where
- |       |   |   |
|-------|---|---|
| $M_R$ | = | retained modulus (three day, seven day, fourteen day) (%) |
| $M_S$ | = | soaked modulus (MPa)                                      |
| $M_C$ | = | cured modulus (MPa)                                       |

Calculate the mean initial modulus, three day cured modulus, three day soaked modulus, seven day cured modulus, seven day soaked modulus, fourteen day cured modulus, fourteen day soaked modulus, as received modulus and retained modulus as appropriate.

## 8 Reporting

The following shall be reported:

- 8.1 Description of specimens, that is cores, field mixed specimens (from insitu mixed stabilisation or plant mixed stabilisation), laboratory mixed specimens.
- 8.2 Description of test conditions, that is, test temperature, rise time, pulse repetition period and recovered horizontal strain and any variations to the standard conditions.
- 8.3 Test temperature to the nearest 1°C.
- 8.4 Mean height of each specimen to the nearest 0.1 mm.
- 8.5 Mean diameter of each specimen to the nearest 0.1 mm.

- 8.6 For laboratory mixed specimens:
- a) Resilient modulus for each specimen and a mean of all specimens as follows:
    - i. initial modulus, three day cured modulus and three day soaked modulus to the nearest 1 MPa for each specimen and 50 MPa for mean
    - ii. three day retained modulus to the nearest 1% for each specimen and 2% for mean.
- 8.7 For field mixed specimens from insitu stabilisation:
- a) Resilient modulus for each specimen and a mean of all specimens as follows:
    - i. three day cured modulus and three day, soaked modulus to the nearest 1 MPa for each specimen and 50 MPa for mean
    - ii. three day retained modulus to the nearest 1% for each specimen and 2% for mean.
- 8.7.1 For field mixed specimens from plant mixed stabilisation:
- a) Resilient modulus for each specimen and a mean of all specimens as follows:
    - i. three day cured modulus, three day, soaked modulus, seven day cured modulus, seven day, soaked modulus, fourteen day cured modulus and fourteen day, soaked modulus to the nearest 1 MPa for each specimen and 50 MPa for mean
    - ii. three day retained modulus, seven day retained modulus and fourteen day retained modulus to the nearest 1% for each specimen and 2% for mean.
- 8.8 For core specimens:
- a) Resilient modulus for each specimen and a mean of all specimens as follows:
    - i. as received modulus and soaked modulus to the nearest 1 MPa for each specimen and 50 MPa for mean.
- 8.9 The number of this Test Method, that is Q139.

## 9 Notes on method

- 9.1 Additional specimens may be required to allow replacement of specimens damaged during the preconditioning and test setting determination.
- 9.2 Ensure the contact tips of the measuring device are secure and have a good sound contact with the surface of the specimen. Failure to do this may result in erratic strain readings.
- 9.3 This step is not required where the apparatus is fitted with a computer and software control capable of automatically applying conditioning pulses to calculate and adjust the peak load required. Usually only an estimated resilient modulus for the material is required for input into the software. Care should be taken to use an estimated modulus for the material to prevent damage to the specimen from overloading on the initial loading pulses.
- 9.4 For laboratory mixed and field mixed specimens the recovered horizontal strain should be within  $50 \pm 5 \mu\epsilon$  at the completion of the five preconditioning pulses. For cored specimens the recovered horizontal strain should be within  $20 \pm 2 \mu\epsilon$  at the completion of the five preconditioning pulses.
- 9.5 Where the apparatus is fitted with a computer and software control capable of automatically applying conditioning pulses and to calculate and adjust the peak load to achieve recovered horizontal strain, Steps 6.4.3 to 6.4.6 will be performed automatically by the apparatus.



9.6 Recommended minimum values may be obtained from the Transport and Main Roads, *Pavement Rehabilitation Manual*.

**Table 1 – Test equipment requirements**

<b>Apparatus</b>	<b>Requirement</b>	<b>Tolerance</b>
<b>Loading blocks (150 mm dia. specimen)</b>		
Width (mm)	19.0	± 2.0
Radius of curvature of concave face (mm)	75.0	± 2.0

## Test Method Q140A: Relative compaction of soils and crushed rock

### 1 Source

This Test Method applies the principles of AS 1289.5.4.1: *Soil compaction and density tests – Dry density ratio, moisture variation and moisture ratio*. It differs from this standard by the additional determination of MDD and OMC on uncompacted material.

### 2 Scope

This Test Method sets out the procedure for the determination of the relative compaction of soil and crushed rock materials, including mixtures containing stabilising agent, having not more than 20% of oversize rock material retained on the 37.5 mm sieve.

Where oversize is present in the soil or crushed rock, adjust the MDD and OMC for this oversize component. Base the adjustment to the MDD and OMC upon the oversize content from the oversize within the laboratory sample(s) used to determine the MDD and OMC.

### 3 Definitions

For this Test Method, the following definitions shall apply:

- 3.1 Relative compaction (dry density ratio) - ratio of compacted dry density to adjusted MDD expressed as a percentage.
- 3.2 Relative moisture content - ratio of insitu moisture content to the adjusted OMC expressed as a percentage.

Allowable working time - the time measured from the commencement of incorporation (that is, mixing) of stabilising agent into the material to completion of compaction and trimming.

### 4 Procedure

The procedure shall be as follows:

#### 4.1 MDD and OMC using assigned values

Assign or use previously assigned values of MDD, OMC in accordance with Step 4.1.1 or 4.1.2.

Where assigned values are either not appropriate or are impractical, sample and test for MDD, OMC in accordance with Subsection 4.2.

##### 4.1.1 New assigned values

Obtain samples of uncompacted material and if necessary, stabilising agents and assign values of MDD and OMC in accordance with Test Method Q144A.

##### 4.1.2 Previously assigned values

Confirm and monitor the applicability of previously assigned values using the Assigned Values Check procedure in accordance with Test Method Q144A.

#### 4.2 MDD and OMC using one-for-one testing

- 4.2.1 Use random stratified sampling to determine sampling and test locations in accordance with the requirements of the specification, sampling plan or testing methodology as appropriate.

4.2.2 Obtain samples in accordance with Test Method Q061 and test for MDD, OMC, volume, mass and percentage of oversize as follows:

- a) For pavement materials including granular stabilisation and excluding stabilised materials with a stabilising agent:
  - i. obtain samples of compacted material following the field testing operations for the compacted density test (refer to Subsection 4.3). Use the sampling technique described Test Method Q061 Section 5: *Sampling from Compacted layer of earthworks or pavement*
  - ii. determine the MDD, OMC, volume, mass and percentage of oversize for each sample in accordance with Test Method Q142A or Q142B as appropriate.
- b) Stabilised materials excluding granular stabilisation:
  - i. obtain samples of uncompacted material after spreading and the incorporation of all stabilising agents and water, but before the start of compaction. Use the sampling technique described Test Method Q061 Section 6: *Sampling from uncompacted layer of earthworks or pavement*
  - ii. determine the MDD, OMC, volume, mass and percentage of oversize for each sample in accordance with Test Method Q142A or Q142B as appropriate
  - iii. complete the process of obtaining the sample, preparation and compaction of the test portions within the allowable working time for the stabilising agent (Note 7.1). Record the time elapsed between the start of mixing and completion of compaction
  - iv. determine the insitu moisture content ( $w_f$ ) for each sample, including oversize material, in accordance with Test Method AS 1289.2.1.1 or one of the subsidiary Test Methods AS 1289.2.1.2, AS 1289.2.1.4, AS 1289.2.1.5 or AS 1289.2.1.6 for which a relationship with Test Method AS 1289.2.1.1 has been established and used in accordance with Test Method AS 1289.2.3.1, and
  - v. moisture content samples must be returned to a laboratory and placed in drying ovens within the same work shift as the stabilisation works for the corresponding lot.

### 4.3 Compacted density

4.3.1 Use random stratified sampling to determine test locations in accordance with the requirements of the specification, sampling plan or testing methodology as appropriate. Use the locations determined in Step 4.2 when performing one-for-one testing.

4.3.2 At each of the test locations, determine the insitu moisture content and/or compacted dry density in accordance with Test Method Q141A or Q141B as appropriate. For stabilised materials, complete work to determine the wet density to a stage where the wet density has been determined within 24 hours after the end of the work shift where stabilisation works were completed for the corresponding lot. Additionally, return moisture content samples to a laboratory and place in drying ovens within the same work shift as the moisture content sampling is undertaken.

## 5 Calculations

Calculations shall be as follows:

- 5.1 For MDD and OMC using one-for-one testing, adjust the MDD for oversize material as follows:

$$\rho_f = \frac{100}{\frac{100 - P_{od}}{\rho_{dm}} + \frac{P_{od}V_o}{m_{od}}}$$

where  $\rho_f$  = adjusted MDD (t/m<sup>3</sup>)  
 $P_{od}$  = percentage of oversize (dry basis)  
 $\rho_{dm}$  = MDD (t/m<sup>3</sup>)  
 $V_o$  = volume of oversize (cm<sup>3</sup>)  
 $m_{od}$  = dry mass of oversize (g)

- 5.2 For MDD and OMC using one-for-one testing, adjust the OMC for oversize material as follows:

$$w_r = w_o \frac{100 - P_{od}}{100}$$

where  $w_r$  = adjusted OMC (%)  
 $w_o$  = OMC (%)  
 $P_{od}$  = percentage of oversize (dry basis)

- 5.3 Where there is no oversize present in the material  $\rho_f = \rho_{dm}$  and  $w_r = w_o$ .

- 5.4 Determine the relative compaction as follows:

$$RC_d = \frac{100\rho_d}{\rho_r}$$

where  $RC_d$  = relative compaction (dry density ratio) (%)  
 $\rho_d$  = compacted dry density (t/m<sup>3</sup>)  
 $\rho_r$  = adjusted MDD (t/m<sup>3</sup>)

- 5.5 Determine the relative moisture content as follows:

$$RM_d = \frac{100w_f}{w_r}$$

where  $RM_d$  = relative moisture content (%)  
 $w_f$  = insitu moisture content (%)  
 $w_r$  = Adjusted OMC (%)

- 5.6 Determine the moisture ratio (uncompacted), for stabilised materials, in accordance with Test Method Q250.

- 5.7 If required, where tests have been performed on a lot, calculate the maximum characteristic relative compaction in accordance with Test Method Q020.

- 5.8 If required, where tests have been performed on a lot, calculate the minimum characteristic relative compaction in accordance with Test Method Q020.

## **6 Reporting**

The following shall be reported:

### 6.1 Compaction results:

- a) Relative compaction to the nearest 0.5%
- b) Relative moisture content to the nearest 2%

### 6.2 MDD and OMC

#### 6.2.1 Using assigned values

- a) Adjusted MDD to the nearest 0.01 t/m<sup>3</sup>
- b) Adjusted OMC to the nearest 0.5%
- c) MDD and OMC were assigned
- d) Date when the MDD / OMC was assigned

#### 6.2.2 Using one-for-one testing

- a) Adjusted MDD to the nearest 0.01 t/m<sup>3</sup>
- b) Adjusted OMC to the nearest 0.5%
- c) Percentage of oversize to the nearest 1%
- d) The sieve on which the oversize material is retained (19.0 mm or 37.5 mm)
- e) Test Method used to determine percentage oversize, that is, Q143
- f) Date when the MDD / OMC was or determined

### 6.3 For material with a stabilising agent incorporated insitu:

- a) The elapsed time between addition of stabilising agent (mixing) and the completion of laboratory compaction to the nearest 15 minutes (0.25 hours)
- b) Source and description of the host material
- c) Source, type, ATIC Registration number of the stabilising agent(s)
- d) Stabilising agent(s) content(s) (%)
- e) Admixture content (%) or Admixture volume (mL/100 kg of stabilising agent)
- f) Moisture ratio (uncompacted) to the nearest 2%

### 6.4 When characteristics values are required:

- a) The minimum characteristic relative compaction in accordance with Test Method Q020, and/or
- b) The maximum characteristic relative compaction in accordance with Test Method Q020.

### 6.5 The number of this Test Method, that is Q140A.

## **7 Notes on method**

### 7.1 Working times will be specified in the relevant Technical Specification or Annexure to the Specification.

### **Test Method Q141A: Compacted density of soils - nuclear gauge**

This test shall be performed in accordance with Test Method N01: *Compacted density of soil - nuclear gauge* contained within the Department of Transport and Main Roads' *Nuclear Gauge Testing Manual*.

## Test Method Q141B: Compacted density of soils and crushed rock – sand replacement

### 1 Source

This Test Method is based on AS 1289.5.3.1: *Soil compaction and density tests - Determination of the field density of a soil - Sand replacement method using a sand-cone pouring apparatus*. It differs from this standard in the coarseness of material at which the larger template diameter is used, the range of materials tested by the method, maximum test-hole depth and calibration cylinder requirements.

### 2 Scope

The Test Method sets out the procedure for determining the compacted wet density and, when required, the compacted dry density of fine-grained, medium-grained and coarse-grained soils and crushed rock, including mixtures containing stabilising agent, by the sand replacement method using a sand-cone pouring apparatus.

The compacted dry density for the total material of the test site is determined from measured values of compacted wet density and in situ moisture content.

### 3 Apparatus

Examples of sand-cone pouring apparatus, wind-shield sand-cone pouring apparatus, template (tray) and calibration cylinder are contained in AS 1289.5.3.1, Figures 1, 2, 3 and 4.

Where appropriate, the working tolerances of apparatus are contained in Table 1.

The following apparatus is required:

- 3.1 Sand-cone pouring apparatus: either a sand-cone or a wind-shielded sand-cone comprised of a conical funnel, tap and cone with the cone being either 150 mm or 200 mm in diameter.
- 3.2 Template, a circular or square flat rigid metal template with raised sides and a central hole, either 150 mm or 200 mm in diameter, surrounded by a border at least 50 mm wide with at least two holes for pins to secure the template.
- 3.3 Pins, two or more metal pins with a length and diameter that allows securing of the template to the surface under test.
- 3.4 Excavation equipment - hand tools such as scoop, spoon, brush, trowel, chisel and mallet. A lightweight electric hammer can be used in place of or in conjunction with a chisel and mallet.
- 3.5 Calibration cylinder, a metal cylinder with the same diameter as the central hole in the template. The depth of the calibration cylinder needs to align with the excavated depth of hole to within 50 mm. The minimum depth of an acceptable calibration cylinder is 40 mm.
- 3.6 Balance of suitable capacity, having a resolution of at least 1 g and with a limit of performance within the range of  $\pm 5$  g.
- 3.7 Flat plate, approximately 300 mm square.
- 3.8 Soil containers, sealable containers of appropriate capacity.
- 3.9 Sand containers, translucent sealable containers of appropriate capacity.
- 3.10 Rule, a 300 mm long rule will service most requirements, with a 450 mm long rule required when test hole depth exceeds 300 mm.

## 4 Materials

The following materials are required:

- 4.1 Density sand, clean dry one-size sand with particles approximately uniform in size, for example, 90% passing a 1.18 mm test sieve and 90% retained on a 0.600 mm test sieve (Note 11.1).
- 4.2 Modelling plasticine or other suitable material (if required).

## 5 Test-hole and significant apparatus requirements

To determine the dimensions of the test-hole to be excavated in the lot under test and the appropriate sizes of the template, sand-cone pouring apparatus and calibration cylinder, it is necessary to consider the following:

- specification requirements and/or the depth of the layer
  - apparatus limitations, and
  - maximum particle size of the soil within the lot.
- 5.1 Determine the depth to be tested from the appropriate specification or testing methodology. Where the depth is not specified, test to the full depth of the layer up to a maximum test depth of 350 mm (Note 11.2). Refer to Table 1.
  - 5.2 Determine the test-hole diameter and template size based on the particle size of the soil within the lot and the test-hole depth by referring to Table 1.
  - 5.3 Select a matched template and sand-cone pouring apparatus set. Having the same diameter as the test-hole diameter and template size determined in Step 5.2.
  - 5.4 Select a calibration cylinder having the same diameter as the template hole and a depth that is within 50 mm of the depth of the test-hole.

## 6 Calibration of apparatus

Calibration of the sand-cone pouring apparatus and template set as well as determination of the sand pouring density for the batch of density sand shall be performed as follows:

### 6.1 Density sand sampling

Sample the batch of density sand by taking at least three representative samples randomly throughout the batch or one sample per 500 kg, whichever yields the greater number of samples. Record the batch identification details.

### 6.2 Mass of sand in the cone and template

- 6.2.1 Obtain a subsample from one of the representative density sand samples sufficient to fill the central hole in the template, the inverted cone and tap of the sand-cone pouring apparatus plus a small quantity which will remain in the funnel after pouring.
- 6.2.2 Transfer the sand to a sand container and determine the mass of the sand and the container ( $m_1$ ).
- 6.2.3 Place the template on the flat plate and position the sand-cone pouring apparatus and sand centrally over the hole in the template.



- 6.2.4 Open the tap on the sand-cone pouring apparatus and allow the sand to run. When no further movement of sand takes place, close the tap. Take care that the apparatus is not disturbed or vibrated while the tap is open. There needs to be sand still remaining in the funnel after pouring. Remove the sand-cone pouring apparatus and return the surplus sand in the tap and funnel to the container.
- 6.2.5 Determine the mass of the residual sand and the container ( $m_2$ ).
- 6.2.6 Repeat Steps 6.2.1 to 6.2.5 for each of the remaining representative samples of density sand using the same initial total mass of sand and container each time.
- 6.2.7 Calculate the mass of sand in the cone and template for each of the determinations as follows:

$$m_3 = m_1 - m_2$$

- where  $m_3$  = mass of sand in the cone and template (g)  
 $m_1$  = initial total mass of sand and container (g)  
 $m_2$  = mass of residual sand and container (g)

- 6.2.8 Calculate the mean mass of sand in the cone and template ( $\bar{m}_3$ ).

### 6.3 Sand pouring density

- 6.3.1 Obtain a subsample from one of the representative density sand samples which is sufficient to fill the calibrating cylinder, central hole in the template, the inverted cone and tap of the sand-cone pouring apparatus plus a small quantity which will remain in the funnel after pouring.
- 6.3.2 Transfer the sand to a sand container and determine the mass of the sand and the container ( $m_4$ ).
- 6.3.3 Place the template over the calibration cylinder such that the two holes are concentric. Position the sand-cone pouring apparatus and sand centrally over the hole in the template.
- 6.3.4 Open the tap on the sand-cone pouring apparatus and allow the sand to run. When no further movement of sand takes place, close the tap. Take care that the apparatus is not disturbed or vibrated while the tap is open. There needs to be sand still remaining in the funnel after pouring (Note 11.3). Remove the sand-cone pouring apparatus and return the sand in the tap and funnel to the container.
- 6.3.5 Determine the mass of the residual sand and the container ( $m_5$ ).
- 6.3.6 Repeat Steps 6.3.1 to 6.3.5 for each of the remaining representative samples of density sand using the same initial total mass of sand and container each time.
- 6.3.7 Calculate the pouring density of the sand for each of the determinations as follows:

$$\rho_{sand} = \frac{(m_4 - m_5) - \bar{m}_3}{V}$$

- where  $\rho_{sand}$  = sand pouring density (t/m<sup>3</sup>)  
 $m_4$  = initial mass of sand and container (g)  
 $m_5$  = mass of residual sand and container (g)  
 $\bar{m}_3$  = mean mass of sand in the cone and template (g)  
 $V$  = internal volume of calibration cylinder (cm<sup>3</sup>)

- 6.3.8 If the maximum variation in sand pouring densities for the batch of sand does not exceed 0.020 t/m<sup>3</sup>, calculate the mean sand pouring density ( $\bar{\rho}_{sand}$ ) and record to the nearest 0.001 t/m<sup>3</sup>.

## 7 Test site preparation

The test site shall be prepared as follows:

- 7.1 At the designated test location, use the template to define a test site which is flat and free from large depressions such as roller marks. For earthworks, it may be necessary to trim the surface flat.
- 7.2 Sweep all loose material from the test site and place the template on the prepared test site. If the surface is so irregular that the sand is likely to escape under the template, fill the irregularities under the tray with modelling plasticine or other suitable material to prevent sand escaping.
- 7.3 Mark the location of the template on the test site.

## 8 Testing

Testing at the prepared test site shall be performed as follows:

### 8.1 Surface correction

- 8.1.1 Fill a sand container with sufficient sand to fill the surface irregularities, the central hole in the template, cone and tap of the sand-cone pouring apparatus plus a quantity which will remain in the funnel after pouring.
- 8.1.2 Determine the mass of sand and the container ( $m_7$ ).
- 8.1.3 Place the sand-cone pouring apparatus and sand centrally over the hole in the template.
- 8.1.4 Open the tap on the sand-cone pouring apparatus and allow the sand to run. When no further movement takes place, close the tap. Take care that the apparatus is not disturbed or vibrated while the tap is open. There needs to be sand still remaining in the funnel after pouring.
- 8.1.5 Remove the sand-cone pouring apparatus and return the sand in the tap and funnel to the container.
- 8.1.6 Determine the mass of the residual sand and the container ( $m_8$ ).
- 8.1.7 Carefully remove the template from the test site and sweep all sand from the surface occupied by the template. Ensure the test surface is not disturbed during this process.
- 8.1.8 Place the template on the test surface ensuring that it is in the same position and orientation as that used for the surface correction. Pin the template to the surface of the test site ensuring that it is firmly held in place.

### 8.2 Hole excavation

- 8.2.1 Fill a container with sufficient sand to fill the excavated hole, the central hole in the template, the cone and tap of the sand-cone pouring apparatus plus a quantity which will remain in the funnel after pouring.
- 8.2.2 Determine the mass of sand and the container ( $m_9$ ).

- 8.2.3 Excavate a cylindrical hole to the required depth using the procedure and observing the precautions detailed below:
- Excavate a hole, using the hole of the template as a pattern and working from the centre. The sides of the hole should be essentially vertical.
  - Remove all loose soil from the sides and bottom of the hole with the appropriate tools and carefully deposit the excavated soil in a sealable container, keeping it closed when not in use.
  - During the excavation process, protect the hole and soil deposited in the container from wind and rain to minimise moisture change.
  - At the completion of the excavation, seal the container and ensure that it is protected to prevent moisture and soil loss during transport and storage.
- 8.2.4 Measure and record the depth of the hole.
- 8.2.5 Position the sand pouring cone and sand centrally over the hole in the template.
- 8.2.6 Open the tap on the sand-cone pouring apparatus and allow the sand to run. When no further movement of sand takes place, close the tap. Take care that the apparatus is not disturbed or vibrated while the tap is open. There needs to be sand still remaining in the funnel after pouring (Note 11.2). Remove the apparatus and return the sand in the tap and funnel to the container.
- 8.2.7 Determine the mass of residual sand and the container ( $m_{10}$ ).
- 8.2.8 Determine the mass ( $m_{11}$ ) of the excavated soil.

### **8.3 Foreign material**

- 8.3.1 If foreign material, including up to two occasional large stones which are not representative of the bulk of the material being tested, are found to be included in the soil excavated from the hole, they are to be removed and an adjustment for their mass and volume made to the calculated wet density as follows:
- remove each large stone, brush any fine material from the stone surface and return the fines to the container holding the excavated material
  - determine the mass of foreign material ( $m_{12}$ )
  - determine the volume of the foreign material ( $V_g$ ) directly by displacement of water in a siphon can in accordance with Test Method Q143.

### **8.4 Moisture content**

- 8.4.1 Where the compacted dry density or relative moisture content is required, determine the insitu moisture content ( $w_f$ ) in accordance with Test Method AS 1289.2.1.1 or one of the subsidiary Test Methods AS 1289.2.1.2, AS 1289.2.1.4, AS 1289.2.1.5 or AS 1289.2.1.6 for which a relationship with Test Method AS 1289.2.1.1 has been established and used in accordance with Test Method AS 1289.2.3.1.

## 9 Calculations

9.1 Calculations shall be as follows:

9.2 Calculate the insitu wet density as follows:

$$\rho = \frac{\bar{\rho}_{sand} m_{11}}{(m_9 - m_{10}) - (m_7 - m_8)}$$

- where
- $\rho$  = insitu wet density (t/m<sup>3</sup>)
  - $\bar{\rho}_{sand}$  = mean sand pouring density (t/m<sup>3</sup>)
  - $m_{11}$  = mass of excavated soil (g)
  - $m_9$  = mass of the sand and container before excavation (g)
  - $m_{10}$  = mass of the sand and container after excavating (g)
  - $m_7$  = mass of the sand and container before surface correction (g)
  - $m_8$  = mass of the sand and container after surface correction (g)

9.3 Where there is any foreign material such as occasional large stones, calculate the insitu wet density as follows:

$$\rho = \frac{m_{11} - m_{12}}{\left[ \frac{(m_9 - m_{10}) - (m_7 - m_8)}{\bar{\rho}_{sand}} \right] - V_s}$$

- where
- $\rho$  = insitu wet density (t/m<sup>3</sup>)
  - $m_{11}$  = mass of excavated soil (g)
  - $m_{12}$  = mass of foreign material (g)
  - $m_9$  = mass of the sand and container before excavation (g)
  - $m_{10}$  = mass of the sand and container after excavating (g)
  - $m_7$  = mass of the sand and container before surface correction (g)
  - $m_8$  = mass of the sand and container after surface correction (g)
  - $\bar{\rho}_{sand}$  = mean sand pouring density (t/m<sup>3</sup>)
  - $V_s$  = volume of foreign material (cm<sup>3</sup>)

9.4 Calculate the compacted dry density, as required, as follows:

$$\rho_d = \frac{100\rho}{100 + w_f}$$

- where
- $\rho_d$  = compacted dry density (t/m<sup>3</sup>)
  - $\rho$  = insitu wet density (t/m<sup>3</sup>)
  - $w_f$  = insitu moisture content (%)

## 10 Reporting

The following shall be reported:

### 10.1 Test results:

- a) Compacted dry density to the nearest 0.01 t/m<sup>3</sup>.
- b) Insitu moisture content to the nearest 0.1%.

### 10.2 General information:

- a) Date tested, lot number, test site number, and chainage and offset
- b) Source and description of the material, layer type and nominal depth of layer
- c) Depth of hole (mm).

### 10.3 The number of this Test Method, that is Q141B.

The following may be reported:

### 10.4 Compacted wet density to the nearest 0.01 t/m<sup>3</sup>.

## 11 Notes on method

- 11.1 Alternative Sand – Other sand or grits with particles approximately uniform in size, for example, 2.36 mm to 1.18 mm or 0.600 mm to 0.300 mm sizes, may be used. The particle size of the sand used in a field density test should exceed the size of voids within the compacted material which is mostly related to the size of the largest particles compacted. The sand should be shielded from any moistening, for example, rain, as the resultant bulking would invalidate volume calculations.
- 11.2 Some specifications such as Technical Specification MRTS07A *Insitu Stabilised Subgrades using Quicklime or Hydrated Lime* require testing for layers thicker than 250 mm. For these layers, non-standard calibrations cylinders with depths >250 mm will be required.
- 11.3 When using a wind-shielded sand-cone, it may be necessary to add more sand from the container to the funnel during pouring as the storage capacity of some wind-shielded sand-cones is limited.

**Table 1 – Test-hole and template hole diameter**

Particle size	Test-hole and template hole diameter (mm)	Test-hole depth (mm)
Fine, medium and coarse-grained without retained 37.5 mm stone	150	50–175*
Fine, medium and coarse-grained without retained 37.5 mm stone	200	50–350#
Fine, medium and coarse-grained with retained 37.5 mm stone	200	50–350#

\* Maximum depth for 150 mm template

# Maximum depth for 200 mm template

## Test Method Q142A: Dry density–moisture relationship of soils and crushed rock – standard

### 1 Source

This Test Method is based on AS 1289.5.1.1: *Soil compaction and density tests - Determination of the dry density/moisture content relation of a soil using standard compactive effort*. It differs from this standard in the provision for the addition of stabilising agents.

### 2 Scope

This Test Method sets out a procedure for the determination of the relationship between the moisture content and the dry density of a soil or a crushed rock material, including mixtures containing stabilising agents, when compacted using standard compactive effort (596 kJ/m<sup>3</sup>). Perform compaction over a range of moisture contents to establish the maximum mass of dry material per unit volume achievable for this compactive effort and its corresponding moisture content.

The Test Method is applicable to that portion of a material that passes the 37.5 mm sieve. Material that all passes the 19.0 mm sieve is compacted in a 105 mm diameter mould. Material that has more than 20% rock retained on the 19.0 mm sieve is compacted in a 152 mm diameter mould. Corrections for oversize are not directly included in this method but are detailed in Test Method Q140A when required for compaction control.

### 3 Definitions

For this Test Method, the following definition shall apply:

- 3.1 Allowable working time – the time measured from the commencement of incorporation (that is, mixing) of stabilising agent into the material to completion of compaction and trimming.

### 4 Apparatus

Where appropriate, the working tolerances of apparatus are contained in Table 1. Examples of moulds and rammer are contained in AS 1289.5.1.1, Figures 1 and 2.

The following apparatus is required:

- 4.1 Metal moulds, of a size dependent on the maximum size of material being tested, as follows:

- 4.1.1 For compaction of material passing a 19.0 mm sieve:

Mould A: A cylindrical metal mould having an internal diameter of 105 mm and effective height of 115.5 mm, fitted with a detachable baseplate and a removable collar assembly about 60 mm high both of which can be firmly attached to the mould.

- 4.1.2 For compaction of material passing a 37.5 mm sieve:

Mould B: A cylindrical metal mould having an internal diameter of 152 mm and an effective height of 132.5 mm, fitted with a detachable baseplate and a removable collar assembly about 60 mm high both of which can be firmly attached to the mould.

- 4.2 Rammer, a metal rammer having a 50 mm diameter face, a drop mass of 2700 g and a drop height of 300 mm. Alternatively use a mechanical compactor, provided it meets the essential requirements of drop height, mass and energy input. A mechanical compactor may be used provided the essential dimensions are adhered to and the rammer has a free vertical fall of the correct height with blows being uniformly distributed and in keeping with any prescribed cycle of blows. The design of the compactor allows attachment of the mould to a level and rigid support base. The difference between MDD determinations using manual or mechanical compaction is less than 2%.
- 4.3 Level rigid foundation on which to compact the specimen, for example a sound concrete floor about 100 mm or more in thickness or a concrete block of at least 100 kg mass.
- 4.4 Balance of suitable capacity, with a resolution of at least 1 g and with a limit of performance within the range of  $\pm 5$  g.
- 4.5 Sieves, 37.5 mm, 19.0 mm and 9.5 mm conforming to ISO 3310.
- 4.6 Strong spatula or a suitable knife.
- 4.7 Steel straightedge, about 250 mm long, 25 mm wide and 3 mm thick, preferably with one bevelled edge.
- 4.8 Mixing apparatus, such as a tray, trowel or scoop and water spray suitable for mixing increments of water into the material.
- 4.9 Material height gauge. A flat steel bar, about 250 mm long, 25 mm wide and 1-3 mm thick is satisfactory (Note 10.1).
- 4.10 Sealable containers, suitable for curing the material samples.
- 4.11 Sample extractor, such as a jack, lever frame or other device for extruding compacted specimens from the mould.

## 5 Materials

The following material is required:

- 5.1 Mould oil, a light oil such as Caltex Mould Oil 20 (Note 10.2).

## 6 Procedure

The procedure shall be as follows:

- 6.1 Prepare the bulk sample in accordance with Section 4 of Test Method Q101 to produce a representative subsample of appropriate size. For fresh mixtures of in situ stabilised materials, limit both moisture loss and time loss during preparation.
- 6.2 Further prepare the material by screening the subsample on a 19.0 mm sieve in accordance with Test Method Q101, Steps 5.2.1 to 5.2.2. Ensure that any aggregations are broken up to pass a 9.5 mm sieve and keep any retained 37.5 mm (oversize) rock material.
- 6.3 Determine the approximate percentage retained on the 19.0 mm sieve and whether any material is retained on the 37.5 mm sieve to allow the selection of the appropriate mould size as follows:

- 6.3.1 Where oversize is retained on the 19.0 mm sieve, determine its mass ( $m_{ow}$ ) and the mass of the passing 19.0 mm (undersize) material ( $m_{uw}$ ). Calculate the wet mass of material as follows:

$$m_w = m_{ow} + m_{uw}$$

- where  $m_w$  = wet mass of material (g)  
 $m_{ow}$  = wet mass of > 19.0 mm oversize material (g)  
 $m_{uw}$  = wet mass of < 19.0 mm undersize material (g)

- 6.3.2 Where oversize is retained on the 19.0 mm sieve, calculate the percentage oversize on a wet mass basis as follows:

$$P_{ow} = \frac{100m_{ow}}{m_w}$$

- where  $P_{ow}$  = percentage by wet mass of > 19.0 mm oversize material  
 $m_{ow}$  = wet mass of > 19.0 mm oversize material (g)  
 $m_w$  = wet mass of material (g)

- 6.3.3 If the calculated percentage oversize ( $P_{ow}$ ) is greater than 20%, screen the material retained on the 19.0 mm sieve on the 37.5 mm sieve. Where oversize is retained on the 37.5 mm sieve, determine its mass of ( $m_{ow}$ ). Calculate the percentage oversize on a wet basis as follows:

$$P_{ow} = \frac{100m_{ow}}{m_w}$$

- where  $P_{ow}$  = percentage by wet mass of > 37.5 mm oversize material  
 $m_{ow}$  = wet mass of > 37.5 mm oversize material (g)  
 $m_w$  = wet mass of material (g)

- 6.4 If required, retain the material retained on the 19.0 mm or 37.5 mm sieve for determining the mass, volume and percentage of oversize.
- 6.5 Select the size fraction and mould size to be used in the compaction test using the criteria in Table 2. Record the mould used (A or B). When necessary, recombine the material passing 37.5 mm portion with the material passing the 19.0 mm portion and thoroughly remix.
- 6.6 Prepare four or more representative portions of the sieved material in accordance with Test Method Q101, Steps 5.2.4 to 5.2.5 as follows:
- 6.6.1 Each test portion is to be of sufficient quantity to produce a compacted specimen in excess of the volume of the mould (Notes 10.3).
- 6.6.2 Where oversize is present and a correction to the MDD, or OMC is required in accordance with Test Method Q140A. Prepare an additional portion of the sieved material and determine its moisture content of undersize material ( $w_u$ ) in accordance with Test Method AS 1289.2.1.1 or one of the subsidiary Test Methods AS 1289.2.1.2, AS 1289.2.1.4, AS 1289.2.1.5 or AS 1289.2.1.6 for which a relationship with Test Method AS 1289.2.1.1 has been established and used in accordance with Test Method AS 1289.2.3.1.



- 6.6.3 Where a correction to the MDD or OMC is required in accordance with Test Method Q140A. Determine the dry mass of oversize, volume of oversize and percentage of oversize in accordance with Test Method Q143, using the wet mass of oversize ( $m_{ow}$ ) and wet mass of material ( $m_w$ ) determined at Step 6.3.2 (Mould A) or Step 6.3.3 (Mould B) and the moisture content of undersize material ( $w_u$ ) of the undersize from Step 6.6.2.
- 6.7 Take the portions of material prepared in Step 6.6, mix them with the stabilising agent if appropriate, and prepare each portion for compaction as follows:
- 6.7.1 Material only
- Thoroughly mix each test portion in turn with sufficient water so that the range of their moisture contents should straddle OMC. The moisture increments between portions shall be essentially equal and ensure that the moisture steps are not excessive for the material type (Notes 9.6 and 9.7).
  - After mixing, place each test portion in a sealed container and allowed to cure for an appropriate time for the material (refer to Table 3) (Notes 10.6 and 10.7).
  - Record the times of commencement and completion of the curing.
  - Record the method for determining the plasticity level (refer to Table 3), that is, test method, source records or visual/tactile assessment.
- 6.7.2 Material with stabilising agent incorporated in the laboratory
- Incorporate the stabilising agent with the material and precondition the mixture in accordance with Test Method Q135A. When selecting compaction moisture contents, ensure that the range of moisture contents will straddle the OMC. Use essentially equal increments of moisture between test portions and ensure that the moisture steps are not excessive for the material type (Notes 10.4 and 10.5).
  - Record the times of commencement and completion of the curing.
- 6.7.3 Material with stabilising agent incorporated in situ or plant-mixed.
- Thoroughly mix each test portion in turn with sufficient water so that the range of their moisture contents should straddle OMC. The moisture increments between portions shall be essentially equal and ensure that the moisture steps are not excessive for the material type (Notes 10.4 and 10.5).
  - Place the mixed test portions in separate sealable containers.
  - Record the times of commencement and completion of the curing.
- 6.8 Clean and assemble the mould and baseplate, lightly oiling the internal surfaces. Inspect and clean the rammer or mechanical compactor and ensure that it is free in the guide.
- 6.9 Determine the mass ( $m_1$ ) of the mould and baseplate, attach the collar and place the assembly on the rigid support base, checking to ensure that the mould is firmly seated and will not rock due to distortion of the mould baseplate or deterioration of the support base.
- 6.10 Ensure the compaction of each portion containing stabilising agent is completed within the following limits:
- 65 minutes, where the stabilising agent incorporated in the laboratory, timed from the first addition of mixing water to the host material and stabilising agent.
  - Allowable working time, where the stabilising agent is incorporated in situ or plant-mixed, timed from incorporation (that is, mixing) of stabilising agent into the unstabilised material.

- 6.11 Compact the test portions as follows:
- 6.11.1 Material passing the 19.0 mm sieve only (Mould A):
- a) Take one test portion, mix it thoroughly and compact it into the assembled mould in three layers so that the compacted height of the material in the mould is from 38 mm to 43 mm in the first layer, from 77 mm to 82 mm in the second layer and from 116 mm to 121 mm in the third layer. Discard specimens that do not meet one or more of these height tolerances.
  - b) Compact each layer by 25 uniformly distributed blows of the rammer falling freely from a height of 300 mm (Note 10.8). Use only sufficient material, which is representative of the portion, to meet the layer heights above (Note 10.9).
- 6.11.2 Material passing the 37.5 mm sieve (Mould B):
- a) Take one test portion, mix it thoroughly and compact it into the assembled mould in three layers so that the compacted height of the material in the mould is from 44 mm to 49 mm in the first layer, from 89 mm to 94 mm in the second layer and from 133 mm to 138 mm in the third layer. Discard specimens that do not meet one or more of these height tolerances.
  - b) Compact each layer by 60 uniformly distributed blows of the rammer falling freely from a height of 300 mm (Note 10.8). Use only sufficient material, which is representative of the portion, to meet the layer heights above (Note 10.9).
- 6.12 Free the material from around the inside of the collar and then carefully remove the collar.
- 6.13 Trim the surface of the specimen while the mould is still attached to the baseplate. This operation depends upon the characteristics of the material as follows:
- a) For an essentially fine-grained material, trim the compacted material level with the top of the mould by means of the straightedge. Use smaller sized material to patch any hollows developed in the surface from removal of coarse material during trimming.
  - b) For a material containing stones, trim the compacted material in the mould ensuring that portions of stones standing above the top of the mould are compensated by hollows of about the equivalent volume below the top of the mould.
- 6.14 Determine the mass ( $m_2$ ) of the mould, baseplate and compacted material.
- 6.15 Immediately remove the compacted specimen from the mould and either use the whole specimen or obtain a representative sample from its full height. Determine the moisture content ( $w$ ) of this sample in accordance with Test Method AS 1289.2.1.1 or one of the subsidiary Test Methods AS 1289.2.1.2, AS 1289.2.1.4, AS 1289.2.1.5 or AS 1289.2.1.6 for which a relationship with Test Method AS 1289.2.1.1 has been established and used in accordance with Test Method AS 1289.2.3.1. Where specimens are compacted in the field, moisture content samples must be returned to a laboratory and placed in drying ovens within the same work shift as the stabilisation works for the corresponding lot.
- 6.16 Discard the used material. Do not reuse material from a previously compacted specimen.
- 6.17 Repeat Steps 6.8 to 6.15 for the other test portions of prepared material to obtain a minimum of four points, at least two of which are drier and one wetter than OMC, to satisfactorily define the dry density / moisture content relationship.

- 6.18 If the OMC has not been straddled or is imprecisely defined, use additional test portions prepared and cured at appropriate moisture contents in the same manner as in Steps 6.6 to 6.7, and compacted as in Steps 6.8 to 6.15 (Note 10.10).
- 6.19 For material with stabilising agent incorporated insitu or plant-mixed, record the date and time at the completion of compaction.

## 7 Calculations

Calculations shall be as follows:

- 7.1 For each specimen, wet density of material ( $\rho_w$ ) as follows:

$$\rho_w = \frac{m_2 - m_1}{V}$$

- where  $\rho_w$  = wet density of material (t/m<sup>3</sup>)  
 $m_2$  = mass of mould, baseplate and compacted material (g)  
 $m_1$  = mass of mould and baseplate (g)  
 $V$  = mould volume (cm<sup>3</sup>)

- 7.2 For each specimen, dry density of material ( $\rho_d$ ) as follows:

$$\rho_d = \frac{100\rho_w}{100+w}$$

- where  $\rho_d$  = dry density of material (t/m<sup>3</sup>)  
 $\rho_w$  = wet density of material (t/m<sup>3</sup>)  
 $w$  = moisture content of the specimen (%)

- 7.3 Moisture content points for the chosen air voids line, from the soil particle density (Note 10.11) by using dry density values corresponding to the lowest and highest values determined in Step 7.2 as follows:

$$w = \frac{100 - V_a}{\rho_d} - \frac{100}{\rho_{st}}$$

- where  $w$  = moisture content, expressed as a percentage of the mass of dry material  
 $V_a$  = volume of chosen air voids, expressed as a percentage of the volume of undried material  
 $\rho_d$  = dry density of material (t/m<sup>3</sup>)  
 $\rho_{st}$  = soil particle density (t/m<sup>3</sup>)

- 7.4 Plot the dry densities obtained for the compacted specimens against their corresponding moisture contents. Draw a smooth curve of best fit through the resulting points with the wet leg of the curve tending parallel to the air voids line.
- 7.5 Plot the air voids line on the graph constructed at Step 7.4.

## 8 Reporting

The following shall be reported:

### 8.1 Compaction Results:

- a) The plot of dry density against moisture content together with the plot of the chosen air voids line.
- b) The dry density corresponding to the maximum point on the moisture content/dry density curve, as the MDD to the nearest 0.01 t/m<sup>3</sup>.
- c) The percentage moisture content corresponding to the MDD on the moisture content/dry density curve, as the OMC to the nearest 0.5%.
- d) The Test Method used to determine the moisture content of the compacted material.
- e) Compaction standard used, that is, standard.
- f) Method of curve fitting, for example, hand drawn, cubic spline, n<sup>th</sup> order polynomial and so on.

### 8.2 Oversize results, when measured:

- a) The percentage of any oversize as determined by Test Method Q143
- b) The sieve on which the material is retained (19.0 mm or 37.5 mm).

### 8.3 For material without stabilising agent:

- a) Duration of curing to the nearest hour.
- b) Method for determining the plasticity level (refer to Table 3), that is, Test Method, source records or visual/tactile assessment.

### 8.4 For field mixed material other than foamed bitumen:

- a) When stabilised agent has been incorporated insitu, the elapsed time between addition of stabilising agent (mixing) and the completion of laboratory compaction to the nearest 15 minutes (0.25 hours)
- b) Source and description of the host material
- c) Source, type, ATIC Registration number of the stabilising agent(s)
- d) Stabilising agent(s) content(s) (%)
- e) Admixture content (%) or Admixture volume (mL/100 kg of stabilising agent)

### 8.5 For materials with foamed bitumen:

- a) The date and time of mixing.
- b) Bitumen grade, source and target percentage added.
- c) Foaming agent used and amount added.
- d) Type of secondary binder used, source and percentage added.

### 8.6 Additional information:

- a) Sample number, if assigned values of maximum dry density and optimum moisture content are to be assigned in accordance with Test Method Q144A.

### 8.7 The number of this Test Method, that is Q142A.

## 9 Precision

The precision of the test is shown in Table 4. These values, in 95% of cases, should not be exceeded by the difference between any two results, expressed as a percentage of the mean value. The values shown are based on test results from a wide variety of materials but, in some cases such as heavy clays, these values may be exceeded. Precision may be enhanced by employing fractionation as the preferred option for test portion preparation.

## 10 Notes on method

- 10.1 A material height gauge, which allows monitoring of the height of compacted material relative to the top of either a Mould A or a Mould B, can be made from a steel bar and marked as follows:
  - 10.1.1 Mould A: Commencing at one end of the bar, measure and mark distances of:
    - a) 5.5 mm for the upper range of the third layer
    - b) 33.5 mm and 38.5 mm for the acceptable range of the second layer, and
    - c) 72.5 mm and 77.5 mm for the acceptable range of the first layer.
  - 10.1.2 Mould B: Using another face and commencing at one end of the bar, measure and mark distances of:
    - a) 5.5 mm for the upper range of the third layer
    - b) 38.5 mm and 43.5 mm for the acceptable range of the second layer, and
    - c) 83.5 mm and 88.5 mm for the acceptable range of the first layer.
  - 10.1.3 Mark each face with the appropriate mould size (A or B).
- 10.2 Before handling oils, the operator should consult the relevant SDS.
- 10.3 When adding a stabilising agent in the laboratory, it may be necessary to dry the soil sample before preparation. The material needs to be sufficiently dry to allow uniform mixing of the stabilising agent into the material to minimise variability within the mixture.
- 10.4 Suitable intervals for moisture increments range from 1% for a gravel to 2 to 3% for a clay.
- 10.5 It is important to mix water thoroughly into the material and the test portion cured for sufficient time to allow the even distribution of water throughout the material.
- 10.6 Where the liquid limit has not been determined in accordance with Test Methods Q104A or Q104D, use either a liquid limit from source records or an estimate based on a visual/tactile assessment for estimating the curing time for the MDR test portions.
- 10.7 When using the MDD and OMC for compaction control testing, the curing time may be limited to two hours. Provided the condition of the prepared sample is within  $\pm 4\%$  of the OMC of the material.
- 10.8 During compaction, material can build up on the surface of the rammer. This is particularly evident at moisture contents near to and above OMC. To prevent the cushioning effect caused by this build-up, inspect the rammer face and clean, if necessary, during the compaction process.

- 10.9 It is necessary to control the total amount of mixture compacted since, if the amount of material struck off after removing the collar is too great, the test results will be inaccurate as the energy input will not be within the required tolerances of Table 1. Some large particles may protrude a little more than 5 mm above the surface for the passing 37.5 mm material. Make suitable allowances in the trimming process for these particles but the mean height of the compacted specimen before trimming should not exceed 5 mm above the mould.
- 10.10 If, with increasing moisture content, the wet mass of compacted material markedly increases and then starts to decrease, the OMC probably has been straddled adequately. For materials with low plasticity and high permeability, points significantly wetter than OMC may not be reliable due to loss of water during compaction.
- 10.11 Obtain the value of the material's soil particle density for calculating the air voids lines using the method described in Test Method AS 1289.3.5.1 or assume based on previous tests. A rough check on the material soil particle density is to select the dry density and moisture content of the wettest data point, nominate a percent air voids (2% often gives a satisfactory result) and calculate a soil particle density as follows:

$$\rho_{st} = \frac{100\rho_d}{(100-V_a)-\rho_d w}$$

- where
- $\rho_{st}$  = soil particle density (t/m<sup>3</sup>)
  - $\rho_d$  = dry density of material (t/m<sup>3</sup>)
  - $V_a$  = nominated air voids (%)
  - $w$  = moisture content expressed as a percentage of the mass of dry material

The material's soil particle density so derived is the assumed value.

**Table 1 - Dimensions and tolerances for suitable moulds and rammer**

Apparatus	Dimension	Tolerance
<b>Moulds</b>		
Mould A: 105 diameter		
Internal diameter (mm)	105.0	± 0.5 *
Effective height (mm)	115.5	± 0.5 *
Nominal volume (cm <sup>3</sup> )	1000	± 15
Mould B: 152 mm diameter		
Internal diameter (mm)	152.0	± 1.0 *
Effective height (mm)	132.5	± 0.5 *
Nominal volume (cm <sup>3</sup> )	2400	± 35

Apparatus	Dimension	Tolerance
<b>Rammer</b>		
Diameter; round foot (mm)	50	± 0.4
Area of rammer (mm <sup>2</sup> )	1964	± 31
Drop (mm)	300	± 2.0 ‡
Mass (kg)	2.7	± 0.01 ‡
Energy delivered per blow (J)	7.94	± 0.08
Number of layers	3	
Number of blows/layer: Mould A	25	
Mould B	60	
Energy input (kJ/m <sup>3</sup> )	596	± 14

\* Either but not both of the tolerances may be exceeded provided the specified tolerance on volume is not exceeded.

‡ Either but not both of the tolerances may be exceeded provided the appropriate tolerance on energy delivered per blow is not exceeded.

**Table 2 - Size fraction and mould size**

Percentage retained		Test mould	Portion to be tested
37.5 mm sieve	19.0 mm sieve		
> 20	–		Not tested by this method
≤ 20	> 20	B	All material passing 37.5 mm sieve
–	≤ 20	A	All material passing 19.0 mm sieve

**Table 3 – Minimum curing time**

Plasticity	Condition of prepared sample	
	Sample moisture content within OMC ± 2%	Sample moisture content outside OMC ± 2%
Sands and granular material*	2 h	2 h
Low (LL ≤ 35%)	24 h	48 h
Medium (35 < LL ≤ 50%)	48 h	96 h (4 days)
High (LL > 50%)	96 h (4 days)	168 h (7 days)

\* These can include naturally occurring sands and gravels, crushed rocks and manufactured materials with a fines (< 0.075 mm) content typically less than 12% and a liquid limit < 35%.

**Table 4 - Acceptable range of two results expressed as a percentage of mean value**

Precision measure	MDD	OMC
Repeatability	2	10
Reproducibility	4	20

## Test Method Q142B: Dry density – moisture relationship of soils and crushed rock – modified

### 1 Source

This Test Method is based on AS 1289.5.2.1: *Soil compaction and density tests – Determination of the dry density / moisture content relation of a soil using modified compactive effort*. It differs from this standard in the provision for the addition of stabilising agents.

### 2 Scope

This Test Method sets out a procedure for the determination of the relationship between the moisture content and the dry density of a soil or a crushed rock material, including mixtures containing stabilising agents, when compacted using modified compactive effort (2703 kJ/m<sup>3</sup>). Perform compaction over a range of moisture contents to establish the maximum mass of dry material per unit volume achievable for this compactive effort and its corresponding moisture content.

The Test Method is applicable to that portion of a material that passes the 37.5 mm sieve. Material that all passes the 19.0 mm sieve is compacted in a 105 mm diameter mould. Material that has more than 20% rock retained on the 19.0 mm sieve is compacted in a 152 mm diameter mould. Corrections for oversize are not directly included in this method but are detailed in Test Method Q140A when required for compaction control.

### 3 Definitions

For this Test Method, the following definitions shall apply:

- 3.1 Allowable working time – the time measured from the commencement of incorporation (that is, mixing) of stabilising agent into the material to completion of compaction and trimming.

### 4 Apparatus

Where appropriate, the working tolerances of apparatus are contained in Table 1. Examples of moulds and rammer are contained in AS 1289.5.2.1, Figures 1 and 2.

The following apparatus is required:

- 4.1 Metal moulds, of a size dependent on the maximum size of material being tested, as follows:

- 4.1.1 For compaction of material passing a 19.0 mm sieve:

Mould A: A cylindrical metal mould having an internal diameter of 105 mm and effective height of 115.5 mm, fitted with a detachable baseplate and a removable collar assembly about 60 mm high both of which can be firmly attached to the mould.

- 4.1.2 For compaction of material passing a 37.5 mm sieve:

Mould B: A cylindrical metal mould having an internal diameter of 152 mm and an effective height of 132.5 mm, fitted with a detachable baseplate and a removable collar assembly about 60 mm high both of which can be firmly attached to the mould.



- 4.2 Rammer, a metal rammer having a 50 mm diameter face, a drop mass of 4900 g and a drop height of 450 mm. Alternatively use a mechanical compactor, provided it meets the essential requirements of drop height, mass and energy input. A mechanical compactor may be used provided the essential dimensions are adhered to and the rammer has a free vertical fall of the correct height with blows being uniformly distributed and in keeping with any prescribed cycle of blows. The design of the compactor allows attachment of the mould to a level and rigid support base. The difference between MDD determinations using manual or mechanical compaction is less than 2%.
- 4.3 Level rigid foundation on which to compact the specimen, for example a sound concrete floor about 100 mm or more in thickness or a concrete block of at least 100 kg mass.
- 4.4 Balance of suitable capacity, with a resolution of at least 1 g and with a limit of performance within the range of  $\pm 5$  g.
- 4.5 Sieves, 37.5 mm, 19.0 mm and 9.5 mm conforming to ISO 3310.
- 4.6 Strong spatula or a suitable knife.
- 4.7 Steel straightedge, about 250 mm long, 25 mm wide and 3 mm thick, preferably with one bevelled edge.
- 4.8 Mixing apparatus, such as a tray, trowel or scoop and water spray suitable for mixing increments of water into the material.
- 4.9 Material height gauge. A flat steel bar, about 250 mm long, 25 mm wide and 1-3 mm thick is satisfactory (Note 10.1).
- 4.10 Sealable containers, suitable for curing the material samples.
- 4.11 Sample extractor, such as a jack, lever frame or other device for extruding compacted specimens from the mould.

## **5 Materials**

The following material is required:

- 5.1 Mould oil, a light oil such as Caltex Mould Oil 20 (Note 10.2).

## **6 Procedure**

The procedure shall be as follows:

- 6.1 Prepare the bulk sample in accordance with Section 4 of Test Method Q101 to produce a representative subsample of appropriate size. For fresh mixtures of insitu stabilised materials, limit both moisture loss and time loss during preparation.
- 6.2 Further prepare the material by screening the subsample on a 19.0 mm sieve in accordance with Test Method Q101, Steps 5.2.1 to 5.2.2. Ensure that any aggregations are broken up to pass a 9.5 mm sieve and keep any retained 37.5 mm (oversize) rock material.

6.3 Determine the approximate percentage retained on the 19.0 mm sieve and whether any material is retained on the 37.5 mm sieve to allow the selection of the appropriate mould size as follows:

6.3.1 Where oversize is retained on the 19.0 mm sieve, determine its mass ( $m_{ow}$ ) and the mass of the passing 19.0 mm (undersize) material ( $m_{uw}$ ). Calculate the wet mass of material as follows:

$$m_w = m_{ow} + m_{uw}$$

where  $m_w$  = wet mass of material (g)  
 $m_{ow}$  = wet mass of > 19.0 mm oversize material (g)  
 $m_{uw}$  = wet mass of < 19.0 mm undersize material (g)

6.3.2 Where oversize is retained on the 19.0 mm sieve, calculate the percentage oversize on a wet mass basis as follows:

$$P_{ow} = \frac{100m_{ow}}{m_w}$$

where  $P_{ow}$  = percentage by wet mass of > 19.0 mm oversize material  
 $m_{ow}$  = wet mass of > 19.0 mm oversize material (g)  
 $m_w$  = wet mass of material (g)

6.3.3 If the calculated percentage oversize ( $P_{ow}$ ) is greater than 20%, screen the material retained on the 19.0 mm sieve on the 37.5 mm sieve. Where oversize is retained on the 37.5 mm sieve, determine its mass of ( $m_{ow}$ ). Calculate the percentage oversize on a wet basis as follows:

$$P_{ow} = \frac{100m_{ow}}{m_w}$$

where  $P_{ow}$  = percentage by wet mass of > 37.5 mm oversize material  
 $m_{ow}$  = wet mass of > 37.5 mm oversize material (g)  
 $m_w$  = wet mass of material (g)

6.4 If required, retain the material retained on the 19.0 mm or 37.5 mm sieve for determining the mass, volume and percentage of oversize.

6.5 Select the size fraction and mould size to be used in the compaction test using the criteria in Table 2. Record the mould used (A or B). When necessary, recombine the material passing 37.5 mm portion with the material passing the 19.0 mm portion and thoroughly remix.

6.6 Prepare four or more representative portions of the sieved material in accordance with Test Method Q101, Steps 5.2.3 to 5.2.6 as follows:

6.6.1 Each test portion is to be of sufficient quantity to produce a compacted specimen in excess of the volume of the mould (Note 10.3).

- 6.6.2 Where oversize is present and a correction to the laboratory MDD, or OMC is required in accordance with Test Method Q140A. Prepare an additional portion of the sieved material and determine its moisture content of undersize material ( $w_u$ ) in accordance with Test Method AS 1289.2.1.1 or one of the subsidiary Test Methods AS 1289.2.1.2, AS 1289.2.1.4, AS 1289.2.1.5 or AS 1289.2.1.6 for which a relationship with Test Method AS 1289.2.1.1 has been established and used in accordance with Test Method AS 1289.2.3.1.
- 6.6.3 Where a correction to the laboratory reference MDD or OMC is required in accordance with Test Method Q140A. Determine the dry mass of oversize, volume of oversize and percentage of oversize as detailed in Test Method Q143, using the wet mass of oversize ( $m_{ow}$ ) and wet mass of material ( $m_w$ ) determined at Step 6.3.2 (Mould A) or Step 6.3.3 (Mould B) and the moisture content of undersize material ( $w_u$ ) of the undersize from Step 6.6.2.
- 6.7 Take the portions of material prepared in Step 6.6, mix them with the stabilising agent if appropriate, and prepare each portion for compaction as follows:
- 6.7.1 Material only
- Thoroughly mix each test portion in turn with sufficient water so that the range of their moisture contents should straddle OMC. The moisture increments between portions shall be essentially equal and ensure that the moisture steps are not excessive for the material type (Notes 10.4 and 10.5).
  - Place the mixed test portions in separate sealable containers and allow the portions to cure for the specified period of time for the material (refer to Table 3) (Notes 10.6 and 10.7).
  - Record the times of commencement and completion of the curing.
  - Record the method for determining the plasticity level (refer to Table 3), that is, test method, source records or visual / tactile assessment.
- 6.7.2 Material with stabilising agent incorporated in the laboratory
- Incorporate the stabilising agent with the material and precondition the mixture in accordance with Test Method Q135A. When selecting compaction moisture contents, ensure that the range of moisture contents will straddle the OMC. Use essentially equal increments of moisture between test portions and ensure that the moisture steps are not excessive for the material type (Notes 10.4 and 10.5).
  - Record the times of commencement and completion of the curing.
- 6.7.3 Material with stabilising agent incorporated insitu or plant-mixed
- Thoroughly mix each test portion in turn with sufficient water so that the range of their moisture contents should straddle OMC. The moisture increments between portions shall be essentially equal and ensure that the moisture steps are not excessive for the material type (Notes 10.4 and 10.5).
  - Place the mixed test portions in separate sealable containers.
  - Record the times of commencement and completion of the curing.
- 6.8 Clean and assemble the mould and baseplate, lightly oiling the internal surfaces. Inspect and clean the rammer or mechanical compactor and ensure that it is free in the guide.
- 6.9 Determine the mass ( $m_1$ ) of the mould and baseplate, attach the collar and place the assembly on the rigid support base, checking to ensure that the mould is firmly seated and will not rock due to distortion of the mould baseplate or deterioration of the support base.

- 6.10 Ensure the compaction of each portion containing stabilising agent is completed within the following limits:
- a) 65 minutes, where the stabilising agent incorporated in the laboratory, timed from the first addition of mixing water to the host material and stabilising agent.
  - b) Allowable working time, where the stabilising agent incorporated in situ or plant-mixed, timed from incorporation (that is, mixing) of stabilising agent into the unstabilised material.
- 6.11 Compact the test portions as follows:
- 6.11.1 Material passing the 19.0 mm sieve only (Mould A):
- a) Take one test portion, mix it thoroughly and compact it into the assembled mould in five layers so that the compacted height of the material in the mould is from 23 mm to 28 mm in the first layer, from 47 mm to 52 mm in the second layer, from 70 mm to 75 mm in the third layer, 93 mm to 98 mm in the fourth layer and from 116 mm to 121 mm in the fifth layer. Discard specimens that do not meet one or more of these height tolerances.
  - b) Compact each layer by 25 uniformly distributed blows of the rammer falling freely from a height of 450 mm (Note 0.8). Use only sufficient material, which is representative of the portion, to meet the layer heights above (Note 10.9).
- 6.11.2 Material passing the 37.5 mm sieve (Mould B):
- a) Take one test portion, mix it thoroughly and compact it into the assembled mould in three layers so that the compacted height of the material in the mould is from 44 mm to 49 mm in the first layer, from 89 mm to 94 mm in the second layer and from 133 mm to 138 mm in the third layer. Discard specimens that do not meet one or more of these height tolerances.
  - b) Compact each layer by 100 uniformly distributed blows of the rammer falling freely from a height of 450 mm (Note 10.8). Use only sufficient material, which is representative of the portion, to meet the layer heights above (Note 10.91).
- 6.12 Free the material from around the inside of the collar and then carefully remove the collar.
- 6.13 Trim the surface of the specimen while the mould is still attached to the baseplate. This operation depends upon the characteristics of the material as follows:
- 6.13.1 For an essentially fine-grained material, trim the compacted material level with the top of the mould by means of the straightedge. Use smaller sized material to patch any hollows developed in the surface from removal of coarse material during trimming.
- 6.13.2 For a material containing stones, trim the compacted material in the mould ensuring that portions of stones standing above the top of the mould are compensated by hollows of about the equivalent volume below the top of the mould.
- 6.14 Determine the mass ( $m_2$ ) of the mould, baseplate and compacted material.
- 6.15 Immediately remove the compacted specimen from the mould and either use the whole specimen or obtain a representative sample from its full height. Determine the moisture content ( $w$ ) of this sample in accordance with Test Method AS 1289.2.1.1 or one of the subsidiary Test Methods AS 1289.2.1.2, AS 1289.2.1.4, AS 1289.2.1.5 or AS 1289.2.1.6 for which a relationship with Test Method AS 1289.2.1.1 has been established and used in accordance with Test Method AS 1289.2.3.1. Where specimens are compacted in the field, moisture content samples must be returned to a laboratory and placed in drying ovens within the same work shift as the stabilisation works for the corresponding lot.

- 6.16 Discard the used material. Do not reuse material from a previously compacted specimen.
- 6.17 Repeat Steps 6.8 to 6.15 for the other test portions of prepared material to obtain a minimum of four points, at least two of which are drier and one wetter than OMC, to satisfactorily define the dry density / moisture content relationship.
- 6.18 If the OMC has not been straddled or is imprecisely defined, use additional test portions prepared and cured at appropriate moisture contents in the same manner as in Steps 6.6 to 6.7, and compacted as in Steps 6.8 to 6.15 (Note 10.10).
- 6.19 For material with stabilising agent incorporated insitu or plant-mixed, record the date and time at the completion of compaction.

## 7 Calculations

Calculations shall be as follows:

- 7.1 For each specimen, wet density of material ( $\rho_w$ ) as follows:

$$\rho_w = \frac{m_2 - m_1}{V}$$

- where  $\rho_w$  = wet density of material (t/m<sup>3</sup>)  
 $m_2$  = mass of mould, baseplate and compacted material (g)  
 $m_1$  = mass of mould and baseplate (g)  
 $V$  = mould volume (cm<sup>3</sup>)

- 7.2 For each specimen, density of dry material ( $\rho_d$ ) as follows:

$$\rho_d = \frac{100\rho_w}{100+w}$$

- where  $\rho_d$  = dry density of material (t/m<sup>3</sup>)  
 $\rho_w$  = wet density of material (t/m<sup>3</sup>)  
 $w$  = moisture content of the specimen (%)

- 7.3 Moisture content points for the chosen air voids line, from the soil particle density (Note 10.11) by using dry density values corresponding to the lowest and highest values determined in Step 7.2 as follows:

$$w = \frac{100 - V_a}{\rho_d} - \frac{100}{\rho_{st}}$$

- where  $w$  = moisture content, expressed as a percentage of the mass of the dry material (%)  
 $V_a$  = volume of chosen air voids, expressed as a percentage of the volume of the un-dried material  
 $\rho_d$  = dry density of material (t/m<sup>3</sup>)  
 $\rho_{st}$  = soil particle density (t/m<sup>3</sup>)

- 7.4 Plot the dry densities obtained for the compacted specimens against their corresponding moisture contents. Draw a smooth curve of best fit through the resulting points with the wet leg of the curve tending parallel to the air voids line.
- 7.5 Plot the air voids line on the graph constructed at Step 7.4.

## 8 Reporting

The following shall be reported:

### 8.1 Compaction results:

- a) The plot of dry density against moisture content together with the plot of the chosen air voids line.
- b) The dry density corresponding to the maximum point on the moisture content/dry density curve as the MDD to the nearest 0.01 t/m<sup>3</sup>.
- c) The percentage moisture content corresponding to the maximum dry density on the moisture content/dry density curve as the optimum moisture content to the nearest 0.5%.
- d) Compaction standard used, that is, modified
- e) Method of curve fitting, for example, hand drawn or cubic spline, nth order polynomial and so on.

### 8.2 Oversize results, when measured:

- a) The percentage of any oversize as determined by Test Method Q143
- a) The sieve on which the material is retained (19.0 mm or 37.5 mm).

### 8.3 For material without stabilising agent:

- a) Duration of curing to the nearest hour.
- b) Method for determining the plasticity level (refer to Table 3), that is, test method, source records or visual/tactile assessment.

### 8.4 For field mixed material other than foamed bitumen:

- a) When stabilised agent has been incorporated insitu, the elapsed time between addition of stabilising agent (mixing) and the completion of laboratory compaction to the nearest 15 minutes (0.25 hours)
- b) Source and description of the host material
- c) Source, type, ATIC Registration number of the stabilising agent(s)
- d) Stabilising agent(s) content(s) (%)
- e) Admixture content (%) or Admixture volume (mL/100 kg of stabilising agent)

### 8.5 For materials with foamed bitumen:

- a) The date and time of mixing.
- b) Bitumen grade, source and target percentage added.
- c) Foaming agent used and amount added.
- d) Type of secondary binder used, source and percentage added.

### 8.6 Additional information

- a) Sample number, if assigned values of maximum dry density and optimum moisture content are to be assigned in accordance with Test Method Q144A.

### 8.7 The number of this test method, that is Q142B.

## 9 Precision

The precision of the test is shown in Table 4. These values, in 95% of cases, should not be exceeded by the difference between any two results, expressed as a percentage of the mean value. The values shown are based on test results from a wide variety of materials but, in some cases such as heavy clays, these values may be exceeded. Precision may be enhanced by employing fractionation as the preferred option for test portion preparation.

## 10 Notes on method

- 10.1 A material height gauge, which allows monitoring of the height of compacted material relative to the top of either a Mould A or a Mould B, can be made from a steel bar and marked as follows:
- 10.1.1 Mould A: Commencing at one end of the bar, measure and mark distances of:
- a) 5.5 mm for the upper range of the fifth layer
  - b) 17.5 mm and 22.5 mm for the acceptable range of the fourth layer
  - c) 40.5 mm and 45.5 mm for the acceptable range of the third layer
  - d) 63.5 mm and 68.5 mm for the acceptable range of the second layer, and
  - e) 87.5 mm and 92.5 mm for the acceptable range of the first layer.
- 10.1.2 Mould B: Using another face and commencing at one end of the bar, measure and mark distances of:
- a) 5.5 mm for the upper range of the third layer
  - b) 38.5 mm and 43.5 mm for the acceptable range of the second layer, and
  - c) 83.5 mm and 88.5 mm for the acceptable range of the first layer.
- 10.1.3 Mark each face with the appropriate mould size (A or B).
- 10.2 Before handling oils, the operator should consult the relevant SDS.
- 10.3 When adding a stabilising agent in the laboratory, it may be necessary to dry the soil sample before preparation. The material needs to be sufficiently dry to allow uniform mixing of the stabilising agent into the material to minimise variability within the mixture.
- 10.4 Suitable intervals for moisture increments range from 1% for a gravel to 2 to 3% for a clay.
- 10.5 It is important to mix water thoroughly into the material and the test portion cured for sufficient time to allow the even distribution of water throughout the material.
- 10.6 Where the liquid limit has not been determined in accordance with Test Methods Q104A or Q104D, use either a liquid limit from source records or an estimate based on a visual/tactile assessment for estimating the curing time for the MDR test portions.
- 10.7 When using the MDD and OMC for compaction control testing, the curing time may be limited to two hours. Provided the condition of the prepared sample is within  $\pm 4\%$  of the optimum moisture content of the material.
- 10.8 During compaction, material can build up on the surface of the rammer. This is particularly evident at moisture contents near to and above OMC. To prevent the cushioning effect caused by this build-up, inspect the rammer face and clean if necessary during the compaction process.

- 10.9 It is necessary to control the total amount of mixture compacted since, if the amount of material struck off after removing the collar is too great, the test results will be inaccurate as the energy input will not be within the required tolerances of Table 1. Some large particles may protrude a little more than 5 mm above the surface for the passing 37.5 mm material. Make suitable allowances in the trimming process for these particles but the mean height of the compacted specimen before trimming should not exceed 5 mm above the mould.
- 10.10 If, with increasing moisture content, the wet mass of compacted material markedly increases and then starts to decrease, the OMC probably has been straddled adequately. For materials with low plasticity and high permeability, points significantly wetter than OMC may not be reliable due to loss of water during compaction.
- 10.11 Obtain the value of the material's soil particle density for calculating the air voids lines using the method described in AS 1289.3.5.1 or assume based on previous tests. A rough check on the material soil particle density is to select the dry density and moisture content of the wettest data point, nominate a percent air voids (2% often gives a satisfactory result) and calculate a soil particle density as follows:

$$\rho_{st} = \frac{100\rho_d}{(100-V_a)-\rho_d w}$$

- where
- $\rho_{st}$  = soil particle density (t/m<sup>3</sup>)
  - $\rho_d$  = dry density of material (t/m<sup>3</sup>)
  - $V_a$  = nominated air voids (%)
  - $w$  = moisture content expressed as a percentage of the mass of dry material

The material's soil particle density so derived is the assumed value.

**Table 1 – Dimensions and tolerances for suitable moulds and rammer**

Apparatus	Dimension	Tolerance
<b>Moulds</b>		
Mould A: 105 diameter		
Internal diameter (mm)	105.0	± 0.5 *
Effective height (mm)	115.5	± 0.5 *
Nominal volume (cm <sup>3</sup> )	1000	± 15
Mould B: 152 mm diameter		
Internal diameter (mm)	152.0	± 1.0 *
Effective height (mm)	132.5	± 0.5 *
Nominal volume (cm <sup>3</sup> )	2400	± 35



Apparatus	Dimension	Tolerance
<b>Rammer</b>		
Diameter; round foot (mm)	50	± 0.4
Area of rammer (mm <sup>2</sup> )	1964	± 31
Drop (mm)	450	± 2.0 ‡
Mass (kg)	4.9	± 0.01 ‡
Energy delivered per blow (J)	21.62	± 0.08
Number of layers: Mould A	5	
Mould B	3	
Number of blows/layer: Mould A	25	
Mould B	100	
Energy input (kJ/m <sup>3</sup> )	2703	± 60

\* Either but not both of the tolerances may be exceeded provided the specified tolerance on volume is not exceeded.

‡ Either but not both of the tolerances may be exceeded provided the appropriate tolerance on energy delivered per blow is not exceeded

**Table 2 – Size fraction and mould size**

Percentage retained		Test mould	Portion to be tested
37.5 mm sieve	19.0 mm sieve		
> 20	–		Not tested by this method
≤ 20	> 20	B	All material passing 37.5 mm sieve
–	≤ 20	A	All material passing 19.0 mm sieve

**Table 3 – Minimum curing time**

Plasticity	Condition of prepared sample	
	Sample moisture content within OMC ± 2%	Sample moisture content outside OMC ± 2%
Sands and granular material*	2 h	2 h
Low (LL ≤ 35%)	24 h	48 h
Medium (35 < LL ≤ 50%)	48 h	96 h (4 days)
High (LL > 50%)	96 h (4 days)	168 h (7 days)

\* These can include naturally occurring sands and gravels, crushed rocks and manufactured materials with a fines (< 0.075 mm) content typically less than 12% and a liquid limit < 35%.

**Table 4 - Acceptable range of two results expressed as a percentage of mean value**

Precision measure	MDD	OMC
Repeatability	2	10
Reproducibility	4	20

## Test Method Q143: Treatment of oversize material

### 1 Source

This Test Method applies the principles of Section 4(c) of AS 1289.5.4.1: *Soil compaction and density tests – Compaction control test - Dry density ratio, moisture variation and moisture ratio*. It differs from this standard in providing procedural details for the techniques used for determining the oversize volume.

### 2 Scope

This Test Method sets out the procedure for the determination of the mass and percentage of oversize for a material on a dry basis. It assumes that the masses of the oversize and undersize material have been determined by other test methods.

The method provides for the volume of oversize to be measured either by using a measuring cylinder, siphon can or by below balance weighing.

### 3 Apparatus

The following apparatus is required:

The apparatus required for this test depends on the technique used to determine the volume of oversize.

#### 3.1 Measuring cylinder

- a) Measuring cylinder, having a volume exceeding the oversize material under test and with graduations not greater than 5 mL.

#### 3.2 Siphon can

- a) Siphon can of suitable capacity.
- b) Water container, having a volume exceeding the oversize material under test.
- c) Balance of suitable capacity, having a resolution of at least 1 g and with a limit of performance within the range of  $\pm 5$  g.

#### 3.3 Below balance weighing

- a) Balance of suitable capacity equipped for below balance weighing, having a resolution of at least 1 g and with a limit of performance within the range of  $\pm 5$  g.
- b) Balance bench, equipped with a hole for below balance weighing.
- c) Wire basket of suitable capacity to contain the oversize and a thin wire to suspend the basket.
- d) Container equipped with an overflow and of suitable capacity to accommodate the suspended basket.

- 3.4 Drying oven of suitable capacity, having a temperature of 105 - 110°C and conforming to AS 1289.0.

### 4 Procedure

The procedure shall be as follows:

- 4.1 Determine the volume of oversize using either the measuring cylinder, siphon can or below balance weighing technique, using wet oversize material.

## 4.2 Measuring cylinder

- 4.2.1 Place the measuring cylinder on a stable level surface and half fill the measuring cylinder with water.
- 4.2.2 Determine the volume of water in the measuring cylinder ( $V_1$ ).
- 4.2.3 Place the wet oversize material in the measuring cylinder, avoiding any water loss.
- 4.2.4 Determine the volume of water and wet oversize material in the measuring cylinder ( $V_2$ ).

## 4.3 Siphon can

- 4.3.1 Determine the mass of the water container ( $m_1$ ).
- 4.3.2 Place the siphon can on a stable level surface and fill the can with water above the level of the overflow and allow the excess water to run to waste.
- 4.3.3 When water has ceased flowing (dripping), stopper the overflow and place the wet oversize material in the can, avoiding any water loss.
- 4.3.4 Remove the stopper from the overflow and collect the excess water in the container.
- 4.3.5 When the water has ceased flowing (dripping), weigh the container and water ( $m_2$ ).

## 4.4 Below balance weighing

- 4.4.1 Place the container directly below the hole in the balance bench and fill it until water escapes from the overflow and allow the excess water to run to waste.
- 4.4.2 When water has ceased flowing (dripping), suspend the basket from the balance using the thin wire so that the basket is completely immersed in water.
- 4.4.3 When the water has ceased flowing (dripping), record the mass of the basket immersed in water ( $m_3$ ).
- 4.4.4 Transfer the wet oversize to the basket and agitate the basket to remove any entrapped air from the oversize.
- 4.4.5 Add additional water if necessary until water escapes from the overflow and allow the excess water to run to waste.
- 4.4.6 When the water has ceased flowing (dripping), record the mass of the oversize and basket ( $m_4$ ).

## 4.5 Oven drying

- 4.5.1 If the dry mass of the oversize is not known, oven dry the oversize to a constant mass ( $m_{od}$ ).

## 5 Calculations

Calculations shall be as follows:

- 5.1 The volume of oversize as follows:

For the measuring cylinder technique:

$$V_o = V_2 - V_1$$

where  $V_o$  = volume of oversize (cm<sup>3</sup>)  
 $V_1$  = volume of water in the measuring cylinder (mL)

$V_2$  = volume of water and wet oversize material in the measuring cylinder (mL)

For the siphon can technique:

$$V_o = m_2 - m_1$$

where  $V_o$  = volume of oversize (cm<sup>3</sup>)  
 $m_2$  = mass of container and water (g)  
 $m_1$  = mass of container (g)

For the below balance weighing technique:

$$V_o = m_{ow} - (m_4 - m_3)$$

where  $V_o$  = volume of oversize (cm<sup>3</sup>)  
 $m_{ow}$  = wet mass of oversize material (g), obtained from Q142A or Q142B  
 $m_4$  = mass of fully immersed basket and oversize (g)  
 $m_3$  = mass of fully immersed basket (g)

5.2 Determine the percentage of oversize as follows:

5.2.1 Where the undersize is not dry, use the wet mass of material ( $m_w$ ), wet mass of oversize ( $m_{ow}$ ) and moisture content of undersize material ( $w_u$ ) obtained from Test Method Q142A or Q142B to calculate the dry mass of undersize ( $m_{ud}$ ) as follows:

$$m_{ud} = \frac{100(m_w - m_{ow})}{100 + w_u}$$

where  $m_{ud}$  = dry mass of undersize material (g)  
 $m_w$  = wet mass of material (g)  
 $m_{ow}$  = wet mass of oversize material (g)  
 $w_u$  = moisture content of undersize material (%)

5.2.2 Determine the percentage of oversize as follows

$$P_{od} = \frac{100m_{od}}{m_{od} + m_{ud}}$$

where  $P_{od}$  = percentage of oversize (dry basis)  
 $m_{od}$  = dry mass of oversize (g)  
 $m_{ud}$  = dry mass of undersize (g) (Note 7.1), obtained from Q142A or Q142B

## 6 Reporting

The following shall be reported:

- 6.1 The percentage oversize to the nearest 1%, and.
- 6.2 The number of this test method, that is Q143.

## Test Method Q144A: Assignment of maximum dry density and optimum moisture content for soils and crushed rock

### 1 Source

This Test Method is based on AS 1289.5.4.2: *Soil compaction and density tests – Compaction control test - Assignment of maximum dry density and optimum moisture content values.*

### 2 Scope

This Test Method sets out the procedure for assigning values of MDD and OMC. Where oversize is present, the adjusted MDD and OMC will be calculated.

The Test Method is usually applicable to essentially uniform materials and is usually confined to pavement materials produced under controlled conditions, such as unbound materials from quarries or plant-mixed stabilised materials. It may be applicable to in situ stabilised materials where the insitu material is essentially uniform or where additional imported material is majority of material to be stabilised.

### 3 Procedure

The procedure for determining assigned values shall be as follows:

#### 3.1 For quarry materials only:

3.1.1 Obtain six samples of uncompacted material, in accordance with Test Method AS 1141.3.1, from a stockpiled lot of at least 250 tonnes. Number each sample and any subsequent sample in chronological order with a sample number at the time of sampling.

#### 3.2 For plant-mixed stabilised materials other than foamed bitumen:

3.2.1 Obtain six samples of uncompacted material, in accordance with Test Method AS 1141.3.1, from a stockpiled lot or daily production of material without additive of at least 250 tonnes. Obtain samples of additives to be used in production. Number each sample and any subsequent sample in chronological order with a sample number at the time of sampling.

#### 3.3 For plant-mixed foamed bitumen stabilised materials:

3.3.1 Obtain six samples of processed material, in accordance with Test Method AS 1141.3.1. Number each sample and any subsequent sample in chronological order with a sample number at the time of sampling.

#### 3.4 For insitu stabilised materials excluding granular stabilisation:

3.4.1 Obtain six samples of uncompacted material after spreading and the incorporation of all stabilising agent, but before the start of compaction, in accordance with Section 6 of Test Method Q061. Number each sample and any subsequent sample in chronological order with a sample number at the time of sampling.

#### 3.5 For granular stabilisation:

3.5.1 Obtain six samples of compacted material, in accordance with Section 5 of Test Method Q061. Number each sample and any subsequent sample in chronological order with a sample number at the time of sampling.

#### 3.6 Test each sample separately and determine the following:

3.6.1 MDD and OMC in accordance with Test Method Q142A or Q142B as appropriate.

3.6.2 Mass, volume and percentage oversize in accordance with Test Method Q143.

#### **4 Calculations**

Calculations shall be as follows:

- 4.1 For each sample determine the adjusted MDD and adjusted OMC using the calculation in Test Method Q140A Steps 5.1 and 5.2.
- 4.2 From each set of six test results, calculate the mean values for the adjusted MDD and adjusted OMC.
- 4.3 Compare the adjusted MDD and adjusted OMC values for each of the six samples to the calculated mean for that property as follows:
  - 4.3.1 If no results obtained for a property from the six samples differ from the mean by more than the limits shown in Table 1 for that property. Designate the mean value for that property as calculated in Step 4.2 as the assigned MDD or assigned OMC, as appropriate (Note 7.1).
  - 4.3.2 If any single result obtained for a property from the six samples differs from the calculated mean for that property by more than the limits shown in Table 1, the determined mean values shall not be assigned for either property for the set of samples. Either obtain and test six further samples in accordance with Section 3 or undertake one-for-one testing in accordance with Test Method Q140A.

#### **5 Assigned values check**

The procedure for checking assigned values and reassigning shall be performed as follows:

- 5.1 Monitor the assigned values by sampling and testing as detailed in Section 3, in accordance with the following frequencies:
  - 5.1.1 Quarry materials and plant-mixed stabilised materials are to be checked by obtaining at least one sample at the following frequency:
    - a) after the supply of not more than 10,000 tonnes of material
    - b) if the assigned values have not been used for 2 months or more, or
    - c) if the assigned values have not been used on the project being tested.
  - 5.1.2 Insitu stabilised materials are to be checked by obtaining at least one sample from every lot.
- 5.2 Add the new data to the previous data while removing an equal number of existing and consecutive values commencing at the lowest sample number.
- 5.3 Calculate new mean values for each property and review the MDD and optimum moisture content data in accordance with Section 4.
- 5.4 If the criteria in Table 1 are not infringed, report reassigned values for MDD and OMC (Note 7.1).
- 5.5 Should the criteria of Table 1 now be infringed:
  - 5.5.1 For quarry materials only:
    - a) either re-determine the assigned values by obtaining and testing six further samples in accordance with Section 3 or undertake one-for-one testing in accordance with Test Method Q140A.

5.5.2 For plant-mixed stabilised materials other than foamed bitumen:

- a) continue using the assigned MDD, OMC as determined in Section 4 for the remainder of the lot
- b) for subsequent lots either re-determine the assigned values by obtaining and testing six further samples in accordance with Section 3 from the next lot or undertake one-for-one testing in accordance with Test Method Q140A.

5.5.3 For plant-mixed foamed bitumen stabilised materials:

- a) continue using the assigned MDD, OMC as determined in Section 4 for the remainder of the lot
- b) for subsequent lots either re-determine the assigned values by obtaining and testing six further samples in accordance with Section 3 from the next lot or undertake one-for-one testing in accordance with Test Method Q140A.

5.5.4 For insitu stabilised materials:

- a) continue using the assigned MDD, OMC as determined in Section 4 for the remainder of the lot
- b) for subsequent lots either re-determine the assigned values by obtaining and testing six further samples in accordance with Section 3 from the next lot or undertake one-for-one testing in accordance with Test Method Q140A.

## 6 Reporting

The following shall be reported:

6.1 Test Results:

- a) The assigned value of MDD to the nearest 0.01 t/m<sup>3</sup>.
- b) The assigned value of OMC to the nearest 0.5%.
- c) Compaction standard used, that is, standard or modified.

6.2 The date at which the values were assigned and the sample numbers corresponding to the data sets used.

6.3 The number of this test method, that is Q144A.

## 7 Notes on method

7.1 Control charts of the progressively assigned values may be plotted to assess whether there is drift in the values being used, and if so, new values may need to be assigned.

**Table 1 – Limits for assigning MDD and OMC**

Property	Unit	Range	Limits
MDD	t/m <sup>3</sup>	All values	± 0.05
OMC	%	2.0 to 10.0	± 1.0
		10.1 to 15.0	± 1.5
		> 15.0	± 2.0

## Test Method Q145A: Laboratory compaction to nominated levels of dry density and moisture content

### 1 Source

This Test Method was developed in-house using techniques evolved through internal departmental research investigations.

### 2 Scope

This Test Method describes the procedure for compacting specimens to a target dry density and target moisture content when specimens are required by a reference test method for further testing. The target dry density and/or moisture content are related to a nominated percentage of the MDD and/or OMC, DoS or density index respectively.

The Test Method relies on the reference method to provide essential procedural information such as apparatus and compaction details.

### 3 Definitions

For this Test Method, the following definitions shall apply:

- 3.1 Relative compaction - ratio of dry density to MDD expressed as a percentage.
- 3.2 Relative moisture content - ratio of moisture content to OMC expressed as a percentage.

### 4 Apparatus

The following apparatus is required:

- 4.1 Refer to the apparatus section of the reference method for details of mould and baseplate, rammer or mechanical compactor, material height gauge and collar and/or spacer.
- 4.2 Balance of suitable capacity, having a resolution of at least 1 g and with a limit of performance within the range of  $\pm 5$  g.
- 4.3 Levelling plate, having a height of at least 20 mm and a diameter of 151 mm.
- 4.4 Rubber mallet.
- 4.5 Level and rigid foundation upon which to compact the specimen, for example, a 100 mm thick sound concrete floor or a concrete block of at least 100 kg mass.
- 4.6 Straightedge, made of steel and having the approximate dimensions of length 250 mm, width 25 mm and thickness 3 mm, preferably with a bevelled edge.
- 4.7 Mixing apparatus, such as a tray, trowel or scoop and water sprayer.
- 4.8 Tool for scarifying each compacted layer, such as a trowel or spatula.

### 5 Materials

The following material is required:

- 5.1 Mould oil, a light mould oil such as Caltex Mould Oil 20 (Note 10.1).



## 6 Calculation of target compaction values

Calculation of target compaction values shall be as follows:

6.1 Calculate target dry density if specified as a nominated relative compaction as follows:

$$\rho_t = \rho_{dm} \frac{RC_n}{100}$$

where  $\rho_t$  = target dry density (t/m<sup>3</sup>)  
MDD = maximum dry density (t/m<sup>3</sup>)  
 $RC_n$  = nominated relative compaction (%)

6.2 Calculate target dry density if specified as nominated density index as follows:

$$\rho_t = \frac{-100\rho_{d\ max}\rho_{d\ min}}{I_{Dn}\rho_{d\ max} - I_{Dn}\rho_{d\ min} - 100\rho_{d\ max}}$$

where  $\rho_t$  = target dry density (t/m<sup>3</sup>)  
 $\rho_{d\ max}$  = maximum dry density of the soil (t/m<sup>3</sup>)  
 $\rho_{d\ min}$  = minimum dry density of the soil (t/m<sup>3</sup>)  
 $I_{Dn}$  = nominated density index (%)

6.3 Calculate the target compaction moisture content, if specified, as a nominated relative moisture content as follows:

$$w_t = w_o \frac{RM_n}{100}$$

where  $w_t$  = target moisture content (%)  
 $w_o$  = optimum moisture content (%)  
 $RM_n$  = nominated relative moisture content (%)

6.4 Calculate the target moisture content if specified, as a nominated DoS as follows:

$$w_t = S_{rn} \left( \frac{\rho_w}{\rho_t} - \frac{1}{\rho_s} \right)$$

where  $w_t$  = target moisture content (%)  
 $S_{rn}$  = nominated DoS (%)  
 $\rho_w$  = water density (t/m<sup>3</sup>) (taken as 1.000 t/m<sup>3</sup>)  
 $\rho_t$  = target dry density (t/m<sup>3</sup>)  
 $\rho_{st}$  = soil particle density (t/m<sup>3</sup>), obtained from AS 1289.3.5.1

## 7 Calculation of mass of material per layer

Calculation of mass of material per layer shall be as follows:

- 7.1 Calculate the required mass of mixed and cured/conditioned wet material per layer as follows:

$$M_1 = \frac{V \rho_t (100 + w_t)}{100 N}$$

where	$M_1$	=	mass of wet material per layer (g)
	$V$	=	mould volume (cm <sup>3</sup> )
	$\rho_t$	=	target dry density (t/m <sup>3</sup> )
	$w_t$	=	target moisture content (%)
	$N$	=	number of layers.

## 8 Procedure

The procedure shall be as follows:

- 8.1 Clean and assemble the mould and baseplate, lightly oiling the internal surfaces. Inspect and clean the rammer or mechanical compactor and ensure that it is free in the guide.
- 8.2 Determine the mass ( $m_1$ ) of the mould and baseplate, attach the collar and place the assembly on a rigid foundation.
- 8.3 At the end of the required curing/conditioning period, spread the test portion on the mixing tray and thoroughly remix. Take a subsample and determine the achieved compaction moisture content ( $w_a$ ) in accordance with Test Method AS 1289.2.1.1.
- 8.4 Weigh out the required mass of wet material for a layer and evenly distribute the material within the mould (Note 10.2).
- 8.5 Compact the material to the required height using only rammer blows effected from the complete drop of the rammer. Distribute the blows uniformly over the layer surface. As the required layer height is approached, it may be necessary to use partial blows. Scarify each compacted layer to promote bonding and interlock between layers.
- 8.6 Repeat Steps 8.4 to 8.5 for each subsequent layer with the final layer being compacted until its height is approximately 1 - 2 mm greater than the required height.
- 8.7 Level the final layer by lightly scarifying the surface if necessary and redistributing the loose material.
- 8.8 Place a suitable levelling plate on the surface and use the rammer or a rubber mallet to further compact the layer until the required height is reached.
- 8.9 Remove the levelling plate together with any collar and/or spacer.
- 8.10 Determine the mass ( $m_2$ ) of the mould, baseplate and compacted material.
- 8.11 If more than one specimen is required, for example UCS specimens, repeat Steps 8.4 to 8.10 to compact additional specimens.

## 9 Calculations

Calculations shall be as follows:

9.1 Calculate the achieved dry density as follows:

$$\rho_a = \frac{100(m_2 - m_1)}{V(100 + w_a)}$$

where  $\rho_a$  = achieved dry density (t/m<sup>3</sup>)  
 $m_2$  = mass of mould, baseplate and compacted material (g)  
 $m_1$  = mass of mould and baseplate (g)  
 $V$  = volume of mould (cm<sup>3</sup>)  
 $w_a$  = achieved moisture content (%)

9.2 When the target dry density is specified as a nominated relative compaction, calculate the achieved relative compaction as follows:

$$RC_a = \frac{\rho_a 100}{\rho_{dm}}$$

where  $RC_a$  = achieved relative compaction (%)  
 $\rho_a$  = achieved compacted dry density (t/m<sup>3</sup>)  
 $\rho_{dm}$  = maximum dry density (t/m<sup>3</sup>)

9.3 When the target dry density is specified as density index, calculate the achieved density index as follows:

$$I_{Da} = \frac{\rho_{d \max}(\rho_a - \rho_{d \min})100}{\rho_a(\rho_{d \max} - \rho_{d \min})}$$

where  $I_{Da}$  = achieved density index (%)  
 $\rho_{d \max}$  = maximum dry density of the soil (t/m<sup>3</sup>)  
 $\rho_a$  = achieved dry density (t/m<sup>3</sup>)  
 $\rho_{d \min}$  = minimum dry density of the soil (t/m<sup>3</sup>)

9.4 When the target compaction moisture content is specified as a nominated relative moisture content, calculate the achieved relative moisture content as follows:

$$RM_a = \frac{w_a 100}{w_o}$$

where  $RM_a$  = achieved relative moisture content (%)  
 $w_a$  = achieved compaction moisture content (%)  
 $w_o$  = optimum moisture content (%)

9.5 When the target moisture content is specified as DoS, calculate the achieved DoS as follows:

$$S_{ra} = \frac{w_a}{\frac{\rho_w}{\rho_a} - \frac{1}{\rho_s}}$$

- where
- $S_{ra}$  = achieved DoS (%)
  - $w_a$  = achieved moisture content (%)
  - $\rho_w$  = water density (t/m<sup>3</sup>) (taken as 1.000 t/m<sup>3</sup>)
  - $\rho_a$  = achieved dry density (t/m<sup>3</sup>)
  - $\rho_s$  = soil particle density (t/m<sup>3</sup>)

## 10 Reporting

The following shall be reported:

10.1 Nominated values as follows:

- a) Nominated relative compaction to the nearest 0.5%.
- b) Nominated relative moisture content to the nearest 1%.
- c) Nominated DoS to the nearest 1%.
- d) Nominated density index to the nearest 1%.

10.2 Target values as follows:

- a) Target dry density to the nearest 0.01 t/m<sup>3</sup>.
- b) Target moisture content to the nearest 0.1%.

10.3 Achieved values as follows:

- a) Achieved moisture content to the nearest 0.1%.
- b) Achieved dry density to the nearest 0.01 t/m<sup>3</sup>.
- c) Achieved relative compaction to the nearest 0.5%.
- d) Achieved relative moisture content to the nearest 1%.
- e) Achieved density index to the nearest 1%.
- f) Achieved DoS to the nearest 1%.

10.4 The number of this Test Method, that is Q145A.

## 11 Notes on method

11.1 Before handling oil, the operator should consult the relevant SDS.

11.2 When compacting multiple specimens from the same test portion, it is preferable that these are moulded simultaneously. This is accomplished by compacting the same layer in each mould one after the other.

11.3 Where simultaneous compaction is used, Steps 8.4 and 8.5 are performed on the same layer of each mould one after the other before moving to the next layer in Step 8.6.

## Test Method Q146: Degree of saturation of soils and crushed rock

### 1 Source

This Test Method was developed in-house using information contained within technical references.

### 2 Scope

This Test Method describes the procedure for determining the degree of saturation of compacted layers of pavements consisting of unbound materials.

### 3 Procedure

The procedure shall be as follows:

- 3.1 Use random stratified sampling to determine test locations in accordance with the requirements of the specification, sampling plan or testing methodology as appropriate.
- 3.2 Determine the compacted dry density and the insitu moisture content of the compacted pavement material in accordance with Test Method Q141A preferably, or Q141B. When the compacted dry density and the insitu moisture content of the compacted pavement material is determined in accordance with Test Method Q141A, a material wet density bias and a material moisture bias must always be determined and used to adjust the nuclear gauge wet density and moisture content respectively (Note 6.1).
- 3.3 Determine the soil particle density of the pavement material in accordance with Test Method AS 1289.3.5.1, determining new value at the following frequency:
  - 3.3.1 Where an assigned MDD applies, obtain a sample at the following frequency:
    - a) after the supply of not more than 10,000 tonnes of material
    - b) if the soil particle density has not been used for two months or more, or
    - c) if the soil particle density has not been used on the project being tested.
  - 3.3.2 Where one-for-one testing for MDD applies, obtain at least one sample from every lot (Note 6.21).
- 3.4 Determine the DoS as described in Section 4.
- 3.5 Where the DoS has necessitated further drying of the pavement material, retest to determine the compacted dry density and insitu moisture content in accordance with Steps 3.1 to 3.2.

## 4 Calculations

Calculations shall be as follows:

4.1 Calculate the DoS as follows:

$$S_r = \frac{w_f}{\frac{\rho_w}{\rho_d} - \frac{1}{\rho_s}}$$

- where
- $S_r$  = degree of saturation (%)
  - $w_f$  = insitu moisture content (%)
  - $\rho_w$  = water density (t/m<sup>3</sup>) (taken as 1.000 t/m<sup>3</sup>)
  - $\rho_d$  = compacted dry density (t/m<sup>3</sup>)
  - $\rho_s$  = soil particle density (t/m<sup>3</sup>)

4.2 Where tests have been performed on a lot, calculate the maximum characteristic DoS in accordance with Test Method Q020.

## 5 Reporting

The following shall be reported:

5.1 DoS to the nearest 2%.

5.2 Soil particle density:

- a) Soil particle density to the nearest 0.01 t/m<sup>3</sup>
- b) Date soil particle density determined

5.3 If required, the maximum characteristic DoS in accordance with Test Method Q020.

5.4 The number of this Test Method, that is Q146.

## 6 Notes on method

6.1 Refer to *Nuclear Gauge Testing Manual* Test Method N01 for details.

6.2 Where one-for-one testing is undertaken on variable materials, a higher sampling frequency may be required to produce reliable DoS results. It may be necessary to sample for soil particle density at each test location.

## Test Method Q147B: Compacted density of stabilised material - vacuum saturation

### 1 Source

This Test Method applies the principles of ASTM C642: *Standard test method for density, absorption and voids in hardened concrete* to the determination of the compacted density of stabilised specimens.

### 2 Scope

This Test Method describes a procedure for determining the compacted density of stabilised specimens. The specimens may be either laboratory or field compacted. The Test Method is also applicable to cores removed from stabilised materials.

### 3 Apparatus

The following apparatus is required:

- 3.1 Balance, of suitable capacity, with a resolution of at least 0.1 g and with a limit of performance within the range of  $\pm 0.5$  g. The balance shall also be capable of below balance weighing.
- 3.2 Balance bench, equipped with a hole for below balance weighing.
- 3.3 Thermometer, a partial or total immersion thermometer or other suitable temperature measuring device having a temperature range which includes the test temperature, and graduated to 1°C or less with an uncertainty of no more than 0.5°C.
- 3.4 Attachment, a non-absorbent device to suspend the specimen (for example, nylon or wire loop, wire support frame).
- 3.5 Water container, fitted with an overflow and of suitable dimensions to allow the specimen to be completely immersed without contacting any part of the container.
- 3.6 Water container, of sufficient volume to contain the specimen.
- 3.7 Oven, of suitable capacity, having a temperature of 105 – 110°C and conforming to AS 1289.0.
- 3.8 A vacuum apparatus and chamber.
- 3.9 Container for soaking specimens.
- 3.10 Tray for drying specimens.

### 4 Materials

The following materials are required:

- 4.1 Potable water.
- 4.2 Cloths for removing excess water from vacuum soaked specimens.

### 5 Procedure

The procedure shall be as follows:

## 5.1 Sample preparation

- 5.1.1 Where the specimen is a core, prepare the core specimen in accordance with Q303A Subsection 4.2 or AS 2891.1.2 Clause 8, without air-drying to obtain specimens about 63.5 mm in height for testing.
- 5.1.2 Determine the mass of the specimen ( $m_1$ ).
- 5.1.3 Place the specimen in a container and cover with potable water at  $23 \pm 3.0^\circ\text{C}$ . Place in the vacuum chamber and apply a partial vacuum of 13 kPa or less absolute pressure for 10 minutes (Note 8.1).
- 5.1.4 After the vacuum soaking remove the specimens from the water and carefully remove excess water using a cloth.
- 5.1.5 Determine the mass of the saturated-surface-dry specimen ( $m_2$ ).

## 5.2 Density measurement

- 5.2.1 Place the container directly below the hole in the balance bench, fill it until water escapes from the overflow and allow the excess water to run to waste.
- 5.2.2 When water has ceased dripping from the overflow, fit the attachment to the balance, allow the remainder of the attachment to be immersed in the water container, and zero the balance.
- 5.2.3 Using the attachment, suspend the specimen from the balance and gently lower it into the water container until completely immersed, taking care to ensure that the suspended specimen hangs free of the sides and bottom of the container.
- 5.2.4 Add additional water if necessary until water escapes from the overflow, and allow the excess water to run to waste.
- 5.2.5 When water has ceased dripping from the overflow, determine the mass of the immersed specimen ( $m_3$ ).
- 5.2.6 Record the temperature of the water in the container to the nearest  $1^\circ\text{C}$ .

## 5.3 Drying of specimen

- 5.3.1 Determine the mass of the drying tray ( $m_4$ ).
- 5.3.2 Remove the specimen from the water and place in the drying tray. Place the specimen and drying tray in an oven and dry to constant mass.
- 5.4 Determine the mass of the drying tray and dry specimen ( $m_5$ ).

## 6 Calculations

Calculations shall be as follows:

- 6.1 Calculate the compacted dry density of the specimen as follows:

$$\rho_d = \frac{m_5 - m_4}{m_2 - m_3} \rho_w$$

- where
- $\rho_d$  = compacted dry density of specimen ( $\text{t/m}^3$ )
  - $m_5$  = mass of dry specimen and tray (g)
  - $m_4$  = mass of tray (g)
  - $m_2$  = mass of saturated-surface-dry specimen (g)
  - $m_3$  = mass of immersed specimen (g)



$\rho_w$  = density of water at test temperature (t/m<sup>3</sup>) (Table 1)

6.2 Calculate the moisture content as follows:

$$w = \frac{m_1 - (m_5 - m_4)}{m_5 - m_4} 100$$

where  $w$  = moisture content of specimen (%)

$m_1$  = mass of specimen (g)

$m_5$  = mass of dry specimen and tray (g)

$m_4$  = mass of tray (g)

## 7 Reporting

The following shall be reported:

7.1 Compacted dry density to the nearest 0.01 t/m<sup>3</sup>.

7.2 Moisture content to the nearest 0.1%, and.

7.3 The number of this Test Method, that is Q147B.

## 8 Notes on method

8.1 A partial vacuum of 13 kPa absolute pressure is approximately equivalent to a -88 kPa reading on a vacuum gauge at sea level.

**Table 1 - Density of water**

Temperature (°C)	Density (t/m <sup>3</sup> )	Temperature (°C)	Density (t/m <sup>3</sup> )	Temperature (°C)	Density (t/m <sup>3</sup> )
0	1.000	14	0.999	28	0.996
1	1.000	15	0.999	29	0.996
2	1.000	16	0.999	30	0.996
3	1.000	17	0.999	31	0.995
4	1.000	18	0.999	32	0.995
5	1.000	19	0.998	33	0.995
6	1.000	20	0.998	34	0.994
7	1.000	21	0.998	35	0.994
8	1.000	22	0.998	36	0.994
9	1.000	23	0.998	37	0.993
10	1.000	24	0.997	38	0.993
11	1.000	25	0.997	39	0.993
12	1.000	26	0.997	40	0.992
13	0.999	27	0.997		

## Test Method Q148: Manufacture of laboratory slab specimens – segmental wheel compactor

### 1 Source

This Test Method was developed in-house but applies the principles of Austroads Asphalt Test AST 05-1999: *Sample Preparation – Compaction of Asphalt Slabs Suitable for Characterisation to granular materials*.

### 2 Scope

This Test Method describes the procedure for the laboratory manufacture using a segmental wheel compactor for wheel tracker testing of slab specimens of soils, crushed rock and recycled material blends which have been either modified or stabilised with a stabilising agent or are in their natural state.

### 3 Apparatus

Example of sample divider (riffle) is contained in AS 1141.2 Figure 1.

The following apparatus is required:

#### 3.1 Segmental wheel compactor, comprising the following (Note 10.1):

- a) Compaction device, capable of applying a loading of 1000 to 30,000 N to within 500 N, with the option for vibratory compaction and sufficiently rigid that it will not deform under load over the operating range. The compaction device will be in the form of a freely rotating wheel segment of diameter  $1200 \pm 200$  mm. The foot of the compaction device having an arc length of 300 mm and a width of 300 mm. The compaction foot needs to be vertically moveable and set to a specified height above the base of the compaction mould using a setting block.
- b) Compaction table, having an oscillating speed of 10 to 25 oscillations per minute adjustable to within 1 oscillation per minute, and a travel of 200 to 450 mm adjustable to within 5 mm. The table will have provision to attach the compaction mould.
- c) Compaction moulds, metal moulds of internal dimensions 300 mm length, 300 mm width and 100 mm height with detachable sides and baseplate. A 55 mm detachable collar can be fitted to the top of the mould to accommodate material prior to compaction. A base plate of dimensions 317 mm length and 317 mm width can be fitted to facilitate locking of the mould into the slab compactor.
- d) Lifting device, to move a compaction mould (with or without material) to and from the compaction table.

#### 3.2 Sieves, 19.0 mm and 9.50 mm conforming to ISO 3310.

#### 3.3 Miscellaneous mixing apparatus, such as:

- a) a tray, trowel or scoop suitable for hand mixing material, or
- b) sample divider (riffle), conforming to the requirements of AS 1141.2 for riffle mixing of material.

#### 3.4 Balance, of suitable capacity, with a resolution of at least 1 g and with a limit of performance within the range of $\pm 5$ g.

#### 3.5 Tool for scarifying each compacted layer and screeding the uncompacted material, such as a trowel or spatula.

## 4 Materials

The following material is required:

- 4.1 Mould oil, a light mould oil such as Caltex Mould Oil 20 (Note 10.2).
- 4.2 Grease proof paper, such as baking paper, cut into two 300 mm squares.

## 5 Sample preparation

The sample shall be prepared as follows:

- 5.1 Prepare the bulk sample in accordance with Section 4 of Test Method Q101 to produce a representative subsample of at least 100 kg.
- 5.2 Further prepare the material by screening the subsample on a 19.0 mm sieve in accordance with Test Method Q101, Steps 5.2.1 to 5.2.3. Ensure that any aggregations are broken up to pass a 9.50 mm sieve, any oversize material is retained and thoroughly remix the material passing the 19.0mm sieve.
  - 5.2.1 Where oversize is retained on the 19.0 mm sieve, determine its mass ( $m_{ow}$ ) and the mass of the passing 37.5 mm (undersize) material ( $m_{uw}$ ). Calculate the percentage oversize on a wet mass basis as follows:

$$P_{ow} = \frac{100m_{ow}}{m_{ow} + m_{uw}}$$

where  $P_{ow}$  = percentage by wet mass of oversize

$m_{ow}$  = wet mass of oversize (g)

$m_{uw}$  = wet mass of undersize (g)

- 5.3 Discard any material retained on the 19.0 mm sieve.
- 5.4 Prepare representative test portions of the sieved material in accordance with Test Method Q101, Steps 5.2.4 to 5.2.5 as follows:
  - a) two test portions of 13,000 g for slab compaction
  - b) test portion for hygroscopic moisture content
  - c) test portion for soil particle density, and
  - d) four or more test portions to determine the OMC and MDD.
- 5.5 Determine the mass of each portion ( $m_1$ ) prepared in Step 5.4 a)
- 5.6 Determine the hygroscopic moisture content ( $w_1$ ) of the test portion prepared in Step 5.4 b) in accordance with Test Method AS 1289.2.1.1.

## 6 Preparation of test portions

Test portions of slab compaction shall be prepared as follows:

### 6.1 Materials with stabilising agents other than foamed bitumen

- 6.1.1 Determine the OMC and MDD of the test portion prepared in Step 5.4 d) in accordance with Test Methods Q142A or Q142B as appropriate, using a Type A mould and incorporating the specified stabilising agents.

- 6.1.2 Calculate the target moisture content ( $w_t$ ) and target dry density to achieve either the nominated relative compaction and nominated relative moisture content or the nominated relative compaction and nominated DoS in accordance with Test Method Q145A.
- 6.1.3 Determine the quantity of stabilising agent, then mix and condition each of the two test portions for slab compaction in accordance with Test Method Q135A.

## **6.2 Materials with foamed bitumen**

- 6.2.1 Determine the OMC and MDD of the test portion prepared in Step 5.4 d) in accordance with Test Methods Q142A or Q142B as appropriate, using a Type A mould.
- 6.2.2 Calculate the target moisture content ( $w_t$ ) and target dry density to achieve either the nominated relative compaction and nominated relative moisture content or the nominated relative compaction and nominated DoS in accordance with Test Method Q145A.
- 6.2.3 Determine the quantity of stabilising agent, then mix and condition each of the two test portions for slab compaction in accordance with Test Method Q254A.

## **6.3 Materials without stabilising agent**

- 6.3.1 Determine the OMC and MDD of the test portion prepared in Step 5.4 d) in accordance with Test Methods Q142A or Q142B as appropriate, using a Type A mould and using the specified curing time for the material in Test Method Q255 Table 1.
- 6.3.2 Determine the soil particle density ( $\rho_{st}$ ) of the test portion prepared in Step 5.4 c) in accordance with Test Method AS 1289.3.5.1.
- 6.3.3 Calculate the target moisture content ( $w_t$ ) and target dry density to achieve either the nominated relative compaction and nominated relative moisture content or the nominated relative compaction and nominated DoS in accordance with Test Method Q145A.
- 6.3.4 Calculate the dry mass of each test portion ( $m_2$ ) and mass of mixing water to be added ( $m_3$ ), then mix and cure each test portion in accordance with Test Method Q255.

## **7 Slab specimen compaction**

The slab specimen shall be compacted as follows:

- 7.1 Calculate the mass of wet material per layer in accordance with Test Method Q145A.
- 7.2 Assemble the mould and detachable base plate.
- 7.3 Determine the mass ( $m_1$ ) of the mould and base plate. Attach the collar and fix the collar to the mould and, if required, lightly oil the internal surfaces to prevent material adhering to the mould.
- 7.4 At the end of the required curing / conditioning period, thoroughly remix the test portion by hand or riffle. Take a subsample and determine the achieved moisture content ( $w_a$ ) in accordance with Test Method AS 1289.2.1.1.
- 7.5 Insert the 50 mm height setting block into the slab compactor to set the thickness of the slab specimen.
- 7.6 Transfer the cured test portion to the mould, screed it flat without segregation using a trowel and level the material.
- 7.7 Place a piece of grease proof paper on the levelled material.
- 7.8 Apply sufficient air pressure to raise the compaction foot and transfer the mould and sample to the compaction table using the lifting device.

- 7.9 Fix the mould to the compaction table.
- 7.10 Move the compaction table until the compaction foot is aligned with the inside edge of the mould collar.
- 7.11 Set the pressure to 25 kPa and lower the compaction foot to rest on the material in the mould.
- 7.12 Compact the sample in the mould using the manufacturer's instructions to provide the following compaction sequence:
  - a) 5 oscillations at a pressure of 25 kPa
  - b) 5 oscillations at a pressure of 50 kPa
  - c) 10 oscillations at a pressure of 100 kPa
  - d) 10 oscillations at each additional increment of 100 kPa until the target slab thickness is attained across the whole of the slab specimen (Note 10.4) (Note 10.5).
- 7.13 Raise the compaction foot, remove the mould then remove and discard the grease proof paper.
- 7.14 Scarify the top of the compacted material to promote bonding with the overlaying layer.
- 7.15 Transfer the second cured test portion to the mould, screed it flat without segregation using a trowel and level the material.
- 7.16 Remove the 50 mm height setting block. Replace with the 100 mm height setting block and repeat Steps 7.7 to 7.12.
- 7.17 Raise the compaction foot, move the compaction table to the end of its forward cycle and remove the mould.
- 7.18 Remove the collar and grease proof paper.
- 7.19 Determine the mass ( $m_2$ ) of the mould, base plate and specimen.

## 8 Calculations

Calculations shall be as follows:

- 8.1 Using the achieved moisture content, calculate the achieved dry density, achieved relative compaction and, achieved relative moisture content or achieved DoS in accordance with Test Method Q145A.
- 8.2 Compare the achieved dry density and target dry density. If they differ by more than 0.02 t/m<sup>3</sup>, discard the specimen, and repeat the preparation to Q145A for the nominated conditions.
- 8.3 Compare the achieved moisture content and the target moisture content. If they differ by more than 1.0%, discard the specimen, and repeat the preparation to Q145A for the nominated conditions.

## 9 Reporting

The following shall be reported:

- 9.1 The percentage of oversize material retained on 19.0 mm sieve to the nearest 1%.
- 9.2 Moisture/density relationship results:
  - a) MDD to the nearest 0.01 t/m<sup>3</sup>
  - b) OMC to the nearest 0.5%

- 9.3 The following in accordance with Test Method Q145A:
- a) Nominated relative compaction and nominated relative moisture content or nominated DoS
  - b) Target dry density, target moisture content
  - c) Achieved dry density, achieved relative compaction, achieved moisture content and achieved relative moisture content or achieved DoS.
- 9.4 The number of this test method, that is Q148.

## **10 Notes on method**

- 10.1 The BP Slab Compactor satisfies the requirements of the segmental wheel compactor.
- 10.2 Before handling oil, the operator should consult the relevant SDS.
- 10.3 For a material prepared in a moist condition close to OMC, periods up to 2 hours may be adequate. However, if the material contains dry clay, periods of up to 7 days may be required. Thus, longer curing times will be required as the cohesion of a material increases.
- 10.4 Vibratory compaction may be used where it becomes apparent that compaction without vibration will not achieve the target slab thickness.
- 10.5 If the target dry density cannot be achieved, calculate the height of the specimen above the top of the mould at three locations on each side of the mould (in the direction of travel) and recalculate the volume of specimen to determine the achieved dry density and achieved relative compaction.

## Test Method Q149: Deformation of granular material – wheel tracker

### 1 Source

This Test Method was developed in-house but applies the principles of Austroads Asphalt Test AST 01-1999 *Deformation Resistance of Asphalt Mixtures by the Wheel Tracking Test* to granular materials.

### 2 Scope

This Test Method describes the procedure for determining the susceptibility of materials to deformation under load. It involves monitoring the deformation that occurs in a test specimen undergoing simple harmonic motion when bearing a loaded wheel on its surface. The method is applicable to specimens of soils, crushed rock and recycled material blends which have been either modified or stabilised with a stabilising agent or are in their natural state compacted in the laboratory.

### 3 Apparatus

Where appropriate, the working tolerances of apparatus are contained in Table 1.

The following apparatus is required:

#### 3.1 Wheel tracker apparatus comprising the following:

- a) Loaded wheel mechanism, consisting of the following:
  - i. steel wheel fitted with a smooth solid rubber tread of thickness 115 mm and diameter of 202.5 mm and width 50 mm and hardness of 80 IRHD units
  - ii. means of loading the wheel to apply a force of  $700 \pm 20$  N centrally and normal to the top surface of the test specimen, and
  - iii. with vertical play in the loaded wheel mechanism less than 0.25 mm.
- b) wheel tracker table, capable of moving in simple harmonic motion at a frequency of 21 cycles per minute over a travel distance of 250 mm (Note 7.1) and fitted with a means for fixing a test specimen of dimensions up to 305 mm length, 305 mm width and 100 mm thickness to the table
- c) rut depth measurement device, an electronic displacement measuring device having a minimum travel of 20 mm resolution of 0.1 mm
- d) means for continuously recording rut depth measurements at progressive numbers of wheel tracker cycles, and
- e) means for controlling the test specimen temperature to within  $\pm 1^\circ\text{C}$  of the test temperature throughout the test.

### 4 Materials

The following material is required:

#### 4.1 Plastic film, for covering the test specimen.

### 5 Procedure

The procedure shall be as follows:

#### 5.1 Prepare the test specimen in accordance with Test Method Q148.

- 5.2 About one hour before loading the test specimen, turn the wheel tracker unit on and set the test temperature to 30°C and allow the chamber and loaded wheel mechanism and tracker table to equilibrate to the test temperature.
- 5.3 Fix the test specimen to the wheel tracker table.
- 5.4 Cover the test specimen with plastic to minimise moisture loss and condition the test specimen to the test temperature for one hour.
- 5.5 Remove the plastic and lower the loaded wheel to the surface of the test specimen and commence wheel tracking in accordance with the operating instructions for the wheel tracker apparatus.
- 5.6 Obtain a continuous record of the rut depth corresponding to different numbers of wheel tracker cycles.
- 5.7 Continue wheel tracking for a minimum of 5000 cycles (10,000 passes), or until:
  - a) the rut depth is in excess of 15 mm, or
  - b) loose material starts falling into the rut.

## **6 Reporting**

The following shall be reported:

- 6.1 Description of the material.
- 6.2 The type and source of the material.
- 6.3 Rut depth of the material at the completion of the test to the nearest 0.2 mm.
- 6.4 Layer thickness of the material to the nearest 1 mm.
- 6.5 Number of wheel tracker cycles.
- 6.6 The values of rut depth, to the nearest 0.2 mm, for the following cycle counts: 5, 50, 500, 1000, 2000, 3000, 4000 and 5000.
- 6.7 Semi-logarithmic plot of the rut depth (mm) as a function of the wheel tracker cycle number (n).
- 6.8 Test temperature to the nearest 1°C.
- 6.9 Reason for terminating test before specified cycles are completed (if required).
- 6.10 The number of this Test Method, that is Q149.

## **7 Notes on method**

- 7.1 One cycle represents the outward and return passes of the loaded wheel, that is, two passes.



**Table 1 - Dimensions and tolerances for compaction apparatus**

<b>Apparatus</b>	<b>Dimension</b>	<b>Tolerance</b>
<b>Loaded wheel - Rubber tread</b>		
Thickness (mm)	11.5	± 1.5
Width (mm)	50.0	± 1.0
Hardness (IRHD)	80	± 10
<b>Loaded Wheel - Steel and rubber tread</b>		
Diameter (mm)	202.5	± 2.5
Width (mm)	50.0	± 1.0
<b>Wheel tracker table</b>		
Motion frequency (cycles / minute)	21	± 0.2
Travel distance (mm)	250	± 20

## Test Method Q250: Moisture ratio of uncompacted soils and crushed rock

### 1 Source

This Test Method was developed in-house using information contained within technical references.

### 2 Scope

This Test Method describes the procedure for determining the moisture ratio of uncompacted materials. For example, these materials may be from quarry stockpiles, insitu stabilised materials or plant mixed materials.

### 3 Definition

For this Test Method, the following definition shall apply:

- 3.1 Moisture ratio is the ratio of insitu moisture content to the laboratory optimum moisture content expressed as a percentage for uncompacted materials.

### 4 Procedure

The procedure shall be as follows:

#### 4.1 OMC using assigned values

- a) Assign or use previously assigned values of optimum moisture content ( $w_o$ ) and, the sieve on which the oversize was retained (19.0 mm or 37.5 mm).
- b) Where assigned values have either not been developed or are impractical, sample and test for OMC and percentage of oversize in accordance with Step 4.2.

##### 4.1.1 New assigned values

- a) Obtain samples of uncompacted material or stockpiled material and assign values of OMC and percentage of any oversize in accordance with Test Method Q144A.

##### 4.1.2 Previously assigned values

- a) Confirm and monitor the applicability of previously assigned values using the Assigned Values Check procedure in accordance with Test Method Q144A.

#### 4.2 OMC using one-for-one testing

- 4.2.1 Obtain samples of material following the sampling for moisture content (refer to Subsection 4.2).

##### 4.2.2 Determine the OMC and percentage of oversize in accordance with:

- a) Test Method Q142A or Q142B as appropriate for pavements or stabilised materials, or
- b) Test Method AS 1289.5.1.1 or AS 1289.5.2.1 as appropriate for earthworks.

### 4.3 Moisture content

- 4.3.1 Use random stratified sampling to determine test locations in accordance with the requirements of the specification, sampling plan or testing methodology as appropriate.
- 4.3.2 Obtain sample and test for moisture content as follows:
- a) For unbound pavement (quarry) materials:
    - obtain samples of material from stockpile using Test Method AS 1141.3.1.
  - b) For plant mixed stabilised materials excluding foamed bitumen:
    - obtain samples of uncompacted material after spreading but before the start of compaction using Test Method Q061.
  - c) For plant mixed foamed bitumen stabilised materials:
    - obtain samples of material from a production stockpile using Test Method AS 1141.3.1, or
    - obtain samples of uncompacted material after spreading but before the start of compaction using Test Method Q061.
  - d) For in situ stabilised materials:
    - obtain samples of uncompacted material after spreading and the incorporation of all stabilising agents and water, but before the start of compaction using Test Method Q061.
  - e) For earthworks materials excluding stabilised materials:
    - obtain samples of uncompacted material after spreading but before the start of compaction using Test Method Q061.
- 4.3.3 Determine the moisture content of the samples ( $w_f$ ) of a representative portion that includes oversize material, except where technical specifications require oversize to be excluded (Note 7.1), in accordance with Test Method AS 1289.2.1.1 or one of the subsidiary Test Methods AS 1289.2.1.2, AS 1289.2.1.4, AS 1289.2.1.5 or AS 1289.2.1.6 for which a relationship with Test Method AS 1289.2.1.1 has been established and used in accordance with Test Method AS 1289.2.3.1.

## 5 Calculations

Calculations shall be as follows:

5.1 For OMC determined using one for one testing:

5.1.1 Adjust the laboratory OMC for oversize material as follows (Note 7.1 and 7.2):

$$w_r = w_o \frac{100 - P_{od}}{100}$$

- where
- $w_r$  = adjusted laboratory optimum moisture content (%)
  - $w_o$  = optimum moisture content assigned or obtained in the laboratory reference test (%)
  - $P_{od}$  = percentage of oversize (dry basis)

5.1.2 Where there is no oversize present in the material,  $w_r = w_o$ .

5.2 For OMC determined using assigned value:

5.2.1 The assigned OMC is already adjusted for oversize, that is,  $w_r = w_o$ .

5.3 Determine the moisture ratio (uncompacted) as follows:

$$MR_u = \frac{100w_f}{w_r}$$

where  $MR_u$  = moisture ratio (uncompacted) (%)

$w_f$  = insitu moisture content (%)

$w_r$  = adjusted laboratory OMC or assigned OMC (%) (Note 7.1)

## 6 Reporting

The following shall be reported:

6.1 Moisture ratio

- a) Moisture ratio (uncompacted) to the nearest 2%.
- b) Material identifier (Note 7.2), if required.

6.2 Insitu test results:

- a) Insitu moisture content to the nearest 0.1%

6.3 Assigned OMC

- a) Assigned OMC to the nearest 0.5%.
- b) Date when the OMC was assigned.

6.4 One for one OMC

- a) Adjusted OMC to the nearest 0.5%
- b) Percentage of dry oversize to the nearest 1%.
- c) The sieve on which the oversize material is retained (19.0 mm or 37.5 mm).

6.5 The number of this Test Method, that is Q250.

## 7 Notes on method

7.1 Where technical specifications require the oversize to be excluded from the calculation of optimum moisture content and moisture ratio,  $P_{od} = 0$  and  $w_r = w_o$ : for example, Technical Specification MRTS04 *General Earthworks* Clause 15.3 where 'Earth fill with >20%, ≤40% by mass retained on 37.5 mm test sieve, to be placed as embankment material below subgrade level'.

7.2 An additional identifier may be placed alongside the property name, which is, moisture ratio (uncompacted). This is usually nominated in the relevant technical specification. For example, Technical Specification MRTS09 *Plant-Mixed Foamed Bitumen Stabilised Pavements*, uses FSP = feed stockpile and FB for foamed bitumen.

## Test Method Q251A: Preparation and compaction of laboratory mixed stabilised materials

### 1 Source

This Test Method was developed in-house using techniques evolved through internal departmental research investigations.

### 2 Scope

This Test Method describes the procedure to prepare and compact UCS specimens of soils and crushed rock which have been either modified or stabilised with a stabilising agent. The method has application as a laboratory design procedure. In the laboratory, prepare test specimens by compacting passing 19.0 mm material to a nominated dry density and nominated moisture content, in accordance with Test Method Q145A. The test is performed under the following conditions, unless otherwise specified:

- standard compaction
- nominated relative moisture content 100% of OMC, and
- nominated relative compaction 100% of MDD.

### 3 Apparatus

Where appropriate, the working tolerances of apparatus are contained in Tables 1 and 2.

Examples of mould and rammers are contained in AS 1289.5.1.1, Figures 1 and 2 and AS 1289.5.2.1 Figure 2.

The following apparatus is required:

- 3.1 Mould assembly (Mould A), comprising a cylindrical metal mould having an internal diameter of 105 mm and an effective height of 115.5 mm, fitted with a detachable baseplate and a removable collar assembly about 60 mm high, both of which can be firmly attached to the mould.
- 3.2 Steel rammer, having a 50 mm diameter face. For standard compactive effort, a rammer with a drop mass of 2700 g and a drop height of 300 mm. For modified compactive effort, a rammer with a drop mass of 4900 g and a drop height of 450 mm. Alternatively use a mechanical compactor, provided it meets the essential requirements of drop height, mass and energy input. A mechanical compactor may be used provided the essential dimensions are adhered to and the rammer has a free vertical fall of the correct height with blows being uniformly distributed and in keeping with any prescribed cycle of blows. The design of the compactor allows attachment of the mould to a level and rigid support base. The difference between MDD determinations using manual or mechanical compaction is less than 2%.
- 3.3 Balance of suitable capacity, with a resolution of at least 1 g and with a limit of performance within the range of  $\pm 5$  g.
- 3.4 Sieve, 19.0 mm and 9.50 mm conforming to ISO 3310.
- 3.5 Material height gauge. A flat steel bar, about 250 mm long, 25 mm wide and 1–3 mm thick is satisfactory (Note 8.1).

## 4 Sample preparation

The sample shall be prepared as follows:

- 4.1 Prepare the bulk sample in accordance with Section 4 of Test Method Q101 to produce a representative subsample of appropriate size. It may be necessary to dry the bulk sample before preparation so that the material is sufficiently dry to allow uniform mixing of the stabilising agent with the host material.
- 4.2 Further prepare the material by screening the subsample on the 19.0 mm sieve in accordance with Test Method Q101, Steps 5.2.1 to 5.2.3, ensuring that any aggregations are broken up to pass a 9.50 mm sieve. Discard any material retained on the 19.0 mm sieve and thoroughly remix the material passing the 19.0 mm sieve.
- 4.3 Prepare representative test portions of the sieved material in accordance with Test Method Q101, Steps 5.2.3 to 5.2.5 as follows:
  - a) at least three UCS compaction test portions. Each UCS compaction test portion must be of sufficient quantity to mould three specimens and provide a subsample for determining the achieved moisture content (Notes 8.2 and 8.3).
  - b) test portion for hygroscopic moisture content, and
  - c) four or more test portions to determine the OMC and MDD as indicated in Table 2.
- 4.4 Determine the mass of each UCS test portion ( $m_1$ ) prepared in Step 4.3 a).
- 4.5 Determine the hygroscopic moisture content ( $w_1$ ) of the test portion prepared in Step 4.3 b) in accordance with Test Method AS 1289.2.1.1.
- 4.6 Determine the OMC and MDD using the test portions prepared in Step 4.3 c) in accordance with Test Methods Q142A or Q142B as appropriate, using a Type A mould and each stabilising agent content.

## 5 Moulding

The sample shall be moulded as follows:

- 5.1 Where multiple MDR tests are performed using stabilising agent contents greater than zero percent, analyse these results as follows:
  - a) Plot separately MDD and OMC against stabilising agent content. Draw a line or curve of best fit through each plot.
  - b) Repeat any MDR test where its result is erratic within the set.
  - c) Interpolate values of dry density and moisture content from the respective plots to obtain the MDD and OMC for each stabilising agent content used in the testing program.
- 5.2 Calculate the target moisture content ( $w_t$ ) and target dry density ( $\rho_t$ ) to achieve the nominated relative compaction and nominated relative moisture content in accordance with Test Method Q145A.
- 5.3 Calculate the dry mass of material, quantity of stabilising agent, quantity of admixture, mass of mixing water and mass of dilution water, then mix and condition each UCS compaction test portion in accordance with Test Method Q135A (Notes 8.4 and 8.5).

- 5.4 Undertake all necessary calculations, mould preparation and compaction of the test portion in accordance with Test Method Q145A to achieve the nominated relative compaction and nominated relative moisture content for three specimens. Compacting each specimen in three equal layers for standard compaction or five equal layers for modified compaction (Note 8.6). Complete the compaction of all specimens within 65 minutes, timed from the first addition of mixing water to the mixture of host material and stabilising agent.

## 6 Calculations

Calculations shall be as follows:

- 6.1 Using the achieved moisture content, calculate the achieved dry density, achieved relative compaction and achieved relative moisture content for the specimen in accordance with Test Method Q145A.
- 6.2 Compare the achieved dry density and target dry density. If they differ by more than 0.02 t/m<sup>3</sup>, discard the specimen, and repeat the preparation to Q145A for the nominated conditions.
- 6.3 Compare the achieved moisture content and the target moisture content. If they differ by more than 1.0%, discard the specimen, and repeat the preparation to Q145A for the nominated conditions.

## 7 Reporting

The following shall be reported:

- 7.1 Moisture/density relationship results:
- a) MDD to the nearest 0.01 t/m<sup>3</sup>
  - b) OMC to the nearest 0.5%
- 7.2 The following in accordance with Test Method Q145A:
- a) Nominated relative compaction, nominated relative moisture content
  - b) Target dry density, target moisture content, and
  - c) Achieved dry density, achieved relative compaction, achieved moisture content and achieved relative moisture content.
- 7.3 The number of this Test Method, that is Q251A.

## 8 Notes on method

- 8.1 A material height gauge which allows monitoring of the height of compacted material relative to the top of a Mould A can be made from a steel bar and marked as follows:
- 8.1.1 Mould A (standard compaction): Commencing at one end of the bar, measure and mark distances of:
- a) 5.5 mm for the upper range of the third layer
  - b) 33.5 mm and 38.5 mm for the acceptable range of the second layer, and
  - c) 72.5 mm and 77.5 mm for the acceptable range of the first layer.

- 8.1.2 Mould A (modified compaction: Commencing at one end of the bar, measure and mark distances of:
- 5.5 mm for the upper range of the fifth layer
  - 17.5 mm and 22.5 mm for the acceptable range of the fourth layer
  - 40.5 mm and 45.5 mm for the acceptable range of the third layer
  - 63.5 mm and 88.5 mm for the acceptable range of the second layer, and
  - 87.5 mm and 92.5 mm for the acceptable range of the first layer.
- 8.1.3 Mark the face with the appropriate mould size (A).
- 8.2 For cement and cementitious blends sufficient test portions should be available to straddle the UCS range in increments of 0.5 to 1.0% stabilising agent content. This will sometimes require more than three compaction test portions.
- 8.3 For lime stabilisation sufficient test portions should be available to straddle a range of lime contents in increments of 2.0% stabilising agent content. This will usually require five compaction test portions.
- 8.4 When mixing and conditioning more than one test portion, sequence the work to conform with any time for conditioning and the time to completion of compaction. Measure both of these times from the addition of the first increment of water to the mixture of soil and stabilising agent.
- 8.5 Test portions which do not contain stabilising agents are to be compacted at the completion of mixing the material and water.
- 8.6 It may be advantageous to perform simultaneous compaction of the specimens where compaction is performed by compacting the same layer in each mould one after the other.

**Table 1 – Dimensions and tolerances of compaction apparatus**

Apparatus	Dimension	Tolerance
<b>Mould A</b>		
Internal diameter (mm)	105.0	± 0.5*
Height (mm)	115.5	± 0.5*
Nominal volume (cm <sup>3</sup> )	1000	± 15
<b>Rammer</b>		
Diameter; round foot (mm)	50	± 0.4
Area of rammer (mm <sup>2</sup> )	1964	± 31
<b>Standard Compaction (Mould A)</b>		
Drop (mm)	300	± 2.0 ‡
Mass (kg)	2.7	± 0.01 ‡
Energy delivered per blow (J)	7.94	± 0.08
Number of layers	3	
Number of blows/layer	25	
Energy input (kJ/m <sup>3</sup> )	596	± 14



Apparatus	Dimension	Tolerance
<b>Modified Compaction (Mould A)</b>		
Drop (mm)	450	± 2.0 ‡
Mass (kg)	4.9	± 0.01 ‡
Energy delivered per blow (J)	21.62	± 0.08
Number of layers	5	
Number of blows/layer	25	
Energy input (kJ/m <sup>3</sup> )	2703	± 60

\* Either but not both of the tolerances may be exceeded provided that the specified tolerance on volume is not exceeded.

‡ Either but not both of the tolerances may be exceeded provided that the appropriate tolerance on energy delivered per blow is not exceeded.

**Table 2 – Requirements for MDR tests**

Range in stabilising agent	MDR test requirements
Range ≤ 4%	1 test at 0% stabilising agent, if applicable 1 test at the central stabilising agent content
Range > 4%	1 test at 0% stabilising agent, if applicable 1 test at the lowest stabilising agent content 1 test at the central stabilising agent content 1 test at the highest stabilising agent content

## Test Method Q251B: Preparation and compaction of field mixed stabilised materials

### 1 Source

This Test Method was developed in-house using techniques evolved through internal departmental research investigations.

### 2 Scope

This Test Method describes the procedure to prepare and compact UCS specimens of soils and crushed rock which have been either modified or stabilised with a stabilising agent or are in their natural state. Use this method to compact field mixed materials to check field processes.

In the field, prepare test specimens by compacting passing 19.0 mm material. The test is performed under the following conditions, unless otherwise specified:

- Standard compaction.

### 3 Apparatus

Where appropriate, the working tolerances of apparatus are contained in Tables 1 and 2.

Examples of mould and rammers are contained in AS 1289.5.1.1, Figures 1 and 2 and AS 1289.5.2.1 Figure 2.

The following apparatus is required:

- 3.1 Mould assembly (Mould A), comprising a cylindrical metal mould having an internal diameter of 105 mm and an effective height of 115.5 mm, fitted with a detachable baseplate and a removable collar assembly about 60 mm high, both of which can be firmly attached to the mould.
- 3.2 Steel rammer, having a 50 mm diameter face. For standard compactive effort, a rammer with a drop mass of 2700 g and a drop height of 300 mm. For modified compactive effort, a rammer with a drop mass of 4900 g and a drop height of 450 mm. Alternatively use a mechanical compactor, provided it meets the essential requirements of drop height, mass and energy input. A mechanical compactor may be used provided the essential dimensions are adhered to and the rammer has a free vertical fall of the correct height with blows being uniformly distributed and in keeping with any prescribed cycle of blows. The design of the compactor allows attachment of the mould to a level and rigid support base. The difference between MDD determinations using manual or mechanical compaction is less than 2%.
- 3.3 Level rigid foundation on which to compact the specimen, for example a sound concrete floor about 100 mm or more in thickness or a concrete block of at least 100 kg mass.
- 3.4 Balance of suitable capacity, with a resolution of at least 1 g and with a limit of performance within the range of  $\pm 5$  g
- 3.5 Sieve, 19.0 mm and 9.50 mm conforming to ISO 3310.
- 3.6 Sealable containers, suitable for curing soil samples.
- 3.7 Tool for scarifying each compacted layer, such as a trowel or spatula.
- 3.8 Material height gauge. A flat steel bar, about 250 mm long, 25 mm wide and 1 – 3 mm thick is satisfactory (Note 9.1).

- 3.9 Levelling plate, a steel plate having a diameter of about 140 mm and a thickness of about 20 mm.
- 3.10 Steel straightedge, about 250 mm long, 25 mm wide and 3 mm thick, preferably with one bevelled edge.
- 3.11 Rubber mallet.
- 3.12 Mixing apparatus, such as a try, trowel or scoop and water sprayer.

## **4 Materials**

The following materials are required:

- 4.1 Mould oil, a light oil such as Caltex Mould Oil 20 (Note 9.3).

## **5 Sample preparation**

For field mixed materials sampled from either an insitu stabilising process or a plant-mixed process the procedure shall be as follows:

- 5.1 Obtain a sample of the field mixed material as soon as practicable after the completion of mixing using the sampling technique described in Test method Q061 Section 6. Seal the bulk sample in an airtight container for transport to the moulding location.
- 5.2 Prepare the material by screening the sample on a 19.0 mm sieve in accordance with Test Method Q101, Steps 5.2.1 to 5.2.3. Ensure moisture loss is minimised, and any aggregations are broken up to pass a 9.50 mm sieve. Discard the material retained in the 19.0 mm sieve and thoroughly remix the material passing the 19.0 mm sieve
- 5.3 Prepare a representative test portion of the sieved material in accordance with Test Method Q101, Steps 5.2.3 to 5.2.5 as follows:
  - a) UCS compaction test portion of sufficient quantity to compact three specimens, and
  - b) one test portion for achieved moisture content.
- 5.4 Place the test portion in an airtight container and put aside to precondition for 45 minutes, timed from commencement of field mixing.

## **6 Moulding**

### **6.1 Field mixed material – plant-mix**

For field mixed materials sampled from a plant-mixed process the procedure shall be as follows:

- 6.1.1 Undertake, the calculation of the mass of wet material per layer, mould preparation and compaction of the test portion in accordance with Test Method Q145A to achieve the nominated relative compaction and nominated relative moisture content for three specimens, then mould three specimens. Compacting each specimen in three equal layers for standard compaction or five equal layers for modified compaction (Note 9.3). Complete compaction of all specimens within 65 minutes, timed from the first addition of the mixing water to the mixture of host material and stabilising agent (Notes 9.4 and 9.5).

## 6.2 Field mixed material – in situ-mix

For field mixed materials sampled from an insitu stabilising process the procedure shall be as follows:

- 6.2.1 Clean and assemble each mould and baseplate, lightly oiling the internal surfaces. Inspect and clean the rammer or mechanical compactor and ensure that it is free in the guide.
- 6.2.2 Determine the mass ( $m_1$ ) of each mould and baseplate, attach the collars and place the assemblies on the rigid foundation.
- 6.2.3 At the end of the required conditioning period, spread the test portion on the mixing tray and thoroughly remix.
- 6.2.4 Obtain a subsample of the mixture and determine the achieved moisture content in accordance with Test Method AS 1289.2.1.1 ( $w_a$ ).
- 6.2.5 Mould the three specimens simultaneously in three equal layers using 25 rammer blows per layer for standard compaction or five equal layers using 25 rammer blows per layer for modified compaction, distributing the blows evenly over the surface of each layer (Note 9.3). Scarify each compacted layer to promote bonding and interlock between layers. Compaction must be completed within 65 minutes, timed from when the mixing water was added to the mixture of the host material and stabilising agent.
- 6.2.6 Free the material from around the collar of the mould assembly, then carefully remove the collar.
- 6.2.7 Level the compacted specimens to the top of their respective mould using a straightedge. Employ the straightedge to patch any hollows developed in the surface using smaller sized material.
- 6.2.8 Determine the mass ( $m_2$ ) of each mould, baseplate and compacted material.

## 7 Calculations

Calculations shall be as follows:

- 7.1 Using the achieved moisture content, calculate the achieved dry density in accordance with Test Method Q145A.

## 8 Reporting

The following shall be reported:

- 8.1 General information:
  - a) Source and description of the host material.
  - b) Source, type, ATIC Registration number and quantity of the stabilising agent(s) (Note 9.6).
- 8.2 The following in accordance with Test Method Q145A:
  - a) Achieved dry density and achieved moisture content
  - b) Compaction standard used, that is standard or modified.
- 8.3 The number of this Test Method, that is Q251B.

## 9 Notes on method

- 9.1 A material height gauge which allows monitoring of the height of compacted material relative to the top of a Mould A can be made from a steel bar and marked as follows:
- 9.1.1 Mould A (standard compaction): Commencing at one end of the bar, measure and mark distances of:
- 5.5 mm for the upper range of the third layer
  - 33.5 mm and 38.5 mm for the acceptable range of the second layer, and
  - 72.5 mm and 77.5 mm for the acceptable range of the first layer.
- 9.1.2 Mould A (modified compaction): Commencing at one end of the bar, measure and mark distances of:
- 5.5 mm for the upper range of the fifth layer
  - 17.5 mm and 22.5 mm for the acceptable range of the fourth layer
  - 40.5 mm and 45.5 mm for the acceptable range of the third layer
  - 63.5 mm and 88.5 mm for the acceptable range of the second layer, and
  - 87.5 mm and 92.5 mm for the acceptable range of the first layer.
- 9.1.3 Mark the face with the appropriate mould size (A).
- 9.2 Before handling capping compounds or oil, the operator should consult the relevant SDS.
- 9.3 It may be advantageous to perform simultaneous compaction of the specimens where compaction is performed by compacting the same layer in each mould one after the other.
- 9.4 It can be assumed that plant-mixed materials are sampled with a moisture content at target moisture content and will be compacted to 100% of MDD. Therefore, the required mass of mixed and cured/conditioned wet material per layer can be calculated as follows:

$$M_1 = \frac{V\rho_t(100 + w_t)}{100N}$$

- where
- |          |   |  |
|----------|---|--|
| $M_1$    | = | mass of wet material per layer (g)     |
| $V$      | = | mould volume (cm <sup>3</sup> )        |
| $\rho_t$ | = | target dry density (t/m <sup>3</sup> ) |
| $w_t$    | = | target moisture content (%)            |
| $N$      | = | number of layers.                      |

This calculation is based on Test Method Q145A Step 5.1.

- 9.5 The MDD and target moisture content values to be used when calculating the target dry density and target moisture content may be obtained from one of the following sources:
- assigned MDD obtained using Test Method Q144A
  - MDD obtained using Test Method Q142A or Q142B from a previous lot on the project
- 9.6 This can be requested from the supplier of the cementitious materials. Further details are available from the Australian Technical Infrastructure Committee (ATIC), *Cementitious Materials Registration Scheme (CMRS), Registered Products List*.

**Table 1 – Dimensions and tolerances of compaction apparatus**

Apparatus	Dimension	Tolerance
<b>Mould A</b>		
Internal diameter (mm)	105.0	± 0.5*
Height (mm)	115.5	± 0.5*
Nominal volume (cm <sup>3</sup> )	1000	± 15
<b>Rammer</b>		
Diameter; round foot (mm)	50	± 0.4
Area of rammer (mm <sup>2</sup> )	1964	± 31
<b>Standard Compaction (Mould A)</b>		
Drop (mm)	300	± 2.0 ‡
Mass (kg)	2.7	± 0.01 ‡
Energy delivered per blow (J)	7.94	± 0.08
Number of layers	3	
Number of blows/layer	25	
Energy input (kJ/m <sup>3</sup> )	596	± 14
<b>Modified Compaction (Mould A)</b>		
Drop (mm)	450	± 2.0 ‡
Mass (kg)	4.9	± 0.01 ‡
Energy delivered per blow (J)	21.62	± 0.08
Number of layers	5	
Number of blows/layer	25	
Energy input (kJ/m <sup>3</sup> )	2703	± 60

\* Either but not both of the tolerances may be exceeded provided that the specified tolerance on volume is not exceeded.

‡ Either but not both of the tolerances may be exceeded provided that the appropriate tolerance on energy delivered per blow is not exceeded.

## Test Method Q251C: Preparation and compaction of soil

### 1 Source

This Test Method was developed in-house using techniques evolved through internal departmental research investigations.

### 2 Scope

This Test Method describes the procedure to prepare and compact UCS specimens of soils including recycled blend materials in the laboratory. Prepare test specimens by compacting passing 19.0 mm material by standard or modified compactive effort to a nominated dry density and nominated moisture content, in accordance with Test Method Q145A.

The test is performed under the following conditions, unless otherwise specified:

- standard compaction
- nominated relative moisture content 100% of OMC, and
- nominated relative compaction 100% of MDD.

### 3 Apparatus

Where appropriate, the working tolerances of apparatus are contained in Tables 1 and 2. Examples of mould and rammers are contained in AS 1289.5.1.1, Figures 1 and 2 and AS 1289.5.2.1 Figure 2.

The following apparatus is required:

- 3.1 Mould assembly (Mould A), comprising a cylindrical metal mould having an internal diameter of 105 mm and an effective height of 115.5 mm, fitted with a detachable baseplate and a removable collar assembly about 60 mm high, both of which can be firmly attached to the mould.
- 3.2 Steel rammer, having a 50 mm diameter face. For standard compactive effort, a rammer with a drop mass of 2700 g and a drop height of 300 mm. For modified compactive effort, a rammer with a drop mass of 4900 g and a drop height of 450 mm. Alternatively use a mechanical compactor, provided it meets the essential requirements of drop height, mass and energy input. A mechanical compactor may be used provided the essential dimensions are adhered to and the rammer has a free vertical fall of the correct height with blows being uniformly distributed and in keeping with any prescribed cycle of blows. The design of the compactor allows attachment of the mould to a level and rigid support base. The difference between MDD determinations using manual or mechanical compaction is less than 2%.
- 3.3 Balance of suitable capacity, with a resolution of at least 1 g and with a limit of performance within the range of  $\pm 5$  g.
- 3.4 Sieve, 19.0 mm and 9.50 mm conforming to ISO 3310.
- 3.5 Material height gauge. A flat steel bar, about 250 mm long, 25 mm wide and 1–3 mm thick is satisfactory (Note 8.1).
- 3.6 Mixing apparatus, such as a tray, trowel or scoop.

## 4 Sample preparation

The sample shall be prepared as follows:

- 4.1 Prepare the bulk sample in accordance with Section 4 of Test Method Q101 to produce a representative subsample of appropriate size.
- 4.2 Further prepare the material by screening the subsample on the 19.0 mm sieve in accordance with Test Method Q101, Steps 5.2.1 to 5.2.2, ensuring that any aggregations are broken up to pass a 9.50 mm sieve. Discard any material retained on the 19.0 mm sieve and thoroughly remix the material passing the 19.0 mm sieve.
- 4.3 Prepare representative test portions of the sieved material accordance with Test Method Q101, Steps 5.2.3 to 5.2.5 as follows:
  - a) at least one UCS compaction test portion. Each UCS compaction test portion must be of sufficient quantity to mould three specimens and provide a sub sample for determining the achieved moisture content
  - b) test portion for hygroscopic moisture content, and
  - c) four or more test portions to determine the OMC and MDD.
- 4.4 Determine the mass of each UCS test portion ( $m_1$ ) prepared in Step 4.3 a).
- 4.5 Determine the hygroscopic moisture content ( $w_1$ ) of the test portion prepared in Step 4.3 as detailed in Test Method AS 1289.2.1.1.
- 4.6 Determine the OMC and MDD using the test portions prepared in Step 4.3 c) in accordance with Test Methods Q142A or Q142B as appropriate, using a Type A mould and using the specified curing time for the material in Test Method Q255 Table 1.

## 5 Moulding

The sample shall be moulded as follows:

- 5.1 Calculate the target moisture content ( $w_t$ ) and target dry density ( $\rho_t$ ) to achieve the nominated relative compaction and nominated relative moisture content in accordance with Test Method Q145A.
- 5.2 Calculate the dry mass of each test portion ( $m_2$ ) and mass of mixing water to be added ( $m_3$ ), then mix and cure each the test portion in accordance with Test Method Q255.
- 5.3 Undertake all necessary calculations, mould preparation and compaction of the test portion in accordance with Test Method Q145A to achieve the nominated relative compaction and nominated relative moisture content for three specimens. Compacting each specimen in three equal layers for standard compaction or five equal layers for modified compaction (Note 8.2).

## 6 Calculations

Calculations shall be as follows:

- 6.1 Using the achieved moisture content, calculate the achieved dry density, achieved relative compaction and achieved relative moisture content for each specimen in accordance with Test Method Q145A.
- 6.2 Compare the achieved dry density and target dry density. If they differ by more than 0.02 t/m<sup>3</sup>, discard the specimen, and repeat the preparation to Q145A for the nominated conditions.



- 6.3 Compare the achieved moisture content and the target moisture content. If they differ by more than 1.0%, discard the specimen, and repeat the preparation to Q145A for the nominated conditions.

## 7 Reporting

The following shall be reported:

- 7.1 General information:
- a) Source and description of the material
  - b) Nature and type of recycled materials, when recycled materials are tested (that is, recycled concrete, crushed glass and so on), and
- 7.2 Moisture/density relationship results:
- a) MDD to the nearest 0.01 t/m<sup>3</sup>
  - b) OMC to the nearest 0.5%
- 7.3 The following in accordance with Test Method Q145A :
- a) Nominated relative compaction, nominated relative moisture content
  - b) Target dry density, target moisture content
  - c) Achieved dry density, achieved relative compaction, achieved moisture content, achieved relative moisture content
  - d) Compaction standard used, that is standard or modified.
- 7.3 The number of this Test Method, that is Q251C.

## 8 Notes on method

- 8.1 A material height gauge which allows monitoring of the height of compacted material relative to the top of a Mould A can be made from a steel bar and marked as follows:
- 8.1.1 Mould A (standard compaction): Commencing at one end of the bar, measure and mark distances of:
- a) 5.5 mm for the upper range of the third layer
  - b) 33.5 mm and 38.5 mm for the acceptable range of the second layer, and
  - c) 72.5 mm and 77.5 mm for the acceptable range of the first layer.
- 8.1.2 Mould A (modified compaction): Commencing at one end of the bar, measure and mark distances of:
- a) 5.5 mm for the upper range of the fifth layer
  - b) 17.5 mm and 22.5 mm for the acceptable range of the fourth layer
  - c) 40.5 mm and 45.5 mm for the acceptable range of the third layer
  - d) 63.5 mm and 88.5 mm for the acceptable range of the second layer, and
  - e) 87.5 mm and 92.5 mm for the acceptable range of the first layer.
- 8.1.3 Mark the face with the appropriate mould size (A).
- 8.2 It may be advantageous to perform simultaneous compaction of the specimens where compaction is performed by compacting the same layer in each mould one after the other.

**Table 1 – Dimensions and tolerances of compaction apparatus**

<b>Apparatus</b>	<b>Dimension</b>	<b>Tolerance</b>
<b>Mould A</b>		
Internal diameter (mm)	105.0	± 0.5*
Height (mm)	115.5	± 0.5*
Nominal volume (cm <sup>3</sup> )	1000	± 15
<b>Rammer</b>		
Diameter; round foot (mm)	50	± 0.4
Area of rammer (mm <sup>2</sup> )	1964	± 31
<b>Standard Compaction (Mould A)</b>		
Drop (mm)	300	± 2.0 ‡
Mass (kg)	2.7	± 0.01 ‡
Energy delivered per blow (J)	7.94	± 0.08
Number of layers	3	
Number of blows / layer	25	
Energy input (kJ/m <sup>3</sup> )	596	± 14
<b>Modified Compaction (Mould A)</b>		
Drop (mm)	450	± 2.0 ‡
Mass (kg)	4.9	± 0.01 ‡
Energy delivered per blow (J)	21.62	± 0.08
Number of layers	5	
Number of blows / layer	25	
Energy input (kJ/m <sup>3</sup> )	2703	± 60

\* Either but not both of the tolerances may be exceeded provided that the specified tolerance on volume is not exceeded.

‡ Either but not both of the tolerances may be exceeded provided that the appropriate tolerance on energy delivered per blow is not exceeded.

## Test Method Q252: Plastic properties of a soil

### 1 Source

This Test Method was developed in-house using information contained within technical references.

### 2 Scope

This Test Method describes the procedure for determining the plastic properties of soils.

### 3 Definitions

For this Test Method the following definitions shall apply:

- 3.1 Weighted linear shrinkage (WLS) - is defined as the product of the linear shrinkage (LS) of a soil and the percentage of the soil finer than 0.425 mm.
- 3.2 Weighted plasticity index (WPI) - is defined as the product of the plasticity index (PI) of a soil and the percentage of the soil finer than 0.425 mm.

### 4 Procedure

The procedure shall be as follows

- 4.1 Determine weighted plasticity index as follows:
  - 4.1.1 Determine the plasticity index of a soil ( $I_p$ ) in accordance with Test Method AS 1289.3.3.1 or the cone plasticity index ( $I_{CP}$ ) of a soil in accordance with Test Method AS 1289.3.3.2.
  - 4.1.2 Determine the percent passing the 0.425 mm sieve ( $P_{0.425}$ ) in accordance with Test Method AS 1289.3.6.1 or AS 1289.3.6.3.
- 4.2 Determine weighted linear shrinkage as follows:
  - 4.2.1 Determine the linear shrinkage of a soil (LS) in accordance with Test Method AS 1289.3.4.1.
  - 4.2.2 Determine the percent passing the 0.425 mm sieve ( $P_{0.425}$ ) in accordance with Test Method AS 1289.3.6.1 or AS 1289.3.6.3

### 5 Calculations

Calculations shall be as follows:

- 5.1 Calculate the weighted plasticity index as follow:

$$WPI = I_p \cdot P_{0.425}$$

where

- WPI = weighted plasticity index of the soil (%)
- $I_p$  = plasticity index of the soil (%)
- $P_{0.425}$  = percentage passing the 0.425 mm sieve

or

$$WPI = I_{CP} \cdot P_{0.425}$$

where

- WPI = weighted plasticity index of the soil (%)
- $I_{CP}$  = cone plasticity index of the soil (%)
- $P_{0.425}$  = percentage passing the 0.425 mm sieve

- 5.2 Calculate the weighted linear shrinkage as follows:

$$WLS = LS \cdot P_{0.425}$$

where    WLS    =    weighted linear shrinkage of the soil (%)  
              LS     =    linear shrinkage of the soil (%)  
               $P_{0.425}$  =    percentage passing the 0.425 mm sieve

## 6     Reporting

The following shall be reported:

- 6.1    For weighted plasticity index:
  - a)    Plasticity index or cone plasticity index.
  - b)    Percent passing the 0.425 mm sieve.
  - c)    Weighted plasticity index to the nearest 1%.
- 6.2    For weighted linear shrinkage:
  - a)    Linear shrinkage.
  - b)    Percent passing the 0.425 mm sieve.
  - c)    Weighted linear shrinkage to the nearest 1%.
- 6.3    The number of this Test Method, that is Q252.

## Test Method Q253: Particle size and shape properties of a soil

### 1 Source

This Test Method was developed in-house using information contained within technical references.

### 2 Scope

This Test Method describes the procedure for determining the particle size and shape properties of soils.

### 3 Apparatus

The following apparatus is required:

- 3.1 Sieves conforming to ISO 3310 series, commonly used sieves include 75.0 mm, 37.5 mm, 19.0 mm, 9.50 mm, 4.75 mm, 2.36 mm, 1.18 mm, 0.600 mm, 0.300 mm, 0.150 mm and 0.075 mm. Additional sieves may be included to furnish the information required on the material to be tested or for specification compliance (Note 7.1).

### 4 Procedure

The procedure shall be as follows:

- 4.1 Determine the particle size distribution of a soil in accordance with Test Methods AS 1289.3.6.1 and if required, AS 1289.3.6.3.

### 5 Calculations

Calculations shall be as follows:

- 5.1 If fines ratio, fines to sand ratio or % < 0.075 mm / % < 0.300 mm ratio are required, calculate as follows.

- 5.1.1 Calculate the fines ratio as follows

$$FR = \frac{P_{0.075}}{P_{0.425}}$$

where FS = fines ratio

$P_{0.075}$  = percent passing the 0.075 mm sieve

$P_{0.425}$  = percent passing the 0.425 mm sieve

- 5.1.2 Calculate the fines to sand ratio as follows:

$$FSR = \frac{P_{0.075}}{P_{2.36}}$$

where FSR = fines to sand ratio (Note 7.2 and 7.3)

$P_{0.075}$  = percent passing the 0.075 mm sieve

$P_{2.36}$  = percent passing the 2.36 mm sieve

5.1.3 Calculate the % < 0.075 mm / % < 0.300 mm ratio as follows:

$$0.075/0.300 = \frac{P_{0.075}}{P_{0.300}}$$

where  $0.075/0.300$  = % < 0.075 mm / % < 0.300 mm ratio (Note 7.3)

$P_{0.075}$  = percent passing the 0.075 mm sieve

$P_{0.300}$  = percent passing the 0.300 mm sieve

5.2 If the coefficient of uniformity or the coefficient of curvature are required, calculate the following particle size values:

a) Calculate the particle size where 60% of particles are smaller as follows:

$$D_{60} = 10^{\left(\log D_2 + \frac{(60 - P_2)(\log D_1 - \log D_2)}{P_1 - P_2}\right)}$$

where  $D_{60}$  = particle size where 60% of particles are smaller (mm)

log = logarithm to base 10

$D_2$  = largest sieve with less than 60% passing (mm)

$P_2$  = percent passing  $D_2$

$D_1$  = smallest sieve with more than 60% passing (mm)

$P_1$  = percent passing  $D_1$

b) Calculate the particle size where 10% of particles are smaller as follows:

$$D_{10} = 10^{\left(\log D_2 + \frac{(10 - P_2)(\log D_1 - \log D_2)}{P_1 - P_2}\right)}$$

where  $D_{10}$  = particle size where 10% of particles are smaller (mm)

log = logarithm to base 10

$D_2$  = largest sieve with less than 10% passing (mm)

$P_2$  = percent passing  $D_2$

$D_1$  = smallest sieve with more than 10% passing (mm)

$P_1$  = percent passing  $D_1$

c) Calculate the particle size where 30% of particles are smaller as follows:

$$D_{30} = 10^{\left(\log D_2 + \frac{(30 - P_2)(\log D_1 - \log D_2)}{P_1 - P_2}\right)}$$

- where
- $D_{30}$  = particle size where 30% of particles are smaller (mm)
  - log = logarithm to base 10
  - $D_2$  = largest sieve with less than 30% passing (mm)
  - $P_2$  = percent passing  $D_2$
  - $D_1$  = smallest sieve with more than 30% passing (mm)
  - $P_1$  = percent passing  $D_1$

5.3 Calculate the coefficient of uniformity as follows:

$$C_u = \frac{D_{60}}{D_{10}}$$

- where
- $C_u$  = coefficient of uniformity
  - $D_{60}$  = particle size where 60% of particles are smaller
  - $D_{10}$  = particle size where 10% of particles are smaller

5.4 Calculate the coefficient of curvature as follows:

$$C_c = \frac{D_{30}^2}{D_{10}D_{60}}$$

- where
- $C_c$  = coefficient of curvature
  - $D_{30}$  = particle size where 30% of particles are smaller
  - $D_{10}$  = particle size where 10% of particles are smaller
  - $D_{60}$  = particle size where 60% of particles are smaller

5.5 If required, calculate the grading coefficient as follows:

$$G_c = \frac{(P_{26.5} - P_{2.00})P_{4.75}}{100}$$

- where
- $G_c$  = grading coefficient (Note 7.2)
  - $P_{26.5}$  = percent passing the 26.5 mm sieve
  - $P_{2.00}$  = percent passing the 2.00 mm sieve
  - $P_{4.75}$  = percent passing the 4.75 mm sieve

## 6 Reporting

The following shall be reported:

6.1 Fines ratio to the nearest 0.01 units.

- 6.2 Fines to sand ratio to the nearest 0.01 units (if required).
- 6.3 The % < 0.075 mm / % < 0.300 mm ratio to the nearest 0.01 units (if required).
- 6.4 Coefficient of uniformity to the nearest 0.1 for results 1 or greater and to the nearest 0.01 for results less than 1.
- 6.5 Coefficient of curvature to the nearest 0.1 for results 1 or greater and to the nearest 0.01 for results less than 1.
- 6.6 Grading coefficient to the nearest 0.1 units.
- 6.7 The number of this Test Method, that is Q253.

## **7 Notes on method**

- 7.1 Where particle size results are used to calculate properties such as coefficient of uniformity and coefficient of curvature, the sieves listed in Clause 3.1 should be used to ensure there are sufficient data points to establish the particle size distribution curve and allow for the interpolation of particle sizes in Step 5.2 without introducing significant error.
- 7.2 The following properties are defined in the Australian Road Research Board (May 2020)
  - a) grading coefficient in Appendix A, Figure A 4, and
  - b) fines to sand ratio in Appendix A, Table A 5.
- 7.3 The following properties are defined in the Kapitzke FJ (2014):
  - a) fines to sand ratio (% < 0.075 mm / % < 2.36 mm) in Table 2, and
  - b) % < 0.075 mm / % < 0.300 mm in Table 2.

## **8 References**

- 8.1 Australian Road Research Board (May 2020) *Roads Materials Best Practice Guide 1*
- 8.2 Kapitzke FJ (2014) *Western Queensland Best Practice Guidelines – WQ35 Paving Materials and Type Cross Sections for Roads on Expansive Soils in Western Queensland*, Department of Transport and Main Roads.



## Test Method Q254A: Addition of foamed bitumen

### 1 Source

This Test Method was developed in-house using techniques evolved through internal departmental research investigations.

### 2 Scope

This Test Method describes the procedure for mixing of foamed bitumen stabilised materials.

### 3 Apparatus

Where appropriate the working tolerances of apparatus are contained in Table 1.

The following apparatus is required:

#### 3.1 Foaming equipment:

- a) Bitumen foaming plant, capable of manufacturing foamed bitumen with a minimum expansion ratio of 10 and a minimum half-life of 20 seconds, heating bitumen between 140 and 180°C, maintaining bitumen temperature to within 2°C of set temperature, adding water to bitumen at rates between 0 and 5% by bitumen mass and control bitumen flow and water settings. The plant is to be configurable to measure the characteristic of the foamed bitumen produced (expansion ratio and half-life) (Note 8.1).
- b) Metal container for checking the flow of foamed bitumen, having an internal diameter of 300 mm, a depth of 280 mm and a capacity of 15 litres.
- c) Oven of suitable capacity, capable of heating bitumen to 100°C.
- d) Mechanical mixing equipment, twin-shaft mixer with a capacity of about 30 kg, with variable settings for speed and mixing time. Should have a cover to allow direct discharge of foamed bitumen into mixer without splash or loss of material. (Note 8.1).
- e) Suitable tools for removing all materials from mixer such as a mallet, spatula and scoop.

#### 3.2 Foam characteristic equipment

- a) Metal container for checking the flow of foamed bitumen, having an internal diameter of 300 mm, a depth of 280 mm and a capacity of 15 litres.
- b) Dipstick marked at intervals indicating expansion ratios (assuming 500 g of bitumen) or a rule that is longer than the depth of the discharge container capable of measuring the foam depth to 5 mm.

3.3 Balance of suitable capacity, having a resolution of at least 0.1 g and with a limit of performance within the range of  $\pm 0.5$  g.

3.4 Sieves, 37.5 mm and 9.50 mm, conforming to ISO 3310.

3.5 Stopwatch with a resolution not exceeding 0.1 seconds.

3.6 Thermometer, a partial immersion thermometer or other suitable temperature measuring device having a temperature range of at least 150 C - 250°C and graduated to 1°C or less with an uncertainty of no more than 0.5°C.

3.7 Container(s) for storing manufactured material.

## 4 Materials

The following materials are required (Note 8.2):

- 4.1 Bitumen, Class 170 sampled from a bulk supply and free of cutter, flux or other additives (usually supplied in 10 litre tins).
- 4.2 Foaming additive (Teric 311, Interfoam or equivalent).
- 4.3 Hydrated lime (Note 8.3):
  - a) conforming to AS 1672.1: Limes and Limestones; Part 1 – Limes for building
  - b) not more than three months old, measured from date of manufacture, and
  - c) with an available lime index not less than 80%.
- 4.4 Hydrated lime / flyash blend including hydrated lime conforming to Clause 4.3.
- 4.5 Potable water.

## 5 Calculation of mix quantities

The mix quantities shall be calculated as follows:

- 5.1 For each foamed bitumen test portion:
  - 5.1.1 Calculate the target moisture content as follows:

$$w_t = w_o \frac{RM_n}{100}$$

- where
- $w_t$  = target moisture content (%)
  - $w_o$  = optimum moisture content (%)
  - $RM_n$  = nominated relative moisture content (%) (Note 8.4)

- 5.1.2 Calculate the mass of mixing water to be added as follows (Note 8.5):

$$m_3 = \frac{m_2 w_t}{100} - (m_1 - m_2) + 60p_1$$

- where
- $m_3$  = mass of mixing water to be added (g)
  - $m_2$  = mass of dry material in test portion (g)
  - $w_t$  = target moisture content (%)
  - $m_1$  = mass of wet material in test portion (g)
  - $p_1$  = stabilising agent content (lime or lime / flyash) (%)

- 5.1.3 Calculate the mass of bitumen required as follows:

$$m_b = \frac{(1 + LF)m_2 p_2}{100}$$

- where
- $m_b$  = mass of bitumen (g)
  - $LF$  = loss factor (usually 0.013) (Note 8.6)
  - $m_2$  = mass of dry material in test portion (g)
  - $p_2$  = stabilising agent content (bitumen) (%)

- 5.1.4 Calculate the mass of foaming additive (if required) as follows (Note 8.7):

$$m_{fa} = 0.005(m_{b1} - m_{b2})$$

- where  $m_{fa}$  = mass of foaming additive (g)  
 $m_{b1}$  = mass of bitumen and container before heating (g)  
 $m_{b2}$  = mass of residual bitumen and container after transfer (g)

## 6 Production of foamed bitumen material

The foamed bitumen material shall be produced as follows:

### 6.1 Preparation of foaming apparatus

- 6.1.1 Before foaming it is necessary to conduct trials for each batch of bitumen to determine the optimum mass flow of bitumen and foamant water flow to achieve a minimum expansion ratio of 10 and half-life of 20 seconds (Note 8.8).
- 6.1.2 Determine the mass of the container and bitumen before heating ( $m_{b2}$ ).
- 6.1.3 Preheat the bitumen in an oven to 100°C (Note 8.9).
- 6.1.4 Preheat the foaming apparatus to about 140°C (this usually takes about 20 minutes).
- 6.1.5 Transfer the hot bitumen from the oven to the foaming apparatus. Turn on the bitumen pump and circulate while heating the bitumen to 180°C.
- 6.1.6 Determine the mass of the residual bitumen and container after transfer ( $m_{b2}$ ).
- 6.1.7 Add the foaming additive, if required, to the foaming apparatus and continue circulating the bitumen for approximately 10-15 minutes before commencing the production of foamed bitumen.
- 6.1.8 Using the metal container, check to ensure the foaming apparatus will discharge 500 g of bitumen and adjust the bitumen pump timer if necessary.

### 6.2 Foaming and mixing

- 6.2.1 Add the dry material to the mixer and distribute the dry additive (lime or lime / flyash) evenly over the surface of the dry materials.
- 6.2.2 Mix the dry material and dry additive for 2 minutes adding the mixing water gradually to the mixer.
- 6.2.3 Discharge the material from the mixer and transfer to suitable airtight storage containers and allow to condition for 45 minutes.
- 6.2.4 Return the material to the mixer and mix the material for a further 2 minutes.
- 6.2.5 Move the mixer adjacent to the foaming apparatus and add the mass of bitumen as foam to the mixer.
- 6.2.6 Move the mixer away from the foaming apparatus and continue mixing for a further 2 minutes.
- 6.2.7 Transfer the material from the mixer to a suitable storage container(s). A rubber mallet, spatula and scoop may be used to assist with loosening material adhering to the interior of the mixer.

## 7 Reporting

The following shall be reported:

- 7.1 Mix details including:
- a) The date and time of mixing.
  - b) Bitumen grade, source and target percentage added.
  - c) Foaming agent used and amount added.
  - d) Type of secondary binder used, source and percentage added.
- 7.2 The number of this Test Method, that is Q254A.

## 8 Notes on method

- 8.1 The Wirtgen WLB 10 S laboratory foamed bitumen plant and WLM 30 laboratory mixer have been found to be suitable.
- 8.2 Before handling bitumen, foaming additive, hydrated lime or lime / flyash, the operator should consult the relevant SDS.
- 8.3 If the available lime index is required to be supplied with the test report, for example Technical Specification MRTS09 *Plant-Mixed Foamed Bitumen Stabilised Pavements* Clause 6.3. Determine the available lime index in accordance with Test Method AS 4489.6.1: *Test methods for limes and limestones – Lime index – Available lime* and provide the test report or provide a test certificate from the lime supplier that includes the result for available lime index.
- 8.4 A nominated relative moisture content of 70% for standard compaction and 85% for modified compaction have been found to be appropriate. These values may need to be adjusted to ensure the optimum moisture to achieve full compaction and distribution of the foamed bitumen through the material.
- 8.5 The value of  $60p_1$  is included to provide extra water for hydrated lime reactions.
- 8.6 The loss factor allows for the binder retained within the mixer. This can be checked by taking subsamples of the mixture and testing for binder content in accordance with Test Method Q118. As the mixer wears it may be necessary to increase the loss factor.
- 8.7 Foaming additive volume of 0.5% by mass of bitumen has been found to be adequate for most materials.
- 8.8 Further information on optimising the mass flow of bitumen and foamant water flow may be found in the Wirtgen GmbH (2012), *Cold Recycling Manual, 2012* and Austroads Test Method AG:PT/T301 – *Determining the foaming characteristics of bitumen*.
- 8.9 Bitumen may be heated for at least 12 hours but not exceeding 72 hours at 100°C before transferring to the foaming machine.

**Table 1 – Dimensions and tolerances for compaction apparatus**

<b>Apparatus</b>	<b>Dimension</b>	<b>Tolerance</b>
<b>Mould</b>		
Internal diameter (mm)	152.40	± 0.2
<b>Hammer</b>		
Tamping face diameter (mm)	149.4	± 0.1
Sliding weight mass (kg)	10.21	± 0.01
Free fall (mm)	457.2	± 2.5

## Test Method Q254B: Curing moulded specimens of foamed bitumen stabilised material

### 1 Source

This Test Method was developed in-house using techniques evolved through internal departmental research investigations.

### 2 Scope

This Test Method describes the procedures for curing laboratory mixed and field mixed specimens containing foamed bitumen under standard conditions.

### 3 Apparatus

The following apparatus is required:

#### 3.1 Initial curing:

- a) Environmental cabinet, a temperature-controlled cabinet that is, capable of holding at least three test specimens, maintaining a temperature of  $25^{\circ}\text{C} \pm 0.5^{\circ}\text{C}$  and fitted with an external device that indicates the temperature inside the cabinet.

#### 3.2 Oven curing:

- a) Drying oven, of suitable capacity, having a temperature of  $40 \pm 2.0^{\circ}\text{C}$  and conforming to AS 1289.0.

#### 3.3 Vacuum soaking:

- a) Vacuum apparatus and chamber, and
- b) Container for soaking specimens.

### 4 Materials

The following materials are required:

#### 4.1 Potable water.

#### 4.2 Cloths for removing excess water from vacuum soaked specimens.

### 5 Procedure

The curing of specimens shall be as follows:

#### 5.1 Initial curing

5.1.1 Place the specimens in the environmental cabinet and allow to equilibrate to the test temperature in accordance with Table 1 for initial or as received modulus.

5.1.2 At the completion of the initial curing remove the specimens from the cabinet.

#### 5.2 Oven curing

5.2.1 Place the specimens in the drying oven and dry in accordance with Table 1 for cured modulus.

5.2.2 Transfer the specimen to the environmental cabinet and allow to equilibrate to the test temperature in accordance with Table 1 for cured modulus.

### **5.3 Vacuum soaking**

- 5.3.1 After completion of the cured modulus testing, place the specimens in a container and cover with potable water at  $25 \pm 0.5^{\circ}\text{C}$ .
- 5.3.2 Place the container, water and specimen in the vacuum chamber and apply a partial vacuum in accordance with Table 1 for soaked modulus (Note 7.1).
- 5.3.3 After the vacuum soaking remove the specimens from the water and using cloths remove excess water.

### **6 Reporting**

The following shall be reported:

- 6.1 The number of this Test Method, that is Q254B.

### **7 Notes on method**

- 7.1 A partial vacuum of 13 kPa absolute pressure is approximately equivalent to a -88 kPa reading on a vacuum gauge at sea level.

**Table 1 – Standard curing conditions**

<b>Specimen type</b>	<b>Test type*</b>	<b>Curing duration and conditions</b>
Laboratory mixed	Initial modulus	(i) 3 ± 0.5 hours curing in environmental chamber at 25 ± 0.5°C
	Three day cured modulus	(i) 69 ± 0.5 hours curing in drying oven at 40 ± 2.0°C (ii) 3 ± 0.5 hours curing in environmental chamber at 25 ± 0.5°C
	Three day, soaked modulus	(i) 10 minutes in vacuum chamber with a partial vacuum of 13 kPa or less absolute pressure applied
Field mixed – from insitu stabilisation	Three day cured modulus	(i) 69 ± 0.5 hours curing in drying oven at 40 ± 2.0°C (ii) 3 ± 0.5 hours curing in environmental chamber at 25 ± 0.5°C
	Three day, soaked modulus	(i) 10 minutes in vacuum chamber with a partial vacuum of 13 kPa or less absolute pressure applied
Field mixed – from plant mixed stabilisation	Three day cured modulus	(i) 69 ± 0.5 hours curing in drying oven at 40 ± 2.0°C (ii) 3 ± 0.5 hours curing in environmental chamber at 25 ± 0.5°C
	Three day, soaked modulus	(i) 10 minutes in vacuum chamber with a partial vacuum of 13 kPa or less absolute pressure applied
	Seven day cured modulus	(i) 165 ± 0.5 hours curing in drying oven at 40 ± 2.0°C (ii) 3 ± 0.5 hours curing in environmental chamber at 25 ± 0.5°C
	Seven day, soaked modulus	(i) 10 minutes in vacuum chamber with a partial vacuum of 13 kPa or less absolute pressure applied
	Fourteen day, cured modulus	(i) 333 ± 0.5 hours curing in drying oven at 40 ± 2.0°C (iii) 3 ± 0.5 hours curing in environmental chamber at 25 ± 0.5°C
	Fourteen day, soaked modulus	(i) 10 minutes in vacuum chamber with a partial vacuum of 13 kPa or less absolute pressure applied
	Core samples	As received modulus
	Soaked modulus	(i) 10 minutes in vacuum chamber with a partial vacuum of 13 kPa or less absolute pressure applied



## Test Method Q255: Addition of water

### 1 Source

This Test Method was developed in-house using techniques evolved through internal departmental research investigations.

### 2 Scope

This Test Method describes the procedure for calculating the quantity of water to add to a host soil or crushed rock as well as the procedures for mixing, by either hand or machine, and the curing of the mixture prior to compaction.

### 3 Apparatus

The following apparatus is required:

#### 3.1 Mixing apparatus:

- a) For hand mixing, miscellaneous mixing apparatus, such as a tray, trowel or scoop and water spray suitable for mixing water increments into the material.
- b) For machine mixing, mechanical mixing equipment, for example, pugmill or catering style dough mixer capable of mixing test portions.
- c) Suitable tools for removing all materials from mixer such as a mallet, spatula and scoop.

#### 3.2 Sealable containers, suitable for curing mixed test portions.

#### 3.3 Balance, of suitable capacity, with a resolution of at least 0.1 g and with a limit of performance within the range of 0.5 g, and

### 4 Materials

The following materials are required:

#### 4.1 Potable water for mixing.

### 5 Calculation of addition rates

The addition rates shall be calculated as follows:

#### 5.1 Calculate the dry mass of each test portion as follows:

$$m_2 = \frac{100m_1}{100 + w_1}$$

- where
- |       |   |  |
|-------|---|--|
| $m_2$ | = | mass of dry material in test portion (g) |
| $m_1$ | = | mass of wet material in test portion (g) |
| $w_1$ | = | hygroscopic moisture content (%)         |

5.2 Calculate the mass of mixing water to be added as follows (Note 9.1):

$$m_3 = \frac{m_2 w_t}{100} - (m_1 - m_2)$$

where	$m_3$	=	mass of mixing water to be added (g) (Note 9.1)
	$m_2$	=	mass of dry material in test portion (g)
	$w_t$	=	target moisture content (%)
	$m_1$	=	mass of wet material in test portion (g)

## 6 Procedure – hand mixing

Test portions are to be mixed in turn with the required amount of mixing water, then, cured prior to compaction as follows (Note 9.1):

- 6.1 Measure out the required mass of mixing water ( $m_3$ ).
- 6.2 Spread one of the test portions on the mixing tray.
- 6.3 Incorporate the mixing water with the material in small increments, combining thoroughly to form a uniform mixture.
- 6.4 Place the mixture in a sealable container and put it aside to cure for the time specified for the material (refer to Table 1), timed from when the mixing water was first added to the mixture (Note 9.2 and 9.3).
- 6.5 Record the time of commencement and completion of the curing.
- 6.6 Record the method for determining the plasticity level (refer to Table 1), that is, test method, source records or visual/tactile assessment.
- 6.7 Repeat Steps 6.1 to 6.4 for each test portion.

## 7 Procedure – machine mixing

Test portions are to be mixed in turn with the required amount of mixing water, then cured prior to compaction as follows:

- 7.1 Measure out the required mass of mixing water.
- 7.2 Add the test portion to the mixer. Mix the test portion for 15 seconds to spread the material evenly in the mixer.
- 7.3 Mix the material for 120 seconds and incorporate the mixing water with the material in small increments, combining thoroughly to form a uniform mixture.
- 7.4 Allow the material to stand in the mixer for 120 seconds, then mix the water with the material for a further 120 seconds.
- 7.5 Transfer the mixture to a sealable container and put it aside to cure for the time specified for the material (refer to Table 1), timed from when the mixing water was first added to the host material. A rubber mallet, spatula and scoop may be used to assist with loosening material adhering to the interior of the mixer (Note 9.2 and 9.3).
- 7.6 Record the time of commencement and completion of the curing.
- 7.7 Record the method for determining the plasticity level (refer to Table 1), that is, test method, source records or visual/tactile assessment.
- 7.8 Repeat Steps 7.1 to 7.6 for each test portion.

## 8 Reporting

The following shall be reported:

- 8.1 Mix details:
- a) Source and description of the host material
  - b) Duration of curing to the nearest hour, and
  - c) Method for determining the plasticity level (refer to Table 1), that is, test method, source records or visual/tactile assessment.
- 8.2 The number of this Test Method, that is Q255.

## 9 Notes on method

- 9.1 It is necessary to make some allowance for loss of moisture during mixing. This allowance will depend on the type of material under test and the ambient conditions in the laboratory. Add this allowance to the calculated mass of water ( $m_3$ ).
- 9.2 It is important to mix water thoroughly into the material and the test portion cured for sufficient time to allow the even distribution of water throughout the material.
- 9.3 Where the liquid limit has not been determined in accordance with Test Methods Q104A or Q104D use either a liquid limit from source records or an estimate based on a visual/tactile assessment for estimating the curing time for the CBR test portions.

**Table 1 – Minimum curing time**

Plasticity	Condition of prepared test portion	
	Sample moisture content within $w_t \pm 2\%$	Sample moisture content outside $w_t \pm 2\%$
Sands and granular material*	2 h	2 h
Low (LL $\leq$ 35%)	24 h	48 h
Medium (35 < LL $\leq$ 50%)	48 h	96 h (4 days)
High (LL > 50%)	96 h (4 days)	168 h (7 days)

\* These can include naturally occurring sands and gravels, crushed rocks and manufactured materials with a fines (< 0.075 mm) content typically less than 12% and low plasticity.

$w_t$  = target moisture content.

## Test Method Q257: Modified compression test for pavement materials – Texas triaxial

### 1 Source

This Test Method is based on TfNSW Test Method *T171: Modified Texas triaxial compression test for pavement materials*. It differs from this method by minor procedural variations, minor changes to reporting requirements and terminology used in Transport and Main Roads test methods.

### 2 Scope

This Test Method describes the procedure to determine the shearing resistance of pavement materials, that is, base and sub-base. It was originally based on the Texas Highway Department's Test Method *Tex 117-E-Triaxial Compression Tests for Disturbed Soils and Base Materials*.

The test applies an axial load to cylindrical specimens supported by various known normal stresses until failure occurs. The test is performed under the following conditions, unless otherwise specified:

- standard compaction
- nominated relative moisture content 83 to 87% of OMC, and
- nominated relative compaction 99 to 101% of MDD.

### 3 Apparatus

Where appropriate, the working tolerances of apparatus are contained in Table 1.

Example of rammer is contained in AS 1289.5.1.1, Figure 2.

The following apparatus is required:

- 3.1 Loading equipment capable of applying a vertical load up to 50 kN, normal confining pressure of up to 100 kPa and able to deform the specimen at a rate of 4.1 mm / minute consisting of the following:
  - a) Device for vertical load measurement conforming to the requirements of AS 2193 for Class A testing machines.
  - b) Vertical displacement measuring device conforming to the requirements of ISO 463 or JIS B 7503 with a scale interval of 0.1 mm and a minimum travel of 20 mm, or a displacement transducer of at least equal performance.
  - c) Axial cell with dimensions approximately 170 mm internal diameter and 300 mm height, fitted with air connection and tubular rubber membrane approximately 153 mm diameter.
  - d) Normal confining pressure controllable within 5 kPa of the required applied pressure using a device that conforms to the accuracy requirements of AS 1349 for industrial gauges.
  - e) A plunger with a spherical end.
  - f) Computer and data acquisition equipment capable of recording the data from the load and displacement to the required accuracy. Where an electronic data acquisition system is used to directly capture, record and analyse test data, it requires a precision at least equivalent to the apparatus replaced.
- 3.2 End blocks, two hollow metal end plate blocks of approximately 153 mm diameter.
- 3.3 Bearing plate, with spherical seat.

- 3.4 Sieves, 37.5 mm and 9.50 mm, conforming to ISO 3310.
- 3.5 Air curing environment such as, sealed or moulded specimens, capable of maintaining a temperature of  $23 \pm 2^\circ\text{C}$ .
- 3.6 Calliper, capable of measuring the length and diameter of each specimen, with a resolution of at least 0.1 mm and conforming to the requirements of ISO 13385-1 or JIS B 7507.
- 3.7 Vacuum pump.
- 3.8 Compressed air supply with pressure regulating valve.
- 3.9 Mould assembly, comprising a cylindrical metal mould having an internal diameter of  $153 \pm 0.5$  mm and internal effective height of  $203 \pm 0.5$  mm. With a detachable baseplate and a removable collar having a height of about 50 mm, both of which can be firmly attached to, or removed from, the mould.
- 3.10 Rammer, a metal rammer having a 50 mm diameter face, a drop mass of 2700 g and a drop height of 300 mm. A mechanical compactor may be used provided the essential dimensions are adhered to and the rammer has a free vertical fall of the correct height with blows being uniformly distributed and in keeping with any prescribed cycle of blows. The design of the compactor allows attachment of the mould to a level and rigid support base. The difference between MDD determinations using manual or mechanical compaction is less than 2%.
- 3.11 Sample extruder, such as a jack, lever frame or other device suitable for extracting compacted soil specimens from the mould.
- 3.12 Balance of suitable capacity, with a resolution of at least 1 g and with a limit of performance within the range of  $\pm 5$  g.
- 3.13 Mixing apparatus, such as steel tray, trowel, spatulas and scoop.
- 3.14 Metal dishes.
- 3.15 Material height gauge. A flat steel bar, about 250 mm long, 25 mm wide and 1-3 mm thick is satisfactory (Note 11.1).

#### **4 Definitions**

For this Test Method the following definitions shall apply:

- 4.1 Axial load – the sum of the applied load and the dead load and is applied along the vertical axis of the specimen.
- 4.2 Axial strain – the axial deformation of the specimen divided by the original height.
- 4.3 Compressive modulus – the slope of the straight-line portion of the axial stress-strain curve.
- 4.4 Normal stress – the force supplied by air in the cell and applied in a radial direction to the cylindrical specimen.
- 4.5 Mohr's diagram – a graphical construction used in analysing data from tests on bodies acted on by combined forces in static equilibrium.
- 4.6 Mohr's circle of failure – a stress circle constructed from principal stresses acting on the specimen at failure.
- 4.7 Mohr's envelope of failure – the common tangent to a series of failure circles constructed from different pairs of principal stresses required to fail the material.

## 5 Materials

The following material is required:

- 5.1 Mould oil, a light oil such as Caltex Mould Oil 20 (Note 11.2).

## 6 Sample preparation

The sample shall be prepared as follows:

- 6.1 Prepare the bulk sample in accordance with Section 5 of Test Method Q101 to produce a representative subsample of appropriate size.
- 6.2 Further prepare the material by screening the subsample on the 37.5 mm sieve in accordance with Test Method Q101, Steps 5.2.1 to 5.2.3, ensuring that any aggregations are broken up to pass a 9.50 mm sieve. Discard any material retained on the 37.5 mm sieve and thoroughly remix the material passing the 37.5 mm sieve.
- 6.3 Prepare representative test portions of the sieved material in accordance with Test Method Q101, Steps 5.2.3 to 5.2.5 as follows:
  - a) At least three compaction test portions. Each compaction test portion must be of sufficient quantity to mould a test specimen and provide a subsample for determining the achieved moisture content
  - b) test portion for hygroscopic moisture content, and
  - c) four or more test portions to determine the OMC and MDD.
- 6.4 Determine the mass of each compaction test portion ( $m_1$ ) prepared in Step 6.3 a).
- 6.5 Determine the hygroscopic moisture content ( $w_1$ ) of the test portion prepared in Step 6.3 b) in accordance with Test Method AS 1289.2.1.1.
- 6.6 Determine If the OMC and MDD using the test portions prepared in Step 6.3 d) in accordance with Test Method Q142A using the specified curing time for the material in Test Method Q255 Table 1. If all material passes the 19.0 mm sieve in Step 6.2, use a Type A mould; otherwise, use the Type B mould.

## 7 Compaction of specimens

### 7.1 Curing

- 7.1.1 Calculate the target moisture content ( $w_t$ ) and target dry density to achieve the nominated relative compaction and nominated relative moisture content in accordance with Test Method Q145A
- 7.1.2 Calculate the dry mass of each test portion ( $m_2$ ) and mass of mixing water to be added ( $m_3$ ), then mix and cure each the test portion in accordance with Test Method Q255.

### 7.2 Compaction

- 7.2.1 Undertake all necessary calculations, mould preparation and compaction of the test portion in accordance with Test Method Q145A to achieve the nominated relative compaction and nominated relative moisture content. Compacting the specimen in five equal layers for standard compaction.
- 7.2.2 Where the specimen contains more than 10% RAP, place the moulded specimen in an air curing environment and maintain a temperature of  $23 \pm 2^\circ\text{C}$  for seven days to allow for the dissipation of pore pressures.

- 7.2.3 Where specimens are not tested immediately, take steps to ensure the moisture content remains constant. For example, cover the top of the specimens with plastic film and hold in place using the compaction collar. Where specimens are removed from the mould they may be wrapped in damp paper or cloth and sealed with plastic film.
- 7.2.4 Place the lower metal end plate block under the mould and eject the compacted specimen from the mould by sample extruder.
- 7.2.5 Measure the height ( $h_s$ ) and diameter ( $d_s$ ) of the specimen to the nearest 0.5 mm (Note 11.3).
- 7.2.6 Determine the combined mass of the upper metal end plate block and bearing plate ( $m_d$ ).
- 7.2.7 Place the upper metal end plate block on top of the specimen and enclose the specimen in the Texas triaxial cell.

## 8 Testing of specimens

The Texas triaxial testing shall be performed as follows:

- 8.1 Use normal stresses ( $\sigma_3'$ ) of 10 kPa
- 8.2 Place the Texas triaxial cell and specimen on the load frame platen and centre the specimen with upper and lower metal end blocks in place on the platen.
- 8.3 Place and centre the bearing plate on the upper end block.
- 8.4 Raise the platen, align and seat the plunger into the spherical seat of the bearing plate.
- 8.5 Apply just enough load to obtain a perceptible reading on the load gauge and initialise the reading.
- 8.6 Connect the air-line to the Texas triaxial cell and apply and hold the specified normal stress to the specimen.
- 8.7 Attach the displacement measuring device and initialise the reading.
- 8.8 Apply the load at a deformation rate of 4.1 mm per minute. Record the load gauge ( $P_i$ ) at each 0.5 mm increment of deformation ( $d_i$ ) of the specimen. Continue loading until either the specimen fails, or 20.0 mm of deformation occurs. Stop the test and record the maximum load ( $P_{\text{gauge}}$ ) (Note 11.4).
- 8.9 Remove the upper metal end plate block and bearing plate.
- 8.10 Remove the specimen from the Texas triaxial cell.
- 8.11 Break up the specimen and determine the moisture content ( $w_a$ ) of the whole specimen after testing in accordance with Test Method AS 1289.2.1.1.
- 8.12 Compact additional specimens in accordance with Steps 7.2.1 to 7.2.6 until specimens have been tested at the three additional normal stresses ( $\sigma_3'$ ) of 30, 60 and 90 kPa in accordance with Steps 8.2 to 8.11.

## 9 Calculations

Calculations shall be as follows:

- 9.1 Using the achieved moisture content, calculate the achieved dry density, achieved relative compaction and achieved relative moisture content for the specimen in accordance with Test Method Q145A.

9.2 Compare the achieved dry density and target dry density. If they differ by more than 0.02 t/m<sup>3</sup>, discard the specimen, and repeat the preparation to Q145A for the nominated conditions.

9.3 Compare the achieved moisture content and the target moisture content. If they differ by more than 0.2%, discard the specimen, and repeat the preparation to Q145A for the nominated conditions.

#### 9.4 Strain and stress

9.4.1 Calculate the axial failure strain for each specimen as follows:

$$S = \frac{d_{\text{fail}}}{h}$$

where  $S$  = axial failure strain (%)  
 $d_{\text{fail}}$  = total vertical axial deformation at failure (mm)  
 $h_s$  = height of original specimen (mm)

9.4.2 Calculate the total vertical load at failure as follows (Note 11.5):

$$P = P_{\text{gauge}} \frac{(9.81M_D)}{1000} \text{ max}$$

where  $P_{\text{max}}$  = total vertical load on the specimen at failure (kN)  
 $P_{\text{gauge}}$  = maximum applied load measured by the load gauge (kN)  
 $M_D$  = combined mass of the upper metal plate block and the bearing plate (g)

9.4.3 Calculate the corrected maximum vertical stress at failure strain as follows:

$$\sigma'_1 = \frac{4P_{\text{max}}}{\pi d_s^2} (1-S)$$

where  $\sigma'_1$  = corrected maximum vertical stress at failure (kPa)  
 $P_{\text{max}}$  = total vertical load on the specimen at failure (kN)  
 $S$  = axial failure strain (%)  
 $d_s$  = diameter of the end of the cylindrical specimen at the beginning of the test (m<sup>2</sup>)

#### 9.5 Mohr's envelope of failure

9.5.1 Each specimen tested provides one pair of values ( $\sigma'_1, \sigma'_3$ ). Calculate the co-ordinates of the point of maximum shear stress ( $p', q'$ ) for each Mohr's circle as follows (Note 11.6):

$$p' = \frac{(\sigma'_1 + \sigma'_3)}{2}$$

$$q' = \frac{(\sigma'_1 - \sigma'_3)}{2}$$

where  $p'$  = normal stress at the centre of Mohr's circle (kPa)  
 $q'$  = maximum shearing stress (kPa)  
 $\sigma'_1$  = corrected maximum vertical stress at failure (kPa)  
 $\sigma'_3$  = normal stress (kPa)



- 9.5.2 Determine the linear correlation of the failure envelope based on the maximum shear stress points on the Mohr's diagram. Compute the shear stress intercept ( $a$ ), angle of slope ( $\alpha$ ) and the correlation coefficient ( $r$ ) as follows:

$$a = \frac{\sum p_i'^2 \sum q_i' - (\sum p_i')(\sum p_i' q_i')}{n \sum p_i'^2 - (\sum p_i')^2}$$

$$\alpha = \tan^{-1} \left[ \frac{n \sum p_i' q_i' - (\sum p_i')(\sum q_i')}{n \sum p_i'^2 - (\sum p_i')^2} \right]$$

$$r = \frac{n \sum p_i' q_i' - \sum p_i' \sum q_i'}{\sqrt{[n \sum p_i'^2 - (\sum p_i')^2] \cdot [n \sum q_i'^2 - (\sum q_i')^2]}}$$

- where
- $a$  = shear stress intercept of the linear correlation on the Mohr's diagram (kPa)
  - $\alpha$  = angle of slope of the linear correlation on the Mohr's diagram ( $^\circ$ )
  - $r$  = correlation coefficient
  - $p'$  = normal stress at the centre of Mohr's circle (kPa)
  - $q'$  = maximum shearing stress (kPa)
  - $i$  = the  $i^{\text{th}}$  result for test series numbered from 1 to  $n$
  - $n$  = number of ( $p'$ ,  $q'$ ) pair (that is, conforming tests)

- 9.5.3 If  $r < 0.99$ , examine the Mohr's circles and investigate the specimen moulding details, that is, moisture content and dry density, to determine whether a result can be justifiably removed from the analysis. Where a result is removed from the analysis note the justification and repeat Step 9.5.2 (Note 11.7).

- 9.5.4 Repeat the whole series if the resulting analysis has an  $r < 0.99$ .

- 9.5.5 Calculate the angle of shear resistance ( $\phi_u$ ) and apparent cohesion of the material ( $C_u$ ) as follows:

$$\phi_u = \sin^{-1}(\tan \alpha)$$

$$C_u = \frac{a}{\cos(\phi_u)}$$

- where
- $\phi_u$  = angle of shear resistance ( $^\circ$ )
  - $C_u$  = apparent cohesion of the material (kPa)
  - $\alpha$  = angle of slope of the linear correlation on the Mohr's diagram ( $^\circ$ )
  - $a$  = shear stress intercept of the linear correlation on the Mohr's diagram (kPa)

## 9.6 Mean compressive modulus

- 9.6.1 The compressive modulus for each test carried out is determined as follows:

- a) Calculate the values and plot the axial stress ( $\sigma'$ ) and axial strain ( $S$ ) relationship for a specimen.
- b) Calculate the compressive modulus as the slope of the linear section of the stress-strain relationship. However, if the stress-strain relationship is not linear, the compressive modulus is the slope of the straight line joining the point of zero axial strain to the point on the plot corresponding to 0.75% of the maximum axial strain ( $S$ ).
- c) Repeat Steps 9.6.1 a) to b) for each specimen in the series.

9.6.2 The compressive modulus for each series of tests is the mean value of the compressive moduli from each test.

### **9.7 Classification of Material**

9.7.1 Plot the Mohr's envelope of failure  $\tau_u = C_u + \sigma_n \tan(\phi_u)$  on the Texas triaxial classification chart (refer to TfNSW Test Method T171 Appendix A).

9.7.2 Classify the material as the Texas classification that is approximately tangential to the failure envelope. When the envelope of the failure falls between Texas classes, interpolate the classification to the nearest one-tenth of a classification (refer to TfNSW Test Method T171 Appendix A.1).

### **9.8 Interpolation of Texas Classification Number**

9.8.1 When the envelope of failure is located within a Texas Classification, the classification number is to be interpolated using the graphical procedure in TfNSW Test Method T171 Appendix A.2.

## **10 Reporting**

The following shall be reported:

10.1 Moisture/density relationship results:

- a) MDD to the nearest 0.01 t/m<sup>3</sup>
- b) OMC to the nearest 0.5%

10.2 Compaction results:

- a) The following in accordance with Test Method Q145A:
  - i. nominated relative compaction and nominated relative moisture content
  - ii. target dry density and target moisture content
- b) Compaction standard used, that is standard or modified.

10.3 Texas triaxial results for the sample:

- a) Angle of shearing resistance ( $\phi_u$ ) to nearest 0.1°
- b) Apparent cohesion ( $C_u$ ) to nearest 0.1 kPa
- c) Mean compressive modulus to nearest 0.1 MPa
- d) Percent retained on 37.5 mm test sieve to nearest 1%
- e) Texas classification number to nearest 0.1.

10.4 Compaction results, for each specimen, for the following normal stresses; 10, 30, 60 and 90 kPa:

- a) The following in accordance with Test Method Q145A:
  - i. achieved dry density, achieved moisture content, and
  - ii. achieved relative compaction and achieved percentage of OMC as detailed in Test Method Q145A
- b) moisture content after testing ( $w_3$ ) to nearest 0.1%.

- 10.5 Texas triaxial results, for each specimen, for the following normal stresses; 10, 30, 60 and 90 kPa:
  - a) compressive modulus to nearest 0.1 MPa.
- 10.6 Any comment where removal of a result in determining the correlation in Step 9.5.3 is undertaken, and
- 10.7 The number of this Test Method, that is Q257.

## 11 Notes on method

- 11.1 A material height gauge, which allows monitoring of the height of compacted material relative to the top of a Texas Triaxial mould, can be made from a steel bar and marked as follows:
  - 11.1.1 Commencing at one end of the bar, measure and mark distances of:
    - a) 5.5 mm for the upper range of the fifth layer
    - b) 40.5 mm and 45.5 mm for the acceptable range of the fourth layer
    - c) 81.5 mm and 86.5 mm for the acceptable range of the third layer
    - d) 122.5 mm and 127.5 mm for the acceptable range of the second layer, and
    - e) 162.5 mm and 167.5 mm for the acceptable range of the first layer.
  - 11.1.2 Mark the face with the appropriate mould size (T).
- 11.2 Before handling oils, the operator should consult the relevant SDS.
- 11.3 For fragile materials the internal dimensions of the mould may be measured to avoid damaging the compacted specimen.
- 11.4 Failure is reached when the load gauge readings remain constant or decrease with further increments of deformation.
- 11.5 A correction is necessary because the area of the cross-section increases as the specimen is deformed. The assumption is that the specimen deforms at constant volume.
- 11.6 Usually there will be 4 maximum shear stress points ( $p'$ ,  $q'$ ) corresponding to the four normal stresses of 10, 30, 60 and 90 kPa.
- 11.7 Only one point may be removed from the analysis.

**Table 1 – Dimensions and tolerances for suitable moulds and rammer**

Apparatus	Dimension	Tolerance
<b>CBR machine</b>		
Sample deformation rate (mm/min)	4.1	± 0.5
<b>Mould</b>		
Internal diameter (mm)	153.0	± 0.5 *
Effective height (mm)	203.0	± 0.5 *
Nominal volume (cm <sup>3</sup> )	3730	± 25
<b>Rammer</b>		
Diameter; round foot (mm)	50	± 0.4
Area of rammer (mm <sup>2</sup> )	1964	± 31

Apparatus	Dimension	Tolerance
Drop (mm)	300	± 2.0 ‡
Mass (kg)	2.7	± 0.01 ‡

\*Either but not both of the tolerances may be exceeded provided the specified tolerance on volume is not exceeded.

‡ Either but not both of the tolerances may be exceeded provided the appropriate tolerance on energy delivered per blow is not exceeded.

## Test Method Q258A: Dynamic modulus of deformation – light falling weight device – accelerometer type

### 1 Source

This Test Method is based on ASTM E2835: *Standard Test Method for Measuring Deflections using a Portable Impulse Plate Load Test Device* and TP BF-StB Part B 8.3: *Dynamic Plate Load Testing with the Light Drop Weight Tester*.

### 2 Scope

This Test Method describes the procedure to determine dynamic modulus of deformation of a soil

The test involves the soil receiving an impact of maximum force transmitted through the fall of a drop weight onto a circular load plate of radius  $r$  that is assumed to be rigid. Force is selected during calibration, by adjusting the drop height, so the maximum normal stress under the load plate is 0.1 MPa during the test. The resulting deflections are measured at the centre of the top of the load plate. These deflections are used to calculate the dynamic modulus of deformation ( $E_{vd}$ ).

The data may be used for quality control of compacted layers of earthworks with fine and coarse grained materials up to a maximum particle size of 63 mm. It is suitable for materials with a dynamic modulus of deformation in the range of 15–70 MPa. It is not a replacement for proof rolling.

### 3 Apparatus

Where appropriate, the working tolerances of apparatus are contained in Table 1. Examples of the apparatus are shown in TP BF-StB Part B 8.3: *Dynamic Plate Load Testing with the Light Drop Weight Tester* Figure 2 (Note 10.1).

The following apparatus is required:

#### 3.1 Light drop weight tester as follows:

- a) Force generating device (falling mass), 10 kg, capable of being raised to a pre-determined fixed height and dropped onto a steel spring assembly. Providing a maximum impact force of 7.07 kN. The resulting force pulse transmitted to the surface shall provide a half-sine or haversine-shaped load pulse with a time of loading of 17 ms and produce a peak load with a resolution of 0.1 kN.
- b) Load plate, 300 mm diameter, 20 mm thick and mass of 15 kg, rigid and capable of transferring the impulse load to the surface.
- c) Deflection sensor, attached to the centre of the load plate, capable of measuring the maximum vertical plate movement in the range of 0.3 mm to 1.5 mm with a resolution of 0.02 mm. The instrument shall be constructed to measure the vertical plate deflection at the centre of the point of impact.
- d) Data processing and storage system, able to store and display load and deflection data. The peak load and deflection measurements are to be recorded within a time of 50 ms or longer.

#### 3.2 Suitable tools for levelling and smoothing the material surface.

#### 3.3 For checking the device:

- a) steel rule, one metre long, with a resolution not exceeding one mm

- b) rigid and level base, with a total mass not less than 200 kg, for example, concrete floor; the same base must be used for the duration of the calibration
- c) base plate, steel, 340 mm diameter and mass of 30 kg, rigid and capable of transferring the impulse load to the rubber; must be able to be attached to the load plate with a quick clamping device, and
- d) rubber mats, at least one capable of providing a one mm settling. Mats 500 mm square with thickness three mm, 10 mm and 25 mm, hardness of 60 IRHD and conforming to AS 5100.4 have been found to be suitable.

## 4 Materials

The following materials are required:

- 4.1 Fines, dry fine sand or dry native fines passing a 0.600 mm test sieve.

## 5 Calibration

Undertake calibration of the force generating device and deflection sensors at least once every 12 months using the procedure in TP BF-StB Part B 8.3: *Calibration Rules for the Light and Medium Drop Weight Tester* (Note 10.2). When the device is returned from calibration, undertake the check in Section 6 and record the mean of the maximum settlement of the load plate under load ( $s_{\max}$ ) from the 10 drops as the reference settlement value.

## 6 Operational checks

To ensure the device is operating normally, the checks are to be undertaken before use as follows:

### 6.1 Verification (frequency: daily before use)

- 6.1.1 Remove the device from carry case and place near the base.
- 6.1.2 Using the steel rule, measure the drop height of the device. Compare the measured drop height and the drop height recorded on the calibration certificate. If necessary, adjust the drop height to match the drop height recorded on the calibration certificate.
- 6.1.3 Sweep the surface clean and place the rubber mat on the base.
- 6.1.4 Using quick clamps, attach the base plate to the load plate.
- 6.1.5 Perform 10 drops in accordance with Steps 7.6.1 to 7.6.5
- 6.1.6 Using the 10 resulting maximum settlement of the load plate under load ( $s_{\max}$ ) determine the minimum and maximum values and the mean value.
- 6.1.7 Compare the minimum and maximum values from Step 6.1.6, and if they differ by more than 0.04 mm remove the device from service for calibration.
- 6.1.8 Compare the mean value from Step 6.1.6 with the reference settlement value from Section 5, and if the absolute difference is more than 0.02 mm remove the device from service for calibration.

### 6.2 Checking drop height (frequency: before use on site)

- 6.2.1 Remove the device from carry case.
- 6.2.2 Using the steel rule, measure the drop height of the device. Compare the measured drop height and the drop height recorded on the calibration certificate.

- 6.2.3 If the drop height needs adjustment, perform the verification in accordance with Subsection 6.1. If the device does not pass verification, remove the device from service for calibration.

## 7 Procedure

The procedure shall be as follows:

- 7.1 Remove any loose material and vegetation from around the test site to create a flat and level surface to undertake the test. The site should be 1.5 times larger than the diameter of the load plate.
- 7.2 Sweep all loose material from the test site and sprinkle fine sand or native fines on the surface, then smooth the surface.
- 7.3 Place the load plate on the prepared test location.
- 7.4 Rotate the load plate left and right to an angle of 45 degrees.
- 7.5 Perform three falling mass drops for seating, with the procedure for each drop as follows:
- Raise the falling mass to the pre-set drop height and secure into release mechanism.
  - Adjust guide rod to vertical.
  - Release falling mass and allow to fall freely.
  - Catch the falling mass after rebound.
  - Record the resulting maximum settlement of the load plate under load ( $s_{\max}$ ) and maximum deformation speed of the load plate under impact load ( $v_{\max}$ ).
  - If the load plate tilts, the seating deflections ( $s_{\max}$ ) differ from one another by more than 10 percent, a faulty drop occurs, the load plate is displaced, or the guide rod moves, then the test is not valid. Position the test device at a new location and start the test procedure from Step 7.1. Testing cannot be repeated at the same location.
- 7.6 Perform three falling mass drops for analysis, with the procedure for each drop as follows:
- Raise the falling mass to the pre-set drop height and secure into release mechanism.
  - Adjust guide rod to vertical.
  - Release falling mass and allow to fall freely.
  - Catch the falling mass after rebound.
  - Record the resulting maximum settlement of the load plate under load ( $s_{\max}$ ) and maximum deformation speed of the load plate under impact load ( $v_{\max}$ ).
- 7.7 If the load plate tilts, a faulty drop occurs, the load plate is displaced, or the guide rod moves, then the test is not valid. Position the test device at a new location and start the test procedure from Step 7.1. Testing cannot be repeated at the same location.
- 7.8 If required, obtain a sample of the soil and determine the moisture content in accordance with Test Method AS 1289.2.1.1 or record the moisture condition of the soil (dry, moist, wet).

## 8 Calculation

Calculations shall be as follows:

- 8.1 Calculate the mean deformation speed of the load plate under impact load from Step 6.6 as follows:

$$v_{\max} = \frac{v_{\max1} + v_{\max2} + v_{\max3}}{3}$$

- where  $v_{\max}$  = mean deformation speed of the load plate under impact load (mm/s)  
 $v_{\max1}, v_{\max2}, v_{\max3}$  = maximum deformation speed of the load plate under impact load (mm/s)

- 8.2 Calculate the mean maximum settlement of the load plate under load from Step 6.6 as follows:

$$s_{\max} = \frac{s_{\max1} + s_{\max2} + s_{\max3}}{3}$$

- where  $s_{\max}$  = mean maximum settlement of the load plate under load (mm)  
 $s_{\max4}, s_{\max5}, s_{\max6}$  = maximum settlement of the load plate under load from mass drops 4, 5 and 6 (mm)

- 8.3 Calculate the impact duration as follows:

$$s/v = \frac{s_{\max}}{v_{\max}} 1000$$

- where  $s/v$  = impact duration (ms)  
 $s_{\max}$  = mean maximum settlement of the load plate under load (mm)  
 $v_{\max}$  = mean deformation speed of the load plate under impact load (mm/s)

- 8.4 Calculate the dynamic modulus of deformation as follows:

$$E_{vd} = 1.5 r \frac{\sigma_{\max}}{s_{\max}}$$

- where  $E_{vd}$  = dynamic modulus of deformation (MPa)  
 $r$  = radius of load plate (mm)  
 $\sigma_{\max}$  = normal stress under load plate (usually 0.1 MPa)  
 $s_{\max}$  = mean maximum settlement of the load plate under load (mm)

## 9 Reporting

The following shall be reported:

- 9.1 The location at which the test was performed.  
 9.2 The date tested.  
 9.3 A description of the material tested.  
 9.4 Test device details, such as make, model and serial number.  
 9.5 Test configuration details, such as plate diameter.



- 9.6 A tabulation of maximum settlement to the nearest 0.001 mm and maximum deformation speed to the nearest 0.1 mm/s for each drop (Step 7.6).
- 9.7 Impact duration to the nearest 0.001 ms.
- 9.8 Dynamic modulus of deformation to the nearest one MPa.
- 9.9 Moisture content of the soil or the moisture condition of the soil, that is, wet, moist or dry, if required.
- 9.10 The number of this Test Method, that is Q258A.

## 10 Notes on method

- 10.1 This method is suitable for devices such as the Zorn ZFG 3000, HMP LFG, Terratest 4000, Terratest 5000 and Olsen LWD-1.
- 10.2 Until a NATA-accredited calibration facility is available in Australia, or devices are unable to be calibrated in Australia, a calibration agency accredited by the German Federal Highway Research Institute (BAST) will be acceptable. The calibration frequency would remain at 12 months.

**Table 1 – Test apparatus requirements**

Apparatus	Requirement	Tolerance
Falling mass		
Mass (kg)	10.00	± 0.10
Maximum impact force (kN)	7.07	See Note
Duration of impact (ms)	17	± 1.5
Guide rod		
Mass (kg)	5.00	± 0.10
Load plate		
Diameter (mm)	300.0	± 0.5
Plate thickness (mm)	20.0	± 0.2
Mass (kg)	15.00	± 0.25

Note: Maximum impact force is defined by adjusting the drop height during calibration. The duration of impact is adjusted during calibration.

## Test Method Q258B: Surface modulus – Light weight deflectometer (LWD) – load cell type

### 1 Source

This Test Method is based on ASTM E2583: *Standard Test Method of Measuring Deflections with a Light Weight Deflectometer (LWD)*, and Fleming PR, Edwards JP (2013) *LWD Best Practice Guide*, Loughborough University, Institutional Repository.

### 2 Scope

This Test Method describes the procedure to determine surface modulus of a soil.

The test involves the soil receiving an impact of force transmitted through the fall of a drop weight onto a circular load plate of radius  $r$  that is assumed to be rigid. Force is measured by a load cell and the resulting deflections are measured by a sensor that rests on the material surface through a hole in the load plate. The force and deflections are used to calculate the surface modulus ( $E_o$ ).

These data may be used for quality control of compacted layers of earthworks with fine and coarse-grained materials up to a maximum particle size of 63 mm. It is suitable for materials with a surface modulus in the range of 15–70 MPa. It is not a replacement for proof rolling.

### 3 Apparatus

The following apparatus is required:

#### 3.1 Light weight deflectometer (Note 8.1) as follows:

- a) Force generating device (falling mass), 10 kg, capable of being raised to a pre-determined height, dropped and able to fall freely. The resulting force pulse transmitted to the surface shall provide a half-sine or haversine-shaped load pulse with a time of loading between 20–40 ms and produce a peak load with a resolution of 0.1 kN.
- b) Load plate, 300 mm diameter, capable of uniformly distributing the impulse load across the material surface. The load plate must be able to allow pavement deflection measurement at the centre of the point of impact through a hole in the plate.
- c) Deflection sensor, capable of measuring the maximum vertical movement and mounted to maximise angular rotation with respect to its measuring plane at the maximum expected deflection and a resolution of 0.001 mm and a working range of 0 to 2 mm. Sensors may be of several types, such as displacement transducers, velocity transducers and accelerometers.
- d) Spring element, to provide a controlled transient pulse length to the impact force, typically of the range of 16–30 ms. The spring element is typically a series of rubber cones / buffers, or a cylindrical pad system.
- e) Data processing and storage system, able to store and display load and deflection data. The peak load and deflection measurements are to be recorded within a time of 60 ms or longer. Supporting information such as air temperature, surface temperature, location identification and test identification data for each test point.
- f) Load cell, capable of measuring the applied load at impact. Placed in a position to minimise the mass between the load cell and the surface. The load cell is positioned in such a way that it does not restrict the ability to obtain deflection measurements under the centre of the load plate.

3.2 Suitable tools for levelling and smoothing the material surface.

## **4 Calibration and checking**

### **4.1 Force generating device**

Prior to load and displacement sensor calibration, precondition the device by dropping the falling mass at least five times and checking the relative difference in each peak load level. Peak load levels measured by the load cell shall not vary by more than  $\pm 3\%$ . If the variation exceeds this tolerance, the height of the drop, cleanliness of the guide, along with any springs or rubber pads used to condition the load, should be checked and replaced as required.

### **4.2 Load calibration platform**

Undertake calibration and checking of the load cell in accordance with the procedures and requirements stated in the manufacturer's user manual every 12 months (Note 8.2).

### **4.3 Deflection sensors**

Undertake calibration and checking of the deflection sensor(s) in accordance with the procedures and requirements stated in the manufacturer's user manual every 12 months (Note 8.2).

## **5 Procedure**

The procedure shall be as follows:

- 5.1 Prior to the start of testing, precondition the device by dropping the falling mass at least five times.
- 5.2 Remove any loose material and vegetation from around the test site to create a flat and level surface to undertake the test.
- 5.3 Sweep all loose material from the test site.
- 5.4 Place the LWD over the desired test location.
- 5.5 Place the loading plate and sensors to ensure they are resting on a firm and stable surface.
- 5.6 Adjust the release mechanism to the selected height (Notes 8.3 and 8.4).
- 5.7 Perform three falling mass drops for seating with the procedure for each drop as follows:
  - 5.7.1 Raise the falling mass to the drop height and secure into release mechanism.
  - 5.7.2 Adjust guide rod to vertical.
  - 5.7.3 Release falling mass and allow to fall freely.
  - 5.7.4 Catch the falling mass after rebound.
  - 5.7.5 Record the resulting maximum deflection ( $d_o$ ) and maximum contact ( $\sigma_o$ ).
  - 5.7.6 If the load plate tilts, a faulty drop occurs, the load plate is displaced, or the guide rod moves, then the test is not valid. Position the test device at a new location and start the test procedure from Step 5.2. Testing cannot be repeated at the same location.
- 5.8 Perform three falling mass drops for analysis, with the procedure for each drop as follows:
  - 5.8.1 Raise the falling mass to the drop height and secure into release mechanism.
  - 5.8.2 Adjust guide rod to vertical.
  - 5.8.3 Release falling mass and allow to fall freely.

- 5.8.4 Catch the falling mass after rebound.
- 5.8.5 Record the resulting maximum deflection ( $d_o$ ) and maximum contact stress ( $\sigma_o$ ).
- 5.8.6 If the load plate tilts, a faulty drop occurs, the load plate is displaced, or the guide rod moves or there is difference greater than 3% maximum contact stress ( $\sigma_o$ ) then the test is not valid. Position the test device at a new location and start the test procedure from Step 5.2. Testing cannot be repeated at the same location.
- 5.9 Perform additional tests in accordance with Step 5.8 at the same or different load levels as required.
- 5.10 If required, obtain a sample of the soil and determine the moisture content in accordance with Test Method AS 1289.2.1.1 or record the moisture condition of the soil.

## 6 Calculation

Calculations shall be as follows:

- 6.1 Calculate the surface modulus as follows:

$$E_o = \frac{f(1-\nu^2)\sigma_o a}{d_o}$$

where	$E_o$	=	surface modulus (MPa)
	$f$	=	plate rigidity factor (two for standard plate)
	$\nu$	=	Poisson's ratio (normally 0.35)
	$\sigma_o$	=	maximum contact stress (kPa)
	$a$	=	plate radius (m)
	$d_o$	=	maximum deflection (mm)

## 7 Reporting

The following shall be reported:

- 7.1 The location at which the test was performed, and the reduced level of the layer tested.
- 7.2 The date tested.
- 7.3 A description of the material tested.
- 7.4 Test device details, such as make, model, and serial number.
- 7.5 Test configuration details, such as plate diameter, Poisson's ratio used and plate rigidity factor.
- 7.6 Maximum contact stress to the nearest 0.01 kPa.
- 7.7 Maximum deflection to the nearest 0.001 mm.
- 7.8 Surface modulus to the nearest one MPa.
- 7.9 Moisture content of the soil or the moisture condition of the soil, that is, wet, moist or dry, if required.
- 7.10 The number of this Test Method, that is Q258B.

## **8 Notes on method**

- 8.1 This method is suitable for devices such as the Dynatest 3032, Prima 100 and Terratest 9000 LWD.
- 8.2 This will usually require the device to be returned to the manufacturer for calibration.
- 8.3 The test parameters can be based on a nominated drop height to control the maximum contact stress or by using drop height trial and error to control the range of maximum deflection measured.
- 8.4 For earthworks a target contact stress of 100 kPa is normally used.

## Test Method Q160: Water repellency of soil (hydrophobicity)

### 1 Source

This Test Method applies the principles of the Water Drop Penetration Time (WDPT) test developed by van't Woudt BD (1959) *Particle coatings affecting the wettability of soils*, Journal of Geophysical Research, 64(2) 263–267.

### 2 Scope

This Test Method sets out the procedure for determining water repellency (hydrophobicity) by using the water drop penetration time (WDPT1) test.

A measured amount of water in droplets is applied to a dried, smoothed, levelled and uncompacted soil surface and the time that lapses before the droplets are absorbed is determined (Note 7.1).

### 3 Apparatus

The following apparatus is required:

- 3.1 Drying oven, of suitable capacity, capable of heating a sample of soil to  $40 \pm 2^\circ\text{C}$ .
- 3.2 Tray, suitable size for drying soil.
- 3.3 Standard medicine dropper.
- 3.4 Stopwatch.

### 4 Materials

The following materials are required:

- 4.1 Deionised or distilled water.

### 5 Procedure

The procedure shall be as follows:

- 5.1 Obtain a test portion of soil with a minimum volume of 300 mL.
- 5.2 Place the test portion on a tray and level to a smooth but uncompacted surface.
- 5.3 Place the test portion and tray in the oven and dry to a constant mass (Note 7.2).
- 5.4 Remove the test portion and tray from the oven and allow to cool to room temperature.
- 5.5 Using the standard medicine dropper, apply three separated water droplets to the surface of the test portion.
- 5.6 Determine the time it takes for the water to infiltrate (disappear) into the test portion and record as the water drop penetration time to the nearest second.

### 6 Reporting

The following shall be reported:

- 6.1 Water drop penetration time to the nearest one second.
- 6.2 Water repellence class (Table 1).
- 6.3 Water repellence rating description (if required).

6.4 The number of this Test Method, that is Q160.

## 7 Notes on method

7.1 For further information and forms for recording test data, refer to Department of Transport and Main Roads (2020), *Soil Management Manual*. Specifically, Table 9.6.2 and Appendix 2 *Soil Testing Forms*.

7.2 Constant mass is achieved when, after the initial drying period, successive drying over one hour periods gives rise to a weight loss of not more than 1% of the initial weight loss.

**Table 1 – Soil water repellence class**

Class	WDPT (seconds)	Water repellence rating
0	< 5	wettable; non-water repellent
1	5 – 60	slightly water repellent
2	> 60	strongly water repellent

## Test Method Q161: Soil aggregate test – slaking

### 1 Source

This Test Method is based on the procedure described in the NSW Department of Primary Industry, (1999) *SOILpak – Southern Irrigators – Readers' Note – Part C. Diagnosis of Soil, Chapter C7. Slaking and Dispersion*, Department of Primary Industry, New South Wales (Note 9.1).

### 2 Scope

This Test Method describes the procedure for determining slaking of a soil. Slaking is the breakdown of air-dry soil aggregates into smaller micro-aggregates and primary particles (for example, coarse sand) of a soil (ped) on rapid wetting (when placed in deionised water).

### 3 Background

Slaking indicates a soils resistance to erosion and how well it maintains its structure when wetted by immersing in deionised water. Slaking occurs when soil aggregates are not strong enough to withstand internal stresses caused by rapid water uptake. Internal stresses result from differential swelling of clay particles, and trapped and escaping air in soil pores.

Slaking of topsoils result in detached soil particles that fill soil pores and cause surface sealing – reducing infiltration and plant available water; and increasing runoff and erosion. Slaking of subsoils and extremely weathered (soil-like) material exposed in cuts results in detached particles (sediment) settling in drains and receiving waterbodies.

Slaking is affected by soil water content, wetting rate, soil texture, type of clay (minerology) and organic matter (the latter relevant for topsoils).

Slaking is increased by fast wetting rates, particularly when soil is initially dry. Moist aggregates slake less readily than air-dry aggregates because they have already completed some or all of their swelling and some pores are already filled with water. The pressure of entrapped air is the primary factor for causing slaking of loamy soils, while clay is associated with slaking cause by soil swelling (Notes 9.1 and 9.2)

### 4 Apparatus

The following apparatus is required:

- 4.1 Clear petri dish or similar.

### 5 Materials

The following materials are required:

- 5.1 Deionised or distilled water.

### 6 Procedure

The procedure shall be as follows:

- 6.1 From the representative soil sample select three soil aggregates of 5 – 10 mm diameter.
- 6.2 If moist, air dry the aggregates.
- 6.3 Fill a petri dish with deionised or distilled water, deep enough to cover the soil aggregates.
- 6.4 Carefully place the three separated soil aggregates into the water so they are spaced apart.



- 6.5 Do not knock, disturb or place the petri dish in a windy position.
- 6.6 Observe each of the soil aggregates behaviour immediately, within five minutes and at two hours and determine the slaking class, for each aggregate, using Table 1.
- 6.7 Record the presence of slaking of each aggregate. Soil is slaking even if only one ped slakes.

**7 Calculations**

Calculation shall be as follows:

- 7.1 The highest class value from the three aggregates at 120 minutes and record as the slaking class for the representative soil sample.

**8 Reporting**

The following shall be reported:

- 8.1 Slaking class.
- 8.2 The number of this Test Method, that is Q161.





**9 Notes on method**

- 9.1 For further information and forms for recording test data, refer to Department of Transport and Main Roads, *Soil Management Manual*. Specifically, Sections 6.4.1, 8.4.1 and Appendix 2 *Soil Testing Forms*.
- 9.2 The slaking classes have been adapted from the Department of Primary Industry (1999) *SOILpak – Southern Irrigators – Readers' Note – Part C: Diagnosis of Soil*, Chapter C7. *Slaking and Dispersion*, Department of Primary Industry, New South Wales.

**Table 1 – Slaking class**

Class	Aggregate description	Rating within five minutes	Rating at 120 min.
0	No slaking (ped intact)	None	None
1	Slight edge breakdown (ped mostly intact)	Slow	Very slow
2	Collapses into angular pieces (ped cone shaped)	Moderate	Slow
3	Collapses into finer < 2 mm pieces (ped slightly evident)	Fast	Moderate
4	Complete breakdown into micro-aggregates (ped not evident)	Rapid	Moderately fast

Ped remains intact				
Rating 0	Rating 1	Rating 2	Rating 3	Rating 4

## Test Method Q162: Soil aggregate test – clouding

### 1 Source

This Test Method is based on the procedure described in the Department of Primary Industry (1999) *SOILpak – Southern Irrigators – Readers’ Note – Part C. Diagnosis of Soil, Chapter C7. Slaking and Dispersion*; Department of Primary Industry, New South Wales.

### 2 Scope

This Test Method describes the procedure for determining clouding (dispersion) of a soil (Note 9.1). Clouding is the separation of individual clay particles, of a soil (ped) on wetting (placed in deionised water).

### 3 Background

Soil can disperse due to physical inputs including rainfall impact and disturbance by earthworks machinery. It can also disperse due to chemical soil properties, when a high concentration of sodium is attached to the clay particles of a soil.

In the context of the department, chemically caused dispersion is what is meant by the term *dispersion*. It is considered a high-risk soil property and, as such, is tested for using this method (and other associated Test Methods).

A soil with a high concentration of sodium is described as *sodic* and its condition is referred to as *sodicity* (or *ESP – Exchangeable Sodium Percentage*). *Dispersion* is an indicator of sodic soil when wetted. Note that the terms *sodic* and *dispersion* are interchangeable in the department's context.

When a sodic (dispersive) soil contacts a non-saline water, water is drawn between the clay layers causing the clay to swell, causing individual clay layers to disperse from the soil aggregate.

Dispersion causes soil aggregates to break down, due to the separation of clay particles, resulting in the clogging of soil pores by the dispersed clay particles. The dispersed and suspended particles can be seen as *milky* water in drains, basins and puddles (Note 9.2).

### 4 Apparatus

The following apparatus is required:

- 4.1 Clear petri dish or similar.

### 5 Materials

The following materials are required:

- 5.1 Deionised or distilled water (Note 9.3).

### 6 Procedure

The procedure shall be as follows:

- 6.1 From the representative soil sample select three soil aggregates of 5–10 mm diameter.
- 6.2 If moist, air dry the aggregates.
- 6.3 Fill a petri dish with deionised or distilled water, deep enough to cover the soil aggregates.
- 6.4 Carefully place the three separated soil aggregates into the water so they are spaced apart.

- 6.5 Do not knock, disturb or place the petri dish in a windy position.
- 6.6 Observe each of the soil aggregates behaviour immediately, within five minutes and at two hours and determine the clouding class, for each aggregate, using Table 1 (Note 9.4), and
- 6.7 Record the presence of clouding around each aggregate, regardless if the soil ped slakes, collapses or bubbles. Soil is dispersive even if only one ped clouds.

## 7 Calculations

Calculation shall be as follows

- 7.1 The highest class value of the three aggregates at 120 minutes and record as the clouding class for the representative soil sample.

## 8 Reporting

The following shall be reported:

- 8.1 Clouding class.
- 8.2 The number of this Test Method, that is Q162.





## 9 Notes on method

- 9.1 The descriptive term *clouding* directly relates to dispersion.
- 9.2 For further information and forms for recording test data, refer to Department of Transport and Main Roads, *Soil Management Manual*. Specifically, Sections 6.4.2, 8.4.2 and Appendix 2 *Soil Testing Forms*.
- 9.3 Dispersion only occurs in non-saline water or rainwater with an EC < 0.001 dS/m; hence the use of deionised or distilled water for testing for clouding.
- 9.4 The clouding classes have been adapted from the Department of Primary Industry (1999) *SOILpak – Southern Irrigators – Readers' Note – Part C. Diagnosis of Soil, Chapter C7. Slaking and Dispersion*, Department of Primary Industry, New South Wales.

**Table 1 – Clouding class**

Class	Aggregate description	Rating at five minutes	Rating at 120 minutes
0	No clouding / dispersion (ped intact)	None	None
1	Slight edge clouding (ped mostly intact)	Slow	Very slow
2	Moderate clouding (ped slightly less evident)	Moderate	Slow
3	Considerable clouding (ped approx.50% evident)	Fast	Moderate
4	Complete dispersion into individual particles (ped not evident)	Rapid	Moderately fast

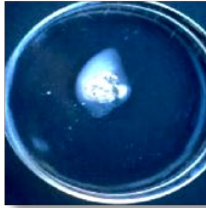
				
Rating 0	Rating 1	Rating 2	Rating 3	Rating 4

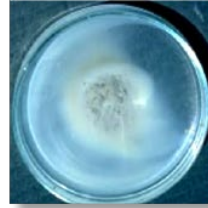
## Test Method Q163: Soil wettability

### 1 Source

This Test Method is based on the procedure described in AS 4419: *Soils for landscaping and garden use*.

Additional material referenced in Note 9.2 includes Hutcheson WL (1958), *Moisture flow induced by thermal gradients within unsaturated soils*, Special Report 40, Highway Research Board, 113-133.

### 2 Scope

This Test Method describes the procedure for determining the wettability of a soil. Soil wettability describes the ability of a soil to intake water. Soil wettability should not be confused with soil water repellency (hydrophobicity).

### 3 Background

Soil wettability is a dynamic soil property, which results from complex interactions between many other physical and chemical soil properties. *Wetting* is the ability of a liquid to maintain contact with a solid surface, resulting from intermolecular interactions when the two are brought together.

The degree of wetting (wettability) is determined by a force balance between adhesive and cohesive forces. Wetting deals with the three phases of materials: gas, liquid, and solid via the Young equation.

*Wettability* quantifies the wettability of a solid surface by a liquid. A given system of solid, liquid, and vapour at a given temperature and pressure has a unique equilibrium contact angle.

The problem of soil wettability is usually associated with hydrophobicity and water repellency; however, these phenomena occur, generally, in soils of high organic matter content and some sandy soils. Hydrophobicity develops in soils when hydrophobes surround the soil particle forming a waxy coating or intermix with minerals currently in the soil. Moisture migration through hydrophobic soil is irregular and non-uniform. The soil does not wet, and water runs off or moves through fissures and cracks.

Mineral soils, usually considered as well wettable, may differ markedly in wettability. This may be particularly important for water transport in the unsaturated zone and for distribution of the liquid / gas phases in the soil matrix. Some methods used for wettability are characterised by the thin column wicking (TCW) method.

The standard soil wettability tests such as water drop penetration time (WDPT), molarity of ethanol drop (MED) and sessile drop (SD) methods are often used (Notes 9.1 and 9.2).

### 4 Apparatus

The following apparatus are required:

- 4.1 Drying oven, of suitable capacity, capable of heating a sample of soil to  $40 \pm 2^\circ\text{C}$
- 4.2 Container or tray, suitable size for drying soil
- 4.3 Timer or stopwatch
- 4.4 Plastic funnel of 150 mm diameter
- 4.5 Test tube, graduated plastic

- 4.6 Infiltration tubes, preferably a hollow graduated falcon tube or a tube constructed from a PVC pipe, 50 mm long and 25 mm in diameter
- 4.7 Cylinder, measuring of 10 mL capacity, and
- 4.8 Steel rule.

## 5 Materials

The following material is required:

- 5.1 Deionised or distilled water.
- 5.2 Cotton wool or filter paper.

## 6 Procedure

The procedure shall be as follows:

- 6.1 Dry a sample of the soil, to a depth of approximately 30 mm, in a suitable container, to constant mass at 40°C (Note 9.3).
- 6.2 Using a 150 mm diameter plastic funnel, insert a piece of filter paper or cotton wool into the neck and suspend the funnel in a suitable container for collection of water.
- 6.3 Pour dried soil into the funnel and smooth and pat down surface.
- 6.4 Embed a hollow plastic graduated falcon tube or infiltration ring approximately 5 mm into the soil.
- 6.5 Gently pour 10 mm of water into the graduated tube
- 6.6 Start the timer and at 60 seconds determine the distance on tube graduations that water has infiltrated the soil ( $d_1$ )
- 6.7 Repeat Steps 6.2 to 6.6 with two further samples of the dried soil ( $d_2$  and  $d_3$ ).

## 7 Calculations

The calculation shall be as follows:

- 7.1 Calculate the mean of distance the water has infiltrated the soil ( $d_1$ ,  $d_2$  and  $d_3$ ), in millimetres, that has infiltrated the soil in 60 seconds.

## 8 Reporting

The following shall be reported:

- 8.1 The calculated mean millimetres of water that infiltrated the soil in 60 seconds.
- 8.2 The number of this Test Method, that is Q163.

## 9 Notes on method

- 9.1 For further information and forms for recording test data, refer to Department of Transport and Main Roads, *Soil Management Manual*. Specifically, Table 9.6.2 and Appendix 2 *Soil Testing Forms*.

9.2 Water moves through a soil in response to the various forces acting upon it. Among these are the pressure-gradient, gravitational, adsorptive, and osmotic forces. In addition, thermal and electrical gradients may impose forces upon the water in soil and cause its movement under certain circumstances (Hutcherson, 1958). These notes primarily discuss the liquid-phase movement.

One of the basic physical relationships used to describe the flow of water in soils is a flux equation. Darcy's law, relating the flux of water  $v$  to the driving force:

$$v = -\left(\frac{K\rho}{n}\right)\nabla\phi$$

where	$K$	=	the permeability of the soil or porous medium
	$\rho$	=	the fluid density
	$n$	=	the viscosity
	$\nabla\phi$	=	the driving force per unit mass of water

The soil water potential  $\phi$  is the work per unit mass of water required to transfer the water reversibly from a reference state to the point in question in the soil. The potential gradient  $\nabla\phi$  is composed of a gravitational potential gradient and a *capillary* potential gradient. The capillary potential includes the combined effect of hydrostatic pressure in the water and the adsorption forces.

Darcy's law may also be written in terms of the hydraulic gradient:

$$v = -K\nabla H$$

In this equation	$v$	=	the volume flux of water, that is, the volume of water passing through unit cross-sectional area of soil per unit time
	$\nabla H$	=	the hydraulic gradient or the space rate of change of hydraulic head $H$ in the direction of flow
	$K$	=	the conductivity of the soil to water

The water-moving force is expressed as the negative gradient of a hydraulic head composed of gravitational and pressure head, that is:

$$H = h + Z$$

where	$h$	=	the pressure head
	$Z$	=	the gravitational head

The pressure head is numerically equal to the soil water tension or suction (Richards, 1965), but of opposite sign when the soil water tension is expressed in units of length of a column of water. The pressure head should not be interpreted as the actual pressure in the soil water, but as an equivalent pressure, that is, the pressure in a body of water which is in hydraulic equilibrium with the soil water. The body of water may be in a piezometer tube at its termination in the soil, or it may be the water inside a tensiometer cup.

- 9.3 Constant mass is achieved when, after the initial drying period, successive drying over one hour periods gives rise to a weight loss of not more than 1% of the initial weight loss.

## **10 References**

- 10.1 Hutcheson WL (1958), *Moisture flow induced by thermal gradients within unsaturated soils*, Special Report 40, Highway Research Board, 113-133.
- 10.2 Richards LA (1965) Physical Condition of Water in Soil, in Black CA (ed) (1965) *Methods of Soil Analysis. Part 1 – Physical and mineralogical methods, including statistics of measurement and sampling*, Agronomy Series 9, American Society of Agronomy, Madison, Wisconsin.



## Test Method Q164: Soil hydraulic conductivity (permeability)

### 1 Source

This Test Method is based on the procedure described by Klute A (1965) *Laboratory Measurement of Hydraulic Conductivity of Saturated Soil*, in Black CA (ed), 1965, *Methods of Soil Analysis. Part 1 – Physical and mineralogical methods, including statistics of measurement and sampling*, Agronomy Series 9, American Society of Agronomy: Madison, Wisconsin.

### 2 Scope

This Test Method describes the procedure for determining the hydraulic conductivity (permeability) of a soil. Soil hydraulic conductivity describes the ease with which a fluid (water) can move through pore spaces or fractures in soil.

### 3 Background

Hydraulic conductivity is defined as the ability of a porous medium (soil) to transmit water under saturated or close to saturated conditions. Water moves through a soil in response to the following forces acting upon it – pressure-gradient, gravitational, adsorptive, and osmotic forces.

Additionally, thermal and electrical gradients (soil mineralogy) may impose forces upon the water in soil and cause its movement under certain circumstances.

Klute (1965) discusses the basic physical relationships used to describe the flow of water in soils as a flux equation.

Darcy's law relates the flux of water  $v$  to the driving force, but Darcy's law may also be written in terms of the hydraulic gradient:

$$v = -K\nabla H$$

In this equation  $v$  = the volume flux of water, that is, the volume of water passing through a unit cross sectional area of soil per unit time

$\nabla H$  = the hydraulic gradient or the space rate of change of hydraulic head  $H$  in the direction of flow

$K$  = the conductivity of the soil to water (Notes 9.1 and 9.2).

### 4 Apparatus

The following apparatus are required:

- 4.1 Constant head permeability apparatus (Figure 1) consisting of the following:
- Permeameter cylinder, preferably constructed from two thick-walled PVC pipes, 85 mm long and 100 mm in diameter with a bottom cylinder, 85 mm long with a glued push-on end cap that has been drilled with approximately 15 holes, of five mm diameter, evenly spaced across the surface of the cap and an upper cylinder 85 mm long
  - Mesh, fine mesh gauze or shade cloth, cut into circles that neatly fit into the bases of the cylinders
  - Uniform gravel, fine (approximately < 3 mm depth) placed in the base of the bottom cylinder
  - Collecting funnel, plastic, 150 mm diameter

- e) Graduated collecting vessel, such as a clear plastic or glass beaker or similar for collecting water that has percolated through the soil in the bottom cylinder (permeameter), and
- f) Means of maintaining a constant head of water above the soil in the cylinders, such as a siphon, header tank / trough, overflow and water supply – refer to Figure 1.

4.2 Measuring cylinders, 100 mL and one L capacity

4.3 Stopwatch or timer.

4.4 Steel rule.

4.5 Sieves or screens, 10 mm and 2 mm

4.6 Water tank, of suitable capacity, capable of holding water to the height of the soil in the permeameter cylinder, and

4.7 Spatula or knife, for trimming the soil in the permeameter cylinder.

## 5 Materials

The following material is required:

5.1 Deionised or distilled water.

5.2 Filter paper, and

5.3 Electrical tape, for temporarily joining the bottom and upper cylinders.

## 6 Procedure

The procedure shall be as follows:

6.1 Sieve sample and discard material greater than 10 mm.

6.2 Sieve as much of the test sample as possible to pass a 2 mm sieve but retain all oversized material in the sample to be used in the test.

6.3 Prepare the permeameter cylinder by placing one piece of gauze in the base and covering it with 10 mm of fine gravel.

6.4 Place the upper cylinder neatly on top of the bottom cylinder and tape them together.

6.5 Place < 2 mm sieved soil into the permeameter cylinder until it fills the bottom cylinder and is about two-thirds of the way up the upper cylinder.

6.6 Drop the permeameter cylinder five times from a height of 50 mm to gently consolidate the soil.

6.7 Carefully lower the permeameter cylinder into a water tank so that the water level reaches to the top of the soil in the permeameter cylinder and leave overnight for a minimum of 16 hours.

6.8 Remove the permeameter cylinder from the water tank. Remove the tape that joins the two cylinders.

6.9 Carefully remove the upper cylinder and trim the soil back to be level with the upper edge of the bottom cylinder. Using the steel rule measure the length and diameter of the sample ( $L$ ) and ( $D$ ).

6.10 Replace the upper cylinder and join and retape them together.

6.11 Place a small piece of filter paper on top of the soil.

6.12 Return the permeameter cylinder and soil to the water tank.

- 6.13 Prepare the rest of the permeameter apparatus.
- 6.14 If using a siphon, ensure it is set up so that the level of water in the trough is level with 10 mm below the upper rim of the upper cylinder when it is positioned in the collection device.
- 6.15 Transfer the permeameter cylinder from the water tank to the permeameter apparatus (Figure 1).
- 6.16 Ensure that the level of water of constant head is level with 10 mm below the upper rim of the permeameter cylinder. Using the steel rule measure the head of water ( $H$ ).
- 6.17 If using a siphon or some regulated system, start the apparatus to maintain a constant head of water on the sample.
- 6.18 For gravelly or organic, highly-porous soils, it may not be possible to maintain a constant head of water on the sample, and such samples generally lie outside the requirements of the standard, so record as such.
- 6.19 Otherwise, for each sample of generally-conforming permeability, collect the water flowing through the sample on three occasions at suitable intervals during a 24 hour period. Using the stopwatch and measuring cylinders record the elapsed time in hours ( $t$ ) and the volume of water passing through the sample ( $V$ ). If the water is flowing from the sample is slow, collect for one hour.

## 7 Calculations

The calculation shall be as follows:

- 7.1 Calculate the hydraulic conductivity ( $K$ ) as follows:

$$K = \frac{VL}{AtH}$$

- where
- $K$  = Hydraulic conductivity (cm/hour)
  - $V$  = Volume of water passing through the soil in time ( $t$ ) (mL)
  - $L$  = Length of sample (cm)
  - $A$  = Cross sectional area of sample (cm<sup>2</sup>)
  - $t$  = Time (hours)
  - $H$  = Head of water (cm)

## 8 Reporting

The following shall be reported:

- 8.1 Hydraulic conductivity to the nearest one cm/hour.
- 8.2 The number of this Test Method, that is Q164.

## 9 Notes on method

- 9.1 For further information and forms for recording test data, refer to Department of Transport and Main Roads, *Soil Management Manual*. Specifically, Section 8.6 and Appendix 2 *Soil Testing Forms*.

9.2 Water moves through a soil in response to the various forces acting upon it. Among these are the pressure-gradient, gravitational, adsorptive, and osmotic forces. In addition, thermal and electrical gradients may impose forces upon the water in soil and cause its movement under certain circumstances (Hutcherson, 1958). These notes primarily discuss the liquid-phase movement.

One of the basic physical relationships used to describe the flow of water in soils is a flux equation. Darcy's law, relating the flux of water  $v$  to the driving force:

$$v = -\left(\frac{Kp}{n}\right) \nabla\phi$$

where	$K$	=	the permeability of the soil or porous medium
	$p$	=	the fluid density
	$n$	=	the viscosity
	$\nabla\phi$	=	the driving force per unit mass of water

The soil water potential  $\phi$  is the work per unit mass of water required to transfer the water reversibly from a reference state to the point in question in the soil. The potential gradient  $\nabla\phi$  is composed of a gravitational potential gradient and a *capillary* potential gradient. The capillary potential includes the combined effect of hydrostatic pressure in the water and the adsorption forces.

Darcy's law may also be written in terms of the hydraulic gradient:

$$v = -K\nabla H$$

In this equation	$v$	=	the volume flux of water, that is, the volume of water passing through unit cross-sectional area of soil per unit time
	$\nabla H$	=	the hydraulic gradient or the space rate of change of hydraulic head $H$ in the direction of flow
	$K$	=	the conductivity of the soil to water

The water-moving force is expressed as the negative gradient of a hydraulic head composed of gravitational and pressure head, that is:

$$H = h + Z$$

where	$h$	=	the pressure head
	$Z$	=	the gravitational head

The pressure head is numerically equal to the soil water tension or suction (Richards, 1965), but of opposite sign when the soil water tension is expressed in units of length of a column of water. The pressure head should not be interpreted as the actual pressure in the soil water, but as an equivalent pressure, that is, the pressure in a body of water which is in hydraulic equilibrium with the soil water. The body of water may be in a piezometer tube at its termination in the soil, or it may be the water inside a tensiometer cup.

## 10 References

- 10.1 Klute A (1965) *Laboratory Measurement of Hydraulic Conductivity of Saturated Soil*, in Black CA (ed) (1965) *Methods of Soil Analysis. Part 1 – Physical and mineralogical methods, including statistics of measurement and sampling*, Agronomy Series 9, American Society of Agronomy, Madison, Wisconsin.
- 10.2 Hutcheson WL (1958), *Moisture flow induced by thermal gradients within unsaturated soils*, Special Report 40, Highway Research Board, 113-133.
- 10.3 Richards LA (1965) *Physical Condition of Water in Soil*, in Black CA (ed) (1965) *Methods of Soil Analysis. Part 1 – Physical and mineralogical methods, including statistics of measurement and sampling*, Agronomy Series 9, American Society of Agronomy, Madison, Wisconsin.

**Figure 1 – Constant head system for hydraulic conductivity measurement**

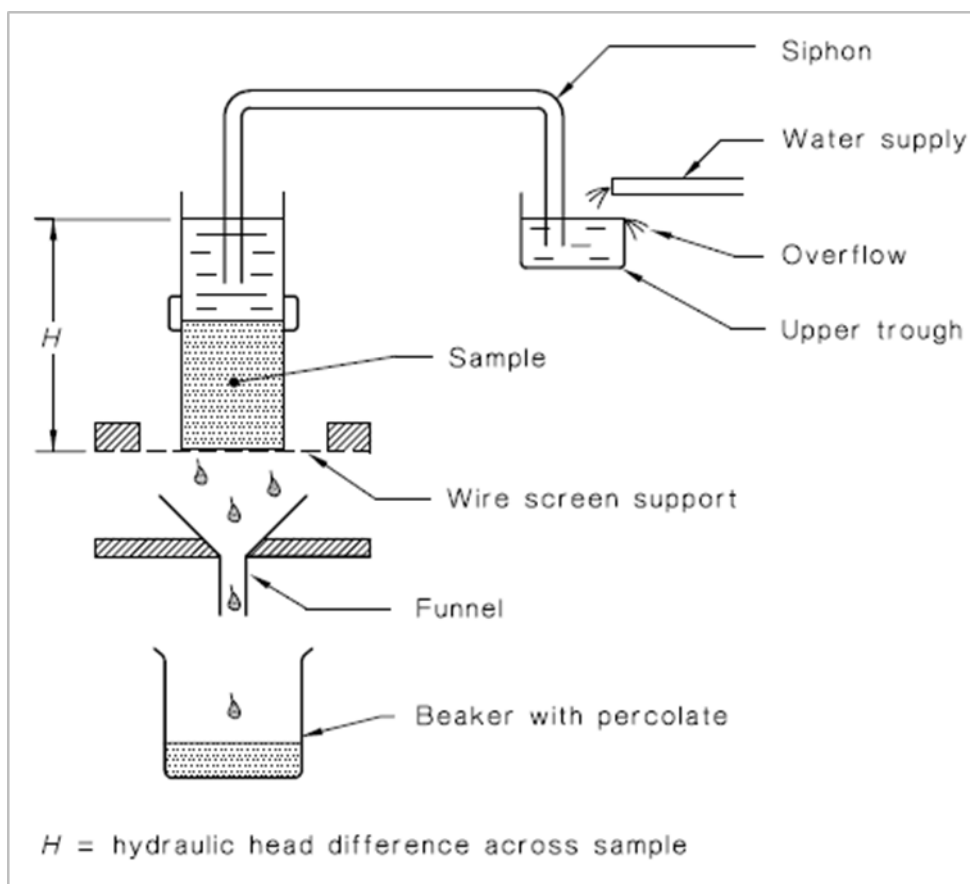

Source: AS 4419–2003 (superseded)

## Test Method Q165: Soil bulk density

### 1 Source

This Test Method was developed by laboratory managers for soil manufacturers and others who need a reproducible standard method, suitable for use in all soils, including gravelly soils.

### 2 Scope

This Test Method describes the procedure for determining the bulk density of a soil. Soil bulk density, also known as dry bulk density, is the weight of dry soil divided by the total soil volume.

### 3 Background

The total soil volume of a soil is the combined volume of solids and pores which may contain air or water. The average values of air, water and solid material in soil are easily measured and are a useful indication a soil's porosity.

Soil bulk density and porosity (the number of pore spaces) reflects the size, shape and arrangement of particles and voids (soil structure). Both bulk density and structure give a good indication of the suitability for root growth and soil permeability and are vitally important for the soil-plant-atmosphere system (Cresswell and Hamilton, 2002; McKenzie et al., 2004) (Note 8.1)

### 4 Apparatus

The following apparatus are required:

- 4.1 Drying oven, of suitable capacity, capable of heating a sample of soil to  $40 \pm 2^\circ\text{C}$ .
- 4.2 Balance of suitable capacity, having a resolution of at least 0.1 g and with a limit of performance within the range of  $\pm 0.5$  g.
- 4.3 Sieve or screen, 2 mm.
- 4.4 Tray, suitable size for drying soil.
- 4.5 Measuring cylinder, graduated plastic or glass cylinder of one L capacity.
- 4.6 Scoop.

### 5 Procedure

The procedure shall be as follows:

- 5.1 Place the test portion on a tray. Place the soils test portion and tray in the oven and dry to a constant mass (Note 8.2).
- 5.2 Remove soil test portion and tray from oven. Sieve the soil to pass 2 mm sieve.
- 5.3 Determine the mass of measuring cylinder ( $w_1$ ).
- 5.4 Using a scoop, carefully introduce the dry soil into the measuring cylinder to minimise any compaction. Fill the measuring cylinder to the 1000 mL mark and do not overfill.
- 5.5 Gently compact the soil by tapping the cylinder on the bench from a height of approximately 10 cm.
- 5.6 Record the volume of the soil in the measuring cylinder ( $V$ ).
- 5.7 Determine the mass of measuring cylinder and soil ( $w_2$ ).

## 6 Calculations

The calculation shall be as follows:

$$BD = \frac{w_2 - w_1}{V}$$

- where
- |       |   |  |
|-------|---|--|
| $BD$  | = | bulk density (kg/L) (Notes 8.3, 8.4 and 8.5) |
| $w_2$ | = | mass of measuring cylinder and soil (g)      |
| $w_1$ | = | mass of measuring cylinder (g)               |
| $V$   | = | volume of compacted soil (mL)                |

## 7 Reporting

The following shall be reported:

- 7.1 Bulk density to the nearest 0.01 kg/L.
- 7.2 The number of this Test Method, that is Q165.

## 8 Notes on method

- 8.1 For further information and forms for recording test data, refer to Department of Transport and Main Roads, *Soil Management Manual*. Specifically, Section 8.6 and Appendix 2 *Soil Testing Forms*.
- 8.2 Constant mass is achieved when, after the initial drying period, successive drying over one-hour periods gives rise to a weight loss of not more than 1% of the initial weight loss.
- 8.3 Bulk density (kg/L or g/cm<sup>3</sup>) = dry soil weight (kg or g) / soil volume (L or cm<sup>3</sup>).
- 8.4 Bulk density is often expressed in milligrams per cubic metre (mg/m<sup>3</sup>) but the numerically equivalent units of g/cm<sup>3</sup> and t/m<sup>3</sup> are also used.
- 8.5 1 mg/m<sup>3</sup> = 1 g/cm<sup>3</sup> = 1 t/m<sup>3</sup> (Cresswell and Hamilton, 2002).

## 9 References

- 9.1 Cresswell HP Hamilton (2002) Particle Size Analysis. In: *Soil Physical Measurement and Interpretation For Land Evaluation*. (Eds. NJ McKenzie, HP Cresswell and KJ Coughlan) CSIRO Publishing, Collingwood, Victoria. 224-239
- 9.2 McKenzie NJ Jacquier DJ Isbell RF Brown KL (2004) *Australian Soils and Landscapes: An Illustrated Compendium*, CSIRO Publishing, Collingwood, Victoria.

**Figure 1 – Structural composition of soil, containing soil fraction ( $V_{solids}$ ) and pore space for air ( $V_{air}$ ) and water ( $V_{water}$ )**

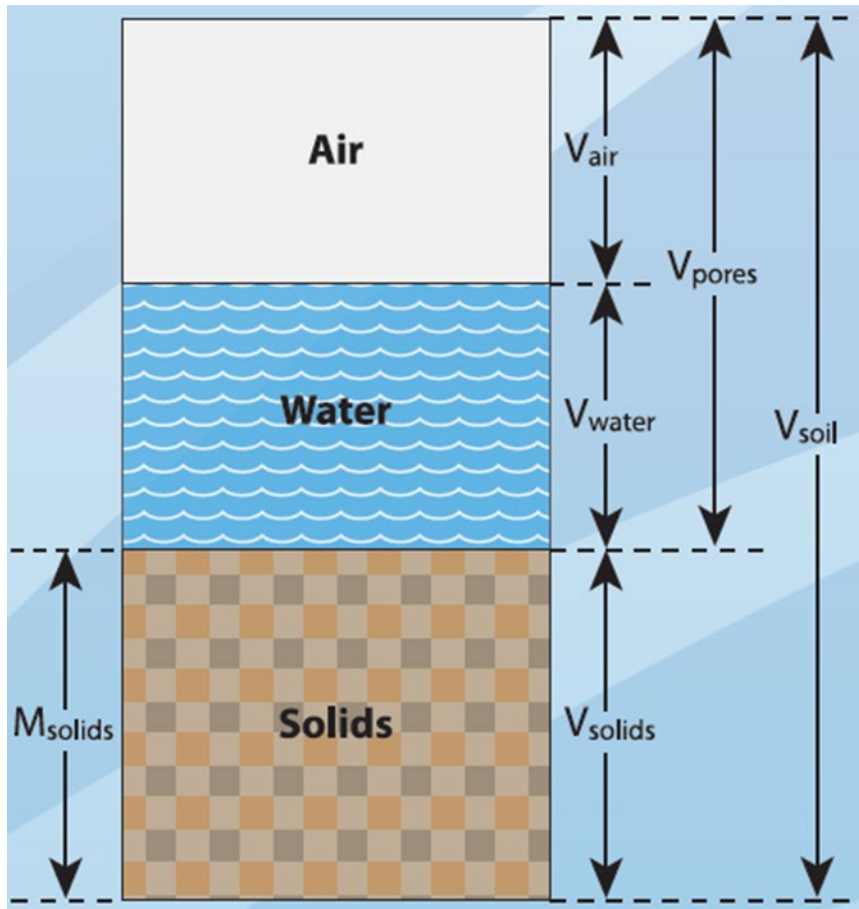

Source: <http://www.soilquality.org.au/factsheets/bulk-density-on-farm-use>



## Test Method Q166: Soil field texture

### 1 Source

This Test Method has been adapted from MacDonald RC, and Isbell RF (2009) *Australian Soil and Land Survey Field Handbook* 3<sup>rd</sup> edn, CSIRO Publishing: 161-169.

### 2 Scope

This Test Method describes the procedure for determining soil field texture. Soil field texturing, also known as soil hand texturing, is determined by qualitatively measuring, by feel and observation, the behaviour of a hand-held sample of moistened soil (Note 8.1).

### 3 Background

In Australia, a soil texture class is determined by the field (hand) texturing method as opposed to the USA, which generally uses the particle size analysis method – refer to Test Method Q167 *Soil particle size analysis (PSA)*.

There is only an approximate relationship between field texture and PSA, as factors other than clay, silt and sand content influence field texture (McDonald et al., 1998). Therefore, PSA percentages must not be used to determine a field texture.

The field texture of a soil is described as a field texture class or field texture grade. The department uses the term '*field texture class*' and groups the classes into the following categories:

- a) sand to clayey sand
- b) sandy loam – to silty clay loam
- c) light clay – to heavy clay.

### 4 Apparatus

The following apparatus are required:

- 4.1 Sieve or screen, 2 mm.
- 4.2 Steel rule.

### 5 Materials

The following material is required:

- 5.1 Deionised or distilled water (low EC rainwater suitable EC, 0.01 dS/m).

### 6 Procedure

The procedure shall be as follows:

- 6.1 Screen soil sample using a 2 mm sieve
- 6.2 Take a sample of the screened soil, sufficient to fit comfortably into the palm of the hand
- 6.3 Moisten the soil with a small amount of water at a time, to achieve a bolus (ball) of soil that just fails to stick to the fingers; the addition of more soil or water may be required to achieve this condition (the condition is known as the *sticky point*, which approximates *field* capacity for that soil) – refer to Figure 1 . Bolus is moistened and kneaded soil into a ball slightly larger than the size of a golf ball (Note 8.2).

- 6.4 Continue kneading and moistening the soil, without the further addition of soil or water, for approximately one–two minutes, until there is no apparent change in the bolus.
- 6.5 Press the bolus out horizontally between thumb and forefinger allowing it to break on its own (do not shear the ribbon) – refer to Figure 1(b).
- 6.6 Observe and feel the behaviour of the:
  - a) bolus during formation, and
  - b) ribbon during pressing.
- 6.7 Measure the length of the ribbon after breaking.
- 6.8 Refer to Table 1 to determine the texture class.

**Figure 1 – Soil bolus (ball) and ribbon formation**



(a) Soil ball almost at sticky point.



(b) Soil ball being ribboned.

## 7 Reporting

The following shall be reported:

- 7.1 Soil field texture class.
- 7.2 The number of this Test Method, that is Q166.

## 8 Notes on method

- 8.1 For further information and forms for recording test data, refer to Department of Transport and Main Roads, *Soil Management Manual*. Specifically, Section 8.5 and Appendix 2 *Soil Testing Forms*.
- 8.2 Soil properties affecting determination of field texture grade are as follows:
  - a) Clay (particles less than 0.002 mm in diameter) results in cohesion, stickiness and plasticity to the bolus and increases its resistance to deformation.
  - b) The type of clay mineral influences the tractability of the bolus. Montmorillonite clays tend to make the bolus resist deformation and therefore it can be stiff to ribbon. Thus, a long ribbon may suggest a finer (more clayey) field texture than the percentage clay content would indicate. By contrast, kaolinite clays make the field texture appear less clayey than the percentage clay content would indicate, as they tend to produce a short thin ribbon from the bolus.

- c) Silt (particles 0.002 mm–0.02 mm in diameter) often confers a silky smoothness on field textures, as it fills in the particle size range between sand (particles > 0.02 mm in diameter) and clay.
- d) Organic matter confers cohesion to sandy field textures and a greasiness to clayey field textures; it tends to produce a short thick ribbon from the bolus. Some soils containing about 40%–50% clay-sized particles and sufficient organic matter (> 20%) will behave as clay loams and light clays instead of medium or heavy clays. Large amounts of organic matter in dry soils may resist wetting and make bolus preparation difficult.
- e) When present in significant amounts, oxides – chiefly those of iron and aluminium – may require extra water for the soil to form the bolus. This may shear readily to produce a short ribbon, indicating a less clayey field texture than the clay content suggests. Such soil materials are sub-plastic.
- f) Calcium and magnesium carbonates in the fine earth fraction (particles < 2 mm in diameter) will usually impart a porridge-like consistency to the bolus. They tend to increase the apparent clay content of sandy and loamy field textures such that amounts of 10%–30% calcium carbonate cause the field texture to increase about one grade above that obtained when the carbonates are removed from the fine earth fraction. Carbonates may also make clay field textures appear less clayey by shortening the ribbon produced from the bolus.
- g) Cation composition: in general, calcium-dominant clays accept water readily and are easy to knead and smooth to field texture. Sodium-dominant and magnesium-dominant clays, however, are often difficult to wet and knead, producing a slimy, tough bolus, resistant to shearing and often appearing to have a more clayey field texture than would be indicated by the actual clay content.
- h) Strong, fine-structural aggregation will tend to cause an underestimation of clay content, due to the incomplete breakdown of the structural units during bolus preparation. Longer and more vigorous kneading is necessary to produce a homogeneous bolus.
- i) The above properties occur in soils to differing degrees and specific allowance cannot be made for them. Field texture must remain a subjective but reproducible measure of the behaviour of a handful of soil moistened and kneaded into an adequately prepared bolus and subjected to shearing manipulation between thumb and forefinger. However, this method provides a very useful assessment of the physical behaviour of soil in the field.
- j) Refer to the relevant *soil test parameter* and the related *test result* in the *Soil Management Manual / Technical Specification MRTS16 Landscape and Revegetation Works* soil testing form to determine these properties, for example – refer to the CCR value of the relevant *Soil Management Manual / MRTS16 Landscape and Revegetation Works* soil testing form to determine the clay mineralogy (montmorillonite or kaolinite) of the soil sample.

## 9 References

- 9.1 MacDonald RC, and Isbell RF (2009) *Australian Soil and Land Survey Field Handbook*, 3rd edn, CSIRO Publishing:161–169
- 9.2 McDonald RC Isbell RF Speight JG Walker J Hopkins MS (1998) *Australian Soil and Land Survey Field Handbook*, Australian Collaborative Land Evaluation Program, Canberra.

**Table 1 – Behaviour of moist soil bolus**

Texture code	Texture class	Behaviour of moist bolus	Approx. clay content (%)
S	Sand	Coherence nil to very slight, cannot be moulded; sand grains of medium size; single sand grains adhere to fingers.	< 5
LS	Loamy sand	Slight coherence; sand grains of medium size; can be sheared between thumb and forefinger to give minimal ribbon of about 5 mm.	About 5
CS	Clayey sand	Slight coherence; sand grains of medium size; sticky when wet; many sand grains stick to fingers; will form minimal ribbon of 5 mm–15 mm; discolours fingers with clay stain.	5–10
SL	Sandy loam	Bolus coherent but very sandy to touch; will form ribbon of 15 mm–25 mm; dominant sand grains are of medium size and are readily visible.	10–20
L	Loam	Bolus coherent and rather spongy; smooth feel when manipulated but with no obvious sandiness or 'silkeness'; may be somewhat greasy to the touch if much organic matter present; will form ribbon of about 25 mm.	About 25
ZL	Silty loam	Coherent bolus; very smooth to often silky when manipulated; will form ribbon of about 25 mm.	About 25 With silt 25 or more
SCL	Sandy clay loam	Strongly coherent bolus, sandy to touch; medium-size sand grains visible in finer matrix; will form ribbon of 25 mm–40 mm.	20–30
CL	Clay loam	Coherent plastic bolus, smooth to manipulate; will form ribbon of 40 mm–50 mm.	30–35
CLS	Clay loam, sandy	Coherent plastic bolus; medium-size sand grains visible in finer matrix; will form ribbon of 40 mm–50 mm.	30–35
ZCL	Silty clay loam	Coherent smooth bolus, plastic and often silky to the touch; will form ribbon of 40–50 mm.	30–35 With silt 25 or more
LC	Light clay	Plastic bolus; smooth to touch; slight resistance to shearing between thumb and forefinger; will form ribbon of 50 mm–75 mm	35–40
LMC	Light medium clay	Plastic bolus; smooth to touch; slight to moderate resistance to ribboning shear; will form ribbon of about 75 mm.	40–45

<b>Texture code</b>	<b>Texture class</b>	<b>Behaviour of moist bolus</b>	<b>Approx. clay content (%)</b>
MC	Medium clay	Smooth plastic bolus; handles like plasticine and can be moulded into rods without fracture; has moderate resistance to ribboning shear; will form ribbon of 75 mm or more.	45–55
MHC	Medium, heavy clay	Smooth plastic bolus; handles like plasticine; can be moulded into rods without fracture; has moderate to firm resistance to ribboning shear; will form ribbon of 75 mm or more.	50 or more
HC	Heavy clay	Smooth plastic bolus; handles like stiff plasticine; can be moulded into rods without fracture; has firm resistance to ribboning shear; will form ribbon of 75 mm or more.	50 or more

## Test Method Q167: Soil particle size analysis (PSA)

### 1 Source

This Test Method has been adapted from the Department of Sustainable Natural Resources (n.d.) *Soil Survey Standard Test Method – Particle Size Analysis* (P7 B 3), Department of Sustainable Natural Resources, New South Wales.

### 2 Scope

This Test Method describes the procedure for undertaking particle size analysis on mineral soil particles ( $\leq 2.00$  mm in diameter) to determine the particle size distribution of sand, silt and clay particles.

### 3 Background

Soil consists of primary soil particles – sand, silt and clay. The object of a particle size analysis is to group these particles into separate ranges of sizes and so determine the relative proportion (percentage) by mass of each size range (Table 1).

The method involves the sieving and sedimentation of a soil / water / dispersant suspension to separate the particles. The sedimentation technique is based on an application of Stokes' law to a soil / water suspension and periodic measurement of the density of the suspension (Note 10.1).

### 4 Apparatus

The following apparatus are required:

- 4.1 Soil hydrometer (ASTM 152H hydrometer preferred), graduated from -2 to +60, with graduation lines at every g/L.
- 4.2 Sedimentation cylinders, uniform set of cylinders with internal depth of  $340 \pm 20$  mm and capacity of 1 L (Note 10.2).
- 4.3 Sieves, 4.75 mm, 2.00 mm and 0.200 mm.
- 4.4 Timer.
- 4.5 Shaker, end-over-end shaker capable of holding the sedimentation cylinders and rotating at 15 rpm.
- 4.6 Balance, of suitable capacity, having a resolution of at least 0.01 g and with a limit of performance within the range  $\pm 0.05$  g.
- 4.7 Bottle with stopper.
- 4.8 Measuring cylinder, of 1000 mL, 250 mL, 100 mL and 50 mL capacity.
- 4.9 Plunger.
- 4.10 Drying oven of suitable capacity, having a temperature of  $105^{\circ}\text{C}$  –  $110^{\circ}\text{C}$  and conforms to AS 1289.0.
- 4.11 Thermometer, a partial or total immersion thermometer or other suitable temperature measuring device with a temperature range of at least  $0^{\circ}\text{C}$ – $50^{\circ}\text{C}$  and graduated to  $1^{\circ}\text{C}$  or less with an uncertainty of no more than  $0.5^{\circ}\text{C}$ .
- 4.12 Desiccator
- 4.13 Siphon or pipette.

- 4.14 Moisture tin with lid.
- 4.15 Steel rule.
- 4.16 Calliper.

The following apparatus may be used:

- 4.17 Crusher, either mini jaw crusher or mortar and pestle.

## 5 Materials

The following materials are required:

- 5.1 Deionised or distilled water.
- 5.2 Dispersing agent (Calgon, 25% sodium hexametaphosphate)
  - Prepare by dissolving 250 g of sodium hexametaphosphate (LR Grade) in 900 mL of warm deionised water. When cool add sufficient sodium carbonate to raise the pH to 8 or 9 and dilute to 1 L with deionised water.
  - This solution is unstable and is to be freshly prepared approximately once a month with the preparation and expiry dates recorded on the container.

## 6 Hydrometer calibration

The hydrometer shall be calibrated as follows:

- 6.1 The value of effective depth ( $L$ ) for each hydrometer (refer to Figure 1) and the sedimentation cylinder in which it is to be used is to be calculated as follows:
  - 6.1.1 The volume of the hydrometer bulb ( $V_b$ ) can be measured by the rise in level of water in a 250 mL measuring cylinder, initially filled to the 150 mL mark.
  - 6.1.2 For all readings, the hydrometer is placed in the suspension 20 seconds before each reading.

$$L = L_1 + 0.5 \left( \frac{L_2 - V_b}{A} \right)$$

- where
- $L$  = effective depth of hydrometer (mm)
  - $L_1$  = distance along the stem of the hydrometer from the top of the bulb to the mark for a hydrometer reading (mm)
  - $L_2$  = overall length of the hydrometer bulb (mm)
  - $V_b$  = volume of hydrometer bulb (cm<sup>3</sup>)
  - $A$  = cross-sectional area of sedimentation cylinder (cm<sup>2</sup>)

- 6.1.3 An effective depth ( $L$ ) should be worked out for each of the major calibration marks from 60 to -5 g/L on each hydrometer (Note 10.3).

## 7 Procedure

The procedure shall be as follows:

### 7.1 Sample preparation

- 7.1.1 Obtain an air-dried sample sufficient to obtain a sample passing the 2.00 mm sieve of about 50 g.

- 7.1.2 Pass the sample through a 4.75 mm and a 2.00 mm sieve making sure that no aggregations are retained on the sieve.
- 7.1.3 Alternatively, the sample may be passed through a mechanical crusher with apertures of 2.00 mm to obtain material < 2.0 mm.
- 7.1.4 Determine the mass retained on the 4.75 mm and 2.00 mm sieve ( $m_r$ ) to the nearest 0.01 g.
- 7.1.5 Obtain a second subsample of at least 30 g to determine the moisture content. Screen this material over a 2.0 mm sieve. Using the material passing the 2.00 mm sieve, determine the mass of moisture tin ( $m_r$ ), mass of tin and moisture subsample ( $m_2$ ). Place in 105°C–110°C oven and dry to constant mass. Remove tin from oven and cool in desiccator before determining the mass of tin and dry subsample ( $m_3$ ).
- 7.1.6 Using the material < 2.00 mm, determine the mass of the sample for hydrometer analysis ( $m_4$ ).

## **7.2 Sample pre-treatment (only if required)**

Where electrical conductivity (EC – 1:5 soil to water) > 1.0 dS/m and the clay flocculates in a 1:5 suspension, soluble salts are to be removed as follows:

- 7.2.1 Place the test portion of air-dry soil (< 2.0 mm) into a shaking bottle.
- 7.2.2 Half fill the bottle with hot tap water.
- 7.2.3 Shake for 10 minutes.
- 7.2.4 Allow the soil to settle until the supernatant is clear.
- 7.2.5 Siphon off the clear liquid.
- 7.2.6 Refill with deionised water and repeat Steps 7.2.3 to 7.2.5 up to a maximum of four times or until the clay begins to disperse or EC – 1:5 soil to water is < 0.3 dS/m.

## **7.3 Dispersion and shaking**

- 7.3.1 Where the sample has been pre-treated, add 200 mL of deionised water and 20 mL of 25% sodium hexametaphosphate.
- 7.3.2 Where the sample has not been pre-treated, place 50 g of air-dry soil (< 2 mm) into a shaking bottle and add 200 mL of deionised water and 20 mL of 25% sodium hexametaphosphate.
- 7.3.3 Place the bottles on an end-over-end shaker and shake for 16 hours (overnight) at 15 rpm.

## **7.4 Sedimentation**

- 7.4.1 On completion of shaking, transfer the prepared and dispersed sample to 1 L sedimentation cylinder (Note 10.2). Fill to the 1 L mark with deionised water. Record the hydrometer used.
- 7.4.2 Stir with a plunger for 20 seconds–30 seconds ensuring that all material at the bottom is brought into suspension. At the end of stirring, remove the plunger and immediately start the interval timer.
- 7.4.3 After four minutes' sedimentation, immerse the hydrometer to a depth slightly below its floating position and allow it to float freely. Take a reading at five minutes ( $H$ ). Read at the top of the meniscus and record readings to the nearest 0.5 g/L.
- 7.4.4 Remove the hydrometer slowly, rinse clean and place in a sedimentation cylinder filled with deionised water and 20 mL of 25% sodium hexametaphosphate (blank solution). The water temperature in the blank cylinder must be the same as that of the soil suspension.



- 7.4.5 Re-insert the hydrometer in the soil suspension for readings ( $H$ ) at periods of 30, 93 and 420 minutes, taken in the same manner as above. If it is not possible to take a 420-minute reading, take a substitute reading at the end of the day, noting the elapsed time.
- 7.4.6 At about the same time as each soil suspension hydrometer reading, take a hydrometer ( $B$ ) and temperature reading (to the nearest  $0.5^{\circ}\text{C}$ ) of the blank solution. Read the hydrometer at the top of the meniscus. The hydrometer should be left in the blank solution between readings.

## 7.5 Sand measurement

- 7.5.1 Pass the contents of the cylinder through the 0.200 mm sieve and thoroughly wash free of all fine particles; those particles retained on the sieve are the coarse sand fraction.
- 7.5.2 Transfer the sand from the sieve into a pre-weighed, numbered weighing tin.
- 7.5.3 Place in a drying oven between  $105^{\circ}\text{C}$  and  $110^{\circ}\text{C}$  and dry to a constant mass.
- 7.5.4 When dry, cool in a desiccator.
- 7.5.5 Determine the mass retained on the 0.200 mm sieve ( $m_r$ ) to the nearest 0.01 g.

## 8 Calculations

The calculations shall be as follows:

### 8.1 Sample masses

- 8.2 Calculate the moisture content of material  $< 2.00$  mm as follows:

$$w = \frac{m_2 - m_3}{m_3 - m_1} 100$$

- where
- $W$  = moisture content of material  $< 2.00$  mm (%)
  - $m_2$  = mass of moisture tin + wet soil (g)
  - $m_3$  = mass of moisture tin + dry soil (g)
  - $m_1$  = mass of moisture tin (g)

- 8.3 Calculate the dry mass of material  $< 2.00$  mm as follows:

$$m_s = \frac{100m_4}{100 + w}$$

- where
- $m_s$  = dry mass of test portion  $< 2.00$  mm (g)
  - $m_4$  = mass of sample for hydrometer analysis (g)
  - $W$  = moisture content of material  $< 2.00$  mm (%)

## 8.4 Sieving

8.4.1 Calculate the cumulative mass retained on each sieve (4.75 mm, 2.00 mm and 0.200 mm) as follows:

$$M_r = \sum m_r$$

where  $M_r$  = cumulative mass retained on a sieve (g)

$m_r$  = individual mass retained on each sieve (g)

8.4.2 Calculate the cumulative percent retained on each sieve (4.75 mm, 2.00 mm and 0.200 mm) as follows:

$$P_r = \frac{100M_r}{M_r + m_5}$$

where  $P_r$  = cumulative percent retained on a sieve

$M_r$  = cumulative mass retained on a sieve (g)

$m_5$  = dry mass of test portion < 2.00 mm (g)

8.4.3 Calculate the percent passing each sieve (4.75, 2.00 and 0.200 mm) as follows:

$$P_p = 100 - P_r$$

where  $P_p$  = percent passing a sieve

$P_r$  = cumulative percent retained on the sieve

## 8.5 Hydrometer

8.5.1 Calculate the percent by mass of particles finer than the corresponding particle diameter as follows:

$$P_D = \frac{100(H - B)}{m_5}$$

where  $P_D$  = percent by mass of particles finer than the corresponding particle diameter (%)

$H$  = hydrometer reading in soil suspension (g/L)

$B$  = hydrometer reading in blank solution (g/L)

$m_5$  = dry mass of test portion < 2.00 mm (g)

8.5.2 Calculate the particle size as follows:

$$D = 0.315K \sqrt{\frac{L}{t}}$$

where  $D$  = particle size (mm)

$K$  = sedimentation constant, which varies with temperature and particle density (refer to Table 2)

$L$  = effective depth of hydrometer (mm)

$t$  = elapsed time (mins)

8.5.3 If the particle density of the soil is known, use that value in Table 2), otherwise, use a value of 2.65 Mg/m<sup>3</sup>.

8.5.4 Plot the cumulative percentage ( $P$ ) versus sieve size / particle size diameter ( $D$ ) on a semi-logarithmic graph. Interpolate from the curve the percent of particles finer than 0.020 mm ( $P_{0.020}$ ) and 0.002 mm ( $P_{0.002}$ ) (Note 10.4).

## 8.6 Fraction sizes

8.6.1 Calculate the gravel fraction size as follows:

$$P_G = 100 - P_{2.00}$$

where  $P_G$  = gravel fraction size (percent gravel) (%)

$P_{2.00}$  = percent passing a sieve (2.00 mm)

8.6.2 Calculate the sand fraction size as follows:

$$P_S = P_{2.00} - P_{0.020}$$

where  $P_S$  = sand fraction size (percent sand) (%)

$P_{2.00}$  = percent passing a sieve (2.00 mm)

$P_{0.020}$  = percent passing a sieve (0.020 mm) (from hydrometer)

8.6.3 Calculate the coarse sand fraction size as follows:

$$P_{SC} = P_{2.00} - P_{0.200}$$

where  $P_{SC}$  = coarse sand fraction size (percent coarse sand) (%)

$P_{2.00}$  = percent passing a sieve (2.00 mm)

$P_{0.020}$  = percent passing a sieve (0.200 mm)

8.6.4 Calculate the fine sand fraction size as follows:

$$P_{SF} = P_S - P_{SC}$$

where  $P_{SF}$  = coarse sand fraction size (percent coarse sand) (%)

$P_S$  = sand fraction size (percent sand) (%)

$P_{SC}$  = coarse sand fraction size (percent coarse sand) (%)

8.6.5 Calculate the silt fraction size as follows:

$$P_M = P_{0.020} - P_{0.002}$$

where  $P_M$  = silt fraction size (percent silt) (%)

$P_{0.020}$  = percent passing a sieve (0.020 mm) (from hydrometer)

$P_{0.002}$  = percent passing a sieve (0.002 mm) (from hydrometer)

8.6.6 Calculate the clay fraction size as the percent passing the 0.002 mm size ( $P_{0.002}$ ) from the hydrometer.

## 9 Reporting

The following shall be reported:

- 9.1 Percent passing each sieve / particle size to the nearest 1%
- 9.2 Plot of the cumulative percentage ( $P$ ) versus sieve size / particle size diameter ( $D$ ) on a semi-logarithmic graph, if required.
- 9.3 Percent of each soil fraction in the sample, gravel, sand, coarse sand, fine sand, silt and clay (Note 10.5).
- 9.4 The number of this Test Method, that is Q167.

## 10 Notes on method

- 10.1 For further information and forms for recording test data, refer to Department of Transport and Main Roads, *Soil Management Manual*. Specifically, Section 8.5.1 and Appendix 2 *Soil Testing Forms*.
- 10.2 A group of 1 L measuring cylinders needs to be as uniform as possible. A diameter of approximately 60 mm (giving a cross-sectional area of approximately 30 cm<sup>2</sup>) and internal depth to the 1 L mark of 340 ± 20 mm are recommended. However, any uniform group of cylinders can be used provided they fall within ± 20 mm of the calibration table used.
- 10.3 A table, graph or equation should then be worked out for each hydrometer and its sedimentation cylinder. The relationship accounts for the effective depth of the suspension at the level being considered at a given time and allows for the rise of the liquid in the cylinder due to the displacement by the hydrometer.
- 10.4 The same graph may also be used to derive the 'very fine sand fraction' (0.02 mm–0.1 mm) for calculation of the Universal Soil Loss Equation (USLE).
- 10.5 Sand fraction is the combined as coarse and fine fraction 0.020 mm to 2.00 mm

**Table 1 – Particle size definitions**

Fraction	Components	Subdivision	Size (mm)
Coarse grained soil	Gravel		> 2.00
	Sand	Coarse	0.200–2.00
		Fine	0.020–0.200
Fine grained soil	Silt		0.002–0.020
	Clay		<0.002

**Table 2– Values of K for calculating the diameter of particles in hydrometer analysis**

Temperature (°C)	Density of soil particles (Mg/m <sup>3</sup> )					
	2.50	2.55	2.60	2.65	2.70	2.75
10	0.01633	0.01606	0.01681	0.01557	0.01534	0.01512
11	0.01610	0.01584	0.01559	0.01535	0.01512	0.01491
12	0.01588	0.01562	0.01537	0.01514	0.01491	0.01470
13	0.01566	0.01540	0.01516	0.01493	0.01471	0.01450
14	0.01545	0.01520	0.01496	0.01473	0.01451	0.01330
15	0.01525	0.01500	0.01476	0.01454	0.01432	0.01312
16	0.01505	0.01481	0.01457	0.01435	0.01414	0.01394
17	0.01486	0.01462	0.01439	0.01417	0.01396	0.01376
18	0.01467	0.01443	0.01421	0.01399	0.01378	0.01359
19	0.01449	0.01425	0.01403	0.01382	0.01361	0.01342
20	0.01431	0.01408	0.01386	0.01365	0.01344	0.01325
21	0.01414	0.01391	0.01369	0.01348	0.01328	0.01309
22	0.01397	0.01374	0.01353	0.01332	0.01312	0.01294
23	0.01381	0.01358	0.01337	0.01317	0.01297	0.01279
24	0.01365	0.01342	0.01321	0.01301	0.01282	0.01264
25	0.01349	0.01327	0.01306	0.01286	0.01267	0.01249
26	0.01334	0.01212	0.01291	0.01272	0.01253	0.01235
27	0.01319	0.01297	0.01277	0.01258	0.01239	0.01221
28	0.01304	0.01283	0.01264	0.01244	0.01225	0.01208
29	0.01290	0.01269	0.01249	0.01230	0.01212	0.01195
30	0.01276	0.01256	0.01236	0.01217	0.01199	0.01182

Source: Soil Survey Standard Test Method – Particle Size Analysis (P7 B 3), NSW DSNR

Figure 1 – ASTM 152H hydrometer dimensions for calculating effective depth

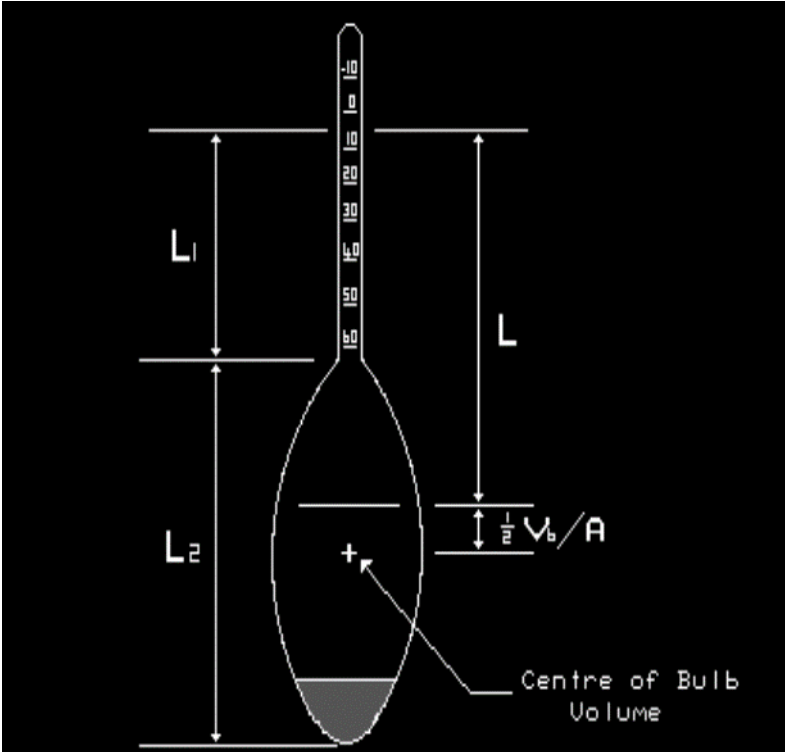

Source: Soil Survey Standard Test Method – Particle Size Analysis (P7 B 3), NSW DSNR

## Test Method Q168: Emerson class of a soil (modified)

### 1 Source

This method is based on Department of Sustainable Natural Resources (n.d.) *Soil Survey Standard Test Method P9 – Emerson Aggregate Test*, Department of Sustainable Natural Resources, New South Wales and AS 1289.3.8.1: *Soil classification tests – Dispersion – Determination of Emerson class number of a soil* except as follows:

- a) material is not sieved during preparation
- b) material is air-dried during preparation
- c) petri dishes or 250 mL beakers may be used
- d) dry soil aggregates of 5–10 mm diameter used at the start of the test, and
- e) a description of the Emerson class is also reported.

For further information refer to additional sources (Emerson 1967 and Emerson 2002).

### 2 Scope

This Test Method describes the procedure for determining the Emerson class number of a soil. Soils are divided into seven classes based on their coherence in water, with one additional class being distinguished by the presence of calcium-rich minerals.

The test classifies the behaviour of soil aggregates (that is, structure formed from a mass of fragments or particles loosely compacted together), when immersed in water. Sands and gravels are unsuitable for the test.

### 3 Background

Soil dispersion is a natural process determined by inherent properties such as clay content, clay type (mineralogy) and a range of soil chemical factors (salinity, ionic composition, pH, organic carbon). Dispersion can be promoted by the inputs of energy (including rainfall impact and disturbance by earthworks machinery).

In the context of the department, chemically-caused dispersion is what is meant by the term *dispersion*. It is considered a high-risk soil property and, as such, is tested for using this method (and other associated Test Methods). Note that soils with a high silt (0.002 to 0.02 mm) fraction can behave in a very similar manner to chemically-dispersive materials.

A high concentration of exchangeable sodium in soil is one of the key causes of dispersion, but not the only cause. The amount of exchangeable sodium is expressed via *ESP – Exchangeable Sodium Percentage* and soils with a high proportion of sodium are referred to as *sodic*. Not all sodic soils disperse and not all dispersive soils are sodic. Sodicity is a statement of the ionic composition of the soil, dispersion is a behavioural property.

Dispersion involves both chemical and physical processes in the soil and occurs when the soil is wet. Dispersion causes soil aggregations to break down, due to the separation of clay particles, resulting in the clogging of soil pores by the dispersed clay particles. The dispersed and suspended particles are seen as *milky* water in drains, basins and puddles (Note 9.1).

## 4 Apparatus

The following apparatus is required:

- 4.1 For determination of Emerson class number:
  - 4.1.1 Clear petri dish, at least 150 mm diameter and 30 mm deep. This allows sufficient depth of water and sufficient space for soil aggregates. A 250 mL beaker may be used as an alternative.
  - 4.1.2 Spatulas.
  - 4.1.3 Trays, for assessing and air-drying samples.
  - 4.1.4 Mixing bowl.
  - 4.1.5 Test tubes with stoppers and stand.
  - 4.1.6 Wash bottle.
  - 4.1.7 Black background.
  - 4.1.8 Timer.
- 4.2 For testing for the presence of calcite and gypsum:
  - 4.2.1 Volumetric flasks, of 100 mL capacity.
  - 4.2.2 Beakers, of 400 mL capacity.
  - 4.2.3 Beakers, of 250 mL capacity.
  - 4.2.4 Droppers or pipettes.
  - 4.2.5 Test sieve, 0.425 mm conforming to ISO 3310.
  - 4.2.6 Mortar and pestle.
  - 4.2.7 Stirring rod.
  - 4.2.8 Filter funnel and stand.
  - 4.2.9 Test tubes with stoppers and stand

## 5 Reagents

The following reagents are required (Note 9.2 and 9.3):

- 5.1 Hydrochloric acid 1M solution.
  - Prepare by diluting 89 mL of concentrated hydrochloric acid with distilled water to make 1 L of solution.
- 5.2 Barium chloride solution.
  - Prepare by dissolving 5 g of barium chloride in 100 mL of distilled water.
- 5.3 All reagents are laboratory reagent (LR) grade.

## 6 Materials

The following materials are required:

- 6.1 Water, deionised or distilled (Note 9.4).
- 6.2 Filter papers (Whatman No. 50 or similar grade) to fit the filter funnel.



## 7 Procedure

A summary of the procedure for determining the Emerson class number of a soil is shown in Table 1.

The procedure shall be as follows:

### 7.1 Preparation

- 7.1.1 Assess the sample provided to determine if it contains large aggregations of fines or clods. Spread the sample out on a tray and select at least aggregates of soil suitable for testing. If necessary, break up clods to produce aggregates using spatula. Do not touch the aggregates with bare hands. If required, air dry the selected soil aggregates.
- 7.1.2 From the air-dry aggregates, obtain the following:
- about 50 g of air-dried soil sufficient to obtain at least three air-dried soil aggregates of 5-10 mm diameter for Sub-section 7.2
  - about 20 g to 50 g of air-dried soil for Sub-section 7.3 as follows:
  - about 25 g of air-dried soil aggregates for checking for the presence of calcite in Sub-section 7.4
  - about 5 g of air-dried soil passing a 0.425 mm test sieve for checking for the presence of gypsum in Sub-section 7.4, and
  - about 2 g of air-dried soil aggregates for Sub-section 7.5.

### 7.2 Slaking and dispersion of dry soil

- 7.2.1 Fill a petri dish with deionised or distilled water, deep enough to cover the three soil aggregates, from Step 7.1.2 a).
- 7.2.2 Carefully place the three aggregates into the water so they are spaced apart.
- 7.2.3 Do not knock, disturb or place the petri dish in a windy position.
- 7.2.4 Observe each of the soil aggregates behaviour immediately, within five minutes and at two hours as follows:
- Observe whether instantaneous slaking occurs. If after two hours, no slaking occurs, observe the aggregates to determine if swelling has occurred (Note 9.5). Most dry soil aggregates will slake, that is, break up. The degree of slaking that may vary from slight edge breakdown (aggregates mostly intact), collapse into angular pieces (aggregate cone shaped), collapse into finer < 2 mm pieces (aggregate slightly evident) and finally complete breakdown into micro-aggregates (aggregate not evident) (Note 9.6).
  - If no aggregates slake and swelling does not occur to any aggregate, classify the soil as Class 8.
  - If no aggregates slake and at least one aggregate swells, classify the soil as Class 7.

- d) If any aggregate slakes and there is complete dispersion of an aggregate, classify the soil as Class 1. This is indicated by complete dispersion into individual particles (aggregate not evident) with a colloidal cloud covering the bottom of the dish or the entire dish becoming cloudy (Note 9.7).
- e) If any aggregate slakes and there is some dispersion of an aggregate, classify the soil as Class 2. This is indicated by a degree of dispersion that may vary from slight edge clouding (aggregate mostly intact), moderate clouding (aggregate slightly less evident) to considerable clouding (aggregate approximately 50% evident) (Note 9.7).

### **7.3 Dispersion of remoulded soil**

- 7.3.1 If the soil does not disperse after 120 minutes obtain 20–50 g of soil, from Step 7.1.2 b), and place in a mixing bowl. Add sufficient deionised or distilled water to bring the soil to a moisture content in the plastic range. Mix for 30 seconds to form a paste (Note 9.8).
- 7.3.2 Using a spatula, remould this material in a glass plate by forming a cube, flattening the cube, then remoulding the soil by folding back into a cube. Using a second spatula may make this process easier. Continue this flattening, folding and remoulding for two minutes.
- 7.3.3 Using the spatula, remould the material into three 5–10 mm diameter balls.
- 7.3.4 Fill a petri dish with deionised or distilled water, deep enough to cover the three soil aggregates.
- 7.3.5 Carefully place the three balls into the deionised or distilled water so they are spaced apart.
- 7.3.6 Do not knock, disturb or place the petri dish in a windy position.
- 7.3.7 If, after two hours, any dispersion occurs in accordance with Steps 7.2.4d) or 7.2.4e), classify the soil as Class 3.

### **7.4 Calcite or gypsum**

If the soil still does not disperse, check for the presence of calcium carbonate (calcite) or calcium sulfate (gypsum) as follows (Note 9.9):

- 7.4.1 Place approximately 25 g air-dried soil aggregates, from Step 7.1.2c), of the soil into a glass beaker.
- 7.4.2 Carefully place a few drops of the hydrochloric acid onto each of the soil aggregates, using a dropper or pipette.
- 7.4.3 If the acid fizzes when it is placed on the soil, calcite is present: classify the soil as Class 4, and do not test for gypsum.
- 7.4.4 Place approximately 5 g of soil, from Step 7.1.2d), passing the 0.425 mm test sieve into a beaker, then add deionised or distilled water and stir for one minute.
- 7.4.5 Filter the soil water mixture over the filter paper placed in a funnel, collecting the filtrate in a beaker.
- 7.4.6 Transfer some of the filtrate to a test tube and add a few drops of the barium chloride solution, using a dropper or pipette.
- 7.4.7 If the filtrate turns milky, gypsum is present: classify the soil as Class 4.

### **7.5 Dispersion or flocculation of soil / water suspension**

If calcium carbonate (calcite) and calcium sulfate (gypsum) are absent, check for dispersion or flocculation as follows:

- 7.6 Prepare a 1:5 soil / water suspension by placing 2 g of air-dried soil aggregates, from Step 7.1.2e), in the bottom of a test tube. Add 10 mL of distilled water and shake vigorously for 10 minutes.
- 7.7 Place the test tube in a stand for 10 minutes.
- 7.8 If the suspension remains dispersed, classify the soil as Class 5.
- 7.9 If the suspension begins to flocculate within 10 minutes, that is, the soil has settled and the water (supernatant) is clear or becoming clear at the surface of the water, classify the soil as Class 6.

## **8 Reporting**

The following shall be reported:

- 8.1 The Emerson class number.
- 8.2 The Emerson class description (refer to Table 2).
- 8.3 Type of water used (distilled or deionised).
- 8.4 The number of this Test Method, that is Q168.

## **9 Notes on method**

- 9.1 For further information and forms for recording test data, refer to Department of Transport and Main Roads, *Soil Management Manual*, 2020: specifically, Sections 6.4.2, 8.4.2 and Appendix 2 *Soil Testing Forms*.
- 9.2 Before handling chemicals and preparing reagents, the operator should consult the relevant SDS.
- 9.3 Unless otherwise indicated, all reagents are to conform to the specifications of the Committee on Analytical Reagents of the American Chemical Society, where such specifications are available.
- 9.4 Dispersion only occurs in non-saline water or rainwater with an EC < 0.001 dS/m; hence the use of deionised or distilled water for testing for clouding.
- 9.5 Swelling of aggregates that do not slake will occur almost instantaneously.
- 9.6 Dry soil aggregates slake when immersed in water, owing to the stresses induced both by the compression of air as the negative pore pressure attracts water into the soil, and by swelling. The release of compressed air may cause particles to fly off the aggregate. Refer to Test Method Q161 Table 1 for examples of slaking.
- 9.7 Refer to Test Method Q162 Table 1 for visual examples of dispersion. Class 1 in this method corresponds with Rating 4 in Q162 Table 1. Class 2 in this method corresponds with Ratings 1 to 3 in Q162 Table 1.

- 9.8 For some soils there is a minimum initial moisture content at which they just start to show dispersion when immersed in water. The water content is between the maximum water uptake of a dry soil and that corresponding to a suspension. For materials used in construction, it is convenient to wet the material to a moisture content within the plastic range. The working of the material in Sub-section 7.3 simulates the working of the material during construction. At this moisture content, the bonds between the clay particles are loosened by the water layers and dispersion is easier. The action of wetting, mixing and compacting the soil tends to further break up the clay domains and establish a more random orientation with a predominance of edge-to-face contacts. Dispersion is easier from this condition than from the orientated face-to-face condition; therefore, the wetting, mixing and compaction is an important part of the test procedure. After the soil aggregates are selected and rolled into a ball with the spatula, immerse them in the water immediately to avoid a thixotropic regain of strength.
- 9.9 The clay present in the soil may still not be dispersive if there are minerals in the aggregates or balls that dissolve rapidly enough to maintain the ionic concentration above the flocculation concentration. As the soluble salts diffuse out of soils containing calcium, the percentage of exchangeable sodium on the yet-undispersed clay is gradually reduced by exchange of sodium ions for calcium ions derived the calcium-bearing minerals, usually calcium carbonate (calcite) or calcium sulfate (gypsum), present, and the soil becomes less and less dispersive; thus, it is necessary to determine whether calcium -rich minerals are present in soils that do not disperse from the moist state.

## 10 References

- 10.1 Emerson WW (1967) *A classification of soil aggregates based on their coherence in water*, Australian Journal of Soil Research 5(1):47–57
- 10.2 Emerson WW (2002) Emerson Dispersion Test in McKenzie N, Coughlan K, Cresswell H (eds), *Soil Physical Measurement and Interpretation for Land Evaluation*, CSIRO Publishing:190–199, Melbourne.

**Table 1 – Determination of Emerson class number of a soil**

Step	Action
<b>1</b>	<b>Immersion</b>
	Immerse 3 air-dried 5 mm to 10 mm diameter aggregates of a soil in distilled water in a petri dish.
	Slakes. Go to Step 2.
	No slaking. Swelling = Emerson Class 7.
	No slaking. No swelling = Emerson Class 8.
<b>2</b>	<b>Dispersion</b>
	Slakes. No dispersion. Go to Step 3.
	Slakes. Some dispersion = Emerson Class 2.
	Slakes. Complete dispersion = Emerson Class 1.
<b>3</b>	<b>Remoulding</b>
	Mix 20–50 g with water to plastic range, remould for two minutes and form into three balls 5 mm to 10 mm diameter. Immerse in distilled water in a petri dish.
	Slakes. No dispersion. Go to Step 4.

<b>Step</b>	<b>Action</b>
	Slakes. Dispersion = Emerson Class 3.
<b>4</b>	<b>Check for calcite and gypsum</b>
	Slakes. No dispersion. No calcite or gypsum present. Go to Step 5.
	Slakes. No dispersion. Calcite present = Emerson Class 4.
	Slakes. No dispersion. Gypsum present = Emerson Class 4.
<b>5</b>	<b>Suspension</b>
	Obtain air-dried soil aggregates. Make up 1:5 soil / distilled water suspension in a test tube and shake for 10 minutes.
	Slakes. Remains dispersed = Emerson Class 5.
	Slakes. Flocculates = Emerson Class 6.

**Table 2 – Emerson class description**

<b>Emerson class number</b>	<b>Emerson class description</b>
1	Slakes. Complete dispersion.
2	Slakes. Some dispersion.
3	Slakes. Dispersion after remoulding.
4	Slakes. No dispersion. Calcite present. or Slakes. No dispersion. Gypsum.
5	Slakes. Dispersion in soil/water suspension.
6	Slakes. Flocculation in soil/water suspension.
7	No slaking. No dispersion. Swelling.
8	No slaking. No dispersion. No swelling.

**Figure 1 – Determination of Emerson class number of a soil**

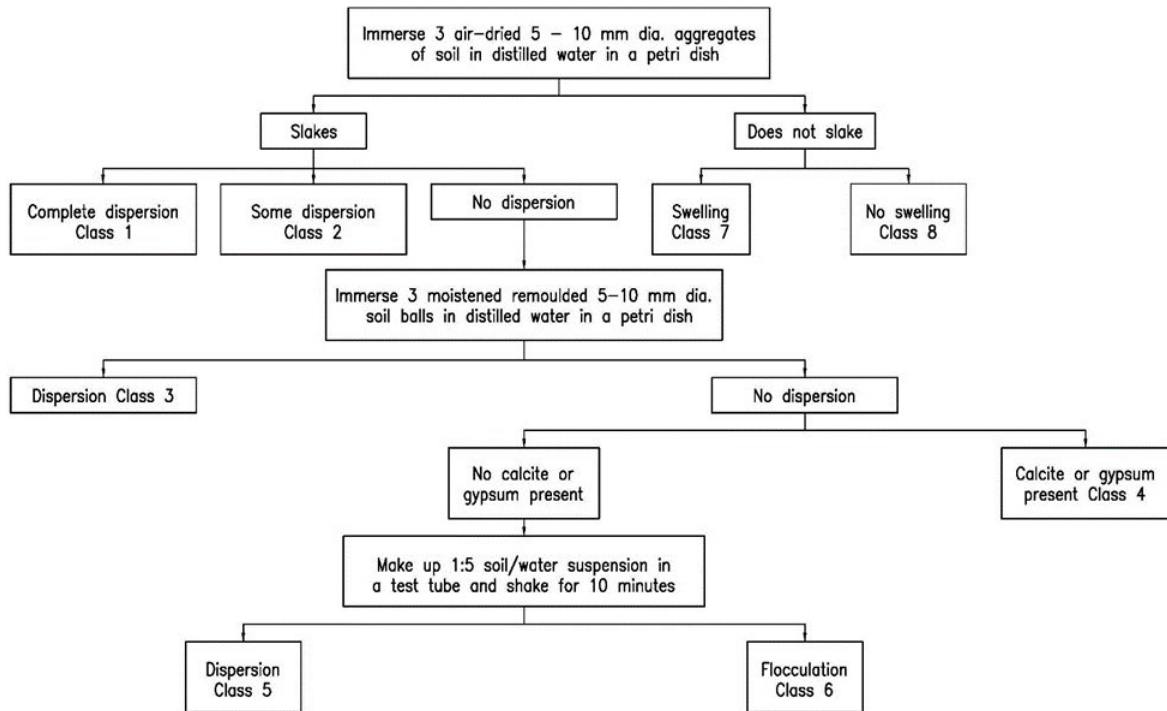

## Test Method Q181C: Effective angle of internal friction at constant volume conditions for granular materials – coarse grained

### 1 Source

This Test Method is based on ASTM D3080: *Standard Test Method for Direct Shear Test of Soils under Consolidated Drained Conditions*. It differs from this standard in the procedures for sample compaction, determination of failure criteria and the calculation and reporting of the test parameters. It also includes other minor procedural variations.

### 2 Scope

This Test Method describes the procedure for the determination of the effective angle of internal friction at constant volume conditions ( $\phi'_{cv}$ ) of a disturbed sample of backfill material used in reinforced soil structures when compacted into a shearbox in accordance with this Test Method. This method is applicable only to granular (coarse grained) materials, such as those used in reinforced soil structures, as these best exhibit constant volume conditions during shearing. It is used in Transport and Main Roads Technical Specification MRTS06 *Reinforced Soil Structures*.

The effective angle of friction is derived by linear regression and expressed as a line of best fit through the origin with a minimum of three individual tests at different values of normal stress.

The test is performed under the following conditions, unless otherwise specified:

- For materials tested using OMC/MDD:
  - standard compaction
  - nominated relative moisture content 100% of OMC, and
  - nominated relative compaction 97% MDD.
- For cohesionless materials:
  - cohesionless materials – nominated density index of 90%.

### 3 Apparatus

The following apparatus is required:

#### 3.1 Direct shear machine consisting of:

- a) base frame, motorised gear box unit, loading screw and 'frictionless' tracks
- b) shearbox assembly, with a minimum shearbox size of 300 mm square (Figure 1)
- c) force measuring device, capable of measuring the expected range of force applied to the specimen during shear conforming to the requirements of a Class B device in AS 2193
- d) two displacement measuring devices, capable of measuring the expected ranges of travel of the change in height of the specimen and the horizontal displacement during shear and conforming to the requirements of Table 1, and
- e) vertical loading system, consisting of either a load hanger with masses or a hydraulic loading system capable of applying the required loads to an accuracy of  $\pm 1\%$  of the required normal load. A system using masses should be checked on a regular schedule. Other systems of applying force such as a load cell and force indicator conforming to the requirements of a Class A device in AS 2193.

- 3.2 Compaction rammer, with approximately 50 mm square end to enable compaction of material into the corners of the shearbox.
- 3.3 Sieves, 19.0 mm and 9.50 mm conforming to ISO 3310.
- 3.4 Mixing apparatus, such as a tray, trowel or scoop.
- 3.5 Balance of suitable capacity, having a resolution of at least 0.1 g and with a limit of performance within the range of  $\pm 0.5$  g.
- 3.6 Timer, capable of measuring 15 second intervals with a resolution not exceeding 1 second.
- 3.7 Calliper, suitable for measuring the dimensions of the shearbox with a resolution not exceeding 0.1 mm and conforming to ISO 13385-1 or JIS B 7507.
- 3.8 Tool for scarifying each compacted layer, such as a trowel or spatula.

#### **4 Materials**

The following materials are required:

- 4.1 Grease.
- 4.2 De-mineralised water for filling shear-box carriage.

#### **5 Sample preparation**

The sample shall be prepared as follows:

- 5.1 Prepare the bulk sample in accordance with Section 4 of Test Method Q101 to produce a representative sample of appropriate size.
- 5.2 Further prepare the material by screening the sample on a 19.0 mm sieve in accordance with Test Method Q101, Steps 5.2.1 to 5.2.2 to provide a minimum of 120 kg of material. Ensure that any aggregations are broken up to pass a 9.50 mm sieve. Discard any material retained on the 19.0 mm sieve and thoroughly remix the material passing the 19.0 mm sieve.
- 5.3 Prepare representative test portions of the sieved material in accordance with Test Method Q101, Steps 5.2.3 to 5.2.5 as follows:
  - a) minimum of three shear test portions by the method of preparation indicated in Table 2. Ensure the test portions are of sufficient mass to fill the shearbox when compacted to the required target dry density (Note 10.1)
  - b) test portion for hygroscopic moisture content, and
  - c) test portions to determine target dry density and target moisture content in accordance with Table 2 as follows:
    - i. four or more test portions to determine MDD and OMC, or
    - ii. suitable number of test portions to determine maximum dry density and minimum dry density.
- 5.4 Determine the hygroscopic moisture content ( $w_1$ ) of the shear test portions in accordance with Test Method AS 1289.2.1.1.
- 5.5 Determine the mass of each shear test portion ( $m_1$ ).



- 5.6 Determine the target dry density and target moisture content in accordance with Table 2 as follows:
- a) determine the OMC and MDD of the test portion prepared in Step 5.4 b) in accordance with Test Method Q142A or Q142B as appropriate using a Type A mould and using the specified curing time for the material in Test Method Q255 Table 1, or
  - b) determine the maximum dry density and minimum dry density of the test portion prepared in Step 5.4 b) in accordance with Test Method AS 1289.5.5.1 and using the specified curing time for the material in Test Method Q255 Table 1.

## 6 Preparation of test specimens

The test specimens shall be prepared as follows:

- 6.1 Calculate the target moisture content ( $w_t$ ) and target dry density ( $\rho_t$ ) to achieve either:
- a) the nominated relative compaction and nominated relative moisture content in accordance with Test Method Q145A, or
  - b) the nominated density index in accordance with Test Method Q145A.
- 6.2 Calculate the dry mass of each test portion ( $m_2$ ) and mass of mixing water to be added ( $m_3$ ), then mix and cure each the test portion in accordance with Test Method Q255.
- 6.3 Determine the hygroscopic moisture content ( $w_t$ ) of the shear test portions in accordance with Test Method AS 1289.2.1.1. For the purpose calculating the wet mass of the specimen and the wet mass required for each layer the hygroscopic moisture content is also the target moisture content ( $w_t$ ).

## 7 Procedure

The procedure shall be as follows:

### 7.1 Selection and calibration of shearbox

The shearbox required for the test shall be of sufficient size to accommodate the test specimen as determined in Step 6.4. Measure the length and width of the shearbox to the nearest 0.1 mm and determine the net calibrated volume ( $V_c$ ) of the shearbox in accordance with Step 8.1.3.

### 7.2 Normal stresses

Select three separate normal stresses for the test, evenly spaced over the range 100 to 300 kPa. Calculate the required normal loads in accordance with Step 8.2.

### 7.3 Set-up of test specimen

- 7.3.1 Lightly grease the contact surfaces between the upper and lower sections of the shearbox and then secure the sections using the two locking screws. Place the assembly in the carriage. Insert the two parting screws into the designated holes in the top half of the shearbox until contact is made with the bottom half.
- 7.3.2 Place the perforated, metal, gridded baseplate in the bottom of the shearbox assembly and seat it firmly. The teeth of the gridded plate must be aligned perpendicular to the direction of travel.

- 7.3.3 Form each test specimen in the shearbox in three layers as follows:
- a) Determine the wet mass of the specimen and the wet mass required for each layer in accordance with Steps 8.3.1 and 8.3.2 respectively.
  - b) Measure the required wet mass for the first layer and place the wet soil evenly in the shearbox, taking care to avoid segregation of the larger gravel particles.
  - c) Tamp the layer to the required thickness using the square ended compaction rammer, ensuring uniform density throughout.
  - d) Scarify the top of the layer and repeat this process for the subsequent two layers, ensuring the compacted layer boundaries are positioned so they are not coincident with the shear plane defined by the shearbox halves (Note 10.2). Compaction of the final layer should also allow for the embedment of the upper gridded plate, the top of which should finish flush with the top of the shearbox.
- 7.3.4 Place the loading cap and ball on top of the upper gridded plate.
- 7.4 Consolidation of the test specimen**
- 7.4.1 Assemble the normal loading system such that it contacts the loading ball and cap transferring minimal load to the test specimen. When positioning the yoke hanger to contact the loading ball and cap, ensure it is level and that load is not transferred to the specimen prior to commencing consolidation.
- 7.4.2 Position a vertical displacement measurement device on top of the yoke hanger and align it with the vertical axis of the specimen. Adjust the measurement device so that it is near the upper end of its range of travel. At this point, set the device to a convenient value and record the measurement as the initial (zero) vertical displacement reading ( $r_i$ ) (Note 10.3).
- 7.4.3 Fill the carriage with demineralised water.
- 7.4.4 Transfer the normal load directly to the specimen. Monitor the vertical deformation of the specimen by reading the vertical displacement device at the following time intervals: 0.25, 0.5, 1, 2, 4, 9, 16, 36, 64, 100 and 121 minutes from commencement of loading. Take readings for a minimum of 2 hours or until primary consolidation is substantially complete.
- 7.4.5 Plot vertical displacement against the square root of time and determine  $t_{100}$  by:
- a) Approximating the initial part of the curve by a straight line and extrapolating this line back to  $t = 0$ . The corresponding displacement represents 0 per cent primary consolidation.
  - b) A second straight line is then drawn through this point so that the abscissa of the line is 1.15 times the abscissa of the straight line approximation of the initial part of the curve. The intersection of the new line with the displacement/square root of time curve corresponds to 90 per cent primary consolidation. The displacement at 100 per cent primary consolidation is one-ninth more than the difference in displacements between 0 and 90 per cent consolidation (Figure 2) (Note 10.4).
- 7.4.6 Calculate the time to failure (in minutes) in accordance with Step 8.5.1.
- 7.4.7 Calculate the rate of horizontal displacement in mm/minute in accordance with Step 8.5.3. The rate of displacement to be used during shearing is to be the lesser of this calculated value or 1 mm/minute.

## 7.5 Shearing of the test specimen

- 7.5.1 Advance the drive on the direct shear machine so that the upper half of the shearbox assembly contacts the load measuring device and apply a slight seating load. Set the load measuring device to zero.
- 7.5.2 Set the horizontal displacement device to the zero displacement position and record the initial horizontal displacement reading ( $l_i$ ).
- 7.5.3 Record the reading on the vertical displacement device as the initial (zero) reading immediately prior to shear ( $r_f$ ).
- 7.5.4 Select a rate of travel on the direct shear machine to produce the calculated rate of horizontal displacement.
- 7.5.5 Remove any locking screws from the shearbox prior to shear and slightly separate the two box halves to ensure there is no contact between them during shearing (Note 10.5).
- 7.5.6 Commence shearing. As a minimum, record readings of shear load, vertical and horizontal displacement for every 0.2% of horizontal strain, that is, every 0.5 mm for the 300 mm box. Plot both shear load ( $P$ ) and vertical displacement readings ( $r$ ) against horizontal displacement ( $l$ ). Continue to take readings until the vertical displacement and shear load become constant or a minimum horizontal displacement of 15% of the length of the shearbox is attained.
- 7.5.7 After completion of the test, remove the specimen from the shearbox and determine its moisture content ( $w_a$ ) in accordance with Test Method AS 1289.2.1.1.
- 7.5.8 Repeat Steps 7.3 to 7.5.7 for two other values of normal stress as selected in Step 5.2.

## 8 Calculations

Calculations shall be as follows:

### 8.1 Shearbox dimensions

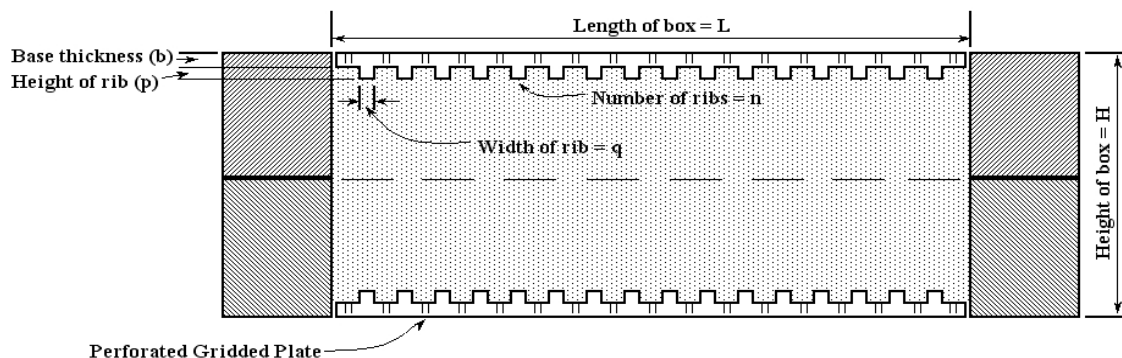

8.1.1 Calculate the mean thickness of each gridded plate as follows:

$$\bar{h}_p = b + \frac{npq}{L}$$

where  $\bar{h}_p$  = mean plate thickness (mm)  
 $b$  = thickness of base (mm)  
 $n$  = number of ribs  
 $p$  = height of rib (mm)  
 $q$  = width of rib (mm)  
 $L$  = length of shearbox (mm)

8.1.2 Calculate the net calibrated height of the shearbox as follows:

$$h_c = H - (\bar{h}_{p1} + \bar{h}_{p2})$$

where  $h_c$  = net calibrated height of shearbox (mm)  
 $H$  = total height of shearbox (mm)  
 $\bar{h}_{p1}$  = mean thickness of bottom gridded plate (mm)  
 $\bar{h}_{p2}$  = mean thickness of top gridded plate (mm)

8.1.3 Calculate the net calibrated volume and cross-sectional area of the shearbox as follows:

$$V_c = h_c A$$

where  $V_c$  = net calibrated volume of shearbox (mm<sup>3</sup>)  
 $h_c$  = net calibrated height of shearbox (mm)  
 $A$  = cross-sectional area of the shearbox (mm<sup>2</sup>)

$$A = LW$$

where  $A$  = cross-sectional area of the shearbox (mm<sup>2</sup>)  
 $L$  = length of shearbox (mm)  
 $W$  = width of shearbox (mm)

## 8.2 Applied normal load

Calculate the normal load to be applied for each normal stress as follows:

$$F_n = \frac{\sigma_n A}{10^{-6}}$$

where  $F_n$  = normal load (kN)  
 $\sigma_n$  = required normal stress (kPa)  
 $A$  = cross-sectional area of the shearbox (mm<sup>2</sup>)

## 8.3 Mass of test specimen

8.3.1 Determine the wet mass of each test specimen as follows:

$$m_w = \frac{\rho_t V_c (100 + w_t)}{100,000}$$

where  $m_w$  = wet mass of specimen (g)  
 $\rho_t$  = target dry density (t/m<sup>3</sup>)  
 $V_c$  = net calibrated volume of shearbox (mm<sup>3</sup>)

$w_t$  = target moisture content (%)

8.3.2 Calculate the wet mass of soil for a layer as follows:

$$m_{w1} = \frac{m_w h_1}{h_c}$$

where  $m_{w1}$  = wet mass of soil for a layer (g)  
 $m_w$  = wet mass of specimen (g)  
 $h_1$  = thickness of compacted layer (mm)  
 $h_c$  = net calibrated height of shearbox (mm)

## 8.4 Density

8.4.1 Determine the volume of each specimen prior to shear as follows:

$$V_s = V_c - (A(r_f - r_i))$$

where  $V_s$  = volume of specimen prior to shear (mm<sup>3</sup>)  
 $V_c$  = net calibrated volume of shearbox (mm<sup>3</sup>)  
 $A$  = area of shearbox (mm<sup>2</sup>)  
 $r_f$  = vertical displacement immediately prior to commencing shearing (mm)  
 $r_i$  = initial vertical displacement reading at set-up (mm)

8.4.2 Calculate the dry density for each specimen prior to shear as follows:

$$\rho_{ds} = \frac{\rho_t V_c}{V_s}$$

where  $\rho_{ds}$  = dry density prior to shear (t/m<sup>3</sup>)  
 $\rho_t$  = target dry density (t/m<sup>3</sup>)  
 $V_c$  = net calibrated volume of shearbox (mm<sup>3</sup>)  
 $V_s$  = volume of specimen prior to shear (mm<sup>3</sup>)

## 8.5 Rate of horizontal displacement

8.5.1 Calculate the time to failure of each specimen as follows:

$$t_f = 12.7t_{100}$$

where  $t_f$  = time to failure (minutes)  
 $t_{100}$  = time required for 100% primary consolidation to occur (minutes)

8.5.2 Estimate the horizontal displacement required to reach constant volume conditions (Note 106).

8.5.3 Calculate the rate of horizontal displacement as follows:

$$rate = \frac{d_{cv}}{t_f}$$

where  $d_{cv}$  = estimated horizontal displacement (mm)  
 $t_f$  = calculated time to failure (minutes)

## 8.6 Effective angle of internal friction

8.6.1 From plots of vertical displacement against horizontal displacement and shear load against horizontal displacement, determine the horizontal displacement and the shear load at which the vertical displacement becomes constant for each.

8.6.2 Calculate the shear stress at constant vertical displacement for each specimen as follows:

$$\tau_{cv} = \frac{P_{cv} 10^{-6}}{A}$$

where  $\tau_{cv}$  = shear stress at constant vertical displacement (kPa)  
 $P_{cv}$  = shear load at constant vertical displacement (kN)  
 $A$  = cross-sectional area of shear box (mm<sup>2</sup>)

8.6.3 Plot each calculated shear stress at constant vertical displacement,  $\tau_{cv}$  on the y-axis against the corresponding normal stress at constant vertical displacement,  $\sigma_n$  on the x-axis using the same linear scale for both the y and x axes.

8.6.4 Determine an imposed line of regression through the origin in the form  $y = a x$  using the plotted points

$$\text{where } a = \frac{\sum xy}{\sum x^2}$$

8.6.5 Determine the effective angle of internal friction at constant volume conditions as follows:

$$\phi'_{cv} = \tan^{-1} a$$

where  $\phi'_{cv}$  = effective angle of internal friction at constant volume conditions.

## 8.7 Stress/strain

8.7.1 Calculate the shear strains for each specimen as follows:

$$\gamma = \frac{100(l - l_i - d)}{h_c - (r_f - r_i)}$$

where  $\gamma$  = shear strain (%)  
 $l$  = horizontal displacement gauge reading during shearing (mm)  
 $l_i$  = initial horizontal displacement gauge reading (mm)  
 $d$  = horizontal load ring compression during shear (mm) (Note 10.7)  
 $h_c$  = net calibrated height of shearbox (mm)  
 $r_f$  = vertical displacement reading immediately prior to commencing shearing (mm)  
 $r_i$  = initial vertical displacement reading at set-up (mm)

8.7.2 Calculate the volumetric strains for each specimen as follows:

$$\varepsilon_v = \frac{100(r - r_f)}{h_c - (r_f - r_i)}$$

where  $\varepsilon_v$  = volumetric strain (%)  
 $r$  = vertical displacement reading during shearing (mm)  
 $r_f$  = vertical displacement reading immediately prior to commencing shearing (mm)  
 $h_c$  = net calibrated height of shearbox (mm)  
 $r_i$  = initial vertical displacement reading at set-up (mm)

8.7.3 Calculate the shear stresses, during shearing, for each specimen as follows:

$$\tau = \frac{P \cdot 10^6}{A}$$

where  $\tau$  = shear stress during shearing (kPa)  
 $P$  = shear load during shearing (kN)  
 $A$  = cross-sectional area (mm<sup>2</sup>)

## 9 Reporting

The following shall be reported:

### 9.1 Moisture/density relationship results used for compaction:

- a) Where MDD and OMC is used:
  - i. MDD to the nearest 0.01 t/m<sup>3</sup>
  - ii. OMC to the nearest 0.5%
- b) Where minimum and maximum dry density is used:
  - i. Minimum dry density to the nearest 0.01 t/m<sup>3</sup>
  - ii. Maximum dry density to the nearest 0.5%

### 9.2 Shear results

- a) The effective angle of internal friction at constant volume conditions for the sample to the nearest 0.5°.
- b) Plot of shear stress (kPa) against normal stress (kPa) using the same linear scale for both horizontal and vertical axes with the imposed line of regression through the origin shown.
- c) Plot of shear stress and volumetric strain against shear strain (Figure 3).
- d) Horizontal displacement at constant volume for each specimen to the nearest 0.01 mm.
- e) Plot of vertical displacement against root time showing consolidation curves for each of the applied normal loads.

### 9.3 Placement conditions

- a) Specimen preparation details, including drainage conditions.
- b) The target dry density for each specimen to the nearest 0.01 t/m<sup>3</sup>.
- c) The target moisture content for each specimen to the nearest 0.1%.
- d) The dry density prior to shear for each specimen to the nearest 0.01 t/m<sup>3</sup>.
- e) The moisture content for each specimen after shearing to the nearest 0.1%.

### 9.4 Test conditions

- a) The test conditions and test type.
- b) Normal stress and shear stress at constant volume conditions for each specimen to the nearest 1 kPa.
- c) The rate of shearing (mm/minute).

### 9.5 The number of this Test Method, that is Q181C.

## 10 Notes on method

### 10.1 A test portion mass of about 30 kg should be sufficient for this purpose.

- 10.2 Layer thickness may vary for different shearboxes. However, layers should be thick enough to completely envelop the largest particles, but not so thick that a uniform compacted density is not achievable for their full depth.
- 10.3 Settlement is denoted as a positive value with decreasing specimen height resulting in an increase in the vertical displacement reading.
- 10.4 At times it may be difficult to draw a tangent to the early portion of the consolidation curve as this portion up to about 50% consolidation is not linear. The following technique is useful in providing a reasonable estimation of  $\sqrt{t_{100}}$ :
- 10.4.1 Locate the earliest point at which consolidation is substantially complete, that is, the point beyond which the vertical displacement vs root time curve virtually flattens out.
- 10.4.2 Bisect the horizontal distance between this point and the vertical axis. Read off the value on the horizontal axis corresponding to the halfway point. This value is the  $\sqrt{t_{100}}$ .
- 10.5 Separating the two halves of the shearbox is normally done by using parting screws. A gap of approximately 1 to 2 mm is normally sufficient.
- 10.6 For compacted soils, the horizontal displacement is estimated to be 15 to 25 mm for the 300 mm box.
- 10.7 Correction of horizontal displacement for compression in the shear load ring is only necessary if the horizontal displacement gauge is mounted independently of the carriage. No correction is necessary if using a load cell to capture shear load data.

**Table 1 – Requirements for displacement measuring devices**

Requirement	Minimum resolution (mm)	Maximum indicated error (%)	Maximum repeatability
Height of specimen	0.01	± 1.0	± 1.0
Horizontal displacement during shear	0.01	± 1.0	± 1.0

**Table 2 – Conditions for specimen preparation**

Maximum particle size	≤ 4.75 mm		> 4.75 mm	
Method of preparation	Q101B		Q101C	
% passing 0.075 mm*1	< 5	≥ 5	< 5	≥ 5
Test Method to determine compaction criteria	AS 1289.5.5.1	AS 1289.5.1.1	AS 1289.5.5.1	AS 1289.5.1.1
Target dry density ( $\rho_t$ )	70% Density Index	97% MDD	70% Density Index	97% MDD
Target moisture content ( $w_t$ )	Sufficient to aid compaction	95-105% OMC	Sufficient to aid compaction	95-105% OMC

Note 1: \* Material < 0.075 mm as a percentage of the passing 19.0 mm component of the sample



Figure 1 – Shearbox assembly (schematic)

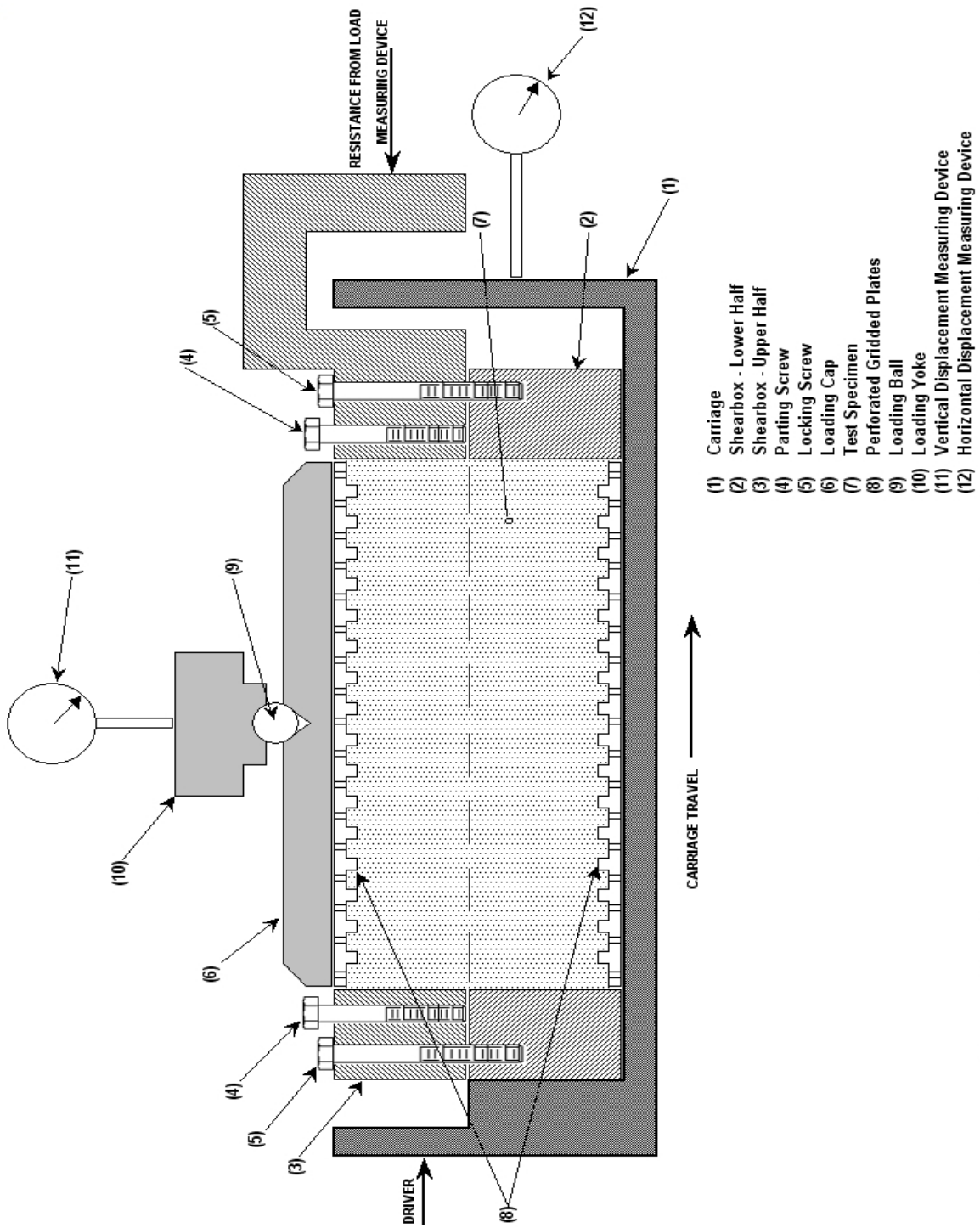

Figure 1 - Shearbox Assembly (Schematic)

Figure 2 – Consolidation point

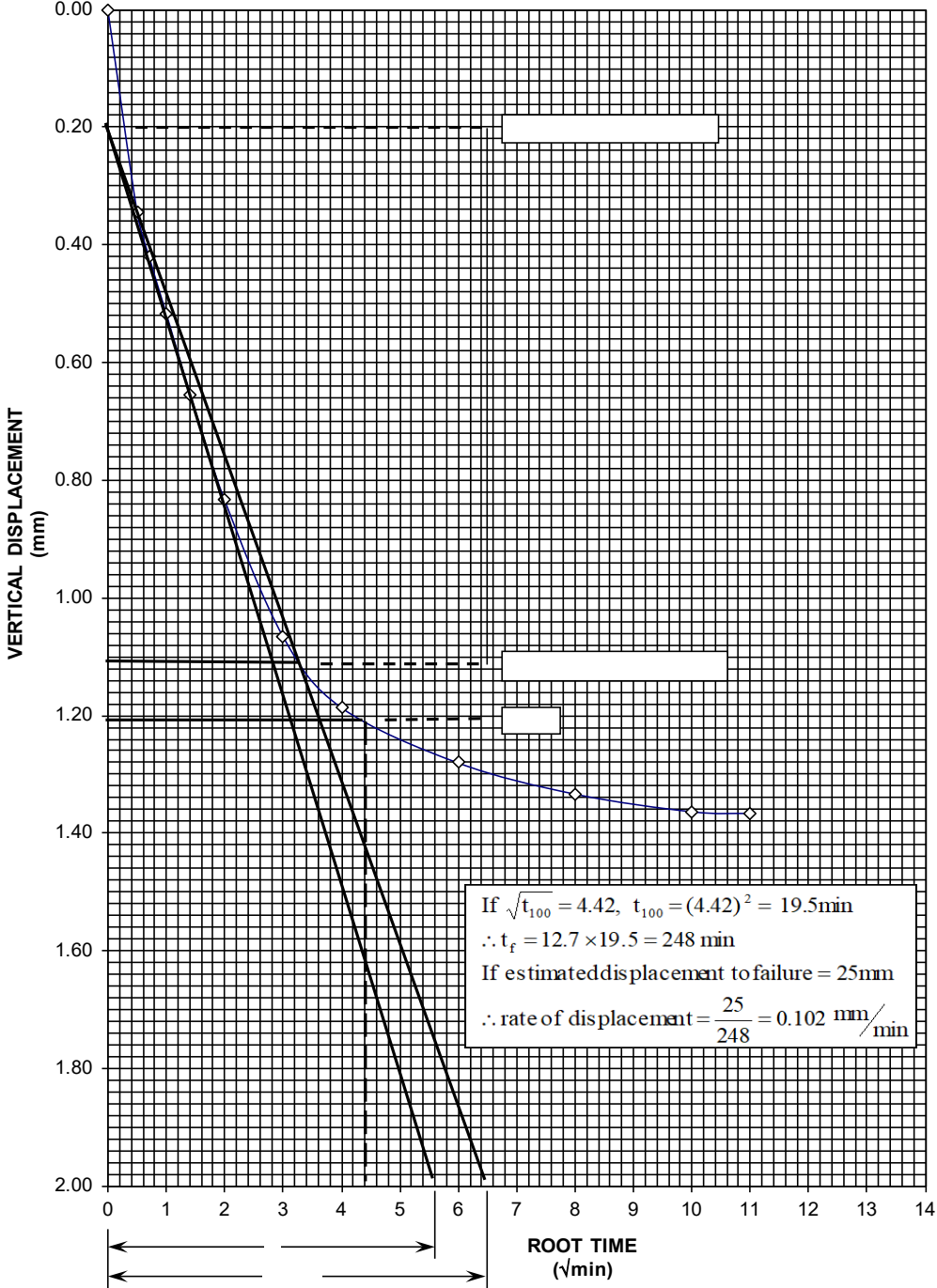
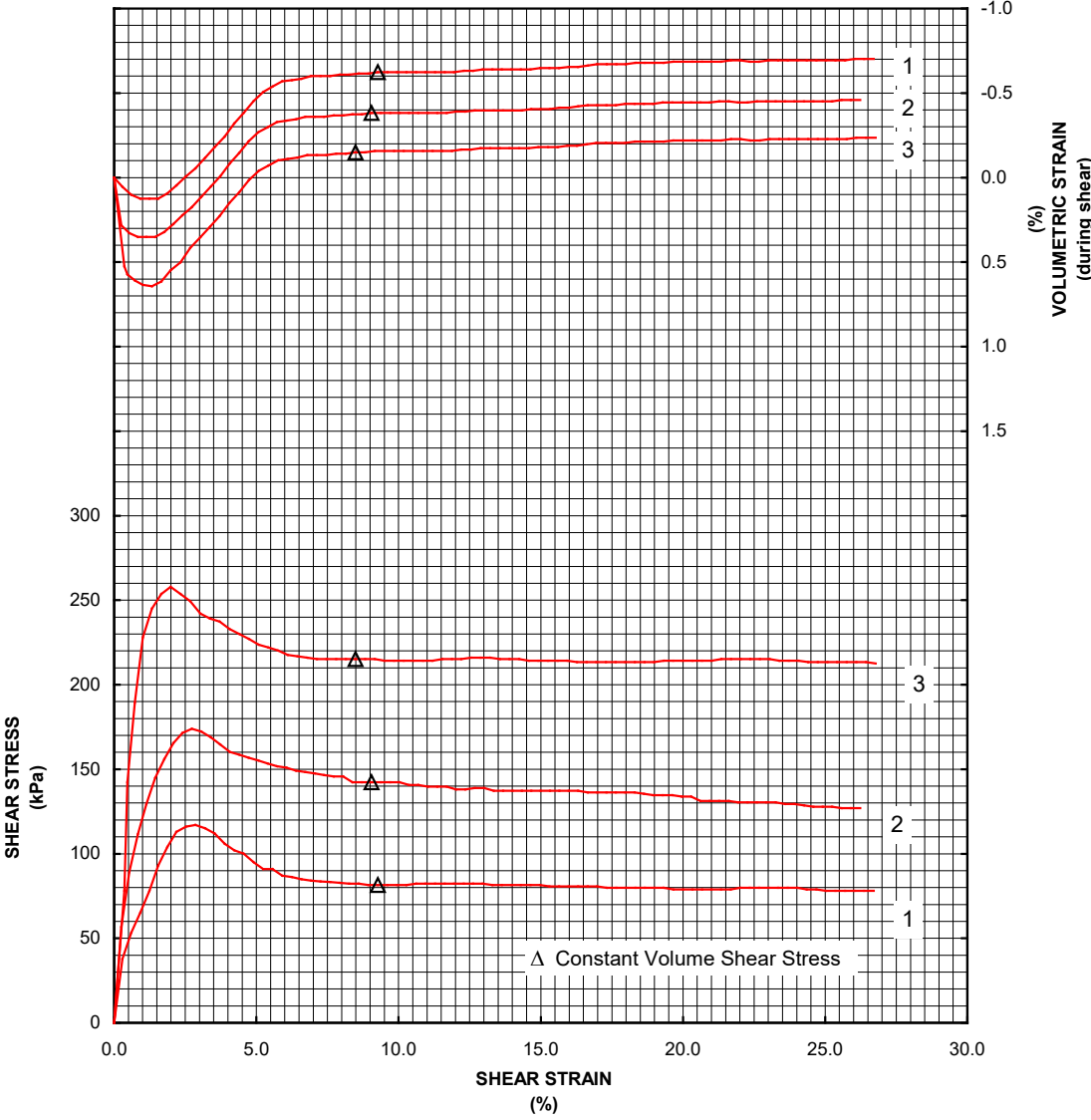

Figure 3 – Typical plot of test data



## Test Method Q188: Petrographic assessment of aggregates

### 1 Source

This Test Method is based on ASTM C295: *Standard Guide for Petrographic Examination of Aggregates for Concrete* or AS 1141.65: *Alkali aggregate reactivity – Qualitative petrological screening for potential alkali silica reaction*, but has been modified for the petrographic assessment of source rocks and quarry products for the purposes of registration in the Transport and Main Roads Quarry Assessment and Registration System (QRS).

### 2 Scope

This Test Method describes the additional requirements related to all the quarried materials, natural sands and natural gravels used by the department, including concrete and asphalt aggregates, base and sub-base materials and various other specialised quarry products such as armour stone.

This method describes the procedure and/or terminology for the determination of the following in relation to quarried products:

- materials group
- asbestos content
- an initial evaluation of its Alkali Aggregate Reactivity (AAR) potential
- total sodic and potassic feldspar and other mineral content
- mica content of sands
- 'quartz' content
- sulphide mineral content
- content of moisture sensitive minerals, and clay minerals
- total carbonate content
- total glass content and natural glass / man-made glass proportion, and
- nomenclature to be used, particularly in relation to basalts.

The method is based upon petrographic examination of representative thin sections or grain mounts of the material. No attempt is made to describe in detail the techniques of section preparation, mineral identification and petrographic description since it is assumed that the Test Method will be used by operators with adequate qualifications and experience to undertake the work and using suitable published methods. Regarding the Alkali Silica Reactivity (ASR) potential, this is, at best, only a first pass assessment; if a further assessment is required, then other specific ASR assessment tests should be used.

The aim of this document is to formalise and standardise, as far as is practical, the reporting of specific minerals, which may have deleterious or beneficial impacts on quarried materials.

### 3 Definition of terms

**Table 3 – Definition of terms**

Term	Definition
<b>Acid igneous group</b>	An igneous rock containing more than 65% SiO <sub>2</sub> typically consisting of quartz, feldspar, biotite. Includes rhyolite, rhyodacite, dacite, granite, adamellite and granodiorite tuffs or pyroclasts (of same composition).
<b>Asbestos</b>	One or more of the asbestos minerals (as defined in the <i>Work Health and Safety Act 2011</i> as being: actinolite, grunerite or amosite, anthophyllite, chrysotile, crocidolite and tremolite) occurring in their asbestiform habit. An asbestos mineral, but not in its asbestiform habit shall not be included as asbestos. A formal statement regarding asbestos is required for all quarry products.
<b>ASR minerals (Alkali Silicate Reaction)</b>	The following minerals or species are known to be susceptible to ASR (Note 8.1): <ul style="list-style-type: none"> <li>• Tridymite and cristobalite.</li> <li>• Strained quartz, quartz grains which show undulatory extinction when viewed under crossed polars. Where the extinction angle variation in the range of 10°–20° the grain is as classed as moderately strained, and &gt; 20° is classed as highly strained.</li> <li>• Chert (arbitrarily defined herein as polycrystalline, cryptocrystalline or microcrystalline quartz with a grain size finer than 0.01 mm and includes chalcedony, flint), including finely crystalline acid volcanic lithics.</li> <li>• Opal, a siliceous gel-like material, extremely fine-grained, amorphous form of silica.</li> <li>• Siliceous volcanic glass containing reactive silica, silica free glass shall not be included.</li> </ul>
<b>Basic igneous group</b>	An igneous rock containing between 44%–54% SiO <sub>2</sub> typically consisting of plagioclase, pyroxene, olivine and quartz free. Includes basalt, dolerite and gabbro and tuffs or pyroclasts (of same composition).
<b>Carbonate material content</b>	Both the total carbonate content and the proportion of each of the carbonate minerals which are present in the sample. The following carbonate minerals are of interest: calcite, aragonite, magnesite, dolomite and siderite.
<b>Clay (and similar) mineral content</b>	The total content of clays and moisture sensitive minerals, including kaolinite, smectite, sericite, chlorite, iddingsite, illite and zeolites.
<b>Coarse or fine gained product</b>	For this procedure a coarse gained product is one dominated by material coarser than 4.75 mm, while a fine-grained product is dominated by materials finer than 4.75 mm. In both cases some material finer or coarser than these limits may be included. In the case of fine concrete and fine asphalt aggregates the coarse / fine boundary is at 2.36 mm.
<b>Duricrust</b>	A hard siliceous or ferruginous or calcareous crust formed on a then-existing rock surface. In Queensland, this typically occurred during tertiary age, in semi-arid environments produced by the precipitation of silica (silcrete), iron oxides (ferricrete), or calcite (calcrete). The term 'laterite' is a general term: 'caliche' or 'hard pan' are also often used to describe essentially the same material, particularly if high ferruginous.
<b>Felspathoids</b>	A group of aluminosilicate minerals chemically similar to feldspar but containing less silica (or silica undersaturated), such as nepheline and leucite.

Term	Definition
<b>Glass</b>	Percent of glass, either natural glass or man-made glass. Natural glass will only be present in volcanic source rocks while man-made glass will only be in samples of quarried products with recycled glass added as a source of fines in concrete and asphalt products or in fully recycled materials.  In the case of natural glass, it should be differentiated into Volcanic non-silica glass (for example, mesostasis or microlite) and silica saturated glass.
<b>High sodium / potassium mineral content</b>	The total percentage, and individual content, of high sodium feldspars (for example albite and oligoclase), potassic feldspars (for example orthoclase microcline, sanidine), feldspathoids (for example nepheline, leucite), and zeolites (for example natrolite). This is particularly applicable to acid igneous rocks.
<b>Intermediate igneous group</b>	A rock which has formed by solidification from a melt or partial melt. An igneous rock containing between 54%–65% SiO <sub>2</sub> typically consisting of plagioclase, amphibole, pyroxene and nil or minor quartz. Includes trachyte, trachyandesite, andesite, syenite, diorite and tuffs or pyroclasts (of same composition).
<b>IUG</b>	International Union of Geological Sciences.
<b>Lithology</b>	The geological nomenclature of a rock based on one or more of colour, grain size, texture and mineralogical composition.
<b>Manufactured sand</b>	Sand produced by crushing a rock source material in a quarry. Manufactured sand is commonly used as a partial replacement for natural sand in concrete aggregates. Manufactured sand is classified as a fine aggregate that generally passes a 2.36 mm test sieve. May also be referred to as 'man-sand'.
<b>Metamorphic group</b>	A rock derived from a pre-existing rock by mineralogical, or structural changes in response to changes in the temperature and/or pressure. Includes hornfels, quartzite, metagreywacke, greenstone, slate and amphibolite.
<b>Mica content</b>	Only for sands, is defined as percent of individual flakes of mica (of any type), in the total sand mass. Composite grains including some mica (but not all mica) are not to be included.
<b>Materials group</b>	A classification system used in departmental Technical Specifications (for example, Technical Specification MRTS05 <i>Unbound pavements</i> ) for rocks based on their mineralogy and mode of occurrence.  These classes are like those of AS 1726 but differ in one fundamental way related to the classification of pyroclastic rocks. Such materials are placed in the same group as their volcanic equivalents rather than as in geological classification systems where they are classed as sediments (as in AS 1726). For Transport and Main Roads Technical Specification requirements, acceptable materials groups are: acid igneous, intermediate igneous, basic igneous, metamorphic, sedimentary, duricrust, and fines.
<b>Natural fines</b>	A classification term of the material group used to describe natural predominately sand deposits that generally pass through 2.36 mm-size sieve.
<b>Natural gravel</b>	Naturally occurring granular material sourced from alluvial, colluvial or residual deposits that generally retain on 2.36 mm-size sieve and pass through 4.25 mm sieve.

Term	Definition
<b>Quarry</b>	<p>A site from which construction materials are won by blasting, ripping or other excavation means for use in their natural states or after processing such as crushing, screening or combining with other materials. The term <i>quarry</i> also includes pits and natural deposits such as sand sources.</p> <p>When used in relation to Transport and Main Roads' <a href="#">quarry registration system</a>, a quarry may also include a material recycling site.</p>
<b>Quartz content</b>	<p>For the purposes of this method, 'quartz' is defined to comprise the total of the following components: this is different from ASR minerals (Note 8.2):</p> <ul style="list-style-type: none"> <li>• quartz which is present as single or compound mineral grains.</li> <li>• only the quartz content of clasts where quartz is locked in with other minerals in lithic clasts, not the total of all such clasts.</li> <li>• chert (arbitrarily defined herein as polycrystalline, cryptocrystalline or microcrystalline quartz with a grain size finer than 0.01 mm, chalcedony, flint).</li> <li>• opal which may be present as mineral grains or as an infilling or mineral coating.</li> </ul>
<b>Silica oversaturated (or Oversaturated)</b>	<p>In relation to the classification of basalts (Table 6.11), when excess or reactive silica is present within the rock fabric and/or cavities as glass.</p>
<b>Silica undersaturated (or Undersaturated)</b>	<p>In relation to the classification of basalts (Table 6.11), when no free silica is present within the rock fabric as glass. Instead, silica glass, rock fabric should consist of non-silica glass such as mesostasis or microlite.</p>
<b>Sedimentary group</b>	<p>A rock formed from loose sediments or by biological activity which have, via the process of lithification been transformed into rock. Including limestone, mudstone, sandstone, arenite, chert. pyroclastic rocks are not included in the sedimentary group but rather in their volcanic equivalents.</p>
<b>Source material group</b>	<p>A classification system used in departmental specifications for rocks based on their mineralogy and mode of occurrence.</p> <p>These classes are like those of AS 1726 but differ in one fundamental way related to the classification of pyroclastic rocks. Such materials are placed in the same group as their volcanic equivalents rather than as in geological classification systems where they are classed as sediments (as in AS 1726).</p>
<b>Sulphide mineral content</b>	<p>The total sulphide minerals content including the various iron sulphides and sulphides of the other metals. The most common sulphide mineral is pyrite, but another critical sulphide mineral is pyrrhotite. The sulphides mineral content is the sum of all sulphides not just pyrite.</p>

#### 4 Apparatus

The following apparatus is required:

- 4.1 Facilities, adequate for the preparation of thin sections of rocks and epoxy stabilised blocks for sand.

#### 4.2 Microscopes:

- a) a petrographic (polarising) microscope equipped with low, medium and high power objectives, an ocular lens containing crosshairs and a mechanical stage suitable for incremental traversing
- b) a binocular microscope for the examination of the sample generally under low power ( $\geq x50$ ), and
- c) all microscopes should have the capacity to take colour images.

#### 4.3 Point counter, suitable for recording the number of points observed in the course of incremental traversing

#### 4.4 For handling sand samples:

- a) Sample divider (riffle)
- b) Cone and quartering equipment
- c) Water bottle/spray suitable for wetting sand
- d) Scoop, spatula and tray for mixing sand

## 5 Procedure

### 5.1 The sample

Almost any type of sample could be used for a petrographic assessment; however, the sample used must be representative of all or part of the source rock in the quarry. If the sample is representative of part of a site, then the area of which it is representative should be clearly defined.

Potential sample types:

- Hand specimen (or core sample): The representativeness of such samples is a real issue, if hand specimens (or core samples) are used, then it would be expected that several such samples must be examined. A single sample is not adequate.
- Product samples: Product sample should be at least 20 kg sample of the highest quality product class produced at the quarry. Such sample should be either a sample of Technical Specification MRTS05 *Unbound pavements* Sub type 2.1 or a sample of screenings (preferably 14 mm or 12 mm screenings) or a sample of coarse concrete aggregate.
- Fines: If the site is an exclusive source of fine aggregates (sand), a 2 kg sample of such fines is required. If the site produces manufactured sand, then a 2 kg sample of manufactured sand is required.
- Manufactured sand: Quarries producing manufactured sand must provide a sample of such a product for analysis.

Minimum sample requirements for QRS registration:

- Hard rock quarries producing a limited range of products but including paving materials and/or concrete aggregates. A 20 kg sample of coarse concrete aggregate or Subtype 2.1.
- Hard rock quarries producing a wide range of products. A 20 kg sample of screenings or coarse concrete aggregate and a 20 kg sample of Subtype 2.1.



- Hard rock quarry producing manufactured sand. A 2 kg representative sample of manufactured sand, in addition to the above.
- A proposed quarry site not yet in production. Either at least two hand specimens or core samples. Such samples should be collected by an experienced geo-professional who was involved in the assessment of the site and who can attest to the relevance of the samples to the proposed site.
- Natural sand sources. A 2 kg sample of sand.

## **5.2 Sand samples (fine aggregates, manufactured sand and natural sand)**

- 5.2.1 Obtain two representative subsamples of the sand, each between 10–20 g, using a riffle splitter or by coning and quartering. To minimise segregation during handling, any dry sand sample must first be moistened with water so that it is damp, yet in a free-flowing condition. Ensure that sample division does not result in the removal of specific minerals (such as mica) during the process.
- 5.2.2 Using one entire sub-sample, mould and prepare a thin section using recognised techniques.
- 5.2.3 As well as determining the mineral content, also determine the content of glass.

## **5.3 Binocular examination**

Where aggregates samples are used, the uniformity of the sample shall be accessed using a binocular microscope, or simply by eye. This procedure allows the sample to be divided into sub-samples of similar type. The percentage of each sub-type can then be determined, by counting or weighing the fragments of each type. Identification of each of these sub-types is generally undertaken using petrographic examination.

## **5.4 Sample preparation – rock hand specimen or crushed coarse aggregate**

If a rock hand specimen, prepare one or more thin sections of the sample.

If a crushed coarse aggregate, first separate out representative sub-samples of each type as observed during binocular examination and, then prepare one or more thin sections containing a representative sample of each material sub-type.

## **5.5 Petrographic examination**

In general, perform a petrographic examination of the thin section using transmitted polarised light microscopy, supplemented by binocular microscopic examination of the remaining material. Record sufficient petrographic observations on the morphology (grain size, shape, mineralogy) degree of deformation / straining, especially of quartz grains (mild, moderately or highly strained) and composition of the material to characterise the rock / sand for comparative purposes and to attract attention to any perceived deleterious characteristics. This essentially follows the requirements of ASTM C295. Estimates of major minerals shall be to the nearest 1% of the total sample.

Perform a point count (or estimate the proportion of each mineral in the grains) in the section of each of the previously identified grain types. The point count (if used) should involve sufficient observations to enable the percentages of the constituent minerals to be determined to the required precision.

For low frequency of occurrence minerals (each with less than 2% of the total sample), a higher point count density may be required, or estimations of occurrence should be made. For these minerals, the frequency of occurrence shall be reported to the nearest 0.2% of the total sample, unless otherwise stated.

## 6 Requirements

### 6.1 Sample

Details of the type or types of sample provided.

### 6.2 Materials Group

Several of the department's Technical Specifications have different limits, depending on the source material group (acid igneous, basic igneous, intermediate igneous, metamorphic, sedimentary or duricrust). Generally, source material group follows the requirements of AS 1726; however, there is one notable exception in that pyroclastic rocks are classified based on their volcanic equivalents rather than being placed in the sedimentary group. In the case of naturally occurring sands, these should be placed in the 'Fines' materials group, rather than based on the provenience of the sand. For manufactured sand, this should be placed in the same materials group as its source rock.

### 6.3 Quartz content

The quartz content (using the definition of quartz as contained in Section 3) shall be the sum of all 'quartz' minerals expressed to the nearest 1% of the total sample.

### 6.4 ASR potential

The reported percent content of each of the ASR minerals, as defined in Section 2 above (for example opal, tridymite, cristobalite, chert (as defined herein) and strained quartz), shall each be determined and recalculated as a percentage of the critical concentration as defined in Table 6.4(a). These values are termed the partial ASR values. The partial ASR values shall then be added, to determine the total ASR value and the samples classification determined in accordance with Table 6.4(b).

**Table 6.4(a) – ASR reactive minerals and critical concentrations**

Mineral (or mineral type) as defined in Section 3	Reactivity	Critical concentration
Opal	Substantial	< 0.5%
Tridymite	Substantial	< 1.0%
Cristobalite	Substantial	< 1.0%
Siliceous Volcanic Glass	Substantial	< 3.0%
Siliceous Volcanic Glass, where in the range 1% to 3%	Slow	3.0
Chert (as defined herein, includes chalcedony, flint and other species)	Slow	< 3.0%
Moderately Strained (optically) Quartz	Slow	< 5.0%
Highly Strained (optically) Quartz at < 5% of Quartz concentration	Slow	< 5.0%
Highly Strained (optically) Quartz at > 5% of Quartz concentration	Substantial	< 5.0%

**Table 6.4(b) – ASR classification terminology**

Total ASR value	Reactivity class	
	Slow > substantial	Slow ≤ substantial
	Terminology	
< 50	Innocuous	
50–100	Potentially reactive	
100–500	Slowly reactive	Substantially reactive
> 500	Substantially reactive	

ASR worked example

For example:

- Assume a sample consists of 0.6% cristobalite and 2.5% chert (as defined herein)
- Partial ASR value for cristobalite =  $0.6/1.0 = 0.6$  = Partial ASR value 60 (substantial)
- Partial ASR value for chert =  $2.5/3.0 = 0.83$  = Partial ASR value 83 (slow)
- Total ASR value = 143 and Slow > Substantial.

**Classification:** Slowly Reactive, since  $100 < \text{ASR value} < 500$ , and Slow  $\geq$  Substantial.

## 6.5 Asbestos

The presence or absence of asbestos in the sample. This is the 'asbestos minerals' existing in their asbestiform habit, not the presence of just 'asbestos minerals'. The requirement here relates to the observation of asbestos rather than an estimate of concentration. If no asbestos is observed, this should be explicitly stated; that is, 'No asbestos observed', otherwise 'Asbestos minerals observed'. No actual asbestos content is required as it is always expected to be very small < 1%.

## 6.6 High sodium / potassium minerals

The total content of these minerals (typically high sodic feldspar, potassic feldspars, potassic and sodic feldspathoids and potassic and sodic zeolites) in the sample shall be reported to the nearest 1%, based on point count or estimation. Only the total content is required, the individual contents may be required for compliance with Sub-section 7.1 and/or 7.2 of this Test Method.

## 6.7 Mica content of sand

The presence of mica flakes in sand shall be reported to the nearest 1%, based on either estimation or point count.

## 6.8 Sulphide content

During the examination of the sample, an estimate of the total sulphide content of the sample shall be made (either as an estimate or via point counts). The total estimated sulphide content shall be reported to the nearest 1%.

If, during the examination of the sample, the presence of even trace amounts of pyrrhotite are observed, then the concentration of this specific sulphide mineral shall also be reported to the nearest 0.1%.

### 6.9 Clays and moisture sensitive materials

The total content of clays and moisture sensitive minerals, generally secondary minerals, including kaolinite, smectite, chlorite, iddingsite, illite, kaolinite to the nearest 1%. The total estimated 'clay' content shall be reported to the nearest 1% via estimation or point count.

### 6.10 Carbonate content

Both the total carbonate content of the sample (to 1%) and the content of the various carbonate minerals observed in the sample. The total estimated 'Carbonate' content shall be reported to the nearest 1% via estimation or point count.

### 6.11 Nomenclature for Basalt

Generally, the nomenclature of rocks shall follow a standard geological classification system, such as the IUGS or similar system. Due to several issues with basaltic rocks, a detailed nomenclature for this group has been defined in Table 6.11, based on glass content and nature of the glass, that is, non-silica (silica undersaturated) volcanic glass and saturated silica glass (silica oversaturated). If the percentage of olivine is greater than 5% (>5%), olivine can be used as prefix in front of 'basalt'; for example, 'Glassy olivine basalt' (Note 8.3).

**Table 6.11 – Basalt nomenclature**

Non-silica glass (or silica undersaturated) content	Saturated silica (or silica oversaturated) glass content	Petrographic nomenclature	Simplified nomenclature
<1%	<1%	Basalt	Basalt
<1%	1-5%	Slightly oversaturated glassy basalt	Oversaturated glassy basalt
<1%	>5%	Oversaturated glassy basalt	
1-5%	<1%	Slightly undersaturated glassy basalt	Undersaturated glassy basalt
1-5%	1-5%	Slightly oversaturated and slightly undersaturated glassy basalt	Oversaturated glassy basalt
1-5%	>5%	Oversaturated and slightly undersaturated glassy basalt	
>5%	<1%	Undersaturated glassy basalt	Undersaturated glassy basalt
>5%	1-5%	Slightly oversaturated and undersaturated glassy basalt	Oversaturated glassy basalt
>5%	>5%	Oversaturated and undersaturated glassy basalt	

Report the total content of glass to 1% and the natural glass to man-made glass proportion, based on either estimation or point count. Include whether the natural glass is a silica or non-silica glass.

Other basaltic rocks (such as basanite, foidite and tephrite) that are low in silica or silica undersaturated aluminosilicates and rich in feldspathoid minerals (such as nepheline and leucite) shall also be classified under silica undersaturated basalt nomenclature.

## **7 Reporting**

The following shall be reported:

### **7.1 General**

- A basic petrographic description of the sample(s), incorporating observations on grain size, grain shape, fragment types, mineralogical assemblage including % occurrence, description, including lithology, primary rock forming minerals, accessory minerals and secondary minerals as per ASTM C295 and AS 1141.65.
- Where several lithologies are present in the sample, the percentage of each lithology and the description of each lithology shall be reported.
- The percent of mineral grains (or clasts) of various compositions.

### **7.2 Specific requirements**

In addition to the general requirements detailed above, report the following specific requirements:

- the nature of the sample provided by the applicant
- the nomenclature of the rock (refer to specific requirements regarding basalts) and possible origin
- the classification into one of the 'Source material groups'
- any observations of asbestos minerals in their asbestiform habit, presence reported as either 'Asbestos observed' or 'No asbestos observed'
- ASR terminology classification in accordance with Tables 6.4(a) and 6.4(b), as well as the concentration of the various minerals used to derive the ASR classification
- the total percent of 'high sodium / potassium minerals' as defined in this Test Method to the nearest 1%
- mica content of sands reported to the nearest 1%
- total quartz content to the nearest 1% (as defined herein), as well as the components of this quartz content
- total sulphide content of the sample to the nearest 1% and any observation (or absence) of pyrrhotite, including the percentage of occurrence
- the total clay content (to 1%) of the sample and identification of (as far as is possible) clay mineral types
- total carbonate content and the sample and the percentage of the various carbonate minerals, to the nearest 1%
- total glass content of the sample to 1%, the proportion of recycled glass to natural glass to the nearest 1% and, in the case of natural glass, the nature of the glass; that is, siliceous (silica oversaturated) or non-siliceous (silica undersaturated) glass.

### **7.3 Other**

Any pertinent comments which may bear on the perceived suitability of the material for its use as an aggregate or road making material.

7.4 The number of this Test Method, that is Q188.

## **8 Notes on method**

8.1 Not all quartz is defined as an ASR mineral.

8.2 Not all quartz grains are ASR mineral grain.

8.3 The term 'oversaturated' refers to the silica content of the glass, not the entire rock.

## Test Method Q191: Inspection of installed pavement drains - bore scope

### 1 Source

This Test Method applies the principles of the Virginia Department of Transport, Test Method 108, *Post Construction Inspection of Underdrains, Crossdrains, and Edgedrains* and the supporting specification Virginia Department of Transport Road and Bridge Specification Section 501 *Underdrains*.

### 2 Scope

This Test Method outlines the procedure for inspection of a pipe or strip filter drain (pavement drain) by bore scope to determine its condition.

### 3 Apparatus

The following apparatus is required:

- 3.1 Bore scope, an optical device consisting of the following:
  - a) rigid or flexible tube with an eyepiece at one end and an objective lens at the other, linked together by a relay optical system
  - b) with a maximum diameter of 10 mm
  - c) with a length of camera cable of at least 20 m, and
  - d) capable of capturing clear video images with a minimum resolution of 10,000 pixels.
- 3.2 A device to electronically record the images from the bore scope onto suitable recording media.
- 3.3 Drain locator, to establish the distance from the outlet of any pavement drain deficiencies.

### 4 Procedure

The procedure shall be as follows:

- 4.1 Feed the bore scope through the pavement drain at a rate not exceeding 5 metres per minute (Note 7.2).
- 4.2 Progressively record the condition of the pavement drain in terms of the following deficiencies, if any:
  - a) penetration by guardrail posts, signposts, delineator posts and so on
  - b) sag in the longitudinal profile of the pavement drain as evidenced by ponding of water for continuous lengths of 3.0 m or greater
  - c) any blocked or crushed pavement drain that will not allow the passage of the bore scope, and
  - d) any partially blocked or partially crushed/split/cracked pavement drain for any length greater than 300 mm.
- 4.3 Using the drain locator, determine and record the location of any deficient condition detected in accordance with Step 4.2.
- 4.4 Electronically record on suitable media the inspection condition of the pavement drain as shown by the bore scope.

4.5 Record the total length of the pavement drain inspected.

## **5 Calculations**

Calculations shall be as follows:

5.1 The total length of deficient condition recorded for the pavement drain.

5.2 The total length of deficient condition as a percentage of the total length of pavement drain inspected.

## **6 Reporting**

The following shall be reported:

6.1 Inspection date.

6.2 Project identification.

6.3 Pavement drain location, for example, chainage / offset.

6.4 Pavement drain manufacturer and product name.

6.5 Pavement drain inspection length.

6.6 Location from the outlet and nature of any deficient condition in accordance with Step 4.2.

6.7 Length of deficient condition as a percentage of the total length inspected, and

6.8 The number of this Test Method, that is Q191.

## **7 Notes on method**

7.1 The optical system is usually surrounded by optical fibres contained within a rigid or flexible protective outer sheath to illuminate a remote object. An internal image of the remote object is formed by the objective lens and relayed to the eyepiece that magnifies the internal image and presents it to the viewer's eye.

7.2 Where an outlet location is inaccessible with the bore scope, visual inspection is permitted.



## Test Method Q192: Robustness of geotextiles

### 1 Source

This procedure was developed using Austroads (2009) *Guide to Pavement technology Part 4G: Geotextiles and Geogrids*.

### 2 Scope

This Test Method describes the calculation of the robustness (G rating) of a geotextile.

The robustness is a relationship between the burst strength and puncture resistance of a geotextile. It is used in Transport and Main Roads [Technical Specification MRTS27 Geotextiles Separation and Filtration](#) to classify the strength of geotextiles.

### 3 Procedure

The procedure shall be as follows

- 3.1 Obtain a minimum of 10 test specimens cut from the longitudinal direction and a minimum of 10 specimens cut from the transverse direction of the sampled roll in accordance with AS 3706.1.
- 3.2 Determine the CBR burst strength of a geotextile ( $L$ ) for at least 10 specimens in accordance with Test Method AS 3706.4.
- 3.3 Determine the drop cone puncture resistance, which is the drop height required to make a hole 50 mm in diameter ( $h_{50}$ ) for at least 10 specimens in accordance with Test Method AS 3706.5.

### 4 Calculations

Calculations shall be as follows:

- 4.1 Calculate the minimum characteristic value of CBR burst strength ( $L$ ) and drop cone puncture resistance ( $h_{50}$ ) using an acceptance constant  $k = 1.645$  in accordance with Test Method Q020.
- 4.2 Calculate the G rating as follows:

$$G = \sqrt{Lh_{50}}$$

where

$G$	=	G rating
$L$	=	minimum characteristic CBR burst strength (N)
$h_{50}$	=	minimum characteristic drop cone puncture resistance (mm)

### 5 Reporting

The following shall be reported:

- 5.1 Tabulation of CBR burst strength and drop cone puncture resistance results (refer to AS 3706.4 and AS 3706.5).
- 5.2 Mean, standard deviation and minimum characteristic values for CBR burst strength and drop cone puncture resistance (refer to Test Method Q020).

- 5.3 G rating to the nearest 50.
- 5.4 The number of this Test Method, that is, Q192.

## Test Method Q201: Flakiness index of aggregate

### 1 Source

This Test Method applies the principles of AS 1141.15: *Flakiness index* except as follows:

- a) by including 6.70–4.75 mm slots in the thickness gauge
- b) by using Test Method Q103A for the determination of the particle size distribution, and
- c) by changing the calculations to allow for test fractions to be taken from subsampled materials.

### 2 Scope

This Test Method describes a procedure for determining the flakiness index of unbound materials used in pavements. The Test Method applies to aggregates having a nominal size not greater than 63.0 mm.

### 3 Definitions

For this Test Method, the following definitions shall apply:

- 3.1 Mean dimension - the mean of the smallest sieve aperture through which the particle passes and the largest sieve aperture on which the particle is retained.
- 3.2 Flaky particle - a particle with a least dimension (thickness) less than 0.6 of its mean dimension.
- 3.3 Flakiness index - the percentage by mass of flaky particles.

### 4 Apparatus

Example of a thickness gauge is contained in AS 1141.15 Figure 1.

The following apparatus is required:

- 4.1 Balance of suitable capacity, having a resolution of at least 1 g and with a limit of performance not exceeding  $\pm 5$  g.
- 4.2 Drying oven of suitable capacity, having a temperature of 105–110°C and conforming to AS 1141.2.
- 4.3 Slotted sieves, with apertures conforming to the dimensions shown in Table 1.
- 4.4 Thickness (flakiness) gauge with apertures conforming to the dimensions shown in Table 2 (Note 8.1).
- 4.5 Sieves, 63.0 mm, 53.0 mm, 37.5 mm, 31.50 mm, 26.5 mm, 19.0 mm, 13.2 mm, 9.50 mm, 6.70 mm and 4.75 mm as required, conforming to ISO 3310.
- 4.6 Sieve brushes.
- 4.7 Container of suitable size, for drying the test portion.
- 4.8 Dishes and trays.

The following apparatus may be used:

- 4.9 Mechanical sieve shaker.

## 5 Procedure

The procedure shall be as follows:

### 5.1 Particle size distribution

- 5.1.1 Prepare the bulk sample in accordance with Section 4 of Test Method Q101 to produce a representative test portion that, when dry, will conform to the minimum mass requirement of Test Method Q103A Table 1.
- 5.1.2 Place the test portion in the container and dry in the oven to a constant mass.
- 5.1.3 Determine the sieves required by consulting any applicable specification and the fractions required in Table 1 for the material under test.
- 5.1.4 Determine the particle size distribution of the sample in accordance with Test Method Q103A (Note 8.2), using the sieves required in Step 5.1.3.

### 5.2 Test fractions

- 5.2.1 Combine the size fractions retained on the sieves as necessary, into the fractions shown in Table 1.
- 5.2.2 Include all fractions which constitute five or more percent of the sample and are larger than 4.75 mm.
- 5.2.3 Obtain the mass of each test fraction as follows:
  - a) For fractions larger than 19.0 mm (that is, obtained from Test Method Q103A Subsection 6.1), determine the mass of each test fraction ( $m_1$ ) between 63.0 and 19.0 mm.
  - b) Where the sample has not been coarse sieved or the passing 19.0 mm material has not been subsampled (that is, obtained from Test Method Q103A Step 7.2.3), determine the mass of each test fraction ( $m_1$ ) between 19.0 and 4.75 mm.
  - c) Otherwise:
    - i. Determine the subsampled mass of each test fraction ( $m_2$ ).
    - ii. Calculate the mass of each test fraction ( $m_1$ ) between 19.0 and 4.75 mm as follows:

$$m_1 = m_2 \frac{M_d - M_c}{m_4 - m_3}$$

- where
- $m_1$  = mass of each test fraction (g)
  - $m_2$  = subsampled mass of each test fraction (g)
  - $M_d$  = mass of sample from particle size distribution (g); that is,  $m_2 - m_1$  obtained from Test Method Q103A
  - $M_c$  = cumulative mass retained on the 19.0 mm sieve (g), obtained from Test Method Q103A.
  - $m_3$  = mass of container (g), obtained from Test Method Q103A.
  - $m_4$  = mass of container and test portion subsample (g), obtained from Test Method Q103A.

### 5.3 Load on slotted sieves

Overloading of sieves may affect the accuracy of results and damage the sieves. The maximum loads on sieves at completion of sieving are set out in Table 3. To prevent overloading, divide the mass retained on the sieve into two or more portions of a mass less than the recommended loading in Table 2 and pass the separate portions through the sieve.

### 5.4 Method of shaking slotted sieve

5.4.1 When sieving is conducted by hand, a lateral and vertical motion is employed accompanied by a slight jarring action to keep the material moving continuously over the sieve. Particles 19.0 mm or larger may be placed by hand to pass the sieves.

5.4.2 When sieving is conducted using a mechanical sieve shaker, sieving is carried out for such time as will give a comparable result to hand sieving, which is generally 12–15 minutes.

5.4.3 At the end of sieving, hand sieve each portion retained until the mass passing each sieve in one minute is less than 1% of the mass of material retained on that sieve (Note 8.3).

### 5.5 Flakiness index

5.5.1 Test each fraction by either sieving the fraction on a slotted sieve or attempting to pass each piece of aggregate through the appropriate gauge slot using the size of the slot shown in Table 1.

5.5.2 Retain the aggregate passing through the slot (either sieve or gauge) and determine the mass of the aggregate passing the appropriate slot ( $m_5$ ).

## 6 Calculations

Calculations shall be as follows:

6.1 Calculate the total mass of sample from the particle size distribution as follows:

$$M_T = \sum m_1$$

where  $M_T$  = mass of sample from particle size distribution (g)

$m_1$  = mass of each test fraction (g)

6.2 For each test fraction calculate the percentage of aggregate passing each slot as follows:

$$P = \frac{100m_5}{m_1}$$

where  $P$  = percentage of aggregate passing slot

$m_5$  = mass of aggregate passing slot (g)

$m_1$  = mass of each test fraction (g)

- 6.3 For each test fraction calculate the weighted percentage of aggregate passing each slot as follows:

$$P_W = \frac{Pm_1}{M_T}$$

- where  $P_W$  = weighted percentage of aggregate passing each slot  
 $P$  = percentage of aggregate passing each slot  
 $m_1$  = mass of each test fraction (g)  
 $M_T$  = mass of sample from particle size distribution (g)

- 6.4 Calculate the flakiness index as follows:

$$FI = \sum P_W$$

- where  $FI$  = flakiness index (%)  
 $P_W$  = weighted percentage of aggregate passing each slot

## 7 Reporting

The following shall be reported:

- 7.1 Flakiness index to the nearest 1%.  
 7.2 The number of this Test Method, that is Q201.

## 8 Notes on method

- 8.1 The thickness gauge may be used as an alternative to slotted sieves. It is normal practice to use the thickness gauge for particles larger than 26.5 mm. The thickness gauge may not be suitable for aggregates that require the 6.70 mm to 4.75 mm fraction to be tested.  
 8.2 For ease in determining the flakiness index, it is advisable to keep the fractions retained on each sieve separated during the performance of Test Method Q103A.  
 8.3 Slotted sieves are intended to measure one dimension only. Any very elongated or wide particles that would otherwise pass through but are retained solely because the slots are not long enough, should be removed and placed with other flat particles.

**Table 1 – Slotted sieves**

Size fractions (mm)		Dimensions of rectangular slots (mm)		Minimum recommended	
Passing	Retained	Minimum length	Width*	Bridge between slots	Plate thickness#
63.0	53.0	90	34.80 ± 0.30	30	2.0
53.0	37.5	80	27.15 ± 0.30	30	2.0
37.5	31.5	70	20.70 ± 0.20	19	2.0
31.5	26.5	60	17.40 ± 0.20	17	2.0
26.5	19.0	50	13.65 ± 0.20	13	2.0
19.0	13.2	40	9.66 ± 0.20	10	2.0
13.2	9.50	30	6.81 ± 0.10	7	2.0
9.50	6.70	20	4.86 ± 0.10	5	2.0
6.70	4.75	15	3.44 ± 0.10	4	2.0

\* These widths are 0.6 times the mean of the limiting sieve apertures used to define the size fraction

# To provide support, rows of apertures should be staggered

**Table 2 – Thickness gauge**

Size fractions (mm)		Dimensions of rectangular slots	
Passing	Retained	Minimum length	Width*
63.0	53.0	90	34.8 ± 0.30
53.0	37.5	80	27.15 ± 0.30
37.5	26.5	70	19.20 ± 0.20
26.5	19.0	50	13.65 ± 0.20
19.0	13.2	40	9.66 ± 0.20
13.2	9.50	30	6.81 ± 0.10
9.50	6.70	20	4.86 ± 0.10
6.70	4.75	15	3.44 ± 0.10

\* These widths are 0.6 times the mean of the limiting sieve sizes used to define the size fraction.

**Table 3 – Recommended maximum slotted sieve loadings**

Size fractions (mm)		Slot width	300 mm diameter
Passing	Retained	(mm)	(g)
63.0	53.0	34.80	2600
53.0	37.5	27.15	1950
37.5	31.5	20.70	1450
31.5	26.5	17.40	1200
26.5	19.0	13.65	950
19.0	13.2	9.66	700
13.2	9.50	6.81	500
9.50	6.70	4.86	400
6.70	4.75	3.44	300



## **Test Method Q203: Polished aggregate friction value**

This Test Method shall be performed in accordance with Australian Standard Test Methods AS 1141.42: *Methods for sampling and testing aggregates, Method 42: Pendulum friction test* and AS 1141.40: *Methods for sampling and testing aggregates, Method 40: Polished aggregate friction value – Vertical road-wheel machine*.

## Test Method Q208B: Degradation factor of coarse aggregate

### 1 Source

This Test Method applies the principles of AS 1141.25.2: *Degradation factor – Coarse aggregate* except as follows:

- a) for minor alterations to the defined test portion
- b) using sieved instead of crushed material for the 4.75 mm to 2.36 mm test fraction
- c) for minor alterations to stock solution ingredients
- d) by modifying the washing technique during preparation
- e) by modifying the washing technique after abrasion, and
- f) by directly calculating the degradation factor.

### 2 Scope

This Test Method describes the procedure for the determination of the degradation factor of coarse aggregate (retained 2.36 mm sieve). The degradation factor indicates the aggregate quality by categorising the fines produced by the self-abrasion of the aggregate particles in the presence of water.

### 3 Apparatus

Where appropriate, the working tolerances of apparatus are contained in Table 1. Examples of test cylinder, Modified Tyler shaker and nested sieves and funnel are contained in AS 1141.25.2, Figures 1, 2(a) and 2(b).

The following apparatus is required:

- 3.1 Shaker, a motorised modified Tyler shake.
- 3.2 Canister, a plastic canister fitted with a close fitting lid.
- 3.3 Test cylinder, a cylinder consisting of a transparent measuring tube and base, with a rubber or plastic stopper and graduated from the base to a height of 380 mm in increments of 5 mm.
- 3.4 Measuring cylinders:
  - a) 500 mL measuring cylinder graduated at 100 mL intervals with a rubber or plastic stopper.
  - b) 10 mL measuring cylinder graduated at 1 mL intervals.
- 3.5 Sieves:
  - a) 19.0 mm, 13.2 mm, 9.50 mm, 6.70 mm, 4.75 mm and 2.36 mm sieves conforming to ISO 3310.
  - b) 2.36 mm sieve of 300 mm diameter and conforming to ISO 3310.
  - c) Reinforced 0.075 mm sieve of 300 mm diameter and conforming to ISO 3310.
- 3.6 Funnel, a funnel having an internal diameter of approximately 325 mm.
- 3.7 Timer, a timer capable of measuring at least 20 minutes and reading in minutes and seconds.
- 3.8 Sprayer, water sprayer, such as a vegetable sprayer.

- 3.9 Wash bottle with a fine jet.
- 3.10 Wash bowls, four metal bowls, approximately 180 mm diameter and 100 mm deep.
- 3.11 Drying oven of suitable capacity, having a temperature of 105-110°C and conforming to AS 1141.2.
- 3.12 Balances:
- balance of suitable capacity, having a resolution of at least 0.1 g and with a limit of performance within the range of  $\pm 0.5$  g, and
  - balance of suitable capacity, having a resolution of at least 0.01 g and with a limit of performance within the range of  $\pm 0.05$  g for weighing reagents.

## 4 Materials

The following materials are required:

- 4.1 Potable water.
- 4.2 Distilled water.

## 5 Reagents

The following reagents are required:

- 5.1 Stock solution:
- Prepare by dissolving  $21.9 \pm 0.2$  g of calcium chloride hexahydrate (AR grade) and  $48.0 \pm 0.5$  g of glycerine (99% glycerol (LR grade)) in distilled water and making up to 100 mL (Notes 11.1 and 11.2).
- 5.2 Record the date of preparation of the stock solution on the reagent bottle. Use the stock solution for 5 days from the date of preparation after which fresh stock solution needs to be prepared.

## 6 Sample preparation

The sample shall be prepared as follows:

- 6.1 Prepare the bulk sample in accordance with Section 4 of Test Method Q101 to produce a representative subsample of appropriate size.
- 6.2 Prepare a representative subsample to provide a test portion containing the fractions in Table 2as follows:
- Screen the subsample through each of the sieves listed in Table 2 in turn, breaking up aggregations of fines either by hand or by using a rubber pestle and mortar such that discrete particles are not broken.
  - Where difficulty exists in ascertaining whether particles are discrete or, in fact, aggregations of fines, a small number of such particles should be placed in water and boiled. If disaggregation occurs, such particles shall be considered as aggregations of fines.
  - Discard the material retained on the largest sieve and the material passing the smallest sieve.
  - Place the fractions in separate wash bowls and wash each fraction using potable water until all coatings of fines have been removed from the surface of the particles. Use the procedure and observe the precautions detailed below.

- a) Wash each fraction in turn as follows:
    - i. Hold the bowl at about a 45° angle in a sink and wash the particles, changing the orientation of the bowl to expose all particles to the water stream.
    - ii. Stop washing when the bowl is full and decant the wash water, ensuring only clay-sized particulates run to waste.
    - iii. Repeat the washing and decanting until the wash water is clear.
  - b) While the wash water is usually clean once all coatings of fines have been removed, some discrete rock particles will slowly break down when subjected to a stream of water. This is evidenced by discolouration of the wash water. In such cases, discontinue washing once the surface of the particles first appear clean to the naked eye (Note 11.3).
- 6.2.5 Place each washed fraction in the oven in its wash bowl and dry until a constant mass has been reached, recording the mass at each weighing.
- 6.2.6 Reduce each dried fraction to the required mass as per Table 2, using appropriately sized sample splitters in accordance with Test Method Q101 Step 4.3. Ensure each resultant subsample is representative of the washed fraction and includes any rock fragments and fines. Combine the four fractions to produce the test portion.

## 7 Procedure

The procedure shall be as follows:

- 7.1 Rinse the canister, lid, funnel, measuring cylinders, the 2.36 mm sieve, reinforced 0.075 mm sieve and the test cylinder using the sprayer with distilled water and allow the rinsed apparatus to drain.
- 7.2 Place the test portion in the canister, together with 200 mL of distilled water.
- 7.3 Place the lid on the canister and secure the assembly in the shaker.
- 7.4 Operate the shaker for 20 minutes.
- 7.5 After the 20 minutes shaking, empty the test portion into nested 2.36 mm and 0.075 mm sieves held in the funnel over the 500 mL measuring cylinder.
- 7.6 Wash out the canister with distilled water from the sprayer and continue to wash the aggregate with the water from the canister and distilled water until the measuring cylinder is full to the 500 mL mark. So the maximum amount of fines is deposited into the measuring cylinder, use the procedure and observe the precautions detailed below.
  - 7.6.1 Wash the canister and aggregate with sprayer and distilled water as follows:
    - a) Use a minimum amount of water to wash the canister, placing larger particles into the 2.36 mm sieve by hand. Direct the canister wash water over the material retained on the 2.36 mm sieve.
    - b) Separate and hold the 2.36 mm sieve just above the 0.075 mm sieve. Tilt the 2.36 mm sieve so that the wash water is directed over the retained 0.075 mm material. Remove fines by lightly tapping the 2.36 mm sieve and sparingly rinsing with water.
    - c) Clean the retained 0.075 mm material with water, tilting the sieve to allow drainage.
    - d) Tilt the 0.075 mm sieve and direct wash water over the back of the sieve. Remove fines by lightly tapping the back of the 0.075 mm sieve and sparingly rinsing with water.

- 7.6.2 Since some wash water will be held on and between the aggregate particles retained on the sieves and will drain slowly, the spray rate must be reduced as the level in the cylinder approaches 500 mL to prevent overfilling. The aggregate may drain 50-100 mL of wash water after the washing has ceased, thus allowance should be made for this extra wash water to drain.
- 7.6.3 With some soft discrete rock particles, the wash water will not be clear after washing.
- 7.7 If the level in the cylinder does not reach 500 mL at the end of washing and draining, top the cylinder up to 500 mL with distilled water using the wash bottle.
- 7.8 Using the 10 mL measuring cylinder, transfer 7 mL of stock solution into the graduated test cylinder.
- 7.9 Stopper the 500 mL measuring cylinder and bring all solids in the wash water into suspension by inverting the cylinder end to end about ten times allowing the bubble to travel completely from one end to the other each time.
- 7.10 Immediately pour the suspension into the test cylinder to the 380 mm mark and insert the stopper.
- 7.11 Mix the contents of the test cylinder by inverting the cylinder end to end, allowing the bubble to travel completely from one end to the other. This alternating end to end mixing cycle shall be repeated 20 times in approximately 35 seconds.
- 7.12 At the conclusion of the mixing period, place the test cylinder on a bench free from vibration, remove the stopper and start the timer. Allow the test cylinder to stand undisturbed for a period of 20 minutes  $\pm$  10 seconds.
- 7.13 After the 20 minute period, estimate and record the height of the upper surface of the flocculate column ( $h$ ) to the nearest 1 mm.

## 8 Calculations

Calculations shall be as follows:

- 8.1 Calculate the degradation factor ( $D$ ) as follows:

$$D = \frac{100(380 - h)}{380 + 1.75h}$$

where  $D$  = degradation factor  
 $h$  = height of flocculate column (mm)

## 9 Reporting

The following shall be reported:

- 9.1 Degradation factor to the nearest whole number.
- 9.2 If the wash water was clear or not clear after using the 500 mL of wash water in Step 7.6.3.
- 9.3 The number of this Test Method, that is Q208B.

## 10 Precision

The following criteria should be used to judge the acceptability of results (95% probability).

**10.1 Repeatability**

Duplicate tests by the same operator are acceptable if their results do not differ by more than four units.

**10.2 Reproducibility**

Independent test results obtained by different operators working in different laboratories on identical samples are acceptable if the results do not differ by more than 16 units.

**11 Notes on method**

11.1 Before handling the reagents, the operator should consult the relevant SDS.

11.2 Due to the very hygroscopic nature of calcium chloride hexahydrate, it will begin to dissolve in the water which it attracts, even in its original container once that has been opened. However, any undissolved crystals may be used by simply decanting any free solution from the calcium chloride hexahydrate container before use.

11.3 Insufficient washing may retain clay fines as adherent coatings. These are released subsequently during the test.

**Table 1 – Specifications and working tolerances of apparatus**

Item	Unit	Value	Working tolerance
<b>Shaker</b>			
Frequency	cycles/min	300	± 5
Throw (total)	mm	44	± 0.5
Pivot to base length	mm	520	± 5
Pivot to cam shaft length	mm	585	± 5
<b>Canister</b>			
Height	mm	150	approx.
Internal diameter	mm	190	± 5
Base thickness	mm	5	max.
<b>Test cylinder</b>			
Tube height	mm	430	approx.
Tube external diameter	mm	40	approx.
Tube internal diameter	mm	32	± 0.5

**Table 2 – Mass of fractions required for test portions**

Particle size (mm)	Mass of fraction (g)
13.2 to 9.50	250 ± 2.5
9.50 to 6.70	250 ± 2.5
6.70 to 4.75	250 ± 2.5
4.75 to 2.36	250 ± 2.5

## Test Method Q211: Binder absorption by aggregate

### 1 Source

This Test Method was developed in-house using techniques evolved through internal departmental research investigations. It applies the principles of Test Method AS 1141.6.1: *Particle density and water absorption of coarse aggregate – weighing-in-water method*.

### 2 Scope

This Test Method describes the procedure for determining the quantity of binder absorbed by an aggregate. Make two determinations of aggregate volume, one being the volume related to the aggregate particle density on a dry basis, and the other being the volume of the binder free aggregate following immersion of the aggregate in hot binder. Measure binder absorption by volume difference and expressed as a percentage by mass. The Test Method is applicable to aggregates used in asphalt mix.

### 3 Apparatus

The following apparatus is required:

- 3.1 Test oven, an oven of suitable capacity to hold two sample containers and capable of maintaining a temperature of  $150 \pm 5^\circ\text{C}$  for bitumen binders and  $180 \pm 5^\circ\text{C}$  for polymer modified binders.
- 3.2 Drying oven, of suitable capacity, having a temperature of  $105 - 110^\circ\text{C}$  and conforming to AS 1141.2.
- 3.3 Balance, a top pan balance of suitable capacity, with a resolution of at least 0.1 g and with a limit of performance within the range of  $\pm 0.5$  g, and capable of below balance weighing.
- 3.4 Balance bench, equipped with a hole for below balance weighing.
- 3.5 Basket, a wire basket of suitable mesh and capacity to contain the aggregate sample.
- 3.6 Attachment, a non-absorbent device to suspend the wire basket under the balance and inside the water container.
- 3.7 Water container, a container fitted with an overflow and filled with clean water to the overflow. With suitable dimensions to allow the basket and sample container to be completely immersed without contacting any part of the container.
- 3.8 Sample containers, two containers of at least 4 L capacity fitted with wire handles.
- 3.9 Localised heating device, such as a heat and strip gun.
- 3.10 Thermometer, a partial or total immersion thermometer or other suitable temperature measuring device with a temperature range of at least  $0 - 40^\circ\text{C}$  and graduated to  $1^\circ\text{C}$  or less with an uncertainty of no more than  $0.5^\circ\text{C}$ .
- 3.11 Stirrers, two suitable metal stirring rods or spatulas.
- 3.12 Sieve, 4.75 mm sieve conforming to ISO 3310.

### 4 Materials

The following materials are required:

- 4.1 Cloth, suitable absorbent lintless cloth.

## 5 Sample preparation

The sample shall be prepared as follows:

- 5.1 Prepare the bulk sample in accordance with Section 4 of Test Method Q101 to produce a representative subsample of appropriate size.
- 5.2 Further prepare the material by screening the subsample on a 4.75 mm sieve in accordance with Test Method Q101, Subsection 5.3 for coarse test fractions to produce four test fractions of approximately 1500 g. Discard any material passing the 4.75 mm sieve.

## 6 Bulk particle density

The following procedure shall be performed on two aggregate test fractions:

- 6.1 Immerse the aggregate test fraction in water for at least 24 hours.
- 6.2 Remove the aggregate from soaking and place the aggregate one particle deep on a dry cloth.
- 6.3 Roll and wipe the particles until all visible films of water have been removed but the surfaces of the aggregate still appear damp (Note 10.1).
- 6.4 Determine the mass of the saturated surface-dry test portion ( $m_2$ ).
- 6.5 Place the container directly below the hole in the balance bench and fill it until water escapes from the overflow.
- 6.6 Attach the basket to the balance so that it is completely immersed in water and determine the mass of the immersed basket ( $m_3$ ).
- 6.7 Transfer the test portion to the basket and agitate the aggregate particles to remove any entrapped air.
- 6.8 Determine the mass of the immersed aggregate and basket ( $m_4$ ).
- 6.9 Measure the temperature of the water in the container to the nearest 1°C.
- 6.10 Remove the aggregate from the basket and dry to a constant mass in the drying oven.
- 6.11 Determine the dry mass of the aggregate ( $m_1$ ).

## 7 Binder absorption

The following procedure shall be performed on two aggregate test fractions:

- 7.1 Place the aggregate test fraction in the drying oven and dry to a constant mass.
- 7.2 Heat the binder in the test oven until it is sufficiently fluid to pour then pour approximately 1500 g binder into a sample container.
- 7.3 Place a stirring rod in the sample container and stir the binder to remove entrapped air. Remove any bubbles remaining on the surface of the binder using the localised heating device.
- 7.4 Allow the sample container to cool to room temperature in a dust free environment. Determine the mass of the sample container, binder and stirring rod ( $m_5$ ).
- 7.5 Suspend the sample container from the balance and completely immerse it in the water container. Determine the mass of the immersed sample container, binder and stirring rod ( $m_6$ ) (Note 10.2).
- 7.6 Measure the temperature of the water in the container to the nearest 1°C.



- 7.7 Dry the sample container using the lintless cloth and then place it in the test oven for four hours together with the aggregate test fraction prepared in Step 7.1.
- 7.8 Remove the sample container and aggregate test fraction from the oven. Carefully add the aggregate to the binder in the sample container with constant stirring, avoiding any loss of binder or aggregate.
- 7.9 Stir the mix for about 30 seconds using a circular stirring motion. Apply a localised heating device to the surface of the binder to remove any air bubbles.
- 7.10 Stir the mix progressively around the circumference of the sample container using a digging stirring motion. This involves moving the end of the stirring rod from a point of contact between the top surface of the binder and container wall, down the inside wall of the container, and along the base of the container towards its centre. Pull the stirring rod back through the binder, retracing the same path but without being fully removed from the sample (Note 10.3).
- 7.11 Apply a localised heating device to the surface of the binder to remove any air bubbles.
- 7.12 Repeat Steps 7.10 and 7.11 until no more than three air bubbles appear within 10 seconds of the completion of the stirring cycle.
- 7.13 Allow the sample container to cool to room temperature in a dust free environment. Determine the mass of the sample container, binder, stirring rod and aggregate ( $m_7$ ).
- 7.14 Suspend the sample container from the balance and completely immerse it in the water container. Determine the mass of the immersed sample container, binder, stirring rod and aggregate ( $m_8$ ) (Note 10.2).
- 7.15 Measure the temperature of the water in the container to the nearest 1°C.

## 8 Calculations

Calculations shall be as follows:

### 8.1 Particle density

- 8.1.1 Calculate the particle density on a dry basis for each of the two test fractions as follows:

$$\rho_D = \frac{m_1 \rho_w}{m_2 - (m_4 - m_3)}$$

- where
- $\rho_D$  = test fraction particle density on a dry basis ( $t/m^3$ )
  - $m_1$  = mass of dry aggregate (g)
  - $\rho_w$  = density of the water at test temperature ( $t/m^3$ ) (Table 1)
  - $m_2$  = mass of saturated surface-dry aggregate (g)
  - $m_4$  = mass of immersed basket and aggregate (g)
  - $m_3$  = mass of immersed basket (g)

- 8.2 Provided the results from the two test fractions do not differ by more than 0.030  $t/m^3$ , calculate the mean result as the sample particle density ( $\rho_D$ ).

### 8.3 Binder absorption

8.3.1 Calculate the binder absorption for each of the two test fractions as follows:

$$b = 100\rho_B \left( \frac{1}{\rho_D} + \frac{m_5 - m_6}{(m_7 - m_5)\rho_1} - \frac{(m_7 - m_8)}{(m_7 - m_5)\rho_2} \right)$$

where	$b$	=	binder absorption (%)
	$\rho_B$	=	density of binder (t/m <sup>3</sup> ) (Note 10.4)
	$\rho_D$	=	sample particle density on a dry basis (t/m <sup>3</sup> )
	$m_5$	=	mass of container, binder and stirring rod (g)
	$m_6$	=	mass of immersed container, binder and stirring rod (g)
	$m_7$	=	mass of container, binder, stirring rod and aggregate (g)
	$\rho_1$	=	density of the water at test temperature for $m_6$ (t/m <sup>3</sup> ) (Table 1)
	$m_8$	=	mass of immersed container, binder, stirring rod and aggregate (g)
	$\rho_2$	=	density of the water at test temperature for $m_8$ (t/m <sup>3</sup> ) (Table 1)

8.4 Provided the results from the two test fractions do not differ by more than 0.15 %, calculate the mean result as the sample binder absorption.

## 9 Reporting

The following shall be reported:

9.1 Binder absorption to the nearest 0.05 %, and

9.2 The number of this Test Method, that is Q211.

## 10 Notes on method

10.1 Use a gentle current of air to accelerate drying but take care to avoid over-drying.

10.2 Prior to weighing, check the water container is filled to the overflow.

10.3 As the binder cools, the viscosity of the mix will increase. To avoid entrapment of air, slow the stirring of the mix.

10.4 If unknown, the binder density may be determined using Test Method AS 2341.7.

**Table 1 – Water density**

Test temperature (°C)	Water density (t/m <sup>3</sup> )	Test temperature (°C)	Water density (t/m <sup>3</sup> )
1	1.000	21	0.998
2	1.000	22	0.998
3	1.000	23	0.998
4	1.000	24	0.997
5	1.000	25	0.997
6	1.000	26	0.997
7	1.000	27	0.997
8	1.000	28	0.996
9	1.000	29	0.996

<b>Test temperature (°C)</b>	<b>Water density (t/m<sup>3</sup>)</b>	<b>Test temperature (°C)</b>	<b>Water density (t/m<sup>3</sup>)</b>
10	1.000	30	0.996
11	1.000	31	0.995
12	1.000	32	0.995
13	0.999	33	0.995
14	0.999	34	0.994
15	0.999	35	0.994
16	0.999	36	0.994
17	0.999	37	0.993
18	0.999	38	0.993
19	0.998	39	0.993
20	0.998	40	0.992

## Test Method Q212B: Binder stripping value - modified plate

### 1 Source

This Test Method was developed in-house and applies the principles of AS 1141.50 - 1998: *Resistance to stripping of cover aggregates from binders*.

### 2 Scope

This Test Method determines the resistance to stripping of a bituminous binder from aggregate using a modified plate stripping test. It provides a more rapid estimate of binder stripping potential than that achieved using AS 1141.50. Exclusive use of either Test Method Q212B or AS 1141.50 should be made for any series of tests.

The test procedure may be varied to allow for testing with binder containing anti-stripping agents or precoated aggregates.

### 3 Apparatus

The following apparatus is required:

- 3.1 Test plates, metal plates of 150 mm diameter with raised edges (for example, press-on lids from 4 litre containers).
- 3.2 Balance of suitable capacity, having a resolution of at least 0.01 g and a limit of performance within the range of  $\pm 0.05$  g.
- 3.3 Oven of suitable capacity, capable of heating a sample of binder to a temperature of 135-140°C.
- 3.4 Oven of suitable capacity, thermostatically controlled at a temperature of  $60 \pm 3^\circ\text{C}$ .
- 3.5 Water bath, thermostatically controlled at a temperature of  $50 \pm 1^\circ\text{C}$ .
- 3.6 Fan, an electric fan to assist in air drying aggregate samples.
- 3.7 Pliers, suitable for extracting aggregate pieces from a bituminous binder.

### 4 Materials

The following materials are required (Note 9.1):

- 4.1 Bituminous binder, where there is no requirement for the class of binder to be used in the test, use Class 170 bitumen conforming to AS 2008 *Bitumen for pavements* or Technical Specification MRTS 17 *Bitumen and Multigrade Bitumen*.
- 4.2 Cloth, suitable for cleaning test plates.
- 4.3 Mineral turpentine.
- 4.4 Acetone.

### 5 Preparation of test materials

The test materials shall be prepared as follows:

#### 5.1 Aggregates

Aggregate may be tested as received and or air dried in either the precoated or uncoated condition.

- 5.1.1 For aggregate to be tested in the as received condition, obtain a representative subsample which includes approximately 1 kg of the dominant particle size and seal it in an airtight container.
- 5.1.2 For aggregate to be tested in the air-dried condition, obtain a representative subsample which includes approximately 1 kg of the dominant particle size. Spread the aggregate subsample in a single layer in an oven tray and air dry overnight (alternatively the tray can be placed in front of a fan to expedite the drying process).

## 5.2 Binder

Heat about 200 g of the binder in the 135-140°C oven until it reaches pouring consistency.

## 5.3 Test plates

Remove any oil film or residue from the test plates, by cleaning each plate thoroughly with a cloth saturated in mineral turpentine, then rinse with acetone and allow to dry in a dust free environment.

## 6 Procedure

The procedure shall be as follows:

- 6.1 Pour 23.5 to 27.5 g portions of the binder onto each of two test plates, ensuring an even distribution of binder (Note 9.2).
- 6.2 Allow the prepared test plates to cool to room temperature in a dust free area.
- 6.3 Select 50 representative pieces of the dominant size fraction of the aggregate.
- 6.4 Firmly press 25 aggregate pieces into the binder layer in each of the two test plates.
- 6.5 Place the test plates in the 60°C oven for 1 hour, and then transfer to the water bath for 4 hours.
- 6.6 Remove the test plates from the water bath and immerse in water at room temperature for 30 minutes.
- 6.7 Remove one of the test plates from the water.
- 6.8 Extract an aggregate piece from the binder by hand or using the pliers as follows (Note 9.3):
  - 6.8.1 Extract the aggregate piece evenly with a direct upward pull and without any twisting or shoving motion.
  - 6.8.2 Where only collar or edge adhesion has taken place, ensure that the binder retained at the edge of the aggregate piece does not contact or overlay its underside before assessment of stripping is made.
- 6.9 Examine the underside of the aggregate piece and note the amount of binder adhering to it. Record it in one of the following categories:
  - a) completely stripped ( $N_c$ ): <10 percent binder adhering
  - b) partly stripped ( $N_p$ ): 10-90 percent binder adhering, and
  - c) no stripping: >90 percent binder adhering.
- 6.10 Repeat Steps 6.8 and 6.9 for the remaining aggregate pieces.
- 6.11 Repeat Steps 6.7 to 6.9 for the second test plate.

## 7 Calculations

Calculations shall be as follows:

- 7.1 For each test plate, count the number of aggregate pieces in each category.
- 7.2 Calculate the stripping value for each test plate as follows:

$$S_p = 4N_c + 2N_p$$

where  $S_p$  = Plate stripping value (%)  
 $N_c$  = Number of aggregate pieces completely stripped  
 $N_p$  = Number of aggregate pieces partly stripped

- 7.3 Provided the difference between the two plate stripping values is no greater than 10, mean the two values and record this mean as the binder stripping value (Note 9.4).

## 8 Reporting

The following shall be reported:

- 8.1 Aggregate description including source and size fraction tested.
- 8.2 Binder description including source, type and class.
- 8.3 Test condition (as received or air dried).
- 8.4 Binder stripping value to the nearest 1%, and
- 8.5 The number of this Test Method, that is Q212B.

## 9 Notes on method

- 9.1 Before handling bituminous binder, mineral turpentine or acetone, the operator should consult the relevant SDS.
- 9.2 If necessary, the test plates may be placed in the oven for a short time to attain an even binder film distribution.
- 9.3 Where adhesion is such that the aggregate piece cannot be extracted by hand or using the pliers, careful upward levering of the aggregate piece using a screwdriver or similar may be used.
- 9.4 If the difference is greater than 10, repeat the test. However, if the aggregate composition is highly variable, report the individual plate stripping values.

## Test Method Q212C: Binder stripping value - immersion tray

### 1 Source

This Test Method was developed in-house and applies the principles of AS 1141.50-1998: *Resistance to stripping of cover aggregate from binders*.

### 2 Scope

This Test Method describes the procedure for determining the resistance to stripping of binder from aggregate using the immersion tray test. It is applicable to the assessment of the adhesion promoting properties of bitumen anti-stripping agents.

### 3 Apparatus

The following apparatus is required:

- 3.1 Test plates, metal plates of 150 mm diameter with raised edges (for example, press-on lids from 4 litre containers).
- 3.2 Balance, of suitable capacity, having a resolution of at least 0.01 g and a limit of performance within the range of  $\pm 0.05$  g.
- 3.3 Drying oven of suitable capacity, having a temperature of 105 - 110°C and conforming to AS 1289.0.
- 3.4 Oven of suitable capacity, capable of heating a sample of binder to a temperature of 135 - 140°C.
- 3.5 Water bath, thermostatically controlled at a temperature of  $40 \pm 1^\circ\text{C}$ .
- 3.6 Sample container, a metal container of approximately 70 mm diameter and 250 mL volume.
- 3.7 Hotplate.
- 3.8 Pliers, suitable for extracting aggregate pieces from a bituminous binder.

### 4 Materials

The following materials are required (Note 9.1):

- 4.1 Aggregate, selected aggregate of 20 mm nominal size.
- 4.2 Bituminous binder, Class 170 bitumen conforming to AS 2008 *Bitumen for pavements* or Technical Specification MRTS17 *Bitumen and Multigrade Bitumen*, or other binder as specified.
- 4.3 Cutter, bitumen cutter oil conforming to Technical Specification MRTS19 *Cutter Oils*.
- 4.4 Cloth, suitable for cleaning test plates.
- 4.5 Mineral turpentine.
- 4.6 Acetone.

## 5 Preparation of test materials

The test materials shall be prepared as follows:

### 5.1 Aggregates

Select 30 representative pieces of the dominant size fraction of the aggregate. Wash, then oven dry at 105 - 110°C.

### 5.2 Binder

Heat about 200 g of the binder in the 135-140°C oven until it reaches pouring consistency.

### 5.3 Test plates

Remove any oil or residue from the test plates by cleaning each plate thoroughly with a cloth saturated in mineral turpentine, then rinse with acetone and allow to dry in a dust free environment.

## 6 Procedure

The procedure shall be as follows:

- 6.1 Weigh into the sample container, the mass of anti-stripping agent required to produce the targeted anti-stripping agent concentration in 100 to 140 g binder, to the nearest 0.01 g.
- 6.2 Weigh into the sample container the mass of binder needed to produce the required anti-stripping agent concentration, to the nearest 1 g.
- 6.3 Transfer the sample container and contents to the hotplate and heat gently. Stir vigorously with a glass stirring rod for about 5 minutes.
- 6.1 Calculate the mass of cutter required to produce a cutter content of 7.5 percent by volume, to the nearest 0.1 g as follows:

$$M_C = \frac{7.5D_C M_B}{D_B}$$

where  $M_C$  = mass of cutter (g)  
 $D_B$  = density of binder (t/m<sup>3</sup>)  
 $D_C$  = density of cutter (t/m<sup>3</sup>)  
 $M_B$  = mass of binder (g)

- 6.2 Add to the sample container the mass of cutter calculated in Step 6.4 and stir the contents vigorously to achieve complete solution (Note 9.2).
- 6.3 Check weigh the mass of the sample container and contents and add further cutter to compensate for any cutter loss during the heating and mixing process.
- 6.4 Combine repeated additions of cutter with continuous stirring until the required mass of cutter in the sample is obtained to the nearest 0.1 g (Note 9.3).
- 6.5 Pour 23.5 – 27.5 g portions of the prepared sample onto each of three test plates and spread the sample on each test plate as quickly as possible to form a continuous and even film distribution over the plate (Note 9.4).
- 6.6 Allow the three test plates to cool to room temperature in a dust free area and then immerse to a depth of at least 25 mm in the water bath for at least 20 minutes.



- 6.7 Select one of the test plates and firmly press 10 pieces of aggregate into the binder in the test plate while the plate remains immersed in the water bath. After a further 10 to 12 minutes of immersion, remove the test plate from the water bath.
- 6.8 Extract an aggregate piece from the binder by hand or using the pliers as follows (Note 9.5):
  - 6.8.1 Extract the aggregate piece evenly, with a direct upward pull without any twisting or shoving motion.
  - 6.8.2 Where only collar or edge adhesion has taken place, ensure that the binder retained at the edge of the aggregate piece does not contact or overlay its underside before assessment of stripping is made.
- 6.9 Examine the underside of the aggregate piece and note the amount of binder adhering to it.
- 6.10 Rate the quantity of binder adhering on a scale of 0 to 10, with 10 being full cover.
- 6.11 Repeat Steps 6.11 to 6.13 for each of the remaining aggregate pieces.
- 6.12 Sum the ratings for all 10 aggregate pieces and record the total as the binder adhesion in percent.
- 6.13 Repeat Steps 6.10 to 6.15 for the remaining two test plates (Notes 9.6 and 9.7).

## **7 Calculations**

Calculations shall be as follows:

- 7.1 Calculate the stripping result for each test plate by subtracting the binder adhesion result from 100.
- 7.2 If the difference between the stripping results of the three test plates is less than 20 %, calculate the mean of the three results and record it as the stripping value.
- 7.3 If the difference between the stripping results of the three test plates exceeds 20 % but two of the results agree within 10 %, calculate the mean of these two results and record it as the stripping value.
- 7.4 If the difference between the stripping results of the three test plates exceeds 20 % and no two results agree within 10 %, repeat the test.

## **8 Reporting**

The following shall be reported:

- 8.1 Stripping value to the nearest 1 %, and
- 8.2 The number of this Test Method, that is Q212C.

## **9 Notes on method**

- 9.1 Before handling bituminous binder, mineral turpentine, acetone or cutter, the operator should consult the relevant SDS.
- 9.2 If the contents have cooled so that thorough mixing is difficult, gentle warming of the contents is permitted.
- 9.3 It is important that the correct quantity of cutter is added to the binder. Varying quantities of cutter will lead to varying binder viscosities which have considerable influence on the stripping value obtained.

- 9.4 If the sample on the test plate has cooled so that spreading of the sample to form a continuous film over the test plate is difficult, minimal warming of the test plate in the oven is permitted. However, under no circumstances should a hotplate be used for this purpose.
- 9.5 Where adhesion is such that the aggregate piece cannot be extracted by hand or using the pliers, careful upward levering of the aggregate piece using a screwdriver or similar may be used.
- 9.6 Alternatively, Steps 6.10 to 6.15 for the three test plates may be performed in parallel.
- 9.7 Where the stripping value for more than one aggregate type is required, the test plate may be returned to the water bath for 20 minutes and then reused for Steps 6.10 to 6.15. However, avoid those areas previously occupied on the binder surface by aggregate pieces. In this way, the test plate may be used for up to three aggregate types.

## Test Method Q216: Degree of aggregate precoating

### 1 Source

This Test Method was developed in-house using techniques evolved through internal departmental research investigations.

### 2 Scope

This Test Method describes a procedure for the visual assessment of the percentage of aggregate surface covered by a precoating agent. It is applicable to aggregate retained on the 4.75 mm sieve.

### 3 Apparatus

Example of sample divider (riffle) is contained in AS 1141.2 Figure 1.

The following apparatus is required:

- 3.1 Sieve, 4.75 mm, conforming to ISO 3310.
- 3.2 Drying oven of suitable capacity, having a temperature of 45-50°C and conforming to AS 1141.2.
- 3.3 Container of suitable size, for drying the test portion.
- 3.4 Sample dividers (riffle), conforming to the requirements of AS 1141.2.
- 3.5 Cone and quartering equipment such as flat-bottomed scoop or trowel and brush.
- 3.6 Suitable gloves, for handling the precoated aggregate (Note 7.1).

### 4 Procedure

The procedure shall be as follows:

- 4.1 Prepare the bulk sample in accordance with Section 4 of Test Method Q101 to produce a representative subsample of appropriate size.
- 4.2 Further prepare the sample by screening on a 4.75 mm sieve to produce sufficient unwashed and oven dried at 45 - 50°C materials to produce a subsample in accordance with Test Method Q101, Subsection 5.3 for coarse fraction subsamples.
- 4.3 Using either a sample divider or by cone and quartering, obtain a test portion from the material retained on 4.75 mm sieve, of at least 100 particles.
- 4.4 Spread the test portion on a clean flat surface of sufficient area to permit easy inspection.
- 4.5 Assess the proportion of the surface area of each particle covered by the precoating agent to the nearest 10 percentage units ( $a_i$ ) and separate into groups of particles with the same proportion of the surface area covered by the precoating agent. At the end of the assessment and separation process there should be small groups of particles with assessed proportions of the surface area covered by the precoating agent from 0 to 100% in intervals of 10%.
- 4.6 Retain the particles and determine the number of particles in each group ( $n_i$ ) and the number of particles in the test portion ( $\sum n_i$ ).

## 5 Calculations

Calculations shall be as follows:

- 5.1 Calculate the degree of aggregate precoating as follows:

$$P_{pc} = \frac{\sum a_i n_i}{\sum n_i}$$

- where
- |          |   |   |
|----------|---|---|
| $P_{pc}$ | = | degree of aggregate precoating (%)  |
| $a_i$    | = | percentage of surface area of each group of particles covered by precoating agent |
| $n_i$    | = | number of particles in each group of particles                                    |

## 6 Reporting

The following shall be reported:

- 6.1 Degree of aggregate precoating to the nearest 1%, and  
6.2 The number of this Test Method, that is Q216.

## 7 Notes on method

- 7.1 Before handling the precoated aggregate, the operator should consult the relevant SDS for the precoating agent used.

## Test Method Q227: Pull-out force for surfacing aggregate

### 1 Source

This Test Method has been adapted from one of the techniques described from a similar test published in the 1994 South African *Sabita Manual: Technical Guidelines for Seals using Homogeneous Modified Binders*.

### 2 Scope

This Test Method provides for the determination of an average pull-out force required to dislodge cover aggregate pieces from a bituminous binder on a sprayed seal to assess the level of bonding of the aggregate to the binder surface. Data on pull-out force could prove useful in general sealing work in indicating the degree of early trafficking control required on freshly laid seals.

### 3 Apparatus

The following apparatus is required:

- 3.1 Spring balance, having a capacity of 1000 g, with a resolution of at least 10 g, fitted with a zeroing adjustment (Notes 8.1 and 8.2).
- 3.2 Crocodile clip, 50 mm in length, with maximum stiffness in grip and with an attached wire or string line, approximately 0.5 m long.
- 3.3 Infrared thermometer, with a resolution of at least 0.2°C, over the range from 10°C to 80°C.
- 3.4 Safety glasses.

### 4 Preparation for testing

Prepare for testing as follows:

- 4.1 Select at least twelve test positions of approximately equal spacing along a length of seal of essentially homogeneous condition (Note 8.3).
- 4.2 Connect the crocodile clip to the spring balance by the attached line.
- 4.3 Hold the spring balance such that the zero point of the spring balance scale is at about eye level (Note 8.4).
- 4.4 Attach the crocodile clip to an individual loose stone of a size representative of that to be tested, zero the spring balance and discard the stone.

### 5 Procedure

The procedure shall be performed as follows at each test position

- 5.1 Measure and record the surface temperature ( $T$ ) to the nearest 0.2°C using the infrared thermometer.
- 5.2 Select a typically bound stone from each test position and attach the crocodile clip to the stone. The stone selected should be of suitable shape to permit effective gripping of the clip.
- 5.3 Wearing the safety glasses, slowly raise the upper portion of the balance using a smooth action to apply a pull-out rate of about 20 g/second. Monitor the scale carefully and continue the load application until the stone becomes detached (Note 8.5).
- 5.4 Record the maximum force reading as the pull out force ( $f_1$ ).

- 5.5 Estimate the amount of embedment into the binder of the detached stone by the height of binder on the stone and record this value as a percentage of the height of the stone. For this purpose, record a value of 50% for a stone half embedded in the binder and a value of 10% if only the complete base of the stone is coated with binder (Note 8.6).

## 6 Calculations

Calculations shall be as follows:

- 6.1 Apply a temperature correction factor to the pull-out force recorded at each test position to correct the pull-out force to 40°C as follows (Note 8.7):

$$\log f_2 = \log f_1 - 0.05(40 - T)$$

where  $f_2$  = pull-out force (g) corrected to 40°C  
 $f_1$  = pull-out force (g)  
T = surface temperature (°C)

- 6.2 Examine the values of log pull-out force corrected to 40°C for all test positions and eliminate any values which are extraordinarily high or low in comparison to the remaining values within the data set.
- 6.3 Calculate the mean of the remaining values of the log pull-out force and take the antilog of this mean value to determine the typical pull-out force over the site.
- 6.4 Determine the mean height of binder on the stones used to determine the typical pull-out force over the site.

## 7 Reporting

The following shall be reported:

- 7.1 Typical pull-out force to the nearest 10 g.
- 7.2 Mean height of binder to the nearest 1%.
- 7.3 The number of this Test Method, that is Q227.

## 8 Notes on method

- 8.1 A Kern Model No. 41000 is regarded as a suitable spring balance.
- 8.2 When field conditions provide pull-out forces generally above 1000 g, for example, cooler temperatures, large or strongly interlocked aggregate pieces, tough binders and so on, an alternative spring balance of higher force capacity will be required.
- 8.3 The general location of each test position may be determined by pacing the appropriate distance.
- 8.4 The tester will normally carry out testing in either a sitting or squatting position.
- 8.5 If the stone twists during the test to cause a significantly reduced pull-out force, the result should be discarded, and another stone tested from the same general area of the test position.
- 8.6 In many instances, the stone is not embedded evenly within the binder and, for such cases, the recorded height is an estimated mean around all sides of the stone.
- 8.7 The temperature correction factor of -0.05 used relates to conventional binders.

## Test Method Q228: Mill abrasion of aggregate

### 1 Source

This Test Method is based on a test procedure described in Canadian Pacific Ltd (1981) *CP Rail specification for evaluating processed rock, slag and gravel ballasts (Appendix A)*, Canadian Pacific Ltd, Montreal, Canada. It differs from this procedure in only minor procedural variations.

### 2 Scope

This Test Method describes the procedure for determining the mill abrasion value of coarse aggregates using a wet attrition technique. If required, the method also allows the calculation of an abrasion number using the mill abrasion value and the Los Angeles value.

### 3 Apparatus

Where appropriate, the working tolerances of apparatus are contained in Table 1

The following apparatus is required:

- 3.1 Drying oven of suitable capacity, having a temperature of 105 - 110°C and conforming to AS 1141.2.
- 3.2 Wire brush.
- 3.3 Scalping screen, a 9.50 mm sieve is suitable.
- 3.4 Sieves:
  - a) 37.5 mm, 26.5 mm, 19.0 mm and 4.75 mm as required, conforming to ISO 3310.
  - b) Reinforced 0.075 mm sieve of 300 mm diameter and conforming to ISO 3310
- 3.5 Balance, of suitable capacity, having a resolution of at least of 1 g and a limit of performance within the range of  $\pm 5$  g.
- 3.6 Measuring cylinder, glass measuring cylinder of 1000 mL capacity.
- 3.7 Mill abrasion apparatus:
  - a) Motorised tumbler, capable of revolving the porcelain jar about its longitudinal axis at 33 revolutions per minute for a total of 10,000 revolutions, and
  - b) Porcelain jar, 5 litre capacity, fitted with a lid to hold water and have an external diameter of 230 mm.

Before using the porcelain jar for the first time, condition the porcelain jar by running the apparatus with 500 g of silica sand and 0.75 litres of distilled water for 1 to 5 hours. When a porcelain jar has lost approximately 35% of its initial mass, it should not be used for further testing.
- 3.8 Containers suitable for washing test fractions.
- 3.9 Washing sink, with flexible water line, spray nozzle and adjustable flow to deliver water for washing and transfer of sample. A silt trap may be required to prevent blocking of drains.
- 3.10 Oven tray.

## 4 Materials

The following material is required:

- 4.1 Distilled water.

## 5 Sample preparation

The sample shall be prepared as follows:

- 5.1 Prepare the bulk sample in accordance with Section 4 of Test Method Q101 to produce a representative subsample of appropriate size.
- 5.2 Further prepare the material by screening the subsample on a 19.0 mm sieve in accordance with Test Method Q101, Subsection 5.3 for coarse test fractions to produce a test fraction of approximately 30 kg oven dried at 105-110°C. Discard any material passing the 19.0 mm sieve.
- 5.3 Using the wire brush to remove any adhering fines or soft weathered rock.
- 5.4 Crush the test fraction in accordance with Test Method Q101D Subsection 5, using a jaw crusher, as follows:
  - a) gradually reduce the maximum particle size to 50 mm
  - b) sieve the crushed material over the scalping screen and discard any material passing the screen
  - c) if the material retained on the scalping screen is not homogenous, remove and discard any particles which are at variance with the bulk of the sample (Note 9.1), and
  - d) Further crush the retained material, gradually reducing its size until nearly all material passes the 37.5 mm sieve and a range of particle sizes in keeping with the requirements of Table 2 is produced.
- 5.5 Prepare the crushed material to produce sufficient washed and oven dried at 105 - 110°C materials of the size and quantity specified in Table 2 in accordance with Test Method Q101, Subsection 5.5 for specified test fractions (Note 9.2).
- 5.6 Combine the two fractions to produce the test portion and determine the mass of the test portion ( $m_1$ ).

## 6 Procedure

The procedure shall be as follows:

- 6.1 Place the test portion in the porcelain jar, together with 3 litres of distilled water.
- 6.2 Place the lid on the porcelain jar and secure the assembly in the tumbler.
- 6.3 Operate the tumbler for 10,000 revolutions.
- 6.4 Decant the wash water from the porcelain jar into the nested 4.75 mm and 0.075 mm sieves.
- 6.5 Remove the larger particles from the jar by hand and place on the 4.75 mm sieve.
- 6.6 Wash out the jar with water and continue to wash the particles with the wash water from the jar until the water from the jar is clear.
- 6.7 Continue washing the particles on each sieve until the wash water passing the 0.075 mm sieve is clear.



- 6.8 Place the washed material into a drying tray and dry the material retained on the 0.075 mm sieve until a constant mass is reached and record the dry mass ( $m_2$ ).

## 7 Calculations

Calculations shall be as follows

- 7.1 Calculate the mill abrasion value as follows:

$$MA = \frac{m_1 - m_2}{m_1} 100$$

where  $MA$  = Mill Abrasion value  
 $m_1$  = original washed and dried test portion (g)  
 $m_2$  = dried sample retained 0.075 mm (g)

- 7.2 If required, calculate the Abrasion Number using the results from the Los Angeles Test and the Mill Abrasion Test as follows:

$$AN = LAA + (5MA)$$

where  $AN$  = Abrasion Number  
 $LAA$  = Los Angeles Abrasion value (from Test Method AS 1141.23)  
 $MA$  = Mill Abrasion value

## 8 Reporting

The following shall be reported:

- 8.1 Report the Mill Abrasion value to the nearest 0.1.  
 8.2 Report the Abrasion Number to the nearest whole number, if required, and  
 8.3 The number of this Test Method, that is Q228.

## 9 Notes on method

- 9.1 The scalping process is intended to simulate the anticipated quarry practice by removing from the sample such material which would not be representative of the quarried product. The aperture of the scalping screen should be selected on this basis.  
 9.2 Some discrete rock particles will slowly break down when agitated in water. This is evidenced by discolouration of the wash water. In such cases, discontinue washing after all coatings of fines have been removed.

**Table 1 – Working tolerances for apparatus**

Apparatus	Value	Tolerance
<b>Mill abrasion tumbler</b>		
Speed (rpm)	33	± 2
<b>Porcelain Jar</b>		
External diameter (mm)	230	± 10
Volume (L)	5	nominal

**Table 2 – Mass of fractions required for test portion**

<b>Particle size (mm)</b>	<b>Mass of fraction (g)</b>
37.5 – 26.5	1500 ± 15
26.5 – 19.0	1500 ± 15

## Test Method Q229A: Resistance to degradation by abrasion of fine aggregate

### 1 Source

This Test Method is based on a Test Method ASTM D7428: *Resistance of fine aggregate to degradation by abrasion in the Micro-Deval apparatus*. It differs from this procedure in the sizing of test fraction, not using a reference aggregate, performing the test in duplicate and other minor procedural variations.

### 2 Scope

This Test Method describes the procedure for determining the resistance to abrasion of fine aggregate using a wet attrition technique. The Test Method uses a combination of abrasion and grinding with steel balls in the presence of water using a Micro-Deval apparatus.

### 3 Apparatus

Where appropriate, the working tolerances of apparatus are contained in Table 1. Examples of the apparatus are shown in ASTM D 6928 Figure 1.

The following apparatus is required:

- 3.1 Drying oven of suitable capacity, having a temperature of 105 - 110°C and conforming to AS 1141.2.
- 3.2 Sieves:
  - a) 4.75 mm, 2.36 mm, 1.18 mm, 0.600 mm, 0.300 mm, 0.150 and 0.075 mm as required, conforming to ISO 3310.
  - b) Reinforced 0.075 mm sieve conforming to ISO 3310 (Note 9.1).
- 3.3 Balance of suitable capacity, having a resolution of at least of 0.1 g and a limit of performance within the range of  $\pm 0.5$  g.
- 3.4 Measuring cylinder of suitable capacity with graduations no larger than 50 mL.
- 3.5 Micro-Deval apparatus:
  - a) Micro-Deval abrasion machine capable of revolving a 5 litre abrasion jar about its longitudinal axis at 100 revolutions per minute for a total of 1,500 revolutions
  - b) Abrasion jar, stainless steel of 5 L capacity fitted with a lid to hold water, an external diameter of 198 mm and an internal height of 173.5 mm. The inside and outside surfaces need to be smooth and have no observable ridges or indentations, and
  - c) Abrasion charge consisting of stainless steel ball of 9.5 mm diameter and with sufficient numbers for a 1250 g charge for each jar.

Before using the abrasion jar and charge for the first time, condition the abrasion jar and charge by running the apparatus with 500 g of silica sand and 0.75 litres of distilled water for four hours. It may be necessary from time to time to re-condition the abrasion jar and charge. The conditioning process should give the abrasion jar and charge a “frosted” appearance.

- 3.6 Oven tray.

### 4 Materials

The following materials are required:

4.1 Distilled water.

4.2 Silica sand.

## 5 Sample preparation

The sample shall be prepared as follows:

- 5.1 Prepare the bulk sample in accordance with Section 4 of Test Method Q101 to produce two representative subsamples of appropriate size.
- 5.2 Further prepare each subsample to produce sufficient washed and oven dried at 105 - 110°C material to produce two test fractions of the size and quantity specified in Table 2 in accordance with Test Method Q101, Subsection 5.5 for specified test fractions (Note 9.2).
- 5.3 Allow the washed test fractions, from each subsample, to cool to room temperature then combine to produce two test portions.

## 6 Procedure

The procedure shall be as follows:

- 6.1 Determine the mass of the test portion ( $m_1$ ).
- 6.2 Place the test portion in the abrasion jar, together with  $0.75 \pm 0.05$  litres of distilled water.
- 6.3 Store the abrasion jar in an air-conditioned room at  $23 \pm 3^\circ\text{C}$  for at least 1 hour.
- 6.4 Add the mass of charge specified in Table 2 to the abrasion jar. Place the lid on the abrasion jar and place the abrasion jar in the abrasion machine.
- 6.5 Operate the machine for the appropriate number of revolutions specified in Table 2.
- 6.6 Remove the abrasion jar from the machine.
- 6.7 Decant the wash water from the abrasion jar into the nested 1.18 mm and 0.075 mm sieves.
- 6.8 Carefully pour the test portion and abrasion charge over the sieves. Wash out the jar with water until the water from the jar is clear. Take care to remove the entire test portion from the jar.
- 6.9 Continue washing and agitation of the particles with the wash water from the jar until the water from the jar is clear and all material smaller than 0.075 mm passes that sieve.
- 6.10 Remove the abrasion charge from the washed material.
- 6.11 Place washed material retained on the 1.18 mm and 0.075 mm sieves in a drying tray and dry the material until a constant mass is reached and record the dry mass ( $m_2$ ).
- 6.12 Repeat Steps 6.1 to 6.11 for the second test portion.

## 7 Calculations

Calculations shall be as follows:

- 7.1 Calculate the abrasion loss (fine) for each test portion as follows:

$$AL_f = \frac{m_1 - m_2}{m_1} 100$$

where  $AL_f$  = abrasion loss (fine) (%)  
 $m_1$  = original washed and dried test portion (g)

$$m_2 = \text{dried material retained } 0.075 \text{ mm (g)}$$

7.2 Calculate the abrasion loss (fine) as the mean abrasion loss of the two test portions.

## 8 Reporting

The following shall be reported:

8.1 Abrasion loss (fine) to the nearest 0.1%, and

8.2 The number of this Test Method, that is Q229A.

## 9 Notes on method

9.1 Because of the ease with which a 0.075 mm sieve can be damaged, the use of a special washing sieve, in which the sieve cloth is reinforced underneath with a coarser sieve or punched plate screen, is recommended.

9.2 Some discrete rock particles will slowly break down when agitated in water. This is evidenced by discolouration of the wash water. In such cases, discontinue washing after all coatings of fines have been removed.

**Table 1 – Working tolerances for apparatus**

Apparatus	Value	Tolerance
<b>Micro-Deval abrasion machine</b>		
Speed (rpm)	100	± 5
<b>Abrasion charge</b>		
Diameter (mm)	9.5	± 0.5
<b>Abrasion Jars</b>		
External diameter (mm)	198	± 4
Internal height (mm)	173.5	± 3.5
Volume (L)	5	nominal

**Table 2 – Mass of fractions, abrasion charge and revolutions required for test portion**

Maximum size (mm)	Fraction size (mm)	Mass of fraction (g)	Mass of charge (g)	Revolutions (rpm)
4.75	4.75 - 2.36	50 ± 0.5	1250 ± 5	1,500 ± 10
	2.36 – 1.18	125 ± 1		
	1.18 – 0.600	125 ± 1		
	0.600 – 0.300	100 ± 1		
	0.300 – 0.150	75 ± 1		
	0.150 – 0.075	25 ± 0.5		

## Test Method Q229B: Resistance to degradation by abrasion of coarse aggregate

### 1 Source

This Test Method is based on a Test Method AASHTO T327: *Resistance of coarse aggregate to degradation by abrasion in the Micro-Deval apparatus*. It differs from this procedure in the sizing of test fraction, not using a reference aggregate, performing the test in duplicate and other minor procedural variations.

### 2 Scope

This Test Method describes the procedure for determining the resistance to abrasion of coarse aggregate using a wet attrition technique. The Test method uses a combination of abrasion and grinding with steel balls in the presence of water using a Micro-Deval apparatus.

### 3 Apparatus

Where appropriate, the working tolerances of the apparatus are contained in Table 1. Examples of the apparatus are shown in ASTM D 6898 Figure 1.

The following apparatus is required:

- 3.1 Drying oven of suitable capacity, having a temperature of 105 - 110°C and conforming to AS 1141.2.
- 3.2 Sieves, 19.0 mm, 16.0 mm, 13.2 mm, 9.50 mm, 6.70 mm, 4.75 mm and 1.18 mm as required, conforming to ISO 3310.
- 3.3 Balance of suitable capacity, having a resolution of at least of 0.1 g and a limit of performance within the range of  $\pm 0.5$  g.
- 3.4 Measuring cylinder of suitable capacity with graduations no larger than 50 mL.
- 3.5 Micro-Deval apparatus:
  - a) Micro-Deval abrasion machine capable of revolving a 5 litre abrasion jar about its longitudinal axis at  $100 \pm 5$  revolutions per minute for a total of 9,500 to 12,000 revolutions.
  - b) Abrasion jar, stainless steel of 5 L capacity fitted with a lid to hold water, an external diameter of 198 mm and an internal height of 173.5 mm. The inside and outside surfaces need to be smooth and have no observable ridges or indentations.
  - c) Abrasion charge consisting of stainless-steel ball of 9.5 mm diameter and with sufficient numbers for a 5000 g charge for each jar.

Before using the abrasion jar and charge for the first time, condition the abrasion jar and charge by running the apparatus with 500 g of silica sand and 0.75 litres of distilled water for four hours. It may be necessary from time to time to re-condition the abrasion jar and charge. The conditioning process should give the abrasion jar and charge a “frosted” appearance.

- 3.6 Oven tray.

## 4 Materials

The following material is required:

- 4.1 Distilled water.

## 5 Sample preparation

The sample shall be prepared as follows:

- 5.1 Prepare the bulk sample in accordance with Section 4 of Test Method Q101 to produce two subsamples of appropriate size.
- 5.2 Further prepare each subsample to produce sufficient washed and oven dried at 105 - 110°C material to produce two test fractions of the size and quantity specified in Table 2 in accordance with Test Method Q101, Subsection 5.5 for specified test fractions (Note 9.1).
- 5.3 Allow the washed test fractions, from each subsample, to cool to room temperature then combine to produce two test portions.

## 6 Procedure

The procedure shall be as follows:

- 6.1 Determine the mass of the test portion ( $m_1$ ).
- 6.2 Place the test portion in the abrasion jar, together with  $2.00 \pm 0.05$  litres of distilled water.
- 6.3 Store the abrasion jar in an air-conditioned room at  $23 \pm 3^\circ\text{C}$  for at least 1 hour.
- 6.4 Add the mass of charge specified in Table 2 to the abrasion jar. Place the lid on the abrasion jar and place the abrasion jar in the abrasion machine.
- 6.5 Operate the machine for the appropriate number of revolutions specified in Table 2.
- 6.6 Remove the abrasion jar from the machine.
- 6.7 Decant the wash water from the abrasion jar into the nested 4.75 mm and 1.18 mm sieves.
- 6.8 Carefully pour the test portion and abrasion charge over the sieves. Wash out the jar with water until the water from the jar is clear. Take care to remove the entire test portion from the jar.
- 6.9 Continue washing and agitation of the particles with the wash water from the jar until the water from the jar is clear and all material smaller than 1.18 mm passes that sieve.
- 6.10 Remove the abrasion charge from the washed material.
- 6.11 Place washed material retained on the 4.75 mm and 1.18 mm sieves in a drying tray and dry the material until a constant mass is reached and record the dry mass ( $m_2$ ).
- 6.12 Repeat Steps 6.1 to 6.11 for the second test portion.

## 7 Calculations

Calculations shall be as follows:

- 7.1 Calculate the abrasion loss (coarse) for each test portion as follows:

$$AL_c = \frac{m_1 - m_2}{m_1} 100$$

where  $AL_c$  = abrasion loss (coarse) (%)

$m_1$  = original washed and dried test portion (g)

$m_2$  = dried sample retained 1.18 mm (g)

7.2 Calculate the abrasion loss (coarse) as the mean abrasion loss (coarse) from the two test portions.

## 8 Reporting

The following shall be reported:

8.1 Abrasion loss (coarse) to the nearest 0.1%.

8.2 Maximum size of aggregate tested (mm), and

8.3 The number of this Test Method, that is Q229B.

## 9 Notes on method

9.1 Some discrete rock particles will slowly break down when agitated in water. This is evidenced by discolouration of the wash water. In such cases, discontinue washing after all coatings of fines have been removed.

**Table 1 – Working tolerances for apparatus**

Apparatus	Value	Tolerance
<b>Micro-Deval abrasion machine</b>		
Speed (rpm)	100	± 5
<b>Abrasion charge</b>		
Diameter (mm)	9.5	± 0.5
<b>Abrasion Jars</b>		
External diameter (mm)	198	± 4
Internal height (mm)	173.5	± 3.5
Volume (L)	5	nominal

**Table 2 – Mass of fractions, abrasion charge and revolutions required for test portion**

Maximum size (mm)	Fraction size (mm)	Mass of fraction (g)	Mass of charge (g)	Revolutions (rpm)
19.0	19.0 – 16.0	375 ± 1	5000 ± 5	12,000 ± 100
	16.0 – 13.2	375 ± 1		
	13.2 – 9.5	750 ± 3		
16.0	13.2 – 9.5	750 ± 3	5000 ± 5	10,500 ± 100
	9.5 – 6.7	375 ± 1		
	6.7 – 4.75	375 ± 1		
13.2	9.5 – 6.7	750 ± 3	5000 ± 5	9,500 ± 100
	6.7 – 4.75	750 ± 3		



## Test Method Q230: Particle size distribution and shape – rock

### 1 Source

This Test Method applies the principles of ASTM Test Method D5519: *Standard Test Method for Particle Size Analysis of Natural and Man-Made Riprap Materials* and AS 1141.14: *Particle shape by proportional calliper*.

### 2 Scope

This Test Method describes the procedure for taking samples of rock to be used for rock masonry, grouted rock pitching, rock protection, gabion rock, mattress protection, drainage blanket, spill through rock, rock fill and high permeability drainage layer to determine, in the field, the particle size distribution and if required the shape of the rock.

### 3 Definitions

For this Test Method, the following definitions shall apply:

- 3.1 Elongated rock – having a ratio of length to width greater than the calliper ratio adopted.
- 3.2 Flat rock – having a ratio of width to thickness greater than the calliper ratio adopted.
- 3.3 Flat and elongated rock – having a ratio of length to width and a ratio of width to thickness greater than the calliper ratio adopted.
- 3.4 Length, width and thickness – are, respectively, the greatest, intermediate and least dimensions of any rock, as measured along mutually perpendicular directions, that is, they are the principal dimensions of the circumscribing rectangular prism.
- 3.5 Non-cubical rock – having a ratio of length to thickness greater than the calliper ratio adopted.

### 4 Apparatus

Where appropriate, the working tolerances of the apparatus are contained in Tables 1 and 2.

The following apparatus is required:

- 4.1 Weighing device:
  - a) Platform balance of suitable capacity, with a readability and limit of performance of not less than the requirements of Table 1, or
  - b) Registered weighbridge of suitable capacity, with a verified scale interval (e) of at least 20 kg and a maximum permissible error (MPE) within the range of  $\pm 100$  kg.
- 4.2 Sieves and/or templates:
  - a) Single-opening templates made from steel rod, steel bar or similar rigid material, with square apertures of 600 mm, 500 mm, 400 mm, 350 mm, 300 mm, 250 mm, 200 mm, 150 mm and 125 mm. Add hand-grips or handles for ease of use. For larger size rock, it is useful to use C-shaped templates representing the sieve aperture and the diagonal of the sieve aperture. Refer to ASTM D5519 Figure 1 for an example of a single opening sieve template and a C-shaped template.
  - b) Sieves, perforated plate sieves, 120 mm, 100 mm, 75.0 mm, 50 mm, 26.5 mm, 19.0 mm, 2.36 mm, 1.18 mm and 0.075 mm conforming to ISO 3310-2.

- 4.3 Transport vehicle capable of conveying the individual or groups of the individual sorted rock from the sampling point to the test area and from the test area to the weighbridge.
- 4.4 Handling equipment such as forklift or loaders, or similar, for sampling, transporting, assisting in the sorting, loading for transport, weighing and other tasks associated with the test.
- 4.5 Tape measure for determining particle size dimensions to estimate mass.
- 4.6 Test area, sufficiently large to allow placement of the test sample, areas, bins or containers to place the sorted materials and adequate to allow the transport vehicle and handling equipment to operate safely. The test area should have a smooth surface, such as concrete, to prevent the loss of fines and provide a suitable working surface.
- 4.7 Proportional callipers, of suitable size with ratios of 2:1 and 3:1. Refer to ASTM D5519 Figure 1 for an example of a proportional calliper.
- 4.8 Containers suitable for holding and weighing finer fractions.
- 4.9 Spray paint for marking larger rock.
- 4.10 Tags and markers or small signs for identifying fractions.
- 4.11 Hand tools including crowbars, shovels and so on.
- 4.12 Gloves, glasses and dust masks.

## 5 Sampling

The sampling shall be performed as follows:

- 5.1 Taking into account the type of material to be sampled and the type and scope of testing, prepare a sampling plan to provide a representative sample of the material. The plan should be appropriate for existing conditions, available resources and requirements of the specification.
- 5.2 Using a tape measure estimate the maximum particle size within the material. Determine the minimum mass of sample from Table 1 or by calculation (Note 10.1).
  - 5.2.1 Determine the mass of the empty truck from a registered weighbridge ( $m_1$ ) or the mass of empty containers using a balance ( $m_1$ ).
  - 5.2.2 A single sample is taken for testing and placed in the transport vehicle or containers.
  - 5.2.3 Determine the mass of the truck and sample ( $m_2$ ) from a registered weighbridge or the mass of containers and sample using a balance ( $m_2$ ).

## 6 Procedure

The procedure shall be as follows:

### 6.1 Particle size distribution

- 6.1.1 To determine the sieves/templates required, it is necessary to consult any applicable specification for the material under test. The number of sieves/templates used should not be less than four.
- 6.1.2 Move the sample to the test location and for samples with rocks larger than 200 mm spread the sample in a thin layer.
- 6.1.3 Determine the mass of the truck/containers to be used for holding each fraction and record the mass ( $m_c$ )

- 6.1.4 Place each individual rock on a sieve or template to determine the sizes that the rock will pass and be retained on. Alternately the template may be placed over the rock to determine its size. If rock shape is being determined in accordance with Subsection 6.2, test each rock with the proportional calliper to determine if it is flat, elongated and flat and elongated.
- 6.1.5 Either place the rocks into separate piles or containers for each fraction. Tools or mechanical equipment may be used to move larger rocks, or alternatively, larger rocks may be marked using a colour code rather than sorting and moving them. This eliminates the need to move a rock before loading and weighing. If rock shape is being determined in accordance with Subsection 6.2, it may be necessary further separate each fraction into additional piles or containers for the flat, elongated and flat and elongated rocks.
- 6.1.6 As each container is filled, weigh on the balance and record the mass of the container and fraction ( $m_a$ ).
- 6.1.7 For coarse fractions, load the material for a fraction onto the truck. Determine the mass of the truck and fraction from a registered weighbridge ( $m_a$ ).
- 6.1.8 Continue size separation and weighing until the total gradation sample has been processed.

## **6.2 Particle shape**

- 6.2.1 Include all fractions which constitute ten or more percent of the sample mass and are larger than 75.0 mm.
- 6.2.2 Select the proportional calliper with the required ratio (Note 10.2).
- 6.2.3 Test each of the rocks in each of the fractions prepared for measurement, using the proportional calliper as follows:
  - a) Set the largest opening equal to the width of the rock. If the thickness of the rock can be placed within the smaller opening, the particle is deemed to be flat.
  - b) Set the largest opening equal to the length of the rock. If the width of the rock can be placed within the smaller opening, the particle is deemed to be elongated.
  - c) Set the largest opening equal to the length of the rock. If the thickness of the rock can be placed within the smaller opening, the particle is deemed to be non-cubical.
  - d) Retain the rocks and sort the rocks in each fraction being measured into the following four types, flat, elongated, flat and elongated, non-cubical and neither flat nor elongated nor non-cubical.
- 6.2.4 Determine the masses of the flat ( $m_3$ ), elongated ( $m_4$ ), flat and elongated types ( $m_5$ ) and non-cubical ( $m_6$ ).

## 7 Calculations

Calculations shall be as follows:

### 7.1 Particle size distribution

7.1.1 Calculate the mass retained for each fraction as follows:

$$m_r = \sum (m_a - m_c)$$

where  $m_r$  = individual mass retained for each fraction (kg)  
 $m_a$  = mass of truck/container and fraction (kg)  
 $m_c$  = mass of truck/container (kg)

7.1.2 Calculate the cumulative mass retained for each fraction as follows:

$$M = \sum m_r$$

where  $M$  = cumulative mass retained in each fraction (kg)  
 $m_r$  = individual mass retained for each fraction (kg)

7.1.3 Calculate the cumulative percent retained for each fraction as follows:

$$P_r = \frac{100M}{\sum (m_2 - m_1)}$$

where  $P_r$  = cumulative percent retained for each fraction (%)  
 $M$  = cumulative mass retained in each fraction (kg)  
 $m_2$  = mass of truck/container and sample (kg)  
 $m_1$  = mass of truck/container (kg)

7.1.4 Calculate the percent passing each fraction as follows:

$$P = 100 - P_r$$

where  $P$  = cumulative percent passing for each fraction (%)  
 $P_r$  = cumulative percent retained for each fraction (%)

### 7.2 Misshapen rocks

7.2.1 Calculate the total mass of sample to be from the particle size distribution from fractions which constitute ten or more percent of the sample mass and are larger than 75.0 mm as follows:

$$M_T = \sum m_r$$

where  $M_T$  = mass of sample from particle size distribution (kg)  
 $m_r$  = individual mass retained for each test fraction (kg)

7.2.2 For each test fraction calculate the percentage of flat rocks as follows:

$$P_f = \frac{m_3}{m_r} 100$$

where  $P_f$  = percentage of flat rocks  
 $m_3$  = mass of flat rocks in each test fraction (kg)  
 $m_r$  = individual mass retained for each test fraction (kg)

7.2.3 For each test fraction calculate the percentage of elongated rocks as follows:

$$P_e = \frac{m_4}{m_r} 100$$

where  $P_e$  = percentage of elongated rocks  
 $m_4$  = mass of elongated rocks in each test fraction (kg)  
 $m_r$  = individual mass retained for each test fraction (kg)

7.2.4 For each test fraction calculate the percentage of flat and elongated rocks as follows:

$$P_{fe} = \frac{m_5}{m_r} 100$$

where  $P_{fe}$  = percentage of flat and elongated rocks  
 $m_5$  = mass of flat and elongated rocks in each test fraction (kg)  
 $m_r$  = individual mass retained for each test fraction (kg)

7.2.5 For each test fraction calculate the percentage of non-cubical rocks as follows:

$$P_{nc} = \frac{m_6}{m_r} 100$$

where  $P_{nc}$  = percentage of non-cubical rocks  
 $m_6$  = mass of non-cubical rocks in each test fraction (kg)  
 $m_r$  = individual mass retained for each test fraction (kg)

7.2.6 For each test fraction calculate the weighted percentage of flat rocks as follows:

$$P_{wf} = \frac{P_f m_r}{M_T}$$

where  $P_{wf}$  = weighted percentage of flat rocks  
 $P_f$  = percentage of flat rocks  
 $m_r$  = individual mass retained for each test fraction (kg)  
 $M_T$  = mass of sample from particle size distribution (kg)

7.2.7 For each test fraction calculate the weighted percentage of elongated rocks as follows:

$$P_{we} = \frac{P_e m_r}{M_T}$$

where  $P_{we}$  = weighted percentage of elongated rocks  
 $P$  = percentage of elongated rocks  
 $m_r$  = individual mass retained for each test fraction (kg)  
 $M_T$  = mass of sample from particle size distribution (kg)

7.2.8 For each test fraction calculate the weighted percentage of flat and elongated as follows:

$$P_{wfe} = \frac{P_{fe} m_r}{M_T}$$

where  $P_{wfe}$  = weighted percentage of flat and elongated rocks  
 $P_{fe}$  = percentage of flat and elongated rocks  
 $m_r$  = individual mass retained for each test fraction (kg)  
 $M_T$  = mass of sample from particle size distribution (kg)

7.2.9 For each test fraction calculate the weighted percentage of flat and elongated as follows:

$$P_{wnc} = \frac{P_{nc} m_r}{M_T}$$

where  $P_{wnc}$  = weighted percentage of non-cubical rocks  
 $P_{nc}$  = percentage of non-cubical rocks  
 $m_r$  = individual mass retained for each test fraction (kg)  
 $M_T$  = mass of sample from particle size distribution (kg)

7.3 Calculate the misshapen rocks as follows:

$$MR = \sum P_{wf} + \sum P_{we} + \sum P_{wfe}$$

where  $MR$  = misshapen rocks (%)  
 $P_{wf}$  = weighted percentage of flat rocks  
 $P_{we}$  = weighted percentage of elongated rocks  
 $P_{wfe}$  = weighted percentage of flat and elongated rocks

7.4 Calculate the non-cubical rocks as follows:

$$NCR = \sum P_{wnc}$$

where  $NCR$  = non-cubical rocks (%)  
 $P_{wnc}$  = weighted percentage of non-cubical rocks

## **8 Records**

The following shall be recorded:

- 8.1 Date of sampling.
- 8.2 Material type.
- 8.3 Source of material.
- 8.4 Nominal size (mm).
- 8.5 Sampling location including GNSS reference if required.
- 8.6 Amount of material represented.
- 8.7 For material sampled in stockpile, the lot identification.
- 8.8 Name of sampler.
- 8.9 Reference to the sampling plan.
- 8.10 For material in a stockpile, a dimensioned plan of the lot showing sample location together with points of reference.
- 8.11 Any other relevant information.

## **9 Reporting**

The following shall be reported:

- 9.1 For sampling report the following:
  - 9.1.1 Date of sampling.
  - 9.1.2 Material type.
  - 9.1.3 Source of material.
  - 9.1.4 Sampling location.
  - 9.1.5 Lot identification.
  - 9.1.6 Reference to the sampling plan.
  - 9.1.7 The number of this Test Method, that is Q230.
- 9.2 For testing report the following values and information:
  - 9.2.1 The percent passing each fraction to the nearest 1 percent.
  - 9.2.2 The misshapen rocks in the sample to the nearest 1 percent (if required).
  - 9.2.3 The weighted percentage of flat, elongated and flat and elongated rocks and non-cubical rocks to the nearest 0.1 percent (if required).
  - 9.2.4 Calliper ratio's used.
  - 9.2.5 The number of this Test Method, that is Q230.

## 10 Notes on method

10.1 The mass of the test sample should be large enough to ensure a representative gradation is obtained with a desired level of accuracy. It should be large enough so that the addition or loss of the largest rock would not change the results by more than a specified percentage. For example, if the largest expected rock is 400 mm, then to provide an effect on the test results of 1% or less the sample size should be greater than 13,164 kg while an effect of 2% or less would require a sample size of 6,582 kg. Sample size can be calculated as follows:

$$m_{min} = \frac{1}{2} \left( 1 + \frac{\pi}{6} \right) D^3 \rho_s 1000 \frac{100}{P}$$

where  $m_{min}$  = minimum sampler size (kg)  
 $P$  = diameter of largest expected rock (m)  
 $\rho_s$  = apparent particle density (t/m<sup>3</sup>)  
 $P$  = effect on accuracy of addition/loss of largest rock (%)

For Table 1 of this method the effect on accuracy is assumed to be 2% and the apparent particle density is 2.70 t/m<sup>3</sup>.

10.2 A separate calliper ratio may be required for non-cubical rocks.

**Table 1 – Test portion and balance requirements**

Maximum particle size (mm)	Minimum test portion mass (kg)	Balance resolution (kg)	Balance limit of performance (kg)
500	12000	-	-
300	5600	-	-
250	1600	-	-
200	800	-	-
150	300	-	-
120	150	0.01	± 0.05
100	100	0.01	± 0.05

**Table 2 – Template size requirements**

Nominal aperture size (mm)	Tolerance for aperture (mm)
500	± 6.0
300	± 6.0
250	± 5.0
200	± 4.0
150	± 3.0



## Test Method Q231: Susceptibility of large armour rock to breakdown – drop test

### 1 Source

This Test Method is derived from EN13383-1 *Armour stone Part 1 Specification* and EN13383-2 *Armour stone Part 2 Test Methods*.

### 2 Scope

This Test Method sets out the procedure for determining the susceptibility of armour stone to breakage using the drop method. It is applicable to all sizes of armour stone above 20 kg.

### 3 Apparatus

The following apparatus is required:

- 3.1 Weighing device, such as a platform scale, having a capacity, resolution and maximum permissible error depending on the size of specimens tested in accordance with Table 1.
- 3.2 Sample handling equipment, an excavator of suitable capacity fitted with a rock grab / bucket capable of picking up individual armour stone specimens of the size required for the test and capable of lifting the specimen to a height of 3.0 m and then permitting the specimen to fall to the ground.
- 3.3 Test area, either constructed of a layer of rock fragments of similar size to those being tested or a 0.5 m thick reinforced concrete pad.

### 4 Sample selection

The sample shall be selected as follows:

- 4.1 It must be recognised that it is not practical to significantly move armour stone for testing purposes, therefore this method assumes that the testing will be undertaken in the quarry.
- 4.2 Determine the number of samples to be taken within the lot in accordance with the requirements of the specification, sampling plan or testing methodology as appropriate.
- 4.3 Determine the minimum number of specimens to be tested for the armour stone size from Table 2 (Note 9.1).
- 4.4 Use random stratified sampling to determine test locations in accordance with the requirements of the specification, sampling plan or testing methodology as appropriate, to determine five sampling locations.
- 4.5 At each sampling location select several specimens for testing. At each location about 20 percent of the number of specimens determined in Step 4.3 should be selected.
- 4.6 Move the selected specimens to the test area.

### 5 Procedure

The procedure shall be as follows:

- 5.1 Pick up, using an excavator bucket (a skeleton bucket is preferred as it minimises the fines which may be picked up with the specimen) a specimen to be tested (Note 9.2).
- 5.2 Tare the platform scale.

- 5.3 Place the specimen into the platform scale and record the mass ( $m_1$ ) (Note 9.3).
- 5.4 If  $m_2$  is less than the minimum mass of the armour stone size being tested, then the specimen is added to the next lower armour stone size, or if  $m_1$  is less than 20 kg, then the specimen is rejected and a replacement specimen is tested.
- 5.5 Pick up the specimen from the scale, and move to the impact area, raise the bucket to a height of 3 m above the test area and then drop the stone onto the test area.
- 5.6 Pick up the largest intact fragment of the specimen from the test area.
- 5.7 Tare the scale.
- 5.8 Place the largest intact fragment of the specimen on the scale and record its mass ( $m_2$ ).
- 5.9 Pick up the largest intact fragment of the specimen from the scale and place on the pile of tested specimens.
- 5.10 Using the bucket remove any remaining fragments from the test area.
- 5.11 Repeat Steps 5.1 to 5.9 until all specimens are tested.

## 6 Calculations

Calculations shall be as follows

- 6.1 Calculate the breakdown for each specimen as follows:

$$B = \frac{m_1 - m_2}{m_1} 100$$

where

$B$	=	breakdown (%)
$m_1$	=	original mass of specimen (kg)
$m_2$	=	mass of largest intact fragment of the specimen (kg)

- 6.2 Calculate the mean breakdown for the specimens tested.

## 7 Records

The following information shall be recorded during the testing.

- 7.1 Date and time of testing.
- 7.2 Test location.
- 7.3 Amount of material represented (tonnes).
- 7.4 Source of material.
- 7.5 Armour stone size tested.
- 7.6 Name of tester and excavator operators.
- 7.7 Details of plant used.
- 7.8 Any other relevant information.

## 8 Reporting

The following shall be reported:

- 8.1 Armour stone size tested (refer to Table 2).
- 8.2 Number of specimens tested.

- 8.3 Mean breakdown value to the nearest 1%.
- 8.4 The number of this Test Method, that is Q231.

## 9 Notes on method

- 9.1 The number of specimens to be tested should be slightly larger than the minimum number as shown in Table 2) to account for any undersize specimens being included in the batch.
- 9.2 It is critical that the specimen when it is picked up does not include fine material as this will skew the results to a failure situation as the ( $m_1$ ) mass will include these fines. When determining ( $m_2$ ) the same applies but then any extra material will tend to bias the results towards a pass situation.
- 9.3 The platform scales used to determine the mass of the specimens should be protected against damage by placing a heavy plywood sheet on its weighing surface and a truck or earthmoving tyre on top of that. This should provide adequate protection for the scale during weighing. Ensure that the scale is tared prior to weighing but after the protective equipment is in place. Also that it is critical that the loader operator should individually place the armour stone fragments on the tyres not drop them onto the tyres.

**Table 1 – Balance/weighbridge details and minimum levels of performance**

Mass of individual armour stone specimens (kg)	Capacity (kg)	Resolution / Divisions (kg)	Maximum permissible error (kg)
20 to 100	200	0.5	± 2
100 to 200	500	1	± 5
200 to 1000	2000	5	± 20
1000 to 5000	10000	10	± 50
>5000	50000	50	± 200

**Table 2 – Number of specimens to be tested**

Armour stone size (t)	Minimum number of specimens to be tested
10.0 to 15.0	10
6.0 to 10.0	10
3.0 to 6.0	20
1.0 to 3.0	20
0.3 to 1.0	40
Armour stone size (kg)	Minimum number of specimens to be tested
60 to 300	40
10 to 60	40
40 to 200	40
5 to 40	40
20 to 300	40

## Test Method Q232: Size distribution and shape – armour stone

### 1 Source

This Test Method is derived from EN13383-1 *Armour stone Part 1 Specification* and EN13383-2 *Armour stone Part 2 Test Methods*.

### 2 Scope

This method sets out the procedure for determining the size, distribution and related properties of armour stone. The method also allows the determination of the size of armour stone, maximum length ( $L$ ) and thickness ( $T$ ), as well as determining the  $L/T$  ratio. It is applicable to all sizes of armour stone above 50 kg.

### 3 Apparatus

The following apparatus is required:

- 3.1 Weighing device, such as a platform scale, having a capacity, resolution and maximum permissible error depending on the size of specimens tested in accordance with Table 1 (Note 9.1).
- 3.2 Sample handling equipment, an excavator of suitable capacity, fitted with a rock grab / bucket capable of picking up individual armour stone specimens of the size required for the test.
- 3.3 Tape measure and felt tip markers.
- 3.4 Spray paint for marking larger armour stone.

### 4 Sample selection

The following materials are required:

- 4.1 It must be recognised that it is not practical to significantly move armour stone for testing purposes, therefore this method assumes that the testing will be undertaken in the quarry.
- 4.2 Determine the number of samples to be taken within the lot in accordance with the requirements of the specification, sampling plan or testing methodology as appropriate.
- 4.3 Determine the minimum number of specimens to be tested for the armour stone size from Table 2.
- 4.4 Use random stratified sampling to determine test locations in accordance with the requirements of the specification, sampling plan or testing methodology as appropriate, to determine five sampling locations.
- 4.5 At each sampling location select several specimens for testing. At each location about 20 percent of the number of specimens determined in Step 4.3 should be selected.
- 4.6 Move the selected specimens to the test area.

### 5 Procedure

The procedure shall be as follows:

- 5.1 Pick up, using an excavator bucket (a skeleton bucket is preferred as it minimises the fines which may be picked up with the stone) a specimen to be tested.
- 5.2 Place the specimen on the ground so that the longest dimension is in a horizontal plane.

- 5.3 Using the tape measure, determine the length of the longest horizontal line through the specimen and mark the line on the specimen ( $L$ ).
- 5.4 Using a tape measure, measure and record the distance from the ground to the top of the specimen ( $T$ ).
- 5.5 Tare the scale.
- 5.6 Place the specimen on the scale and record its mass ( $m_1$ ).
- 5.7 Repeat Steps 5.1 to 5.6 until all specimens are tested.

## 6 Calculations

Calculations shall be as follows:

### 6.1 Size distribution

- 6.1.1 Calculate the total mass of sample follows:

$$M_T = \sum m_1$$

where  $M_T$  = mass of sample (kg)

$m_1$  = mass of each specimen (kg)

- 6.1.2 Calculate the mass of stone larger than absolute maximum mass for the armour stone size tested (Table 3) as follows:

$$m_2 = \sum m_1$$

where  $m_2$  = total mass of specimen larger than absolute maximum mass for the armour stone size tested (Table 3) (kg)

$m_1$  = mass of each specimen larger than absolute maximum mass for the armour stone size tested (Table 3) (kg)

- 6.1.3 Calculate the mass of stone between nominal maximum mass and absolute maximum mass for the armour stone size tested (Table 3) as follows:

$$m_3 = \sum m_1$$

where  $m_3$  = total mass of specimen between nominal maximum mass and absolute maximum mass for the armour stone size tested (Table 3) (kg)

$m_1$  = mass of each specimen between nominal maximum mass and absolute maximum mass for the armour stone size tested (Table 3) (kg)

- 6.1.4 Calculate the mass of stone between nominal minimum mass and nominal maximum mass for the armour stone size tested (Table 3) as follows:

$$m_4 = \sum m_1$$

where  $m_4$  = total mass of specimen between nominal minimum mass and nominal maximum mass for the armour stone size tested (Table 3) (kg)

$m_1$  = mass of each specimen between nominal minimum mass and nominal maximum mass for the armour stone size tested (Table 3) (kg)

6.1.5 Calculate the mass of stone smaller than nominal minimum mass for the armour stone size tested (Table 3) as follows:

$$m_5 = \sum m_1$$

where  $m_5$  = total mass of specimen smaller than nominal minimum mass for the armour stone size tested (Table 3) (kg)  
 $m_1$  = mass of each specimen smaller than nominal minimum mass for the armour stone size tested (Table 3) (kg)

6.1.6 Calculate the mass of stone smaller than absolute minimum mass for the armour stone size tested (Table 3) as follows:

$$m_6 = \sum m_1$$

where  $m_6$  = total mass of specimen smaller than absolute minimum mass for the armour stone size tested (Table 3) (kg)  
 $m_1$  = mass of each specimen smaller than absolute minimum mass for the armour stone size tested (Table 3) (kg)

6.1.7 Calculate the percent of stone larger than absolute maximum mass for the armour stone size tested (Table 3) as follows:

$$P_2 = \frac{m_2}{M_T} 100$$

where  $P_2$  = Percent of sample larger than absolute maximum mass for the armour stone size tested (Table 3) (kg)  
 $m_2$  = total mass of specimen larger than absolute maximum mass for the armour stone size tested (Table 3) (kg)  
 $M_T$  = mass of sample (kg)

6.1.8 Calculate the percent of stone between nominal maximum mass and absolute maximum mass for the armour stone size tested (Table 3) as follows:

$$P_3 = \frac{m_3}{M_T} 100$$

where  $P_3$  = Percent of sample between nominal maximum mass and absolute maximum mass for the armour stone size tested (Table 3) (kg)  
 $m_3$  = total mass of specimen between nominal maximum mass and absolute maximum mass for the armour stone size tested (Table 3) (kg)  
 $M_T$  = mass of sample (kg)

6.1.9 Calculate the percent of stone between nominal minimum mass and nominal maximum mass for the armour stone size tested (Table 3) as follows:

$$P_4 = \frac{m_4}{M_T} 100$$

where  $P_4$  = Percent of sample between nominal minimum mass and nominal maximum mass for the armour stone size tested (Table 3) (kg)

$m_4$  = total mass of specimen between nominal minimum mass and nominal maximum mass for the armour stone size tested (Table 3) (kg)

$M_T$  = mass of sample (kg)

6.1.10 Calculate the percent of stone smaller than nominal minimum mass for the armour stone size tested (Table 3) as follows:

$$P_5 = \frac{m_5}{M_T} 100$$

where  $P_5$  = Percent of sample smaller than nominal minimum mass for the armour stone size tested (Table 3) (kg)

$m_5$  = total mass of specimen smaller than nominal minimum mass for the armour stone size tested (Table 3) (kg)

$M_T$  = mass of sample (kg)

6.1.11 Calculate the percent of stone smaller than absolute minimum mass for the armour stone size tested (Table 3) as follows:

$$P_6 = \frac{m_6}{M_T} 100$$

where  $P_6$  = Percent of sample smaller than absolute minimum mass for the armour stone size tested (Table 3)(kg)

$m_6$  = total mass of specimen smaller than absolute minimum mass for the armour stone size tested (Table 3)(kg)

$M_T$  = mass of sample (kg)

## 6.2 Shape

6.2.1 For each specimen calculate the size ratio as follows:

$$L/T = \frac{L}{T}$$

where  $L/T$  = size ratio

$L$  = length of specimen (m)

$T$  = thickness of specimen (m)

6.2.2 For each size range calculate the total mass of specimen with a  $L/T \geq 3.0$  ( $m_2$ ) as follows:

$$m_2 = \sum m_1$$

where  $m_2$  = total mass of specimens with  $L/T \geq 3.0$

$m_1$  = mass of specimen, where  $L/T \geq 3.0$  (kg)

6.2.3 For each size range calculate the total mass of specimens with a  $L/T < 3.0$  ( $m_3$ ) as follows:

$$m_3 = \sum m_1$$

where  $m_3$  = total mass of specimens with  $L/T < 3.0$  (kg)

$m_1$  = mass of specimen, where  $L/T < 3.0$  (kg)

6.2.4 For each size range calculate percentage of specimens with a  $L/T \geq 3.0$  as follows:

$$L/T (\geq 3) = \frac{m_2}{m_2 + m_3} 100$$

where  $L/T (\geq 3)$  = size ratio  $\geq 3.0$  (%)

$m_2$  = total mass of specimens with  $L/T \geq 3.0$  (kg)

$m_3$  = total mass of specimens with  $L/T < 3.0$  (kg)

6.2.5 For each size range calculate percentage of specimens with a  $L/T < 3.0$  as follows:

$$L/T (< 3) = \frac{m_3}{m_2 + m_3} 100$$

where  $L/T (< 3)$  = size ratio  $< 3.0$  (%)

$m_2$  = total mass of specimens with  $L/T \geq 3.0$  (kg)

$m_3$  = total mass of specimens with  $L/T < 3.0$  (kg)

## 7 Records

The following information shall be recorded during the testing.

7.1 Date and time of testing.

7.2 Test location.

7.3 Amount of material represented (tonnes).

7.4 Source of material.

7.5 Armour stone size tested (refer to Table 3).

7.6 Name of tester and excavator operator.

7.7 Details of plant used.

7.8 Any other relevant information.

## 8 Reporting

The following shall be reported:



- 8.1 Armour stone size tested (refer to Table 3).
- 8.2 The following armour stone size limits to the nearest 1%:
- a) Stone larger than absolute maximum mass
  - b) Stone between nominal maximum mass and absolute maximum mass
  - c) Stone between nominal minimum mass and nominal maximum mass
  - d) Stone between nominal minimum mass and nominal maximum mass, and
  - e) Stone smaller than absolute minimum mass.
- 8.3 Size ratio ( $L/T$  ( $< 3$ )) to the nearest 1%.
- 8.4 The number of this Test Method, that is Q232.

## 9 Notes on method

- 9.1 The platform scales used to determine the mass of the specimens should be protected against damage by placing a heavy plywood sheet on its weighing surface and a truck or earthmoving tyre on top of that. This should provide adequate protection for the scale during weighing. Ensure that the scale is tared prior to weighing but after the protective equipment is in place. It is critical that the loader operator should individually place the armour stone fragments on the tyres not drop them onto the tyres.

**Table 1 – Balance/weighbridge details and minimum levels of performance**

Mass of individual armour stone specimens (kg)	Capacity (kg)	Resolution / Divisions (kg)	Maximum permissible error (kg)
20 to 100	200	0.5	± 2
100 to 200	500	1	± 5
200 to 1000	2000	5	± 20
1000 to 5000	10000	10	± 50
>5000	50000	50	± 200

**Table 2 – Number of specimens to be tested**

<b>Armour stone size (t)</b>	<b>Minimum number of specimens to be tested</b>
10.0 to 15.0	10
6.0 to 10.0	10
3.0 to 6.0	20
1.0 to 3.0	20
0.3 to 1.0	40
<b>Armour stone size (kg)</b>	<b>Minimum number of specimens to be tested</b>
60 to 300	50
10 to 60	50
40 to 200	50
5 to 40	50
20 to 300	50

**Table 3 – Standard armour stone sizes**

<b>Armour stone size (t)</b>	<b>Absolute minimum mass (t)</b>	<b>Nominal minimum mass (t)</b>	<b>Nominal maximum mass (t)</b>	<b>Absolute maximum mass (t)</b>
10.0 to 15.0	5.0	10.0	15.0	30.0
6.0 to 10.0	3.0	6.0	10.0	20.0
3.0 to 6.0	1.5	3.0	6.0	12.0
1.0 to 3.0	0.5	1.0	3.0	6.0
0.3 to 1.0	0.15	0.30	1.0	2.0
<b>Armour stone size (kg)</b>	<b>Absolute minimum mass (kg)</b>	<b>Nominal minimum mass (kg)</b>	<b>Nominal maximum mass (kg)</b>	<b>Absolute maximum mass (kg)</b>
60 to 300	30	60	300	600
10 to 60	5	10	60	120
40 to 200	20	40	200	400
5 to 40	2.5	5	40	80
20 to 300	7.5	20	300	600

*Note: Reproduced from Technical Specification MRTS43 Supply of armour stone*

## Test Method Q233: Deleterious fines index of fine aggregate

### 1 Source

This procedure was developed using the research report Cement Concrete and Aggregates Australia (January 2007), *Manufactured sand – National test methods and specification values*.

### 2 Scope

This Test Method describes the calculation of the deleterious fines index (*DFI*) of fine aggregate used in concrete.

The DFI is product of the methylene blue value and the percent of the aggregate finer than 0.075 mm. It is used in Transport and Main Roads [Technical Specifications](#) MRTS40 *Concrete Pavement Base* and MRTS70 *Concrete* and Australian Standard AS 2758.1 *Aggregates and rock for engineering purposes: Concrete aggregates to classify fine aggregates*.

### 3 Procedure

The procedure shall be as follows:

- 3.1 Determine the methylene blue value (*MBV*) in accordance with Test Method AS 1141.66.
- 3.2 Determine the percent finer than 0.075 mm test sieve ( $P_{0.075}$ ) in accordance with Test Methods AS 1141.11.1 (by washing) or AS 1141.12.

### 4 Calculations

Calculations shall be as follows:

- 4.1 Calculate the deleterious fines index as follows:

$$DFI = MBV \cdot P_{0.075}$$

where	<i>DFI</i>	=	Deleterious fines index
	<i>MBV</i>	=	Methylene blue value (mg/g)
	$P_{0.075}$	=	Percent finer than 0.075 mm test sieve

### 5 Reporting

The following shall be reported:

- 5.1 Methylene blue value (mg/g) to the nearest 0.1 mg/g.
- 5.2 Percent finer than 0.075 mm test sieve to the nearest 1 percent.
- 5.3 Deleterious fines index (refer to Table 1).
- 5.4 The number of this Test Method, that is Q233.

**Table 1 – Reporting intervals for DFI**

DFI	Reporting interval
≤50	nearest 1
>50	nearest 2

## Test Method Q303A: Preparation of asphalt core samples

### 1 Source

This Test Method was developed in-house and applies techniques evolved through internal departmental research investigations.

### 2 Scope

This Test Method describes the procedure for the preparation of asphalt core samples prior to testing. It involves cleaning, separation and sectioning of the core samples as appropriate using a hammer and bolster. For preparation using a masonry saw, refer to Test Method AS 2891.1.2.

### 3 Definition

For this Test Method, the following definition shall apply:

- 3.1 Constant mass - when air drying, a sample is considered to have reached a constant mass when the difference between successive determinations of mass, after a further 24 hours drying, is not more than 0.03 percent.

### 4 Apparatus

The following apparatus is required:

- 4.1 Hammer and bolster.  
4.2 Stiff wire brush.  
4.3 Marking crayon.

### 5 Procedure

Core sample shall be prepared as follows.

- 5.1 Remove any base material, seal, tack coat or other foreign matter from the core sample using the hammer and bolster. Take care when chipping to avoid damaging the core sample.
- 5.2 Brush the top and bottom surfaces of the core sample with the wire brush to remove any remaining foreign matter and to expose fresh binder.
- 5.3 Where different asphalt layers within the core sample are required to be separated, perform the following procedure:
- place the bolster along the junction of the two layers and strike firmly with the hammer
  - rotate the core sample through 180° and repeat Step 5.3 a)
  - rotate the core sample through 90° and repeat Step 5.3 a)
  - repeat Steps 5.3 b) and 5.3 c) until the two layers are separated.
- 5.4 The core sample needs to be dry when performing tests influenced by moisture content, for example, compacted density, voids properties. If dry samples are required:
- air dry each core specimen as appropriate to constant mass, or
  - vacuum dry each core specimen in accordance with Test Method Q324.
- 5.5 Mark each core specimen as appropriate with an identification number.

## Test Method Q303B: Preparation of asphalt mix from a core sample

### 1 Source

This Test Method was developed in-house using basic asphalt sampling principles and techniques evolved through internal departmental research investigations.

### 2 Scope

This Test Method describes the procedure for obtaining a representative sample of the asphalt within a compacted asphalt pavement from a core sample taken from the pavement.

### 3 Apparatus

The following apparatus is required:

- 3.1 Oven, of suitable capacity, having a temperature of about 150°C.
- 3.2 Sampling tube, rigid metal tube of 125 mm internal diameter having a bevelled or sharpened edge at one end and a length of about 200 mm.
- 3.3 Sample tray, a flat-bottomed tray of sufficient capacity to contain the mix comprising the asphalt core sample.

### 4 Procedure

The procedure shall be as follows:

- 4.1 Determine which of the top and bottom surfaces of the core sample has the greater surface texture and place the core sample on the sample tray with this surface downwards.
- 4.2 Place the sample tray containing the core sample in the oven.
- 4.3 Heat the core sample just sufficiently to allow ready separation of the mix particles without binder drainage or loss of shape (Note 5.1).
- 4.4 Remove the sample tray containing the softened but intact core sample from the oven.
- 4.5 Carefully position the bevelled or sharpened end of the sampling tube centrally against the upper surface of the core sample. With sufficient downward force and gentle rotation back and forth, carefully ease the sampling tube through the entire length of the core sample, progressively removing material on the outside of the tube and ensuring that:
  - a) if most of a particle is on the inside of the tube, the particle is included with the mix within the tube
  - b) if most of a particle is on the outside of the tube, the particle is included with the mix outside the tube, and
  - c) if the tube bisects a particle, the particle should be included with the mix either within the tube or outside the tube so that 50% of all such particles are included with the mix within the tube and 50% with the mix outside the tube.
- 4.6 Discard all mix outside the sampling tube.
- 4.7 Retain the mix within the sampling tube as a representative test portion of the mix within the core sample.

## **5 Notes on method**

- 5.1 The heating time will vary according to the sample dimensions. For 150 mm diameter core samples, a heating time of 15 to 30 minutes at 150°C is usually adequate.

## Test Method Q304A: Permeability of asphalt - ponding method

### 1 Source

This Test Method was developed in-house using techniques evolved through internal departmental research investigations in Waters TJ (1999) *Permeability of Asphalt – Ponding Method*, Report TT306, Materials Branch, Department of Main Roads.

### 2 Scope

This method describes the procedure for the laboratory determination of the permeability of asphalt using the ponding method. It is applicable to cylindrical asphalt specimens of 100 mm or 150 mm diameter, either cored from the pavement or manufactured in the laboratory. It is restricted to asphalt having permeability values within the range of 0.1 to 3000  $\mu\text{m/s}$ .

### 3 Definition

For this method, the following definition shall apply:

- 3.1 Constant mass - when air drying, a sample is considered to have reached a constant mass when the difference between successive determinations of mass, after a further 24 hours drying, is not more than 0.03 percent.

### 4 Apparatus

The following apparatus is required:

- 4.1 Balance of suitable capacity, with a resolution of at least 0.1 g and with a limit of performance within the range of  $\pm 0.5$  g.
- 4.2 Laboratory permeameter, a clear perspex cylinder of known internal diameter having a wall thickness of about 3 mm and a length of 225 mm with etched measuring marks at 165 mm and 185 mm (Figure 1). The external diameter of the cylinder needs to be either 100 mm or 150 mm, matching the diameter of the asphalt specimen.
- 4.3 Funnel, of appropriate dimensions to contain the asphalt specimen (Figure 1).
- 4.4 Tripod, of appropriate dimensions to support the collection funnel, specimen and cylinder above the beaker.
- 4.5 Beaker, of 200 mL capacity.
- 4.6 Container, of 1 L capacity and fitted with a pouring lip.
- 4.7 Stopwatch or other suitable timing device, with a resolution not exceeding 0.1 seconds.
- 4.8 Spatula, to apply silicone sealant to the cylinder and specimen.
- 4.9 Calliper, suitable for measuring the dimensions of the asphalt specimen, with a resolution not exceeding 0.1 mm and conforming to ISO 13385 or JIS B 7507.

### 5 Materials

The following materials are required:

- 5.1 Silicone sealant (Note 9.1).

## 6 Procedure

The procedure shall be as follows:

- 6.1 If the specimen is not dry or has been extracted using Subsection 7.2 (wet coring method) of Test Method AS 2891.1.2, dry the specimen as follows:
  - a) air dry the specimen to constant mass, or
  - b) vacuum dry the specimen in accordance with Test Method Q324.
- 6.2 Measure the thickness of the specimen using the calliper at eight evenly distributed points around the perimeter and calculate the mean thickness.
- 6.3 Measure the diameter of the specimen using the calliper at four evenly distributed points around the perimeter and calculate the mean diameter.
- 6.4 Apply a thin layer of silicone sealant to completely seal the circumferential wall of the specimen.
- 6.5 Apply silicone sealant to the bottom edge of the cylinder and place the cylinder centrally on top of the specimen. Use additional sealant as required to seal the joint between the cylinder and the specimen, ensuring that the sealant does not penetrate inside the cylinder.
- 6.6 Allow the silicone sealant to cure to a firm and tack-free state.
- 6.7 Position the funnel in the tripod and then seat the specimen and attached cylinder in the funnel in an upright position.
- 6.8 Using the container, pour water into the cylinder until the water level is above 185 mm.
- 6.9 Allow the water to run through the specimen for 5 minutes or until the water level drops about 50 mm (Note 9.2).
- 6.10 Pour additional water into the cylinder until the water level is just above 185 mm.
- 6.11 Record the time taken for the water level to drop from 185 mm to 165 mm to the nearest 0.1 seconds.
- 6.12 Repeat Steps 6.10 to 6.11 twice (Notes 9.3 and 9.4).

## 7 Calculations

Calculations shall be as follows:

- 7.1 Calculate the mean of the three time measurements.
- 7.2 Calculate the volume of the cylinder between the 165 mm and 185 mm marks as follows:

$$V = \frac{\pi D^2}{200}$$

where  $V$  = volume of cylinder between 165 mm and 185 mm marks (mL)  
 $D$  = internal diameter of cylinder (mm)

- 7.3 Calculate the flow rate as follows (Note 8.5):

$$F = \frac{V}{t}$$

where  $F$  = flow rate (mL/s)  
 $V$  = volume of cylinder between 165 mm and 185 mm marks (mL)  
 $t$  = mean time for water level to drop from 185 mm to 165 mm (s)



7.4 Calculate the effective head of water as follows (Note 8.5):

$$h_e = \frac{h_1 + h_2}{2}$$

where  $h_e$  = effective head (mm)  
 $h_1$  = initial head (mm)  
 $h_2$  = final head (mm)

In the usual case when the initial head is 185 mm and the final head is 165 mm, the effective head will be 175 mm.

7.5 Calculate the hydraulic gradient as follows:

$$i = \frac{h_e + L}{L}$$

where  $i$  = hydraulic gradient  
 $h_e$  = effective head (mm)  
 $L$  = thickness of specimen (mm)

7.6 Calculate the cross-sectional area of the specimen as follows:

$$A_s = \left( \frac{\pi D_s^2}{4} \right) 10^{-6}$$

where  $A_s$  = cross-sectional area of specimen (m<sup>2</sup>)  
 $D_s$  = diameter of specimen (mm)

7.7 Calculate the permeability as follows:

$$k = \frac{F}{A_s i}$$

where  $k$  = permeability (µm/s)  
 $F$  = flow rate (mL/s)  
 $A_s$  = cross-sectional area of specimen (m<sup>2</sup>)  
 $i$  = hydraulic gradient

## 8 Reporting

The following shall be reported:

- 8.1 Whether the specimen is a core or a laboratory prepared specimen.
- 8.2 Test location including a longitudinal (chainage) and a lateral (offset) reference, for a core specimen.
- 8.3 Mix and compaction details, for a laboratory prepared specimen.
- 8.4 Permeability to three significant figures (µm/s).
- 8.5 The permeability category and description (Table 1), and
- 8.6 The number of this Test Method, that is Q304A.

## 9 Notes on method

- 9.1 Before handling the silicone sealant, the operator should consult the relevant SDS.

- 9.2 If there is no change in the water level after 5 minutes, omit Steps 6.10 to 6.12 and Clause 7, and record the permeability as 0  $\mu\text{m/s}$ .
- 9.3 For asphalt of very low permeability (Table 1), a single time measurement will suffice and Steps 6.12 and 7.1 may be omitted.
- 9.4 Steps 6.10 to 6.12 provide a measure of the flow rate of water through the specimen. Where the flow rate is slow (say less than 0.05 mL/s), an alternative approach may be used involving a single measurement of the volume of water collected in a beaker positioned beneath the specimen over a specified time period. The effective head will then be the mean of the initial and final head over the period when the water volume is collected beneath the specimen.

**Table 1 – Permeability category and description**

Permeability ( $\mu\text{m/s}$ )	Category	Description
0	-	Impermeable
0.01 - 0.10	A1	Very low permeability
0.11 - 1.00	A2	Low permeability
1.00 - 10.0	B	Moderately permeable
10.1 - 100	C	Permeable
101 - 1000	D	Moderately free draining

Figure 1 – Laboratory permeameter

(Dimensions in millimetres)

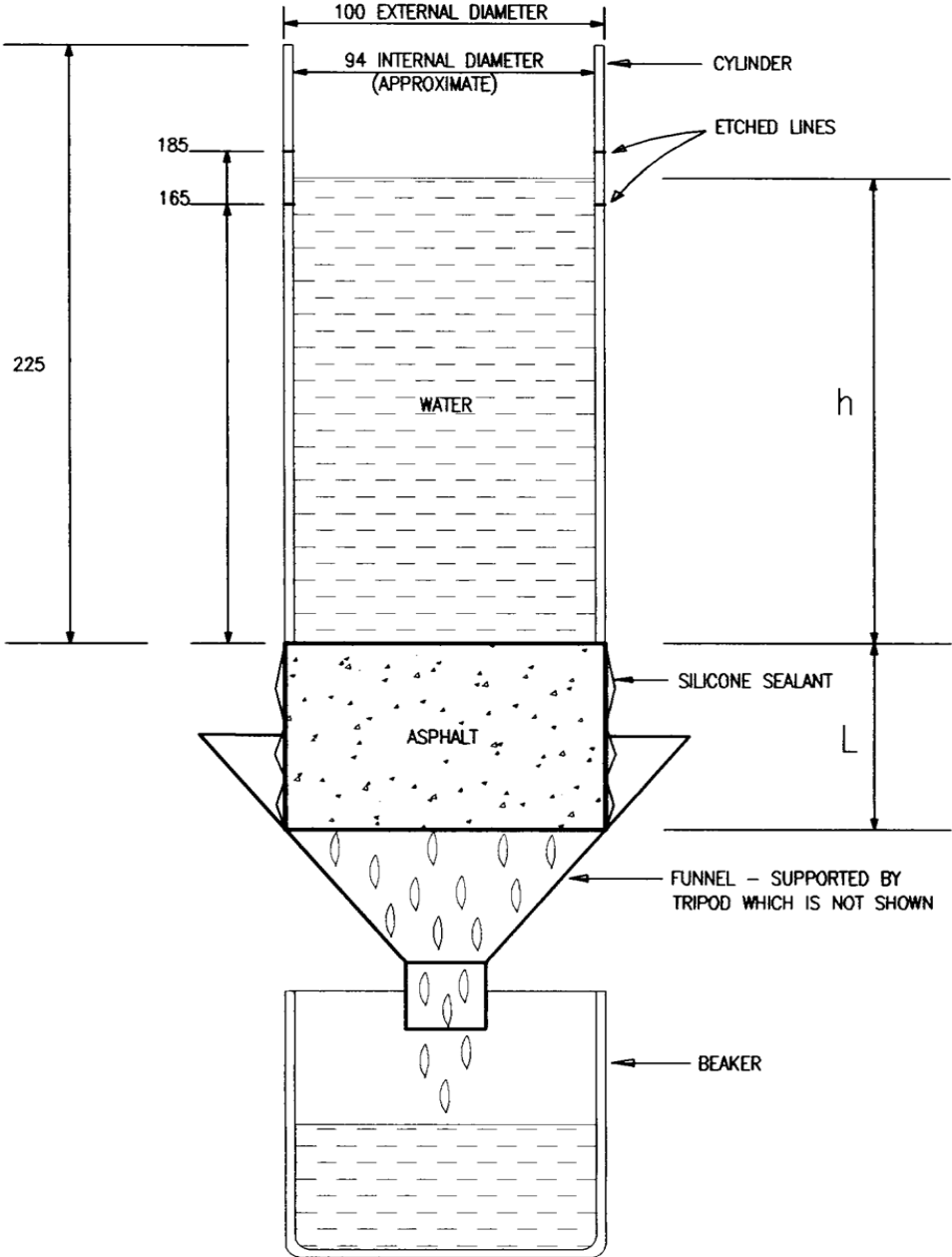

## Test Method Q304B: Assessment of asphalt permeability

### 1 Source

This Test Method was developed in-house but uses test specimen preparation based on AS/NZS 2891.2.2: *Sample preparation – Compaction of asphalt test specimens using a gyratory compactor*, and permeability testing in accordance with Test Method Q304A.

### 2 Scope

This Test Method sets out the procedure for determining the permeability of asphalt mix corresponding to a specific level of air voids. It involves establishing the relationship between permeability and air voids through permeability testing of asphalt test specimens prepared at three air voids using a gyratory compactor.

### 3 Apparatus

Where appropriate, the working tolerances of apparatus are contained in Table 1.

The following apparatus is required:

- 3.1 Gyratory compactor, capable of applying a vertical loading stress of 240 kPa to a test specimen in a mould at a rate of 60 rpm and at a fixed angle of 2° for 100 mm diameter specimens and 3° for 150 mm diameter specimens measured at the centre of the height of the mould. The compactor needs to be fitted with the means for providing a continuous readout of test specimen height with the number of compaction cycles.
- 3.2 Specimen mould assembly, as described in AS/NZS 2891.2.2 for 100 mm and 150 mm diameter test specimens.
- 3.3 Wearing discs, steel discs of thickness 0.9 mm and diameter 99.8 mm or 149.8 mm as appropriate.
- 3.4 Specimen extractor, of suitable design to enable the test specimen to be removed intact from the mould.
- 3.5 Oven, thermostatically controlled at an operating temperature corresponding to the appropriate compaction temperature specified in Table 2.
- 3.6 Balance of a suitable capacity, having a resolution of at least 0.1 g and with a limit of performance within the range of  $\pm 0.5$  g.
- 3.7 Thermometer, a partial immersion thermometer or other suitable temperature measuring device having a temperature range which includes 150°C, and graduated to 1°C or less with an uncertainty of no more than 0.5°C.
- 3.8 Assorted mixing and handling apparatus, such as steel trays, trowels, spatulas and scoops.

### 4 Materials

The following materials are required:

- 4.1 Paper discs, having a diameter of about 100 mm.
- 4.2 Lubricant, suitable light oil for lubricating the paper discs (Note 8.1).

## 5 Procedure

The procedure shall be as follows:

- 5.1 Determine the maximum density of the mix in accordance with Test Method AS/NZS 2891.7.1.
- 5.2 Select target air voids of 9% as determined in accordance with Test Method Q311.
- 5.3 Bring the oven to an operating temperature corresponding to the compaction temperature specified for the binder and asphalt type in Table 2.
- 5.4 Select the appropriate specimen mould assembly for the mix nominal size and place it in the oven for a period of at least one hour.
- 5.5 Remove the mould assembly from the oven and position a lubricated paper disc on the lower wearing disc in the mould.
- 5.6 Using the maximum density of the mix, the dimensions of the mould assembly and the test specimen height relevant to the mix nominal size in Table 3, estimate the quantity of mix required to provide the target air voids.
- 5.7 Transfer this quantity of mix into the mould and return the mould assembly to the oven for  $60 \pm 10$  minutes.
- 5.8 Remove the mould assembly from the oven, place a thermometer in the mix and measure the temperature. Provided that the temperature is within the compaction temperature range specified in Table 2, level the mix in the mould and place a lubricated paper disc on the mix surface (Note 8.2).
- 5.9 Place the upper wearing disc and top platen on the mix in the mould, position the mould assembly in the gyratory compactor and lock the mould assembly in place.
- 5.10 Compact the mix in the mould assembly until the test specimen height relevant to the mix nominal size in Table 3 is reached.
- 5.11 Remove the mould assembly from the gyratory compactor and take off the upper platen.
- 5.12 Allow the mould to cool sufficiently in air and then remove the test specimen from the mould using the specimen extractor, while ensuring the test specimen remains intact and shows no deformation.
- 5.13 Determine the compacted density / bulk density of the test specimen in accordance with Test Methods AS/NZS 2891.9.2, AS/NZS 2891.9.3 or Q306C as appropriate.
- 5.14 Determine the air voids of the test specimen in accordance with Test Method Q311.
- 5.15 Repeat Steps 5.4 to 5.14 until three test specimens are prepared having an air voids of  $9 \pm 1\%$ .
- 5.16 Repeat Steps 5.4 to 5.14 using a target air voids of 7% until three test specimens are prepared having an air voids of  $7 \pm 1\%$ .
- 5.17 Repeat Steps 5.4 to 5.14 using a target air voids of 5% until three test specimens are prepared having an air voids of  $5 \pm 1\%$ .
- 5.18 Remove the silicone sealant from each of the nine test specimens and determine the permeability of each in accordance with Test Method Q304A.

- 5.19 Do not accept any of the nine test specimens determined to be impermeable or have a very low permeability as defined in Test Method Q304A for the assessment of asphalt permeability. When not accepted, prepare a replacement test specimen using an appropriate higher air voids as described in Steps 5.4 to 5.14, and test its permeability as described in Step 5.18.

## 6 Calculations

Calculations shall be as follows:

- 6.1 Using the permeability and air voids results for each test specimen, determine the linear regression relationship between log permeability and air voids.
- 6.2 Accept the relationship determined in Step 6.1 provided that its coefficient of determination ( $r^2$ ) satisfies the relevant minimum value of Table 4. Otherwise, test additional test specimens prepared at appropriate air voids within the range of 5 to 9%, as described in Steps 5.4 to 5.14 and 5.18 to 6.1, until the requirements of Table 4 are met.
- 6.3 Where required, calculate the permeability value corresponding to a specific value of air voids from this relationship.

## 7 Reporting

The following shall be reported:

- 7.1 The air voids and permeability test results for each test specimen.
- 7.2 The linear regression relationship between log permeability and air voids.
- 7.3 Where required, the permeability value corresponding to a specific value of air voids to the nearest 1  $\mu\text{m/s}$ .
- 7.4 The number of this Test Method, that is Q304B.

## 8 Notes on method

- 8.1 Before handling the oil, the operator should consult the relevant SDS.
- 8.2 If the temperature of the mix falls below the compaction temperature range, the mix may be reheated. This will involve returning the mould assembly containing the mix to the oven until it reaches oven temperature and then repeating Step 5.7.

**Table 1 - Specifications and working tolerances of apparatus**

Item	Unit	Value	Working tolerance
<b>Gyratory compactor</b>			
Load application rate	rpm	60	$\pm 5$
<b>Wearing disk</b>			
Diameter	mm	99.8 or 149.8	$\pm 0.1$
Thickness	mm	0.9	$\pm 0.02$
<b>Oven</b>			
Temperature	$^{\circ}\text{C}$	150	$\pm 5$

**Table 2 – Mix compaction temperatures**

Specified binder class or type	Warm mix asphalt additive in binder	Dense graded and stone mastic asphalt	Open graded asphalt	Gap graded asphalt
Class 170 bitumen	Nil	142 ± 3°C	-	-
	1 to < 2% wax, or 1 – 3% water	142 ± 3°C	-	-
	2% wax	132 ± 3°C	-	-
	0.4 – 0.8% surfactant	127 ± 3°C	-	-
Class 320 and Class 450	Nil	150 ± 3°C	-	-
	1 to < 2% wax, or 1 – 3% water	150 ± 3°C	-	-
	2% wax	140 ± 3°C	-	-
	0.4 – 0.8% surfactant	135 ± 3°C	-	-
Class 600 bitumen and M1000 multigrade bitumen	Nil	155 ± 3°C	-	-
	1 to < 2% wax, or 1 – 3% water	155 ± 3°C	-	-
	2% wax	145 ± 3°C	-	-
	0.4 – 0.8% surfactant	140 ± 3°C	-	-
Polymer modified binder (including crumb rubber)	Nil	160 ± 3°C	135 ± 3°C	160 ± 3°C
	1 to < 2% wax	160 ± 3°C	135 ± 3°C	160 ± 3°C
	2% wax, or 0.4 – 0.8% surfactant	150 ± 3°C	135 ± 3°C	160 ± 3°C

**Table 3 - Test specimen height**

Mix nominal size	Unit	Value	Working tolerance
DG14	mm	50	± 2
DG20	mm	65	± 2
DG28	mm	90	± 2

**Table 4 - Coefficient of determination ( $r^2$ ) minimum values**

Number of test results	Minimum value	Number of test results	Minimum value
9	0.636	15	0.411
10	0.585	16	0.388
11	0.540	17	0.367
12	0.501	18	0.348
13	0.467	19	0.331
14	0.437	20	0.315

## Test Method Q305: Stability, flow and stiffness of asphalt – Marshall

### 1 Source

This Test Method is based on AS/NZS 2891.5: *Methods of sampling and testing asphalt, Method 5: Compaction of asphalt by Marshall method and determination of stability and flow – Marshall procedure*. It differs from this Australian Standard by extending the range of asphalt mixes tested with companion alterations to test specimen preparation, apparatus requirements and some other procedural variations.

### 2 Scope

This Test Method sets out the procedure for preparing test specimens of freshly mixed asphalt (either produced in the laboratory or at a mixing plant) by the Marshall procedure and determining stability, flow and stiffness (Marshall Quotient) values of the specimens using the Marshall apparatus. It is applicable to asphalt mixes not exceeding 20 mm nominal size.

### 3 Apparatus

Where appropriate, the working tolerances of apparatus are contained in Tables 1 and 2. An example of the 101.6 mm breaking head is in AS/NZS 2891.5 Figure 1 with tolerances included in Clause 4 (b). Examples of a typical hand compaction hammer, compaction pedestal and specimen mould assembly are contained in AS/NZS 2891.5 Figures 2, 3 and 4.

The following apparatus is required:

- 3.1 Specimen mould assembly, consisting of:
  - a) a cylindrical steel or brass compaction mould having an internal diameter of 101.6 mm, a height of 89 mm and a thickness of 6 mm
  - b) a mould base with a thickness of 18 mm, and
  - c) an extension collar having an internal diameter of 101.6 mm, a height of 70 mm and a thickness of 6 mm.
- 3.2 Hand compaction hammer, consisting of, a flat circular tamping face having a diameter of 98.5 mm, and a sliding weight with a mass of 4.53 kg and a free fall of 457 mm (Notes 9.1, 9.2, 9.3 and 9.4).
- 3.3 Hand compaction pedestal, consisting of:
  - a) A wooden block, of approximate dimensions 200 mm square and 450 mm thick, capped by a steel plate of approximate dimensions 300 mm square and 25 mm thick, with an air-dry density of 720 kg/m<sup>3</sup>.
  - b) The steel plate securely attached to the block which is secured to a solid concrete floor or slab. Suitable guides for restraining the compaction mould and locating the compaction hammer centrally during compaction may be attached to the block.
- 3.4 Specimen extrusion jack, consisting of a hydraulic jack fitted with a plate on the ram and located within a metal frame that retains the mould during extrusion of a test specimen. The dimensions of the plate are 100 mm diameter and 6 mm thick.



- 3.5 Breaking head, consisting of upper and lower cylindrical segments each having an accurately machined inside cylinder face. The lower segment mounted on a base having two perpendicular guide pins extending upwards. Guide bushes on the upper segment are located to direct the segments together without binding or loose motion on the guide pins.
- 3.6 Marshall testing machine, gear driven at a constant speed to give a rate of travel on the platen of 51 mm/min when the force is being applied, and capable of applying forces up to at least 22 kN. The machine is fitted with one of the following measurement systems:
- Elastic load ring and two flow gauges. The load ring inserted between the breaking head and the loading beam or crosshead to measure the force on the test specimen. With a capacity of at least 22 kN and conforming to a Class A device as defined in AS 2193 for forces up to 4.5 kN and conforming to a Class B device as defined in AS 2193 for forces between 4.5 kN and its maximum loading. The flow gauges are placed on the guide pins of the breaking head and capable of measuring the vertical deformation of the test specimen from the onset of load. The gauges have a scale interval of no more than 0.1 mm and conform to the requirements of ISO 463 or JIS B 7503, or
  - Load cell and transducer and appropriate continuous recording device of a capacity and accuracy at least equivalent to that of the load ring and flow gauges described in Clause 3.6 a).
- 3.7 Water bath, mechanically agitated and maintained at a temperature of 60°C. The bath is at least 150 mm deep and fitted with a perforated shelf about 50 mm from the bottom.
- 3.8 Oven, thermostatically controlled at an operating temperature corresponding to the appropriate compaction temperature specified in Table 3.
- 3.9 Hotplate, suitable for heating the mixing apparatus.
- 3.10 Balance of suitable capacity, with a resolution of at least 0.1 g and with a limit of performance within the range of  $\pm 0.5$  g.
- 3.11 Thermometer, a partial immersion thermometer or other suitable temperature measuring device having a temperature range which includes the appropriate range of Table 3, and graduated to 1°C or less with an uncertainty of no more than 0.5°C.
- 3.12 Measuring device, suitable for the measurement of the height of test specimens and with a resolution not exceeding 1 mm.
- 3.13 Marker.
- 3.14 Mixing apparatus, such as steel tray, steel trowel, spatulas and scoop.

## 4 Materials

The following materials are required:

- Lubricant, suitable grease or viscous oil for lubricating the compaction moulds (Note 9.5).
- Paper segments, of sufficient size to cover the mould base.

## 5 Preparation

Perform the following for each test specimen to be prepared:

- Bring the oven to an operating temperature corresponding to the compaction temperature specified for the binder and asphalt type in Table 3.
- Assemble the compaction mould (Note 9.6).

- 5.3 Place the compaction mould in the oven for approximately 1 hour.
- 5.4 Place the appropriate mixing apparatus on the hotplate.
- 5.5 Using the expected compacted density for the mix, calculate the required mass of the mix for the compaction mould to give the desired specimen height of 63.5 mm (Note 9.7).
- 5.6 Prepare the mix in accordance with Subsection 8.2 of Test Method AS/NZS 2891.1.1.
- 5.7 Remove the compaction mould from the oven and position a paper segment on the base within the mould.
- 5.8 Transfer the mix into the mould and level the surface of the mix, taking care to avoid segregation.
- 5.9 Place the mould in the oven for  $60 \pm 5$  minutes.
- 5.10 Remove the mould from the oven and measure the mix temperature (Note 9.8). Provided the temperature of the mix is within the compaction temperature range specified in Table 3, position a paper segment on the surface of the mix (Note 9.9). Discard the mix test portion if it has not reached the specified temperature range.
- 5.11 Transfer the compaction mould to the compaction pedestal and compact the mix using the specified number of blows of the compaction hammer at a rate of 60 to 70 blows per minute with the hammer axis held vertically (Note 9.2). Where the number of blows is not specified, use 50 blows.
- 5.12 Remove the collar and base then reassemble the compaction mould with the test specimen inverted (Note 9.10).
- 5.13 Compact the mix further using the specified number of blows of the compaction hammer at a rate of 60 to 70 blows per minute (Note 9.2). Where the number of blows is not specified, use 50 blows.
- 5.14 Remove the collar and base plate from the compaction mould and paper segments from the test specimen (where relevant) and mark the face of the test specimen clearly with an identification number (Note 9.11).
- 5.15 Allow the mould to cool in air and then extrude the test specimen.

## **6 Testing of specimens**

The testing shall be as follows:

- 6.1 Remove any lip formed around the edges of each test specimen without damage to the test specimen.
- 6.2 Measure the height of each test specimen at four points evenly spaced around the specimen and calculate the mean height. Discard any test specimen having a mean height outside the range of 57 to 70 mm (Note 9.12).
- 6.3 Clean the inside surfaces of the breaking head and lightly grease the guide pins.
- 6.4 Place the breaking head segments (where practicable) and test specimens in the water bath for 30 to 40 minutes.

- 6.5 Remove the breaking head segments from the water bath (where relevant) and complete Steps 6.6 and 6.7 within 30 seconds. If Steps 6.6 and 6.7 are not completed within 30 seconds of removal from the water bath and no load has been applied to the test specimen, return the breaking head (where practicable) and test specimen to the water bath for at least 10 minutes and repeat Steps 6.5 to 6.7. If the test specimen is removed from the water bath for more than five minutes, repeat Steps 6.4 to 6.7.
- 6.6 Remove a test specimen from the water bath and place it centrally on its side in the lower segment of the breaking head. Place the upper segment of the breaking head on the test specimen and place the complete assembly centrally on the Marshall testing machine.
- 6.7 Zero the measurement system, start the Marshall testing machine and perform the test as follows:
- 6.7.1 For the load ring and flow gauge system, apply the load until shear failure causes the load ring dial gauge reading to decrease. Remove the flow gauges immediately from the breaking head and record the dial gauge reading to the nearest division and the flow gauge readings to the nearest 0.1 mm.
- 6.7.2 For the load cell and transducer system, apply the load until shear failure causes the load cell reading to decrease. Record the maximum load reading and the flow reading.
- 6.8 Repeat Steps 6.6 to 6.7.2 for each of the remaining test specimens.

## 7 Calculations

Calculations shall be as follows:

### 7.1 Stability

- 7.1.1 Calculate the load ( $L$ ) applied to each test specimen at shear failure using as appropriate:
- the recorded dial gauge reading and the calibration relationship for the load ring as determined in Step 6.7.1, or
  - the test load cell reading as determined in Step 6.7.2.
- 7.1.2 Calculate the stability of each test specimen as follows:

$$S = LF$$

where

$S$	=	stability of test specimen (kN)
$L$	=	load at shear failure (kN)
$F$	=	correction factor of Table 4 according to the height of the test specimen

- 7.1.3 Calculate the stability of the asphalt as the mean of the test specimen stability values.

### 7.2 Flow

- 7.2.1 Calculate the flow of each test specimen at shear failure using as appropriate:
- the mean of the two flow gauge readings recorded in Step 6.7.1, or
  - the test transducer reading as determined in Step 6.7.2.
- 7.2.2 Calculate the flow of the asphalt as the mean of the test specimen flow values.

### 7.3 Stiffness (Marshall Quotient)

Calculate the stiffness (Marshall Quotient) of the asphalt as follows:

$$\text{Stiffness} = \frac{\text{stability of the asphalt}}{\text{flow of the asphalt}}$$

## 8 Reporting

The following shall be reported:

- 8.1 Stability to the nearest 0.1 kN.
- 8.2 Flow to the nearest 0.1 mm.
- 8.3 Stiffness (Marshall Quotient) to the nearest 0.1 kN/mm.
- 8.4 The number of blows applied to each face of the test specimens during compaction.
- 8.5 The number of this Test Method, that is Q305.

## 9 Notes on method

- 9.1 Where a mechanical compactor is used instead of the hand compactor, the mass, free fall and design of the hammer foot should be identical to those of the hand compaction hammer and the automatic compactor should be securely anchored to a concrete base.
- 9.2 Where a mechanical compactor is used or a hand compactor is used, alignment with interlaboratory assessment or proficiency testing schemes for mean density of a compacted specimen is required.
- 9.3 Where a mechanical compactor is used, it should be calibrated against hand compaction to determine the number of blows equivalent to the specified number of blows of hand compaction. Calibration checks should be performed on a regular basis and the difference between the density results obtained using the mechanical and hand compaction method should be no greater than 0.01 t/m<sup>3</sup>. Calibration should be conducted using quartered samples of the mix.
- 9.4 To ensure free fall of the weight is maintained, the shaft of the hammer should be thoroughly cleaned and dried after each set of compaction blows.
- 9.5 Before handling the lubricant, the operator should consult the relevant SDS.
- 9.6 The cylinder, base and collar may be lightly greased prior to assembly to prevent asphalt mix adhering to the mould.
- 9.7 For 101.6 mm diameter mould, approximately 1250 g is usually required.
- 9.8 For mixes susceptible to loss of binder by the draindown effect, for example, open graded asphalt, the mix in the mould may be tipped out, then returned to the mould and levelled to evenly distribute the binder, taking care to avoid segregation.
- 9.9 The paper segment may be lightly greased prior to placement on the mix to prevent asphalt mix adhering to the compaction hammer.
- 9.10 Where the paper segments have been lightly greased, they may be removed from the test specimen.
- 9.11 For coarsely graded mixes, for example, open graded asphalt, removal of the base plate may be delayed until the mould has cooled.

9.12 Any discarded test specimen should be replaced with an additional test specimen prepared in accordance with Steps 5.1 to 6.2.

**Table 1 – Compaction equipment dimensions**

Compaction equipment	Dimension	Tolerance
<b>Compaction mould</b>		
Internal diameter of cylinder (mm)	101.6	± 0.2
Internal diameter of collar (mm)	101.6	± 0.2
Wall thickness (mm)	6	minimum
<b>Compaction hammer</b>		
Mass of sliding weight (kg)	4.53	± 0.02
Free fall of sliding weight (mm)	457	± 1
Diameter of tamping face (mm)	98.5	± 0.1
<b>Compaction pedestal</b>		
Wooden block, air dry density (kg/m <sup>3</sup> )	720	± 50

**Table 2 – Test apparatus requirements**

Apparatus	Requirement	Tolerance
<b>Marshall testing machine</b>		
Rate of travel (mm/min)	51	± 3
<b>Water bath</b>		
Temperature (°C)	60	± 1
<b>Oven</b>		
Temperature (°C)	Table 3	± 5

**Table 3 – Mix compaction temperatures**

Specified binder class or type	Warm mix asphalt additive in binder	Dense graded and stone mastic asphalt	Open graded asphalt	Gap graded asphalt
Class 170 bitumen	Nil	142 ± 3°C	-	-
	1 to < 2% wax, or 1 – 3% water	142 ± 3°C	-	-
	2% wax	132 ± 3°C	-	-
	0.4 – 0.8% surfactant	127 ± 3°C	-	-
Class 320 and Class 450	Nil	150 ± 3°C	-	-
	1 to < 2% wax, or 1 – 3% water	150 ± 3°C	-	-
	2% wax	140 ± 3°C	-	-
	0.4 – 0.8% surfactant	135 ± 3°C	-	-
	Nil	155 ± 3°C	-	-

Specified binder class or type	Warm mix asphalt additive in binder	Dense graded and stone mastic asphalt	Open graded asphalt	Gap graded asphalt
Class 600 bitumen and M1000 multigrade bitumen	1 to < 2% wax, or 1 – 3% water	155 ± 3°C	-	-
	2% wax	145 ± 3°C	-	-
	0.4 – 0.8% surfactant	140 ± 3°C	-	-
Polymer modified binder (including crumb rubber)	Nil	160 ± 3°C	135 ± 3°C	160 ± 3°C
	1 to < 2% wax	160 ± 3°C	135 ± 3°C	160 ± 3°C
	2% wax, or 0.4 – 0.8% surfactant	150 ± 3°C	135 ± 3°C	160 ± 3°C

**Table 4 – Factors for correcting Marshall stability for specimen height**

Specimen height (mm)	Correction factor (F)	Specimen height (mm)	Correction factor (F)
57	1.19	64	0.99
58	1.16	65	0.96
59	1.13	66	0.94
60	1.10	67	0.92
61	1.07	68	0.90
62	1.04	69	0.88
63	1.01	70	0.86

## Test Method Q306C: Compacted density of asphalt - silicone sealed

### 1 Source

This Test Method was developed in-house using techniques evolved through internal departmental research investigations in Waters TJ (1986) *Void in Asphaltic Concrete*, Report TT99, Materials Branch, Department of Main Roads. It applies the principles of Test Method Q306A-2001: *Compacted Density of Dense Graded Asphalt (Wax Sealed)*.

### 2 Scope

This Test Method describes a procedure for determining the compacted density of asphalt. It is applicable to asphalt samples of all asphalt types either compacted in the laboratory or cut from the pavement. The method is non-destructive and removal of the sealant following testing allows the testing of the sample for other properties.

### 3 Definition

For this Test Method, the following definition shall apply:

- 3.1 Constant mass - when air drying, a sample is considered to have reached a constant mass when the difference between successive determinations of mass, after a further 24 hours drying, is not more than 0.03 percent.

### 4 Apparatus

The following apparatus is required:

- 4.1 Balance, a top pan balance of suitable capacity, with a resolution of at least 0.1 g and with a limit of performance within the range of  $\pm 0.5$  g. Testing in accordance with Subsection 6.2, will require the balance to be capable of below balance weighing.
- 4.2 Balance bench, equipped with a hole for below balance weighing.
- 4.3 Thermometer, a partial or total immersion thermometer or other suitable temperature measuring device having a temperature range which includes the test temperature, and graduated to 1°C or less with an uncertainty of no more than 0.5°C.
- 4.4 Attachment, a non-absorbent device to suspend the asphalt specimen, for example, nylon or wire loop, wire support frame.
- 4.5 Spatula, to apply the sealant to the specimen.
- 4.6 Fan, an electric fan to disperse vapours emanating from the sealant during the curing period.
- 4.7 Water container, fitted with an overflow and of suitable dimensions to allow complete immersion of the specimen without contacting any part of the container (Subsection 6.2 only).
- 4.8 Water container, of sufficient volume to contain the asphalt specimen (Subsection 6.3 only).
- 4.9 Laboratory stand and clamp (Subsection 6.3 only).

### 5 Material

The following material is required:

- 5.1 Sealant, an acetic cure silicone sealant of known density to the nearest 0.001 t/m<sup>3</sup> (Note 9.1).

## 6 Procedure

The procedure shall be as follows:

### 6.1 Sample preparation

6.1.1 For a core sample, prepare in accordance with Test Method Q303A or AS 2891.1.2 Clause 8.

6.1.2 Dry the specimen as follows:

- a) air dry the specimen as appropriate to constant mass (Note 9.2), or
- b) vacuum dry the specimen in accordance with Test Method Q324.

6.1.3 Determine the mass of the specimen ( $m_1$ ).

6.1.4 Apply silicone sealant to approximately one-half of the surface area of the specimen to achieve a smooth and even finish (Note 9.3).

6.1.5 Place the specimen in front of a fan and allow the sealant to cure to a firm and tack-free state.

6.1.6 Apply silicone sealant to the remainder of the specimen to achieve a smooth and even finish (Note 9.3). A guide to the mass of sealant required for different specimen heights, diameters and air voids is given in Table 1.

6.1.7 Allow the sealant to cure (Note 9.4).

6.1.8 Inspect the sealed specimen, apply silicone sealant to any unsealed areas and allow the sealant to cure.

6.1.9 Determine the mass of the sealed specimen ( $m_2$ ).

### 6.2 Density measurement using below balance weighing

6.2.1 Place the container directly below the hole in the balance bench, fill it until water escapes from the overflow and allow the excess water to run to waste.

6.2.2 When water has ceased dripping from the overflow, fit the attachment to the balance, allow the remainder of the attachment to be immersed in the water container, and zero the balance.

6.2.3 Using the attachment, suspend the sealed specimen from the balance and gently lower it into the water container until completely immersed, taking care to ensure that the suspended specimen hangs free of the sides and bottom of the container.

6.2.4 Add additional water if necessary until water escapes from the overflow, and allow the excess water to run to waste.

6.2.5 When water has ceased dripping from the overflow, determine the mass of the immersed sealed specimen ( $m_3$ ).

6.2.6 Record the temperature of the water in the container to the nearest 1°C.

### 6.3 Density measurement using above balance weighing

6.3.1 Add sufficient water to the container to completely immerse the specimen. Place the container and water on the balance and zero the balance.

6.3.2 Position the laboratory stand and clamp so that the clamp is directly above the container on the balance.

6.3.3 Suspend the sealed specimen from the clamp and gently lower it into the water container until completely immersed, taking care to ensure that the suspended specimen hangs free of the sides and bottom of the container.



- 6.3.4 Determine the mass of the immersed sealed specimen and attachment ( $m_3$ ), noting the height of water on the attachment at the time of weighing.
- 6.3.5 Remove the specimen from the water container and zero the balance.
- 6.3.6 With the attachment immersed to the same depth as noted in Step 6.3.4, determine the mass of the suspended attachment ( $m_4$ ).
- 6.3.7 Record the temperature of the water in the container to the nearest 1°C.

## 7 Calculations

Calculations shall be as follows:

### 7.1 Below balance weighing

Calculate the compacted density of the specimen as follows:

$$D_c = \frac{m_1}{\frac{(m_2 - m_3)}{D_w} - \frac{(m_2 - m_1)}{D_s}}$$

- where
- $D_c$  = compacted density of specimen ( $t/m^3$ )
  - $m_1$  = mass of specimen (g)
  - $m_2$  = mass of sealed specimen (g)
  - $m_3$  = mass of immersed sealed specimen (g)
  - $D_w$  = density of water at test temperature ( $t/m^3$ ) (Table 2)
  - $D_s$  = density of silicone sealant ( $t/m^3$ )

### 7.2 Above balance weighing

Calculate the compacted density of the specimen as follows:

$$D_c = \frac{m_1}{\frac{(m_3 - m_4)}{D_w} - \frac{(m_2 - m_1)}{D_s}}$$

- where
- $D_c$  = compacted density of specimen ( $t/m^3$ )
  - $m_1$  = mass of specimen (g)
  - $m_2$  = mass of sealed specimen (g)
  - $m_3$  = mass of immersed sealed specimen and attachment (g)
  - $m_4$  = mass of immersed attachment (g)
  - $D_w$  = density of water at test temperature ( $t/m^3$ ) (Table 2)
  - $D_s$  = density of silicone sealant ( $t/m^3$ )

## 8 Reporting

The following shall be reported:

- 8.1 Compacted density to the nearest 0.001  $t/m^3$ .
- 8.2 The number of this Test Method, that is Q306C.

## 9 Notes on method

- 9.1 Before handling any sealant, the operator should consult the relevant SDS.
- 9.2 A core sample may be assumed to be dry and not require drying to constant mass where:
- The core sample has been taken from the asphalt pavement using Subsection 7.3 (dry coring method) of Test Method AS 2891.1.2, and
  - The asphalt pavement from which the core sample has been taken has remained dry since placement.
- 9.3 During the application of the silicone sealant, it is important that no air is trapped between the silicone sealant layer and the surface of the specimen.
- 9.4 For 100 mm diameter asphalt cores or laboratory manufactured samples, the minimum curing period may be determined from the following expression:

$$C = \frac{(M - 30)}{10} + 0.5$$

where  $C$  = minimum curing time (hours)  
 $M$  = mass of silicone sealant to the nearest 5 g

For 150 mm diameter asphalt cores or laboratory manufactured samples, the minimum curing period for the same mass of sealant will be about 0.54C. For other asphalt samples, the minimum curing period may be estimated from the above expression using relative surface area considerations.

**Table 1 – Guide to the mass of silicone sealant required for test samples**

Sample height (mm)	Mass of silicone sealant (g)					
	Sample air void content (%)			Sample air void content (%)		
	< 5	5-8	> 8	< 5	5-8	> 8
	Sample diameter 100 mm			Sample diameter 150 mm		
≤ 20	20 - 30	30 - 45	40 - 60	55 - 65	65 - 80	75 - 95
21 - 30	25 - 35	35 - 50	45 - 65	60 - 70	70 - 85	80 - 100
31 - 40	30 - 40	40 - 55	50 - 70	70 - 80	80 - 105	90 - 110
41 - 50	35 - 45	45 - 60	55 - 75	75 - 85	85 - 105	95 - 110
51 - 60	40 - 50	50 - 65	60 - 80	85 - 95	95 - 110	105 - 125
61 - 70	45 - 55	55 - 70	65 - 85	90 - 100	100 - 115	110 - 130
71 - 80	50 - 60	60 - 75	70 - 90	100 - 110	110 - 125	120 - 140
81 - 90	55 - 65	65 - 80	75 - 90	105 - 115	115 - 130	125 - 145
91 - 100	60 - 70	70 - 85	80 - 100	115 - 125	125 - 140	135 - 155

**Table 2 – Density of water**

Temperature (°C)	Density (t/m <sup>3</sup> )	Temperature (°C)	Density (t/m <sup>3</sup> )	Temperature (°C)	Density (t/m <sup>3</sup> )
0	0.9998	14	0.9992	28	0.9962
1	0.9999	15	0.9991	29	0.9959
2	0.9999	16	0.9989	30	0.9957
3	1.0000	17	0.9988	31	0.9953
4	1.0000	18	0.9986	32	0.9950
5	1.0000	19	0.9984	33	0.9947
6	0.9999	20	0.9982	34	0.9944
7	0.9999	21	0.9980	35	0.9940
8	0.9999	22	0.9978	36	0.9937
9	0.9998	23	0.9975	37	0.9933
10	0.9997	24	0.9973	38	0.9930
11	0.9996	25	0.9970	39	0.9926
12	0.9995	26	0.9968	40	0.9922
13	0.9994	27	0.9965		

## **Test Method Q306E: Compacted density of asphalt - nuclear gauge**

This test shall be performed in accordance with Test Method N04: *Compacted density of asphalt – nuclear gauge* contained within the department's *Nuclear Gauge Testing Manual*.

## Test Method Q308A: Binder content and aggregate grading of asphalt – reflux method

### 1 Source

This Test Method applies the principles of AS 2891.3.1: *Binder content and aggregate grading - Reflux method*.

### 2 Scope

This Test Method describes the procedure for the determination of the binder content of asphalt by solvent extraction and, subsequently, the particle size distribution of the aggregate by sieve analysis.

### 3 Apparatus

Where appropriate, the working tolerances of apparatus are contained in Table 1.

The following apparatus is required:

#### 3.1 Balances:

- a) balance of suitable capacity, with a resolution of at least 0.1 g and with a limit of performance within the range of  $\pm 0.5$  g, and
- b) balance of suitable capacity, with a resolution of at least 0.001 g and with a limit of performance within the range of  $\pm 0.005$  g.

3.2 Oven of suitable capacity, thermostatically controlled to operate at a temperature of at least 105°C.

3.3 Centrifuge, an electric centrifuge capable of holding at least two 15 mL aliquots.

3.4 Hotplate, capable of maintaining a temperature of 305°C (Note 10.1).

3.5 Fume cupboard.

3.6 Flask, conical flask of 2 L capacity with a ground glass neck of at least 55 mm diameter and fitted with a stopper.

3.7 Condenser, double surface condenser to fit the neck of the flask.

3.8 Beaker, of at least 100 mL capacity.

3.9 Containers, two flat-bottomed aluminium containers of approximate dimensions 100 mm diameter and 75 mm depth and equipped with tightly fitting slip-on lids.

3.10 Metal tray, of sufficient capacity to contain the aggregate.

3.11 Sieves, 37.5 mm, 26.5 mm, 19.0 mm, 13.2 mm, 9.50 mm, 6.70 mm, 4.75 mm, 2.36 mm, 1.18 mm, 0.600 mm, 0.300 mm, 0.150 mm, 0.075 mm and reinforced 0.075 mm as required conforming to ISO 3310.

3.12 Sieve brush.

The following apparatus may be used:

3.13 Mechanical sieve shaker.

## 4 Materials

The following materials are required:

- 4.1 Solvent, toluene commercial grade (Notes 10.2 and 10.3).

The following materials may be used:

- 4.2 Washing solvent such as kerosene, mineral turpentine or similar (Note 10.2).

## 5 Procedure – binder content

The following procedure shall be conducted on a single test portion for asphalt of nominal size less than 20 mm and on two test portions for asphalt of nominal size 20 mm or larger (Note 10.4).

- 5.1 Weigh the flask with stopper and record the mass to the nearest 0.1 g ( $m_1$ ).
- 5.2 If necessary, warm the sample just sufficiently by heating, preferably in the oven, to loosen the mass of material.
- 5.3 Obtain a representative test portion of approximately 1200 g by coning and quartering in accordance with Section 8 of Test Method AS 2891.1.1.
- 5.4 With the flask held at an angle of about 45 degrees, transfer the test portion to the flask and allow it to cool. Weigh the flask with stopper and record the mass to the nearest 0.1 g ( $m_2$ ).
- 5.5 Add a quantity of solvent to the flask at least equivalent in mass to the test portion mass.
- 5.6 Fit the reflux condenser to the flask and gently warm the flask and contents on the hotplate in the fume cupboard to dissolve the binder (Note 10.5). Shake the flask frequently during this refluxing operation to prevent binder from caking on the bottom of the flask.
- 5.7 Allow the flask to cool to room temperature with the condenser still in position. Remove the condenser and fit the stopper.
- 5.8 Weigh the flask and stopper and record the mass to the nearest 0.1 g ( $m_3$ ).
- 5.9 Perform the following procedure on two aliquots:
- 5.9.1 Using the beaker, transfer an aliquot of at least 15 mL of the solution from the flask to the centrifuge tube(s). Stopper the tube(s) immediately and centrifuge to separate any suspended mineral matter.
- 5.9.2 Weigh a container with lid and record the mass to the nearest 0.001 g ( $m_4$ ).
- 5.9.3 Pour the supernatant liquid from the centrifuge tube(s) into the container, taking care not to disturb the settled mineral matter, and fit the lid. Weigh the container immediately and record the mass to the nearest 0.001 g ( $m_5$ ).
- 5.9.4 Remove the lid and place the container on the hotplate maintained at a temperature of  $305 \pm 10^\circ\text{C}$  in the fume cupboard to evaporate the solvent. Continue the heating for two minutes after fumes are first seen to rise from the binder (Notes 10.1 and 10.6).
- 5.9.5 Remove the container from the hotplate, replace the lid and allow the container to cool to room temperature.
- 5.9.6 Weigh the container and lid and record the mass to the nearest 0.001 g ( $m_6$ ).

## 6 Calculations – binder content

Calculations shall be as follows:

6.1 Calculate the binder content based on each aliquot as follows:

$$B_a = \frac{(m_3 - m_2)(m_6 - m_4)100}{(m_5 - m_6)(m_2 - m_1)}$$

where	$B_a$	=	binder content based on one aliquot (%)
	$m_3$	=	mass of flask and stopper, asphalt test portion and solvent (g)
	$m_2$	=	mass of flask and stopper and asphalt test portion (g)
	$m_6$	=	mass of container and lid and binder (g)
	$m_4$	=	mass of container and lid (g)
	$m_5$	=	mass of container and lid and supernatant liquid (g)
	$m_1$	=	mass of flask and stopper (g)

### 6.2 Asphalt of nominal size < 20 mm

6.2.1 Provided the difference between the binder contents based on the two aliquots is less than 0.06%, calculate the binder content of the test portion ( $B$ ) as the mean of the two results. Where the difference between the binder contents based on the two aliquots is 0.06 % or greater, repeat Subsection 5.9.

### 6.3 Asphalt of nominal size ≥ 20 mm

6.3.1 Provided the difference between the binder contents based on the two aliquots from each portion is less than 0.06%, calculate the binder content of each portion as the mean of the two results. Where the difference between the binder contents based on the two aliquots is 0.06 % or greater, repeat Subsection 5.9.

6.3.2 Calculate the binder content of the test portion ( $B$ ) as the mean binder content of the two portions to the nearest 0.01%.

## 7 Procedure – particle size distribution

The procedure shall be as follows:

### 7.1 Load on sieves

Overloading of sieves may affect the accuracy of results and damage the sieves. The maximum loads on sieves at completion of sieving are set out in Table 2. To prevent overloading:

- use sieves with a larger diameter
- use additional sieves, or
- divide the mass retained on the sieve into two or more portions of a mass less than the recommended loading in Table 2 and pass the separate portions through the sieve.

### 7.2 Methods of sieve shaking

7.2.1 Perform sieving by hand or with a mechanical shaker. Material retained on 19 mm or larger sieves may be manipulated by hand.

7.2.2 When conducting sieving by hand, employ a lateral and vertical motion accompanied by a slight jarring action to keep the material moving continuously over the sieve. Particles 19.0 mm or larger may be placed by hand to pass the sieves.

- 7.2.3 When sieving is conducted using a mechanical sieve shaker, sieving is carried out for such time as will give a comparable result to hand sieving, which is generally 12 - 15 minutes.
- 7.2.4 At the end of sieving, hand sieve each portion retained until the mass passing each sieve in one minute is less than 1% of the mass of material retained on that sieve.

### 7.3 Sieving

- 7.3.1 Pour the solution from the flask over the reinforced 0.075 mm sieve and discard the solvent and fines passing the sieve. Retain as much as is possible of the flask's contents in the flask for further washing.
- 7.3.2 Add solvent or a washing solvent to the flask and shake the flask vigorously.
- 7.3.3 Repeat Steps 7.3.1 and 7.3.2 until the test portion is free from binder (Note 10.7).
- 7.3.4 Transfer the bulk of the contents in the flask to the tray, dry on the hotplate and cool to room temperature.
- 7.3.5 Using solvent or washing solvent, transfer any aggregate remaining in the flask to the 0.075 mm reinforced sieve. Dry the aggregate retained on the sieve. Transfer it to the tray using a sieve brush.
- 7.3.6 Pass the contents of the tray through the sieves appropriate to the asphalt type and nominal size.
- 7.3.7 Weigh the aggregate retained on each sieve and record the mass retained ( $m_r$ ) to the nearest 0.1 g. For asphalt of nominal size  $\geq 20$  mm, sum the mass retained on each sieve for each of the two portions and record this combined mass as the individual mass retained.

## 8 Calculations – particle size distribution

Calculations shall be as follows:

### 8.1 Asphalt of nominal size < 20 mm

- 8.1.1 Calculate the total mass of aggregate as follows:

$$m = \frac{(m_2 - m_1)(100 - B)}{100}$$

where  $m$  = total mass of aggregate (g)  
 $m_2$  = mass of flask and asphalt test portion (g)  
 $m_1$  = mass of flask (g)  
 $B$  = binder content of test portion (%)

### 8.2 Asphalt of nominal size $\geq 20$ mm

- 8.2.1 Calculate the mass of each portion as follows:

$$m_d = m_2 - m_1$$

where  $m_d$  = mass of portion (g)  
 $m_2$  = mass of flask and asphalt test portion (g)  
 $m_1$  = mass of flask (g)



8.2.2 Calculate the total mass of test portion as the combined mass of the two portions as follows:

$$m_s = m_{d1} + m_{d2}$$

where  $m_s$  = total mass of test portion (g)

$m_{d1}$  = mass of first portion (g)

$m_{d2}$  = mass of second portion (g)

8.2.3 Calculate the total mass of aggregate as follows:

$$m = \frac{m_s(100 - B)}{100}$$

where  $m$  = total mass of aggregate (g)

$m_s$  = total mass of test portion (g)

$B$  = binder content of test portion (%)

8.3 Calculate the cumulative mass retained on each sieve as follows:

$$M = \sum m_r$$

where  $M$  = cumulative mass retained on a sieve (g)

$m_r$  = individual mass retained on each sieve (g)

8.4 Calculate the cumulative per cent passing each sieve as follows:

$$P_p = 100 - \frac{100M}{m}$$

where  $P_p$  = cumulative percent passing a sieve (%)

$M$  = cumulative mass retained on a sieve (g)

$m$  = total mass of aggregate (g)

## 9 Reporting

The following shall be reported:

### 9.1 Binder content

Report the binder content to the nearest 0.05%.

### 9.2 Particle size distribution

Report the cumulative per cent passing all sieves to the nearest 1% for values 10%, and to the nearest 0.1% for values < 10%.

9.3 The number of this Test Method, that is Q308A.

## 10 Notes on method

10.1 Depending on the type of binder within the test portion and/or container size, it may be necessary to vary the temperature of the hotplate and time of fuming of the binder film. The appropriate hotplate temperature and fuming time can be determined by calibrating against solutions of known binder content.

10.2 Before handling toluene or other solvent, the operator should consult the relevant SDS.

- 10.3 An alternative solvent may be used provided that:
- a) it meets occupational health and safety requirements, and
  - b) it can be demonstrated that use of the solvent achieves equivalent test results.
- 10.4 Asphalt having a nominal size less than 20 mm may also be tested using two test portions. In this case, the calculations of Subsections 6.3 and 8.2 apply.
- 10.5 If the aggregate in the bottom of the flask is clean, then all the binder has been dissolved. If the aggregate retains a coating of binder, then the refluxing should be continued until the aggregate is clean. For mixes containing slag or other absorptive type aggregates, it may be necessary to heat the mixture for periods up to eight hours to extract all traces of absorbed or occluded binder.
- 10.6 Where fumes are not evident within ten seconds of the appearance of a ripple of bubbles across the surface of the binder, continue heating for two minutes from this point.
- 10.7 To enhance drying of the aggregate, acetone may be used in the final washing of the test portion (Note 10.2).

**Table 1 – Working tolerances for apparatus**

Apparatus	Requirement	Tolerance
<b>Hotplate</b>		
Temperature distribution (°C)	305	± 10

**Table 2 – Maximum sieve loading**

Test Sieve (mm)	Maximum loading (g)	
	200 mm diameter	300 mm diameter
37.5	1000	2220
26.5	800	1800
19.0	600	1200
16.0	500	1050
13.2	400	900
9.50	250	600
6.70	230	500
4.75	200	400
2.36	150	300
1.18	100	-
0.600	75	-
0.300	50	-
0.150	40	-
0.075	25	-

## Test Method Q308C: Binder content and aggregate grading of emulsion based cold mix

### 1 Source

This Test Method applies the principles of water content determination described in AS/NZS 2891.10: *Moisture content of asphalt* to the drying of a sample before the determination of binder content and particle size distribution.

### 2 Scope

This Test Method describes the procedure for the determination of the binder content and aggregate grading of cold mix which has been prepared using bituminous emulsion and has negligible volatile oils content, for example, bituminous slurry surfacing. The method involves extraction of residual water in the mix by oven drying and determination of the binder content by solvent extraction and the particle size distribution of the aggregate by sieve analysis.

### 3 Apparatus

The following apparatus is required:

- 3.1 Balance of suitable capacity, with a resolution of at least 0.1 g and with a limit of performance within the range of  $\pm 0.5$  g.
- 3.2 Drying oven of suitable capacity, having a temperature of 105–110°C conforming to AS 1141.2.
- 3.3 Metal tray, of sufficient capacity to contain the test portion.
- 3.4 Spatula.

### 4 Procedure

The procedure shall be as follows:

- 4.1 Obtain a representative test portion that conforms to the minimum mass requirements of AS/NZS 2891.3.1 Table 1 by coning and quartering in accordance with Section 8 of Test Method AS/NZS 2891.1.1.
- 4.2 Place the test portion into the tray and place the tray and test portion into the drying oven and dry to a constant mass.
- 4.3 Using the dry test portion from Step 4.2, determine the binder content and particle size distribution in accordance with either Test Method AS/NZS 2891.3.1, Q308A or AG PT/T234 as appropriate (Note 6.1).

### 5 Reporting

The following shall be reported:

#### 5.1 Binder content

Report the binder content in accordance with Test Method AS/NZS 2891.3.1, Q308A or AG PT/T234 and the Test Method used.

#### 5.2 Particle size distribution

Report the particle size distribution in accordance with Test Method AS/NZS 2891.3.1, Q308A or AG PT/T234 and the Test Method used.

5.3 Include a statement on the report 'Sample dried in 110°C oven before testing'.

5.4 The number of this Test Method, that is Q308C.

## **6 Notes on method**

6.1 If binder drainage occurs during drying, remove the binder from the tray with a spatula and return to the sample before commencing the binder content and particle size distribution testing.

## Test Method Q309: Preparation and testing of asphalt mix

### 1 Source

This Test Method was developed in-house using techniques evolved through internal departmental research investigations into laboratory mix preparation and evaluation.

### 2 Scope

This Test Method describes the procedure for the laboratory preparation and testing of asphalt mix designs. It is applicable to both the design and assessment processes associated with asphalt mix design registration.

### 3 Apparatus

The following apparatus is required:

- 3.1 Mixer, a mechanical mixer comprising a mixing bowl of sufficient capacity to contain an asphalt mix, and an appropriate stirrer that will not cause excessive breakdown of the aggregates and filler. A Hobart dough mixer of 35 L capacity equipped with a heavy-duty wire whip stirrer has been found suitable.
- 3.2 Balance of suitable capacity, with a resolution of at least 1 g and with a limit of performance within the range of  $\pm 5$  g.
- 3.3 Drying oven of suitable capacity, having a temperature of 105 – 110°C and conforming to AS 1289.0.
- 3.4 Oven of suitable capacity and capable of heating a sample of binder to a temperature of 160 - 180°C.
- 3.5 Hotplate.
- 3.6 Heating container, metal container able to be heated to the required temperature (see Step 7.3) and of sufficient capacity to contain the aggregates and added filler.
- 3.7 Heat source, for heating the aggregates and filler to about 220°C where a bitumen binder is to be used, and to about 240°C where a polymer modified binder is to be used, for example gas burner.
- 3.8 Thermometer, a partial immersion thermometer or other suitable temperature measuring device having a temperature range of at least 150 - 250°C and graduated to 1°C or less with an uncertainty of no more than 0.5°C.
- 3.9 Quartering table, a heated metal tray of appropriate dimensions to contain an asphalt mix. A tray of dimensions 750 mm square has been found suitable.
- 3.10 Mixing tools, assorted metal scoops, trowels and spatulas.
- 3.11 Containers, metal or heavy-duty plastic containers of sufficient capacity to contain the aggregate size fractions. Containers of length 420 mm, width 280 mm and height 150 mm have been found suitable.
- 3.12 Sample dividers, riffles with slot widths of approximately 50 mm, 25 mm, 13 mm and 7 mm.
- 3.13 Sieves, 37.5 mm, 26.5 mm, 19.0 mm, 13.2 mm, 9.50 mm, 6.70 mm, 4.75 mm, 2.36 mm, 1.18 mm, 0.600 mm, 0.300 mm, 0.150 mm, 0.075 mm and reinforced 0.075 mm as required conforming to ISO 3310.

- 3.14 Mechanical sieve shaker (optional).
- 3.15 A means for washing the aggregate size fractions.

#### 4 Materials

The following materials are required:

- 4.1 Aggregate components: coarse aggregates, fine aggregates and sand (as appropriate) of the required quantities (see Step 5.6).
- 4.2 Added filler components: fly ash, hydrated lime, baghouse fines or other material of the required quantities (see Step 5.7) (Note 9.1).
- 4.3 Binder: bitumen conforming to MRTS 17, polymer modified binder conforming to MRTS 18 or other specified binder (Note 9.1).
- 4.4 Other components: fibres and additives (where appropriate) (Note 9.1).

#### 5 Preparation of aggregates and added filler

The aggregates and added filler shall be prepared as follows:

- 5.1 Where necessary, dry the aggregate and added filler components comprising the mix design in the oven.
- 5.2 Determine the total quantity of aggregates and filler required for mix preparation (M).
- 5.3 Where RAP is a component of the mix design, determine the grading and binder content of a representative sample of the RAP material in accordance with Test Method AS/NZS 2891.3.1, Q308A, Q308D or AG PT/T234.
- 5.4 Where RAP is a component of the mix design, calculate the quantity of aggregates and filler in the RAP material as follows:

$$M_{RA} = \frac{M P_R (100 - B_R)}{10^4}$$

- where
- $M_{RA}$  = mass of RAP aggregates and filler (g)
  - M = required mass of aggregates and filler (g)
  - $P_R$  = proportion of the RAP component in the mix design (%)
  - $B_R$  = binder content of the RAP component (%)

- 5.5 Calculate the quantity of aggregates and filler required, excluding that in any RAP component, as follows:

$$M_T = M - M_{RA}$$

- where
- $M_T$  = total mass of aggregates and added filler excluding RAP (g)
  - M = required mass of aggregates and filler (g)
  - $M_{RA}$  = mass of RAP aggregates and filler (g)

- 5.6 Calculate the required mass of each aggregate component to the nearest 1 g as follows (Note 9.2):

$$M_A = \frac{P_A M_T}{(100 - P_R)}$$

- where
- $M_A$  = required mass of the aggregate component (g)
  - $P_A$  = proportion of the aggregate component in the mix design (%)
  - $M_T$  = total mass of aggregates and added filler excluding RAP (g)
  - $P_R$  = proportion of the RAP component in the mix design (%)

- 5.7 Calculate the required mass of each added filler component to the nearest 1 g as follows (Note 9.2):

$$M_F = \frac{P_F M_T}{(100 - P_R)}$$

- where
- $M_F$  = required mass of the added filler component (g)
  - $P_F$  = proportion of the added filler component in the mix design (%)
  - $M_T$  = total mass of aggregates and added filler excluding RAP (g)
  - $P_R$  = proportion of the RAP component in the mix design (%)

- 5.8 Obtain the required masses of the aggregate components calculated in Step 5.6 by riffing and then combine these masses into a single sample. Added filler components are not introduced at this stage.
- 5.9 Sieve the combined sample to obtain the size fractions of Table 1 or Table 2 as appropriate using the procedure of Test Method AS/NZS 1141.11.1 and place each sieved size fraction into a separate labelled aggregate container.
- 5.10 Wash each size fraction, excepting the material passing 0.075 mm, over a nest of two sieves comprising a sieve corresponding to the retained size fraction and the reinforced 0.075 mm sieve. Wash each size fraction until the wash water is clear.
- 5.11 Wash, dry and resieve all material retained on the 0.075 mm sieve over the sieves used in Step 5.9 in accordance with Test Method AS/NZS 1141.11.1. Combine and thoroughly mix the material retained on each sieve with the corresponding size fraction obtained in Step 5.10.
- 5.12 Dry each size fraction in the drying oven (Note 9.3).
- 5.13 Determine the particle size distribution of each added filler component in accordance with Test Method AS/NZS 1141.11.1.
- 5.14 Sieve the required mass of each added filler component into the relevant size fractions of Table 1 or Table 2 as appropriate using the procedure of Test Method AS/NZS 1141.11.1 and place each sieved size fraction into a separate labelled filler container.

## 6 Calculation of mix component masses

Calculations shall be as follows:

### 6.1 Aggregates and added filler components

6.1.1 Record the grading of the mix (Note 9.4).

6.1.2 Calculate the percentage in each of the relevant size fractions ( $P_S$ ) of Table 1 or Table 2 as appropriate for the mix grading.

6.1.3 Calculate the required mass of each added filler component for each size fraction to the nearest 1 g as follows:

$$M_{FS} = \frac{P_{FS}M_F}{100}$$

where  $M_{FS}$  = required mass of added filler size fraction (g)

$P_{FS}$  = proportion in the size fraction for the added filler determined from Step 5.13 (%)

$M_F$  = required mass of added filler calculated in Step 5.7 (g)

6.1.4 Calculate the total mass of added filler ( $M_{FST}$ ) for each size fraction by summing the relevant  $M_{FS}$  values for all added filler components.

6.1.5 Calculate the required masses of each aggregate size fraction to the nearest 1 g as follows (Note 9.5):

$$M_{AS} = \frac{P_S M_T}{100} - M_{FST} - \frac{M_{RA} P_{RS}}{100}$$

where  $M_{AS}$  = required mass of aggregate size fraction (g)

$P_S$  = proportion in the size fraction calculated in Step 6.1.2 (%)

$M_T$  = total mass of aggregate and added filler in the mix (g)

$M_{FST}$  = total mass of added filler for the size fraction (g)

$M_{RA}$  = mass of RAP aggregates and filler calculated in Step 5.4 (g)

$P_{RS}$  = proportion in the size fraction for the RAP material determined from Step 5.3 (%)

### 6.2 Binder

Record the design binder content of the mix. Where required for dense graded asphalt, calculate the high and low tolerance binder contents by applying the appropriate maximum permitted variations of Table 3 to the design binder content.

## 7 Preparation of mix

The mix shall be prepared as follows:

7.1 Prepare the mixing bowl as follows:

7.1.1 Following use of the bowl in mixing aggregate, filler and binder components, empty the bowl and scrape adhering fines from the mixing area within the bowl while allowing a thin coating of binder to remain on the inside surface of the bowl.



- 7.1.2 Preheat the mixing bowl on the hotplate or in the oven.
- 7.2 Weigh the required masses of each size fraction calculated in Steps 6.1.3 and 6.1.5 for a particular mix into the heating container.
- 7.3 Heat the container and contents to the appropriate temperature (Table 4). During the heating process, mix the contents periodically using the scoop to provide an even temperature distribution (Note 9.6).
- 7.4 Heat sufficient binder (and RAP material where applicable) for the mix in the oven to the appropriate temperature (Table 4).
- 7.5 Weigh the heated mixing bowl and record the mass ( $m_1$ ) to the nearest 1 g.
- 7.6 Remove the container from the heat source and empty the contents carefully into the mixing bowl, ensuring that any fines adhering to the container are returned to the mix by brushing.
- 7.7 With the contents of the mixing bowl at the appropriate temperature (Table 4), weigh the mixing bowl and contents and record the mass ( $m_2$ ) to the nearest 1 g.
- 7.8 Where RAP is a component of the mix design, calculate the required mass of RAP material for the mix to the nearest 1 g as follows:

$$M_R = \frac{P_R(m_2 - m_1)}{(100 - P_R)}$$

- where  $M_R$  = required mass of RAP material (g)  
 $P_R$  = proportion of RAP in the mix (%)  
 $m_2$  = mass of mixing bowl and contents (g)  
 $m_1$  = mass of mixing bowl (g)

- 7.9 Remove the RAP material from the oven and add the required mass of representative RAP material ( $M_R$ ) to the mixing bowl.
- 7.10 Using a scoop or trowel, thoroughly stir the contents of the mixing bowl and then form a crater in the centre of the contents of the mixing bowl.
- 7.11 Calculate the required mass of binder for the mix to the nearest 1 g as follows:

$$M_B = \frac{P_B(m_2 - m_1)}{100 - P_B} - \frac{B_R M_R}{100}$$

- where  $M_B$  = required mass of binder (g)  
 $P_B$  = proportion of binder in the mix design (%)  
 $m_2$  = mass of mixing bowl and contents (g)  
 $m_1$  = mass of mixing bowl (g)  
 $B_R$  = binder content of the RAP material (%)  
 $M_R$  = required mass of RAP material (g)

For stone mastic asphalt, add the fibre component of the mix to the heated contents of the mixing bowl immediately prior to addition of the binder. Where a bituminous pelletised fibre is used, adjust the quantity of binder added to the mix to allow for the binder contribution from the fibre.

- 7.12 Remove the binder from the oven, stir the binder and pour the required mass of binder ( $M_B$ ) into the crater.
- 7.13 Mechanically mix the contents of the mixing bowl for 90 seconds at the slowest speed.
- 7.14 Stop the mixer and return any binder rich fines adhering to the stirrer and walls of the mixing bowl to the mix by scraping with the trowel or spatula.
- 7.15 Mechanically mix the contents of the mixing bowl for a further 90 seconds at the slowest speed.
- 7.16 Transfer the mix from the mixing bowl to the quartering table. Return any material adhering to the stirrer and mixing bowl to the mix by scraping with the trowel or spatula.
- 7.17 Obtain representative portions of the mix in accordance with Section 8 of Test Method AS/NZS 2891.1.1 and prepare test specimens in accordance with Section 5 of Test Method Q305, two for DG28 mix and four for all other mixes.
- 7.18 Remove any lip formed around the edges of each test specimen without damage to the test specimen.
- 7.19 Determine the compacted density of each test specimen in accordance with Test Method Q306C.
- 7.20 Where required, determine the stability, flow and stiffness of the test specimens in accordance with Test Method Q305.
- 7.21 Where required for open graded asphalt and stone mastic asphalt, prepare a 2 kg sample of mix in accordance with Steps 7.1 to 7.16 and test the mix for binder drainage in accordance with Test Method Q310.
- 7.22 Where required for open graded asphalt, test the four specimens for abrasion loss in accordance with Test Method AG:PT/T236.
- 7.23 Prepare a 2 kg sample of mix in accordance with Steps 7.1 to 7.16 and determine the maximum density in accordance with Test Method AS/NZS 2891.7.1 or Q307A.
- 7.24 Where required (excepting open graded asphalt), combine the mix from all test specimens, dry the mix, obtain a representative sample of the combined mix and determine the binder content and grading of the sample in accordance with Test Method AS/NZS 2891.3.1, Q308A, Q308D or AG PT/T234.
- 7.25 Using the corresponding compacted density and maximum density values for each test specimen, determine the air voids for each test specimen in accordance with Test Method Q311.
- 7.26 Calculate the average air voids and average compacted density for the test specimens and determine the remaining voids properties for the mix in accordance with Test Method Q311.
- 7.27 For tolerance mixes, if the test results for the mix meet the specified requirements within the maximum testing variation limits of Table 5), the mix shall be deemed to comply.

## **8 Reporting**

- 8.1 Report all test results obtained for the mix and the number of this Test Method, that is Q309.

## **9 Notes on method**

- 9.1 Before handling fillers, binders, fibres and additives, the operator should consult the relevant SDS.

- 9.2  $M_T$  should normally be about 50 kg for asphalt nominal size < 20 mm and about 70 kg for asphalt nominal size  $\geq$  20 mm.
- 9.3 The time required to dry the size fractions in the 105-110°C oven will be dependent on the properties of the aggregate. Drying overnight will normally be sufficient, although longer drying periods may be required for aggregates having high water absorption values.
- 9.4 Where a tolerance mix is to be prepared for dense graded asphalt, calculate the coarse and/or fine gradings by applying the appropriate maximum permitted variations of Table 3) to the design grading.
- 9.5 Some breakdown of the aggregates in the mix may occur during the mixing process. Where this breakdown is significant for aggregates, an appropriate reduction in the calculated mass of aggregate for the percentage passing 0.075 mm may be necessary.
- 9.6 Mixing for 30 seconds following each 15 minute heating period has been found adequate.

**Table 1 – Size fractions for dense graded asphalt**

Sieve size (mm)	Size fraction (mm)				
	DG7	DG10	DG14	DG20	DG28
37.5	–	–	–	–	37.5–26.5
26.5	–	–	–	26.5–19.0	26.5–19.0
19.0	–	–	19.0–13.2	19.0–13.2	19.0–13.2
13.2	–	13.2–9.50	13.2–9.50	13.2–9.50	13.2–9.50
9.50	9.50–6.70	9.50–6.70	9.50–4.75	9.50–4.75	9.50–4.75
6.70	6.70–4.75	6.70–4.75	–	–	–
4.75	4.75–2.36	4.75–2.36	4.75–2.36	4.75–2.36	4.75–2.36
2.36	2.36–1.18	2.36–1.18	2.36–1.18	2.36–1.18	2.36–1.18
1.18	1.18–0.600	1.18–0.600	1.18–0.600	1.18–0.600	1.18–0.600
0.600	0.600–0.300	0.600–0.300	0.600–0.300	0.600–0.300	0.600–0.300
0.300	0.300–0.150	0.300–0.150	0.300–0.150	0.300–0.150	0.300–0.150
0.150	0.150–0.075	0.150–0.075	0.150–0.075	0.150–0.075	0.150–0.075
0.075	< 0.075	< 0.075	< 0.075	< 0.075	< 0.075

**Table 2 – Size fractions for stone mastic and open graded asphalt**

Sieve size (mm)	Size fraction (mm)			
	SM10	SM14	OG10	OG14
19.0	–	19.0–13.2	–	19.0–13.2
13.2	13.2–9.50	13.2–9.50	13.2–9.50	13.2–9.50
9.50	9.50–6.70	9.50–6.70	9.50–6.70	9.50–6.70
6.70	6.70–4.75	6.70–4.75	6.70–4.75	6.70–4.75
4.75	4.75–2.36	4.75–2.36	4.75–2.36	4.75–2.36
2.36	2.36–1.18	2.36–1.18	2.36–1.18	2.36–1.18

Sieve size (mm)	Size fraction (mm)			
	SM10	SM14	OG10	OG14
1.18	1.18–0.600	1.18–0.600	1.18–0.300	1.18–0.300
0.600	0.600–0.300	0.600–0.300	–	–
0.300	0.300–0.150	0.300–0.150	0.300–0.075	0.300–0.075
0.150	0.150–0.075	0.150–0.075	–	–
0.075	< 0.075	< 0.075	< 0.075	< 0.075

**Table 3 – Maximum permitted variation for dense graded asphalt**

Sieve size (mm)	Variation (% by mass)	Sieve size (mm)	Variation (% by mass)
≥ 9.50	±7	0.600	±4
6.70	±6	0.300	±3
4.75	±6	0.150	±2
2.36	±5	0.075	±1
1.18	±4		
<b>Binder content (%)</b>		± 0.3*	

\* May be tightened to achieve specification compliance

**Table 4 – Temperatures for laboratory mix production**

Component	Asphalt type	Temperature (°C)*	
		Component	Mixing bowl
Class 320 bitumen	Dense graded, stone mastic	160–170	210–230
Class 320 bitumen	Open graded	160–170	180–190
Class 600 bitumen	Dense graded	160–170	210–230
Multigrade bitumen	Dense graded	160–170	210–230
A5S polymer modified binder	Dense graded, stone mastic	170–180	230–250
A5S polymer modified binder	Open graded	170–180	200–210
Reclaimed asphalt pavement	Dense graded	160–170	210–230

\* For binders other than those listed, the appropriate temperatures may be interpolated/extrapolated based on binder viscosities

**Table 5 – Maximum testing variations for dense graded asphalt tolerance mixes**

<b>Test method</b>	<b>Property</b>	<b>Maximum testing variation</b>
Q305	Stability (kN)	$\pm 0.3$
	Flow (mm)	$\pm 0.1$
	Stiffness (kN/mm)	$\pm 0.1$
Q311	Air voids (%)	$\pm 0.2$
	Voids in mineral aggregate (%)	$\pm 0.3$
	Voids filled with binder (%)	$\pm 0.9$

## Test Method Q311: Voids properties for compacted asphalt

### 1 Source

This Test Method applies the principles of AS/NZS 2891.8: *Voids and volumetric properties of compacted asphalt mixes*. It differs from this Australian Standard in that binder absorption is determined either directly or indirectly from water absorption as well as via calculation from values of aggregate particle density, binder density and asphalt maximum density.

### 2 Scope

This Test Method describes the procedure for calculation of the voids relationships for a specimen of compacted asphalt. It requires prior determination of the compacted density, maximum density and binder content of the sample, the density of the binder and the binder absorption of the aggregate.

### 3 Procedure

The procedure shall be as follows:

- 3.1 Determine either the compacted density of the specimen ( $D_C$ ) in accordance with Test Method Q306C, Q306D or Q306E as appropriate, or the bulk density of the specimen ( $D_C$ ) in accordance with Test Method AS/NZS 2891.9.2 or AS/NZS 2891.9.3 as appropriate and record the value to the nearest 0.001 t/m<sup>3</sup>.
- 3.2 Determine the maximum density of the sample ( $D_M$ ) in accordance with Test Method AS/NZS 2891.7.1 and record the value to the nearest 0.001 t/m<sup>3</sup>.
- 3.3 Determine the binder content of the sample ( $B$ ) in accordance with Test Method AS/NZS 2891.3.1, AG:PT/T234 or Q308A as appropriate and record the value to the nearest 0.01%.
- 3.4 Determine the density of the binder in the sample ( $D_B$ ) in accordance with Test Method AS 2341.7 and record the value at 25°C to the nearest 0.001 t/m<sup>3</sup> (Note 6.1).
- 3.5 Determine the binder absorption of the aggregate ( $b_m$ ) in accordance with Test Method Q211, or using an established binder absorption / water absorption relationship as appropriate, or the binder absorbed of the aggregate ( $b$ ) in accordance with Test Method AS/NZS 2891.8. Record the value of binder absorption or binder absorbed to the nearest 0.01% (Notes 6.2, 6.3 and 6.4). Where binder absorption is determined using a binder absorption/water absorption relationship, determine the water absorption of the coarse fraction (retained 4.75 mm) ( $WA_C$ ) and fine fraction (passing 4.75 mm and retained 0.075 mm) ( $WA_f$ ) in accordance with Test Methods AS 1141.6.1 and AS 1141.5 respectively and record these values to the nearest 0.01%.

### 4 Calculations

Calculations shall be as follows:

- 4.1 Calculate the percentage by volume of air voids in the specimen as follows:

$$V_a = 100 \left( 1 - \frac{D_C}{D_M} \right)$$

- where
- $V_a$  = air voids (%)
  - $D_C$  = compacted density / bulk density of the specimen (t/m<sup>3</sup>)
  - $D_M$  = maximum density of the sample (t/m<sup>3</sup>)

4.2 Calculate the percentage by volume of effective binder in the specimen using the appropriate calculation as follows (Note 6.4):

4.2.1 For binder absorption of the aggregate determined using Test Method Q211 or an established binder absorption/water absorption relationship:

$$V_B = \frac{D_C}{D_B} \left( B - b_a + \frac{B b_a}{100} \right)$$

where  $V_B$  = effective binder volume (%)  
 $D_C$  = compacted density / bulk density of the specimen (t/m<sup>3</sup>)  
 $D_B$  = density of the binder (t/m<sup>3</sup>)  
 $B$  = binder content of the sample (%)  
 $b_a$  = binder absorption of the aggregate (% by mass of aggregate)

4.2.2 For binder absorption of the aggregate determined using Test Method AS/NZS 2891.8:

$$V_B = \frac{D_C}{D_B} f(B - b_m)$$

where  $V_B$  = effective binder volume (%)  
 $D_C$  = compacted density / bulk density of the specimen (t/m<sup>3</sup>)  
 $D_B$  = density of the binder (t/m<sup>3</sup>)  
 $B$  = binder content of the sample (%)  
 $b_m$  = binder absorption of the aggregate (% by mass of mix)

4.3 Calculate the percentage by volume of voids in the mineral aggregate in the specimen as follows:

$$VMA = V_a + V_B$$

where  $VMA$  = voids in the mineral aggregate (%)  
 $V_a$  = air voids (%)  
 $V_B$  = effective binder volume (%)

4.4 Calculate the percentage by volume of voids filled with binder in the specimen as follows:

$$VFB = \frac{100V_B}{VMA}$$

where  $VFB$  = voids filled with binder (%)  
 $V_B$  = effective binder volume (%)  
 $VMA$  = voids in the mineral aggregate (%)

4.5 When performing tests on a lot, calculate the maximum and minimum characteristic percentage by volume of air voids in accordance with Test Method Q020.

## 5 Reporting

The following shall be reported:

- 5.1 Air voids to the nearest 0.1%, and
- 5.2 The number of this Test Method, that is Q311.

The following may be reported:

- 5.3 Voids in the mineral aggregate to the nearest 0.1%.
- 5.4 Voids filled with binder to the nearest 0.5%.
- 5.5 Effective binder volume to the nearest 0.1%.
- 5.6 The minimum characteristic percentage by volume of air voids in accordance with Test Method Q020.
- 5.7 The maximum characteristic percentage by volume of air voids in accordance with Test Method Q020.

## 6 Notes on method

- 6.1 Where the density of the binder is unknown and circumstances do not allow its determination, assume a value of 1.040 t/m<sup>3</sup>.
- 6.2 Where the binder absorption of the aggregate in the sample is to be obtained using Test Method Q211 but is known from previous determination, further testing in accordance with Q211 is unnecessary.
- 6.3 Where the binder absorption of the aggregate in the sample is to be obtained using an established binder absorption/water absorption relationship, the following calculation may be used:

$$b_a = 0.55WA$$

where  $b_a$  = binder absorption of the aggregate (% by mass of aggregate)  
 $WA$  = water absorption of the aggregate (%)

$WA$  may be calculated using either of the following that assume the filler component to have an absorption value equivalent to the mean of the coarse and fine aggregate absorption values.

- a) Where water absorption values are available for the coarse and fine fractions of the combined aggregate, calculate the water absorption of the aggregate as follows.

$$WA = \frac{P_c WA_c + P_f WA_f}{P_c + P_f}$$

where  $WA$  = water absorption of the aggregate (%)  
 $P_c$  = proportion of coarse aggregate (%)  
 $WA_c$  = water absorption of coarse aggregate (%)  
 $P_f$  = proportion of fine aggregate (%)  
 $WA_f$  = water absorption of fine aggregate (%)



- b) Where water absorption values are available for the coarse and fine fractions of each individual aggregate component of the combined aggregate, calculate the water absorption as follows:

$$WA = \sum_{i=1}^n P_i WA_i$$

where  $WA$  = water absorption of the aggregate (%)

$P_i$  = proportion of the  $i^{\text{th}}$  aggregate component in the combined aggregate (%)

$WA_i$  = water absorption of  $i^{\text{th}}$  aggregate component calculated using Test Method AS 1141.6.1 (%)

$n$  = number of aggregate components

- 6.4 Where binder absorption of the aggregate is determined using Test Method Q211 or an established binder absorption/water absorption relationship, it is expressed as a percentage by mass of aggregate. To convert from percentage by mass of aggregate to percentage by mass of mix, the following calculation may be used:

$$b_m = b_a - \frac{B b_a}{100}$$

where  $b_m$  = binder absorption of the aggregate (% by mass of mix)

$b_a$  = binder absorption of the aggregate (% by mass of aggregate)

$B$  = binder content of the sample (%)

Figure 1 — Relationship of volumetric properties of compacted asphalt

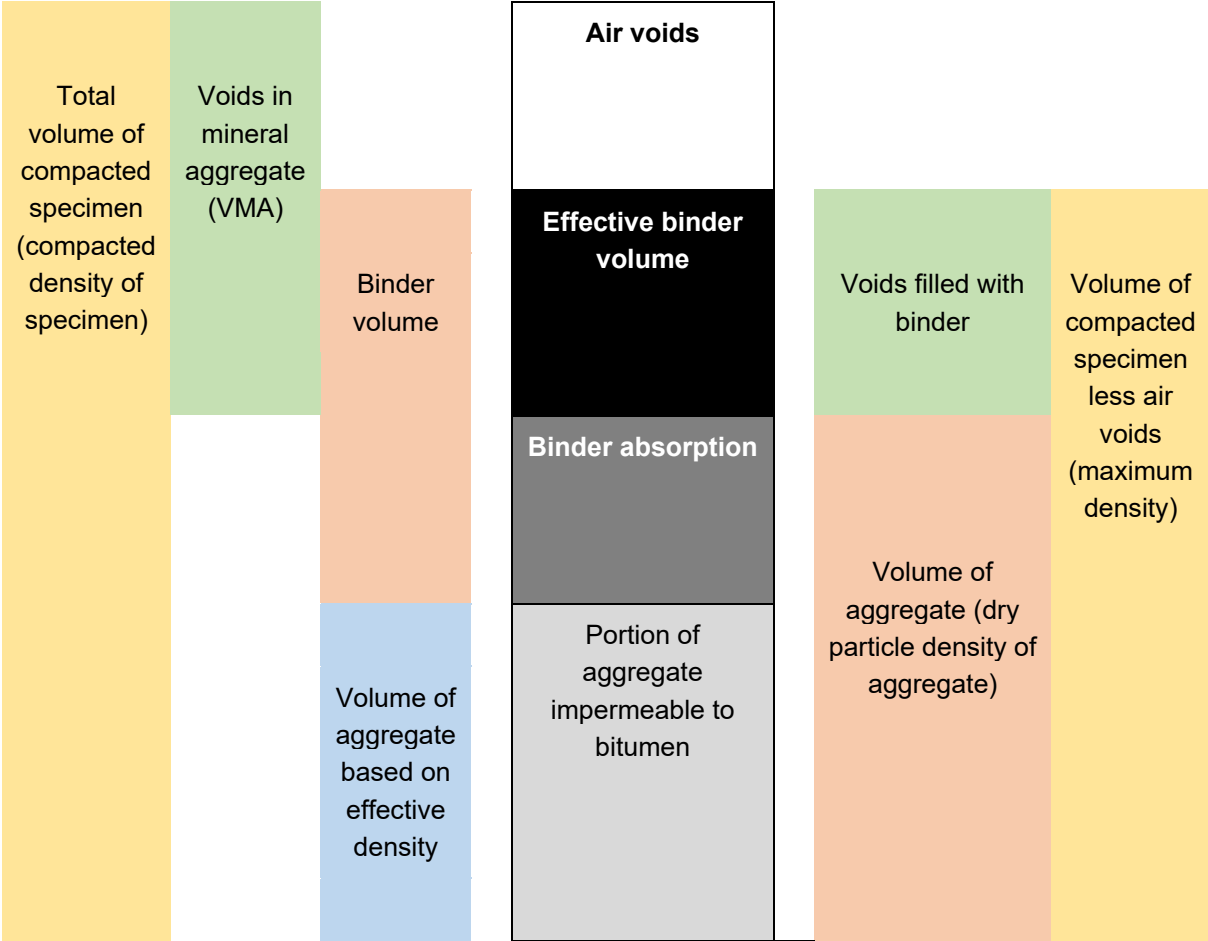

## Test Method Q317: Binder film index of asphalt

### 1 Source

This Test Method applies the principles of Austroads Test Method AG:PT/T237: *Binder film index*.

### 2 Scope

This Test Method sets out a procedure for calculation of the binder film index of a sample of asphalt. It requires prior determination of the binder content and aggregate grading of the sample, density of the binder, binder absorption of the aggregate, particle density on a dry basis of the coarse aggregate and fine aggregate, apparent particle density of the filler and the proportions of coarse aggregate, fine aggregate and filler in the combined aggregate of the sample.

### 3 Procedure

The procedure shall be as follows:

- 3.1 Determine the particle density on a dry basis of the coarse aggregate (retained 4.75 mm) ( $\rho_c$ ) in accordance with Test Method AS 1141.6.1.
- 3.2 Determine the particle density on a dry basis of the fine aggregate (passing 4.75 mm and retained 0.075 mm) ( $\rho_f$ ) in accordance with Test Method AS 1141.5.
- 3.3 Determine the apparent particle density of the filler (passing 0.075 mm) ( $\rho_{fill}$ ) in accordance with Test Method AS/NZS 1141.7 and record the value to the nearest 0.001 t/m<sup>3</sup>.
- 3.4 Determine the proportions of coarse aggregate (retained 4.75 mm) ( $P_c$ ), fine aggregate (passing 4.75 mm and retained 0.075 mm) ( $P_f$ ) and filler (passing 0.075 mm) ( $P_{fill}$ ) in the combined mineral aggregate and record these values to the nearest 0.1%.
- 3.5 Determine the binder content and aggregate grading of the asphalt sample in accordance with Test Methods AS/NZS 2891.3.1, Q308A or AG:PT/T234 as appropriate and record the binder content value ( $B$ ) to the nearest 0.01%.
- 3.6 Determine the binder absorption of the aggregate ( $b_m$ ) in accordance with Test Method Q211 or using an established binder absorption / water absorption relationship as appropriate, or the binder absorbed of the aggregate ( $b$ ) in accordance with Test Method AS/NZS 2891.8. Record the value of binder absorption or binder absorbed to the nearest 0.01% (Notes 6.1, 6.2 and 6.3). Where binder absorption is determined using a binder absorption/water absorption relationship, determine the water absorption of the coarse fraction (retained 4.75 mm) ( $WA_c$ ) and fine fraction (passing 4.75 mm and retained 0.075 mm) ( $WA_f$ ) in accordance with Test Methods AS 1141.6.1 and AS 1141.5 respectively and record these values to the nearest 0.01%.
- 3.7 Determine the density of the binder in the sample ( $D_B$ ) in accordance with Test Method AS 2341.7 and record the value at 25°C to the nearest 0.001 t/m<sup>3</sup> (Note 6.4).

## 4 Calculations

Calculations shall be as follows:

- 4.1 Calculate the particle density of the combined aggregate as follows:

$$\rho_a = \frac{100}{\frac{P_c}{\rho_c} + \frac{P_f}{\rho_f} + \frac{P_{fill}}{\rho_{fill}}}$$

where	$\rho_a$	=	particle density of combined aggregate (t/m <sup>3</sup> )
	$P_c$	=	proportion of coarse aggregate (%)
	$\rho_c$	=	particle density of coarse aggregate on a dry basis (t/m <sup>3</sup> )
	$P_f$	=	proportion of fine aggregate (%)
	$\rho_f$	=	particle density of fine aggregate on a dry basis (t/m <sup>3</sup> )
	$P_{fill}$	=	proportion of filler (%)
	$\rho_{fill}$	=	apparent particle density of filler (t/m <sup>3</sup> )

- 4.2 Calculate the surface area factor for the combined aggregate as follows:

$$A = 0.20482(2 + 0.02a + 0.04b + 0.08c + 0.14d + 0.30e + 0.60f + 1.60g)$$

where	$A$	=	surface area factor
	$a$	=	proportion passing 4.75 mm (%)
	$b$	=	proportion passing 2.36 mm (%)
	$c$	=	proportion passing 1.18 mm (%)
	$d$	=	proportion passing 0.600 mm (%)
	$e$	=	proportion passing 0.300 mm (%)
	$f$	=	proportion passing 0.150 mm (%)
	$g$	=	proportion passing 0.075 mm (%)

- 4.3 Calculate the effective binder content of the sample using the appropriate calculation as follows:

- 4.3.1 For binder absorption of the aggregate determined using Test Method Q211 or an established binder absorption / water absorption relationship:

$$B_e = B - b_m$$

where	$B_e$	=	effective binder content of the sample (%)
	$B$	=	binder content of the sample (%)
	$b_m$	=	binder absorption of the aggregate (% by mass of mix)

4.3.2 For binder absorbed of the aggregate determined using Test Method AS/NZS 2891.8:

$$B_e = B - b$$

where  $B_e$  = effective binder content of the sample (%)  
 $B$  = binder content of the sample (%)  
 $b$  = proportion by mass of binder absorbed (%)

4.4 Calculate the binder film index of the sample as follows:

$$T_F \frac{\rho_a B_e 10^3}{2.65 D_B (100 - B) A}$$

where  $T_F$  = binder film index  
 $\rho_a$  = particle density of combined aggregate (t/m<sup>3</sup>)  
 $B_e$  = effective binder content of the sample (%)  
 $B$  = binder content of the sample (%)  
 $D_B$  = density of the binder (t/m<sup>3</sup>)  
 $A$  = surface area factor for the combined aggregate

## 5 Reporting

The following shall be reported:

- 5.1 Report binder film index to the nearest 0.1.
- 5.2 The number of this Test Method, that is Q317.

## 6 Notes on method

- 6.1 Where the binder absorption of the aggregate in the sample is to be obtained using Test Method Q211 but is known from previous determination, further testing in accordance with Q211 is unnecessary.
- 6.2 Where the binder absorption of the aggregate in the sample is to be obtained using an established binder absorption/water absorption relationship, the following calculation may be used. This assumes the filler component to have an absorption value equivalent to the mean of the coarse and fine aggregate absorption values.

$$b_a = \frac{0.55(P_c W A_c + P_f W A_f)}{P_c + P_f}$$

where  $b_a$  = binder absorption of the aggregate (% by mass of aggregate)  
 $P_c$  = proportion of coarse aggregate (%)  
 $W A_c$  = water absorption of coarse aggregate (%)  
 $P_f$  = proportion of fine aggregate (%)  
 $W A_f$  = water absorption of fine aggregate (%)

- 6.3 Where binder absorption of the aggregate is determined using Test Method Q211 or an established binder absorption/water absorption relationship, it is expressed as a percentage by mass of aggregate. To convert from percentage by mass of aggregate to percentage by mass of mix, the following calculation may be used:

$$b_m = b_a - \frac{B b_a}{100}$$

- where
- $b_m$  = binder absorption of the aggregate (% by mass of mix)
  - $b_a$  = binder absorption of the aggregate (% by mass of aggregate)
  - $B$  = binder content of the sample (%)

- 6.4 Where the density of the binder is unknown and circumstances do not allow its determination, a value of 1.040 t/m<sup>3</sup> may be assumed.

## Test Method Q318: Mix volume ratio of stone mastic asphalt

### 1 Source

This Test Method was developed in-house using information contained within technical references.

### 2 Scope

This Test Method describes the procedure for calculation of the mix volume ratio for SM14 and SM10 stone mastic asphalt. This ratio is defined as the volume of the components other than the coarse aggregate within a compacted mix expressed as a proportion of the volume of air voids contained within the coarse aggregate in a dry rodded condition. The coarse aggregate is defined as the fraction retained 4.75 mm for SM14 mix, and 2.36 mm for SM10 mix. The method requires determination of the binder content and grading of the mix, the particle density on a dry basis of the coarse aggregate, the compacted unit mass of the coarse aggregate and the compacted density of the mix.

### 3 Procedure

The procedure shall be as follows:

- 3.1 Determine the total binder content ( $B$ ) and aggregate grading of the mix in accordance with Test Methods AS/NZS 2891.3.1, Q308A or AG:PT/T234 as appropriate. Record the proportion of coarse aggregate in the total aggregate ( $P_c$ ) to the nearest 0.1%.
- 3.2 Determine the particle density on a dry basis of the coarse aggregate ( $\rho_D$ ) in accordance with Test Method AS 1141.6.1.
- 3.3 Determine the mean compacted bulk density of the coarse aggregate ( $P_c$ ) in accordance with Test Method AS 1141.4 with the exception that the test shall be performed in triplicate and the mean compacted bulk density shall be recorded to the nearest 0.001 t/m<sup>3</sup>.
- 3.4 Determine the compacted density of the mix ( $D_c$ ) in accordance with Test Method Q306C and record the value to the nearest 0.001 t/m<sup>3</sup>.

### 4 Calculations

Calculations shall be as follows:

- 4.1 Calculate the volume of coarse aggregate in the mix using as follows:

$$V_c = \frac{P_c D_c (100 - B)}{100 \rho_D}$$

where	$V_c$	=	volume of coarse aggregate in the mix (%)
	$P_c$	=	proportion of coarse aggregate in the total aggregate (%)
	$D_c$	=	compacted density of the mix (t/m <sup>3</sup> )
	$B$	=	total binder content of the mix (%)
	$\rho_D$	=	particle density on a dry basis of the coarse aggregate (t/m <sup>3</sup> )

4.2 Calculate the void volume in the compacted coarse aggregate using as follows:

$$V_v = 100 \left( 1 - \frac{\rho_c}{\rho_D} \right)$$

- where
- $V_v$  = void volume in the compacted coarse aggregate in the dry rodded condition (%)
  - $\rho_c$  = mean compacted bulk density of the coarse aggregate ( $t/m^3$ )
  - $\rho_D$  = particle density on a dry basis of the coarse aggregate ( $t/m^3$ )

4.3 Calculate the mix volume ratio for the mix as follows:

$$MVR = \frac{100 - V_c}{V_v}$$

- where
- $MVR$  = mix volume ratio
  - $V_c$  = volume of coarse aggregate in the mix (%)
  - $V_v$  = void volume in the compacted coarse aggregate (%)

## 5 Reporting

The following shall be reported:

- 5.1 Report the mix volume ratio to the nearest 0.01.
- 5.2 The number of this Test Method, that is Q318.



## Test Method Q321: Fixed and free binder in asphalt

### 1 Source

This Test Method was developed in-house using measures evolved through internal departmental research investigations.

### 2 Scope

This Test Method sets out a procedure for calculation of the fixed and free binder in a sample of asphalt. Fixed binder represents that portion of the binder that is immobilised by the filler. Free binder represents that portion of the binder that is neither absorbed by the aggregate nor immobilised by the filler. Prior determination is required of the compacted density of the specimen and the binder content, density of the binder, binder absorption of the aggregate, apparent particle density and voids of the combined filler, and the proportion of combined filler in the sample.

### 3 Procedure

The procedure shall be as follows:

- 3.1 Determine the binder content of the sample ( $B$ ) in accordance with Test Methods AS/NZS 2891.3.1, Q308A or AG:PT/T234 as appropriate and record the value to the nearest 0.01%.
- 3.2 Determine the binder absorption of the aggregate ( $b_m$ ) in accordance with Test Method Q211, or using an established binder absorption / water absorption relationship as appropriate, or the binder absorbed of the aggregate ( $b$ ) in accordance with Test Method AS/NZS 2891.8. Record the value of binder absorption or binder absorbed to the nearest 0.01% (Notes 6.1, 6.2 and 6.3). Where binder absorption is determined using a binder absorption / water absorption relationship, determine the water absorption of the coarse fraction (retained 4.75 mm) ( $WA_c$ ) and fine fraction (passing 4.75 mm and retained 0.075 mm) ( $WA_f$ ) in accordance with Test Methods AS 1141.6.1 and AS 1141.5 respectively, and record these values to the nearest 0.01%.
- 3.3 Determine the density of the binder in the sample ( $D_B$ ) in accordance with Test Method AS 2341.7 and record the value at 25°C to the nearest 0.001 t/m<sup>3</sup> (Note 6.4).
- 3.4 Determine the compacted density of the specimen ( $D_C$ ) in accordance with Test Methods AS/NZS 2891.9.2 or Q306C as appropriate and record the value to the nearest 0.001 t/m<sup>3</sup>.
- 3.5 Determine the proportion of the combined filler ( $P_{fill}$ ) as a percentage of the total aggregate and filler in the sample and record the value to the nearest 0.1%.
- 3.6 Determine the apparent particle density of the combined filler ( $\rho_{fill}$ ) in accordance with Test Method AS/NZS 1141.7 and record the value to the nearest 0.001 t/m<sup>3</sup>.
- 3.7 Determine the voids in dry compacted filler for the combined filler ( $V$ ) in accordance with Test Method AS/NZS 1141.17 and record the value to the nearest 0.1%.

## 4 Calculations

Calculations shall be as follows:

4.1 Calculate the percentage by volume of effective binder in the specimen using the appropriate calculation as follows (Note 6.4):

4.1.1 For binder absorption of the aggregate determined using Test Method Q211 or an established binder absorption / water absorption relationship:

$$V_B = \frac{D_C}{D_B} \left[ B - \left( b_a - \frac{B b_a}{100} \right) \right]$$

where	$V_B$	=	effective binder volume (%)
	$D_C$	=	compacted density / bulk density of the specimen (t/m <sup>3</sup> )
	$D_B$	=	density of the binder (t/m <sup>3</sup> )
	$B$	=	binder content of the sample (%)
	$b_a$	=	binder absorption of the aggregate (% by mass of aggregate)

4.1.2 For binder absorption of the aggregate determined using Test Method AS/NZS 2891.8:

$$V_B = \frac{D_C}{D_B} (B - b)$$

where	$V_B$	=	effective binder volume (%)
	$D_C$	=	compacted density / bulk density of the specimen (t/m <sup>3</sup> )
	$D_B$	=	density of the binder (t/m <sup>3</sup> )
	$B$	=	binder content of the sample (%)
	$b$	=	proportion by mass of binder absorbed (%)

4.2 Calculate the fixed binder volume in the specimen as follows:

$$V_f = \frac{P_{fill} V D_c}{\rho_{fill} (100 - V) 100} (100 - B)$$

where	$V_f$	=	fixed binder volume (% by volume of mix)
	$\rho_{fill}$	=	proportion of the combined filler (% by mass of aggregate and filler)
	$V$	=	voids in dry compacted filler (%)
	$D_c$	=	compacted density (t/m <sup>3</sup> )
	$\rho_{fill}$	=	apparent particle density of the combined filler (t/m <sup>3</sup> )
	$B$	=	binder content (% by mass of mix)

4.3 Calculate the fixed binder fraction in the specimen as follows:

$$f_B = \frac{V_f}{V_B}$$

where  $f_B$  = fixed binder fraction  
 $V_f$  = fixed binder volume (% by volume of mix)  
 $V_B$  = effective binder volume (% by volume of mix)

4.4 Calculate the free binder volume in the specimen as follows:

$$V_F = V_B - V_f$$

where  $V_F$  = free binder volume (% by volume of mix)  
 $V_B$  = effective binder volume (% by volume of mix)  
 $V_f$  = fixed binder volume (% by volume of mix)

4.5 Calculate the free binder fraction in the specimen as follows:

$$F_B = \frac{V_F}{V_B}$$

where  $F_B$  = free binder fraction  
 $V_F$  = free binder volume (% by volume of mix)  
 $V_B$  = effective binder volume (% by volume of mix)

## 5 Reporting

The following shall be reported:

- 5.1 Effective binder volume to the nearest 0.1%
- 5.2 Free binder volume to the nearest 0.1%
- 5.3 Fixed binder fraction to the nearest 0.01, and
- 5.4 The number of this Test Method, that is Q321.

The following may be reported:

- 5.5 Fixed binder volume to the nearest 0.1%, and
- 5.6 Free binder fraction to the nearest 0.01.

## 6 Notes on method

- 6.1 Where the binder absorption of the aggregate in the sample is to be obtained using Test Method Q211 but is known from previous determination, further testing in accordance with Q211 is unnecessary.

- 6.2 Where the binder absorption of the aggregate in the sample is to be obtained using an established binder absorption/water absorption relationship, the following calculation may be used:

$$b_a = 0.55WA$$

where  $b_a$  = binder absorption of the aggregate (% by mass of aggregate)  
 $WA$  = water absorption of the aggregate (%)

$WA$  may be calculated using either of the following which assume the filler component to have an absorption value equivalent to the mean of the coarse and fine aggregate absorption values.

- a) Where water absorption values are available for the coarse and fine fractions of the combined aggregate, calculate the water absorption of the aggregate as follows:

$$WA = \frac{P_c WA_c + P_f WA_f}{P_c + P_f}$$

where  $WA$  = water absorption of the aggregate (%)  
 $P_c$  = proportion of coarse aggregate (%)  
 $WA_c$  = water absorption of coarse aggregate (%)  
 $P_f$  = proportion of fine aggregate (%)  
 $WA_f$  = water absorption of fine aggregate (%)

- b) Where water absorption values are available for the coarse and fine fractions of each individual aggregate component of the combined aggregate, calculate the water absorption as follows:

$$WA = \sum_{i=1}^n P_i WA_i$$

where  $WA$  = water absorption of the aggregate (%)  
 $P_i$  = proportion of the  $i^{\text{th}}$  aggregate component in the combined aggregate (%)  
 $WA_i$  = water absorption of  $i^{\text{th}}$  aggregate component calculated using Test Method AS 1141.6.1 (%)  
 $n$  = number of aggregate components

- 6.3 Where binder absorption of the aggregate is determined using Test Method Q211 or an established binder absorption/water absorption relationship, it is expressed as a percentage by mass of aggregate. To convert from percentage by mass of aggregate to percentage by mass of mix, the following calculation may be used:

$$b_m = b_a - \frac{Bb_a}{100}$$

where  $b_m$  = binder absorption of the aggregate (% by mass of mix)

$b_a$  = binder absorption of the aggregate (% by mass of aggregate)

$B$  = binder content of the sample (%)

- 6.4 Where the density of the binder is unknown and circumstances do not allow its determination, a value of 1.040 t/m<sup>3</sup> may be assumed.

## Test Method Q323: Equivalent compaction temperature for warm mix asphalt

### 1 Source

This Test Method is based on the procedure outlined in German Asphalt Paving Association (DAV) (2009) *Warm mix asphalts: tips and tricks developed by professionals for professionals*. It also refers to Australian Standard Test Methods AS/NZS 2891.2.2: *Sample preparation – Compaction of asphalt test specimens using a gyratory compactor* and AS/NZS 2891.9.2: *Determination of bulk density of compacted asphalt – Presaturation method*, and Transport and Main Roads Test Methods Q305, Q306C and Q309.

### 2 Scope

This Test Method sets out the procedure for determining the equivalent compaction temperature for WMA, by means of comparing and matching the compacted densities of asphalt mix prepared with and without the WMA technology. The method requires prior preparation of asphalt mix using Test Method Q309 without the warm mix additive (reference mix) and the same asphalt mix with the warm mix additive (WMA mix). It allows test specimens to be compacted using either gyratory or Marshall compaction.

This Test Method covers the determination of an equivalent compaction temperature for dense graded and stone mastic asphalt mixes. The asphalt mix design chosen for testing shall not contain RAP.

### 3 Apparatus

3.1 The equipment required for this Test Method is listed in the following references:

- a) Q305 - Stability, flow and stiffness of asphalt - Marshall
- b) Q306C - Compacted density of asphalt - silicone sealed
- c) Q309 - Preparation and testing of asphalt mix
- d) AS/NZS 2891.2.2 - Methods of sampling and testing asphalt - Sample preparation - Compaction of asphalt test specimens using a gyratory compactor, and
- e) AS/NZS 2891.9.2 - Methods of sampling and testing asphalt - Determination of bulk density of compacted asphalt - Presaturation method

### 4 Procedure

The procedure shall be as follows:

#### 4.1 Aggregate Sampling

Sufficient quantities of aggregates required for all testing shall be sampled from the same stockpiles.

#### 4.2 Binder sampling

All binders used must be from the same production batch. Warm mix additives should be blended with the binder immediately prior to testing and any excess blended product discarded after testing. A new batch of blended binder shall be used for each test.

#### 4.3 Compaction method

Select either the gyratory compaction method (AS/NZS 2891.2.2 – 120 cycles) or the Marshall compaction method (Q305 – 50 blows) as appropriate.

#### **4.4 Specimen preparation**

4.4.1 For both the reference and WMA mixes, prepare as per Q309 using riffled and fractionated aggregates to the selected mix design grading.

##### 4.4.2 Reference mix specimens

- a) From the sample of reference mix, compact four specimens in accordance with the relevant method (AS/NZS 2891.2.2 or Q305) at the compaction temperature in accordance with Table 3 of Q305 for the mix and binder type (for example,  $150 \pm 3^\circ\text{C}$  for dense graded asphalt mix containing Class 320 bitumen).
- b) Determine the compacted density of each reference mix specimen in accordance with Subsection 4.5.1 and calculate the mean.
- c) Determine the maximum density of the reference mix in accordance with Test Method AS/NZS 291.7.1
- d) Determine the air voids of each reference mix specimen in accordance with Test Method AS/NZS 2891.8 or Q311 and calculate the mean.
- e) If the reference mix specimens do not have a mean air voids content of  $4.5 \pm 0.5\%$ , adjust the mix grading and/or binder content so that the reference mix test specimens produce a mean air voids content of  $4.5 \pm 0.5\%$ . The adjusted design grading and/or binder content must then be used for all testing.
- f) Repeat the process with another set of four specimens.

##### 4.4.3 WMA specimens

From the sample of WMA mix, compact at least three WMA specimens at each of several compaction temperatures (for example, 110, 120, 130, 140 and  $150 \pm 3^\circ\text{C}$ ) in accordance with the relevant method (AS/NZS 2891.2.2 or Q305).

#### **4.5 Compacted density measurement of specimens**

##### 4.5.1 Reference mix specimens:

- a) Determine the compacted density of the four reference mix specimens to the nearest  $0.001 \text{ t/m}^3$  prepared in Subsection 4.4.2, in accordance with Test Method AS/NZS 2891.9.2 or Q306C. Determine the compacted density to the nearest  $0.001 \text{ t/m}^3$  of each specimen prepared in Subsection 4.2.1, in accordance with Test Method AS 2891.9.2, Q306B or Q306C.
- b) Calculate the compacted density for the four reference mix specimens to the nearest  $0.001 \text{ t/m}^3$  and record this as the mix reference density for that set of four.
- c) Repeat steps 4.5.1 a) and b) for the second set of four specimens.
- d) If the difference in mean compacted density of the two sets of reference mix test specimens is  $\leq 0.3\%$ , determine the mean of the two specimens and record this as the reference compacted density.
- e) If the difference between the two sets of reference mix test specimens is  $> 0.3\%$  of the mix reference density, repeat the procedure.

##### 4.5.2 WMA specimens

- a) Determine the compacted density to the nearest  $0.001 \text{ t/m}^3$  of each specimen prepared in Subsection 4.2.2, in accordance with Test Method AS/NZS 2891.9.2 or Q306C.

- b) For each set of WMA specimens prepared at each compaction temperature, calculate the mean compacted density to the nearest 0.001 t/m<sup>3</sup>.

#### **4.6 Equivalent compaction temperature for WMA**

- 4.6.1 Plot the mean compacted density results of the WMA specimens determined in Subsection 4.5.2(b) against the corresponding compaction temperatures to create a compacted density-temperature curve for WMA, similar to Figure 1.
- 4.6.2 Add the mean compacted density of reference mix specimens data point determined in Subsection 4.5.1 (b) to the same graph.
- 4.6.3 As illustrated in Figure 1, determine the temperature corresponding to this reference mix density on the density-temperature curve for WMA. Record this temperature as the calculated equivalent compaction temperature for WMA (Note 6.1).

#### **4.7 Validation of calculated equivalent compaction temperature**

- 4.7.1 Compact at least four WMA specimens at the calculated equivalent compaction temperature in accordance with the relevant method (AS/NZS 2891.2.2 or Q305).
- 4.7.2 Determine the compacted density to the nearest 0.001 t/m<sup>3</sup> of each of the validation specimens in accordance with Test Method AS/NZS 2891.9.2 or Q306C.
- 4.7.3 Calculate the mean compacted density for the validation specimens to the nearest 0.001 t/m<sup>3</sup> and record this as the mix validation density.
- 4.7.4 If the difference between the mix validation density and the mix reference density is ≤ 0.3% of the mix reference density, accept the calculated equivalent compaction temperature as being validated.
- 4.7.5 If the difference between the mix validation density and the mix reference density is > 0.3% of the mix reference density, repeat the procedure.

### **5 Reporting**

The following shall be reported:

- 5.1 Reference mix and specimens:
  - a) mean bulk density of the reference specimens to the nearest 0.001 t/m<sup>3</sup>
  - b) maximum density of the reference mix to the nearest 0.001 t/m<sup>3</sup>
  - c) mean air voids of the reference specimens to the nearest 0.1%
  - d) mean binder content to the reference specimens to the nearest 0.05%
  - e) particle size distribution of the reference sample - the cumulative per cent passing all sieves to the nearest 1% for values ≥ 10%, and to the nearest 0.1% for values < 10%.
- 5.2 WMA mix and specimens:
  - a) the mean bulk density of the WMA specimens to the nearest 0.001 t/m<sup>3</sup> compacted at each of the five test temperatures, along with the compaction temperature.
- 5.3 Validation specimens and equivalent compaction temperature
  - a) the mean bulk density of the validation specimens to the nearest 0.001 t/m<sup>3</sup> compacted at the calculated equivalent compaction temperature
  - b) validated equivalent compaction temperature for the WMA to the nearest 5°C



5.4 Compaction information:

- a) the compaction method used, including the number of Marshall blows or number of gyratory compaction cycles

5.5 The number of this Test Method, that is Q323.

**6 Notes on method**

- 6.1 For additional accuracy when using Microsoft Excel, plot the compacted density in  $\text{kg/m}^3$  and use one of the five trendline options (exponential, linear, logarithmic, polynomial or power) that provides an  $R^2$  value closest to 1.0.

**Figure 1 - Compacted density versus compaction temperature**

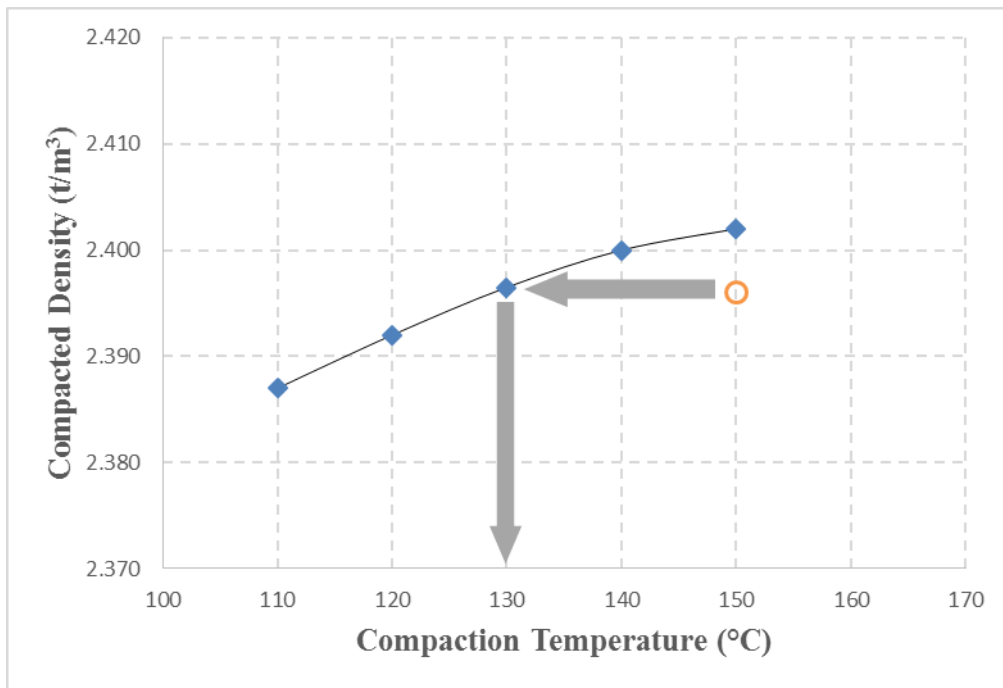

## Test Method Q324: Rapid drying of compacted asphalt specimens - vacuum

### 1 Source

This method is based on ASTM D7227: *Standard practice for rapid drying of compacted asphalt specimens using vacuum drying apparatus.*

### 2 Scope

This method describes a procedure for drying compacted asphalt specimens using a vacuum drying apparatus. It is applicable to a range of laboratory compacted and field specimens including cylindrical, slab and prism specimens.

### 3 Apparatus

The following apparatus is required:

- 3.1 Vacuum apparatus meeting the following requirements:
  - a) chamber of suitable capacity for asphalt specimens. With a vacuum pump capable of evacuating the chamber and maintaining a pressure of 6 Torr or less. With automatic vacuum, airflow and temperature control features to ensure drying of the specimens at close to room temperatures (Note 8.1).
  - b) water removable plate, used for removing free water from the bottom of the vacuum chamber, and
  - c) electronic cold trap with an airflow divider, used for trapping water before it enters the vacuum pump.
- 3.2 Balance, a top pan balance of suitable capacity, with a resolution of at least 0.1 g and with a limit of performance within the range of  $\pm 0.5$  g.
- 3.3 Thermometer, an infra-red having a temperature range which includes the range of 15-30°C and graduated to 1°C or less with an uncertainty of no more than 0.5°C.

### 4 Definitions

For this method, the following definition shall apply:

- 4.1 Constant mass – when vacuum drying, specimen is considered to have reached a constant mass when the difference between successive weighings, after a further 15 minutes vacuum drying, is not more than 0.03 percent.

### 5 Materials

The following materials are required:

- 5.1 Absorptive cloth for drying the surface of the specimens.

### 6 Procedure

The procedure shall be as follows:

#### 6.1 Checking vacuum apparatus

- 6.1.1 Follow the manufacturer's recommendations for warm-up and self-test procedures.
- 6.1.2 Using an absorptive cloth dry the cold trap and specimen chamber.

- 6.1.3 Operate the unit without any specimens and check the pressure reading on the display is 6 Torr or less. If the indicated pressure is higher than 6 Torr, check the system for oil level and quality, seals or water in the chamber.

## **6.2 Drying specimens**

- 6.2.1 Using the infra-red thermometer check the specimen temperature is in the range of 15 - 30°C. If not place the specimens in a room temperature environment until the surface temperature lies within the range of 15 - 30°C.
- 6.2.2 Using an absorptive cloth remove any excess water from the surface of the specimen.
- 6.2.3 Determine the wet mass of the specimen ( $m_1$ ).
- 6.2.4 Place the specimen on top of a specimen support plate, or on a mesh shelf within the chamber.
- 6.2.5 Close the vacuum chamber and using the controls start the drying process.
- 6.2.6 Remove the specimen from the vacuum chamber and determine the dry mass of the specimen ( $m_2$ ).
- 6.2.7 Return the specimen to the vacuum chamber and dry for at least another 15 minutes.
- 6.2.8 Repeat Steps 6.2.5 to 6.2.7 until such time that the specimen has reached constant mass (Note 8.2).
- 6.2.9 At the completion of the drying process, remove the cold trap lid and the airflow divider plate and wipe out any free-standing water in the cold trap.

## **7 Reporting**

The following shall be reported:

- 7.1 The number of this Test Method, that is Q324.

## **8 Notes on method**

- 8.1 Since the specimen cools during the evaporation process, making water harder to evaporate at low temperature, it is important to have suitable temperature controls in the chamber to ensure the specimen remains at close to room temperature. Automatic controls within the unit allow the specimen to remain at close to room temperature by periodically allowing a flow of warm air to enter the vacuum chamber. Cycling between vacuum and airflow conditions allows the specimen to dry in a short period of time. Completely saturated specimens can be dried in about 30 minutes. The typical cycling times are 30 to 180 seconds of vacuum operation followed by 30 to 120 seconds of airflow.
- 8.2 Some vacuum apparatus are factory calibrated to sense a "dry specimen condition". For these apparatus Steps 5.2.7 and 5.2.8 may be omitted provided the manufacturers procedure for determining and checking the dry specimen condition is followed.

## Test Method Q325: Stability of asphalt – Hamburg wheel tracker (HWT)

### 1 Source

This Test Method applies the principles of AASHTO T324 – *Hamburg Wheel-Track Testing of Compacted Hot Mix Asphalt (HMA)*. The Test Method has been further modified to align with the requirements of Texas Department of Transport method Tex-242-F *Hamburg wheel tracking test* as follows:

- apply a tolerance to the diameter of the steel wheel
- specify test specimen thickness of  $62 \pm 2$  mm
- specify water circulation depth of at least 20 mm on all sides of the test specimen, and
- manufacture laboratory specimens to target air voids of 7.0%, cool for 24 hours and test within 3 days of compaction.

### 2 Scope

This Test Method describes the procedure for determining the stability of asphalt mixes under loading while submerged in water. It involves monitoring the deformation (rutting) that occurs in an asphalt specimen undergoing wheel tracking motion with loaded steel wheels. The Test Method is applicable to asphalt mix either manufactured in the laboratory or sampled from an existing asphalt pavement, and can be performed using asphalt slabs, cores or laboratory manufactured specimens.

The test is used to determine the susceptibility to failure by means of moisture damage, poor binder properties or structural weakness of the asphalt in the presence of high temperatures and/or water.

### 3 Apparatus

Where appropriate, the working tolerances of apparatus are contained in Table 1. The following apparatus is required:

#### 3.1 Hamburg Wheel Tracker comprising the following:

##### 3.1.1 Wheel tracking device:

- a) loaded wheel mechanism, consisting of a single or dual steel wheel of diameter 203 mm and width 47 mm
- b) means of loading the wheel so that an applied force of 705 N is central and normal to the top surface of the test specimen
- c) the wheel making 52 passes (26 cycles) across the specimen per minute, travelling across at least the central 230 mm of the specimen and varying sinusoidally over time, and
- d) test base that should accommodate the fitting of mounting systems up to 400 mm in length and 300 mm in width. There should be (at least) the capabilities to cater for specimens  $62 \pm 2$  mm in thickness.

3.1.2 Rut depth measurement system:

- a) rut depth measurement device, an electronic displacement measuring device, preferably a LVDT having a minimum travel of 20 mm and a limit of performance within the range of  $\pm 0.15$  mm
- b) a means for continuously recording rut depth measurements at progressive numbers of wheel tracker cycles – at least every 100 cycles with more regular readings in the first 100 cycles (for example, at 1, 2, 3, 4, 5, 6, 7, 8, 9, 10, 20, 30, 40, 50, 60, 70, 80, 90, 100, 200, 300 and so on cycles)
- c) the system must be capable of measuring the rut depth without stopping the wheel and reference this measurement to the number of wheel passes, and
- d) The system must have a fully automated data acquisition and test control system.

3.1.3 Temperature control system:

- a) a water bath controlled to within  $\pm 1^\circ\text{C}$  of the test temperature, and
- b) fitted with an overflow device and of sufficient capacity to contain a test specimen with the water circulating a minimum of 20 mm on all sides.

3.1.4 Specimen mounting system that allows rigid fixing of either moulds containing asphalt slabs, laboratory prepared specimens or cores to the wheel tracker.

3.2 Core test moulds (Figure 1) consist of the following, metal moulds with internal dimensions of 360 mm by 300 mm. In addition to the metal mould are moulds that consist of a high-density polymer, plastic or gypsum plaster material that snugly fits into the metal mould does not allow for shifting of the specimen during testing. The mould should be able to accommodate two core or laboratory compacted specimens of 150 mm diameter and thickness of  $62 \pm 2$  mm, with the edge of each specimen cut such that the moulds are flush against each other.

3.3 Lifting device, to move a mould to and from the Hamburg Wheel Tracker.

3.4 Saw, diamond tipped masonry saw for cutting specimens to size (if required).

3.5 Rule for measuring specimens.

3.6 Suitable markers/marketing medium to mark specimens.

3.7 Digital camera.

3.8 Straight edge for striking off plaster.

## 4 Materials

The following materials are required:

4.1 Regulation course material, a mixture of gypsum plaster (plaster of Paris) and water at approximately a 1:1 ratio (Note 9.2).

4.2 Potable water.

## 5 Preparation

The test specimens shall be prepared as follows:

5.1 Each test with a dual-wheel Hamburg device requires two slab specimens or four core/ pat specimens (arranged in two sets of two cores in core mould). Specimens can either be manufactured in the laboratory or sampled from a pavement.

5.2 For each specimen:

5.2.1 Determine the bulk density of the specimens in accordance with Test Method AS/NZS 2891.9.2.

5.2.2 For laboratory manufactured specimens determine the maximum density of the asphalt mix in accordance with Test Method AS/NZS 2891.7.1 (Note 9.2)

5.2.3 Determine the air void content of the specimens in accordance with Test Method AS/NZS 2891.8.

### 5.3 Laboratory manufactured slab specimens

5.3.1 Prepare slab specimens manufactured in the laboratory in accordance with Test Method AG:PT/T220. Laboratory manufactured test specimens will have a thickness of  $62 \pm 2$  mm and target air voids of  $7.0 \pm 1\%$ . Allow compacted specimens to cool at room temperature on a clean, flat surface for 24 hours and test within 3 days of moulding.

5.3.2 Secure the asphalt slab in the Hamburg test mould.

### 5.4 Laboratory manufactured pat specimens

5.4.1 Prepare laboratory manufactured pat specimens using the gyratory compactor in accordance with Austroads Test Method AG:PT/T212 to a thickness of  $62 \pm 2$  mm and target air voids of  $7.0 \pm 1\%$ . Allow compacted specimens to cool at room temperature on a clean, flat surface for 24 hours and test within 3 days of moulding.

5.4.2 Cut the pat specimens, with the saw, along a secant or chord line (see Figure 3) so that when joined together in the moulds there is minimal gap between the cut faces of each specimen and the length of the cut faces is greater than the width of the wheel. The preferred method of cutting the specimens is to clamp the two specimens together and make one cut evenly through the point where the specimens touch. Re-clamp the specimens together so that the cut faces are touching and make another cut along the joint. Repeat this process until such time that the length of the cut face is at least 50 mm.

5.4.3 If required, invert the specimens and place them face down in the high-density polyethylene moulds.

5.4.4 Prepare the regulation course material and pour it over the inverted cores to fill the moulds. Strike off any excess material using the straight edge so that the regulation course material provides a smooth and even surface level with the edges of the moulds. Allow to cure for 24 hours.

5.4.5 Secure the high-density polyethylene mould and specimens in the Hamburg mould prior to testing.

### 5.5 Field sampled slab specimens

5.5.1 Slab specimens sampled from the pavement will have minimum dimensions of 300 mm length, 300 mm width and a minimum thickness of 40 mm for 14 mm nominal maximum aggregate size or 50 mm for 20 mm nominal aggregate size and a maximum thickness of 90 mm. The specimens will consist of a single layer of material and have no discontinuities. Examine slab specimens for any defects caused through sampling and reject if cracks are visible to the naked eye or if the geometry of the specimen is compromised through spalling of corners and edges. Indicate the rolling or traffic direction clearly indicated on the upper surface.

- 5.5.2 For slab specimens having dimensions greater than 400 mm length and 300 mm width, cut a test specimen measuring about 400 by 300 mm from the central portion of the slab specimen using the masonry saw, and discard the remainder.
- 5.5.3 Remove the base of the compaction mould.
- 5.5.4 Invert the test specimen and place it centrally within the raised test mould.
- 5.5.5 Prepare the regulation course material and pour it over the inverted test specimen to fill the test mould. Strike off any excess material using the straight edge so that the regulation course material provides a smooth and even surface level with the upper edges of the test mould.
- 5.5.6 Allow the regulation course material to cure for 24 hours before testing.
- 5.5.7 If the dimensions of the asphalt specimen and mould differ by more than 0.5 mm fill the gap with regulation course material.
- 5.5.8 Remove any regulation course material from the top surface of the test specimen.
- 5.5.9 Carefully remove the test specimen from the compaction mould and secure it in the test mould.

## 5.6 Field sampled core specimens

- 5.6.1 Core specimens will have a minimum diameter of 140 mm and a minimum depth of 40 mm for 14 mm nominal maximum aggregate size and 50 mm for 20 mm nominal aggregate size.
- 5.6.2 If required, cut the core specimen to give a height equal to the height of the high-density polyethylene moulds. Otherwise prepare the core specimen in accordance with Test Method Q303A or AS 2891.1.2 Clause 8.
- 5.6.3 Cut the core specimens, with the saw, along a secant or chord line (see Figure 3) so that when joined together in the moulds there is minimal gap between the cut faces of each specimen and the length of the cut faces is greater than the width of the wheel. The preferred method of cutting the specimens is to clamp the two specimens together and make one cut evenly through the point where the specimens touch. Re-clamp the specimens together so that the cut faces are touching and make another cut along the joint. Repeat this process until such time that the length of the cut face is at least 50 mm.
- 5.6.4 If the core heights are less than the thickness of the mould, invert the specimens and place them face down in the mould.
- 5.6.5 Prepare the regulation course material and pour it over the inverted cores to fill the mould. Strike off any excess material using the straight edge so that the regulation course material provides a smooth and even surface level with the edges of the mould. Allow to cure for 24 hours before testing.
- 5.6.6 Secure the high-density polyethylene mould and specimens in the Hamburg mould prior to testing.
- 5.7 Identify each specimen with a marker and if required photograph each specimen before and after testing.

## 6 Procedure

The procedure shall be performed on each of the test specimens as follows:

- 6.1 Fit the mould and specimen into the wheel tracking device and fill with water until the depth of water over the specimens is 20 mm.

- 6.2 Turn on the wheel tracking device and enter the project information.
- 6.3 Set the test temperature, maximum rut depth and termination passes (typically 20,000 passes or 20 mm rut depth). Refer to the relevant specification for asphalt mix compliance requirements.
- 6.4 Allow the water temperature to increase up to the test temperature of  $50 \pm 1^\circ\text{C}$  and condition the test specimen at that temperature for a minimum of 30 minutes but no more than 1 hour prior to starting the test.
- 6.5 At the commencement of testing but prior to the cycles starting, ensure the LVDT is zeroed.
- 6.6 Begin the automated testing program and monitor the rut depth progression over the first 50 – 100 cycles.
- 6.7 Allow the wheel tracker to run until the predetermined number of cycles or maximum rut depth have been achieved.
- 6.8 Remove the specimen and base frame from the device and remove the specimen from the frame by loosening the bolts.
- 6.9 Clear the water bath of any loose material and drain if required.
- 6.10 Take photos of each whole specimen after testing. Cut the specimen into quarters and take photographs of all internal faces of the specimen.

## 7 Calculations

Calculations shall be as follows:

- 7.1 Plot the rut depth vs cycles for each test and identify the creep and stripping sections (if any) of the curve (Figure 2).
- 7.2 Calculate the following:
  - 7.2.1 Calculate the slope ( $m_c$ ) and intercept ( $C_c$ ) of the creep section of the curve.
  - 7.2.2 Calculate the slope ( $m_s$ ) and intercept of the stripping ( $C_s$ ) section of the curve.
  - 7.2.3 Calculate the stripping inflection point as follows:

$$SIP = \frac{C_s - C_c}{m_c - m_s}$$

- where
- |       |   |  |
|-------|---|--|
| $SIP$ | = | stripping inflection point (cycles)            |
| $C_s$ | = | intercept of stripping section of curve (mm)   |
| $C_c$ | = | intercept of creep section of curve (mm)       |
| $m_c$ | = | slope of creep section of curve (mm/cycle)     |
| $m_s$ | = | slope of stripping section of curve (mm/cycle) |

## 8 Reporting

The following shall be reported:

- 8.1 Specimen source and form (laboratory or field; slab, pat or core).
- 8.2 Age of the specimen.
- 8.3 Number of cycles completed.
- 8.4 Rut depth (mm) at termination cycles.



- 8.5 Test temperature.
- 8.6 Air voids of specimen (%).
- 8.7 Number of cycles at stripping inflection point.
- 8.8 The number of this Test Method, that is Q325.

**9 Notes on method**

- 9.1 The Controls Slab Compactor satisfies the requirements of the segmental wheel compactor.
- 9.2 Before handling the plaster, the operator should consult the relevant SDS.

**Table 1 – Test apparatus requirements**

Apparatus	Requirements	Tolerance
<b>Steel wheel</b>		
Diameter (mm)	203	± 2.0
Wheel load (N)	705	± 4.5
Wheel passes (passes/minute)	52	± 2
Wheel cycles (cycles/minute)	26	± 1
<b>Water bath</b>		
Temperature (°)	Test temperature	± 1

**Figure 1 – Core test mould**

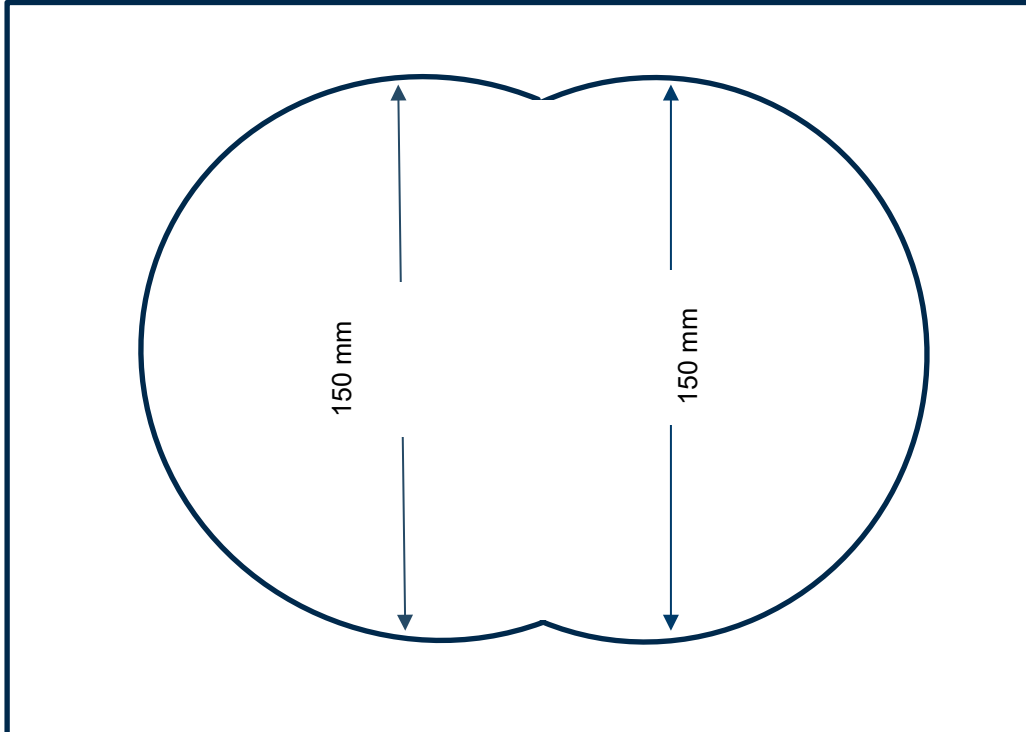

Figure 2 – Example of rut depth v cycles plot

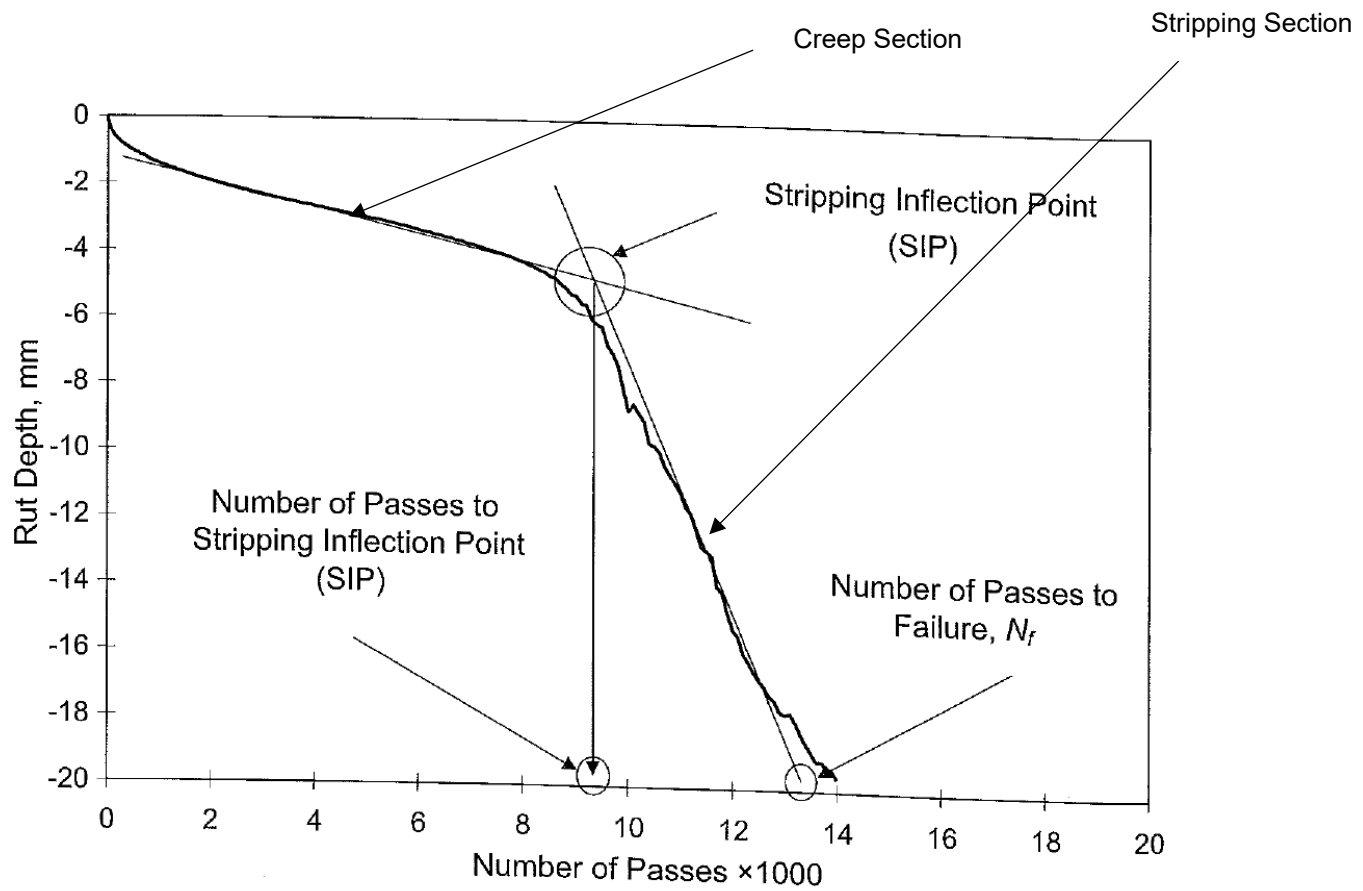
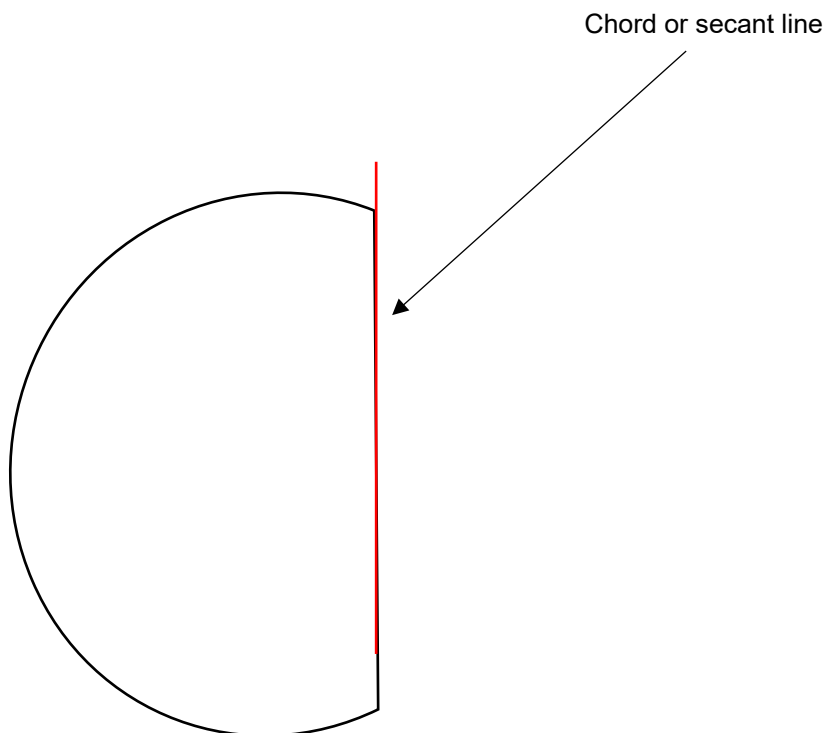

Figure 3 – Diagram showing the chord or secant line



## Test Method Q327: Richness modulus of asphalt

### 1 Source

This Test Method is based on European Standard EN 13108-1: *Bituminous Mixtures - Material Specifications – Part 1: Asphalt Concrete* (Note 6.1).

### 2 Scope

This Test Method sets out a procedure for calculation of the Richness modulus (Duriez 1950) which is related to the thickness of the bitumen layer around the aggregates in the asphalt. It requires prior determination of the binder content, aggregate density and the percentage of aggregates at different test sieves sizes.

### 3 Procedure

The procedure shall be as follows:

- 3.1 Determine the binder content ( $B$ ) and aggregate particle size distribution of the asphalt sample in accordance with Test Method AS/NZS 2891.3.1, Q308A or AG:PT/T234 as appropriate (Note 6.1).
- 3.2 Determine the particle density of the combined mineral aggregate ( $\rho_a$ ) in accordance with Test Method Q317 or Test Method AS/NZS 2891.8.

### 4 Calculations

Calculations shall be as follows:

- 4.1 Calculate the Richness modulus as follows:

$$K = \frac{\left(\frac{100B}{100-B}\right)}{\left(\frac{2.65}{\rho_a}\right)^5 \sqrt{\frac{0.25G + 2.3S + 12s + 150f}{100}}}$$

- where
- $K$  = Richness modulus
  - $B$  = binder content of sample (%)
  - $\rho_a$  = particle density of combined aggregate ( $t/m^3$ )
  - $G$  = proportion of aggregate particles greater than 6.30 mm (%)
  - $S$  = proportion of aggregate particles between 6.30 mm and 0.250 mm (%)
  - $s$  = proportion of aggregate particles between 0.250 mm and 0.075 mm (%)
  - $f$  = proportion of aggregate particles less than 0.075 mm (%)

### 5 Reporting

The following shall be reported:

- 5.1 Richness modulus to the nearest 0.05.
- 5.2 The number of this Test Method, that is Q327.

## **6 Notes on method**

- 6.1 To directly measure aggregate proportions required in Section 4, 6.30 mm and 0.250 mm test sieves may be included when determining the particle size distribution. Alternatively, the aggregate proportions may be interpolated using a linear relationship from the particle size curve.

## **7 References**

- 7.1 Duriez M (1950), *Traité de matériaux de construction*, (Dunod ed), Paris.

## Test Method Q364: Recovery of polymer modified binder from polymer modified emulsion

### 1 Source

This Test Method is based on outcomes from internal laboratory investigations as reported in the Transport and Main Roads Internal Report R2523: *Investigation of Test Methods for Recovering Polymer Modified Binder from Polymer Modified Bituminous Emulsion*.

### 2 Scope

This Test Method describes the recovery of polymer modified binder from polymer modified emulsion. It involves separation of the binder by ethanol precipitation, and removal of the aqueous phase by draining and subsequent evaporation in an oxygen free environment using either a vacuum oven or a nitrogen purged oven. The recovery process is not expected to impact on the properties of the polymer modified binder. The method includes determination of the polymer modified binder content of the emulsion.

### 3 Apparatus

The following apparatus is required:

- 3.1 Mixing container, a 5 L plastic pail having approximate dimensions of diameter 200 mm at the top and 180 mm at the bottom, and height 190 mm.
- 3.2 Mechanical stirrer, fitted with a helix shaped paddle having approximate dimensions of diameter 140 mm and height 140 mm, and capable of stirring the sample at 125 rpm (Figure 1).
- 3.3 Balance of suitable capacity, with a resolution of at least 0.01 g and with a limit of performance within the range of  $\pm 0.05$  g.
- 3.4 Trays, silicon rubber trays having approximate dimensions of 200 mm length, 200 mm width and 50 mm depth.
- 3.5 Spatula, stainless steel spatula having approximate dimensions of length 150 mm and width 15 mm.
- 3.6 Beakers, glass beakers of 500 mL capacity.
- 3.7 Measuring cylinder, a glass measuring cylinder of 250 mL capacity.
- 3.8 Container, metal container fitted with a lid and of sufficient capacity to store the recovered binder.
- 3.9 Gloves, rubber gloves suitable for handling the recovered binder.

The following apparatus may be used in Section 5.2:

- 3.10 Vacuum oven, fitted with a vacuum measuring device and thermostatically controlled over a temperature range including 100°C.
- 3.11 Vacuum system, comprising a vacuum tube connected to a vacuum pump capable of producing an absolute pressure of about 4 kPa with a suitable ice water trap located between the vacuum pump and vacuum oven.
- 3.12 The following apparatus may be used in Section 5.3:

- 3.13 Nitrogen purged oven, thermostatically controlled over a temperature range including 100 to 130°C and, fitted with a nitrogen gas supply and circulation system. The purging outlet of the oven should be fed into a fume extraction system, for example, fume cupboard.

#### 4 Materials

The following materials are required:

- 4.1 Breaking agent, methylated spirits (industrial grade) or ethanol (LR grade).

#### 5 Procedure

The procedure shall be as follows:

- 5.1 Sample preparation

- 5.1.1 Determine the total mass of binder to be recovered for testing.

- 5.1.2 Calculate the mass of emulsion required for binder recovery as follows (Note 8.1):

$$M = \frac{1.5M_B}{0.75}$$

where  $M$  = mass of emulsion required (g)

$M_B$  = moisture content of soil

- 5.1.3 Transfer the emulsion sample to the mixing container (Note 8.2).
- 5.1.4 Position the mechanical stirrer within the mixing container so that the paddle is located centrally with a gap of about 10 mm between the bottom of the paddle and the bottom of the container.
- 5.1.5 Stir the sample in the mixing container using the mechanical stirrer at 125 rpm for at least 10 minutes.
- 5.1.6 At the completion of stirring, immediately pour a quantity of emulsion not less than that calculated in Step 5.1.2 into a tared beaker(s).
- 5.1.7 Record the mass of emulsion in the beaker(s) to the nearest 0.01 g ( $m_e$ ).
- 5.1.8 Transfer a portion of the emulsion from the beaker into a tared silicon rubber tray. This portion should be about 120 g for the vacuum oven method (Subsection 5.2) and about 80 g for the nitrogen purged oven method (Subsection 5.3).
- 5.1.9 Repeat Step 5.1.7 until all of the emulsion in the beaker(s) has been transferred to the trays.
- 5.1.10 Add breaking agent to the residual emulsion in the beaker to separate the binder and aqueous phases.
- 5.1.11 Add a volume of breaking agent to the measuring cylinder approximating the volume of emulsion in each tray.
- 5.1.12 While stirring the emulsion in one of the trays with the spatula, slowly add the breaking agent from the measuring cylinder to separate the binder and aqueous phases.
- 5.1.13 Repeat Step 5.1.11 for each of the remaining trays.
- 5.1.14 Using the spatula, decant the aqueous phase from each of the trays, taking care to ensure none of the binder phase is included.
- 5.1.15 Transfer the binder phase from the beaker and spatula to one of the trays, rinsing with water as required.

- 5.1.16 Remove the binder phase from each tray and hand wash it by kneading and flushing with tap water until foaming ceases.
- 5.1.17 Transfer the binder phase back to each tray and form it into a thin layer to match the size of the tray.
- 5.1.18 Dry the binder phase on each tray using the procedure described in Subsection 5.2 or 5.3 as appropriate.
- 5.2 Vacuum oven method
- 5.2.1 Place each tray in the vacuum oven at 100°C.
- 5.2.2 Gradually increase the vacuum to maximum, taking care to avoid excessive foaming, and allow the sample to be dried at maximum vacuum for two hours.
- 5.2.3 Remove the trays from the vacuum oven and allow them to cool.
- 5.2.4 Invert the samples in the trays then dry them in the vacuum oven at 100°C under maximum vacuum for one hour.
- 5.2.5 Remove the trays from the vacuum oven and allow them to cool to room temperature.
- 5.2.6 Remove the recovered binder from each tray and place it in a tared metal container.
- 5.2.7 Weigh the recovered binder and record the mass to the nearest 0.01 g ( $m_b$ ).
- 5.3 Nitrogen purged oven method
- 5.3.1 Place each tray in the oven set at a temperature of 120°C under nitrogen purging for two hours (Note 8.3).
- 5.3.2 Remove the trays from the oven and allow them to cool.
- 5.3.3 Invert the samples in the trays then dry them in the oven at 120°C under nitrogen purging for one hour.
- 5.3.4 Remove the trays from the oven and allow them to cool to room temperature.
- 5.3.5 Remove the recovered binder from each tray and place it in a tared metal container.
- 5.3.6 Weigh the recovered binder and record the mass to the nearest 0.01 g ( $m_b$ ).

## 6 Calculation

Calculations shall be as follows:

- 6.1 Calculate the polymer modified binder content of the emulsion as follows:

$$PMB = \frac{m_b}{m_e} 100$$

where  $PMB$  = polymer modified binder content (%)  
 $m_e$  = mass of emulsion (g)  
 $m_b$  = mass of recovered binder (g)

## 7 Reporting

The following shall be reported:

- 7.1 Polymer modified binder content of the emulsion to the nearest 0.1%, and
- 7.2 The number of this Test Method, that is Q364.

## 8 Notes on method

- 8.1 This calculation assumes a polymer modified binder content of 75% for the emulsion. A factor of 1.5 is applied to account for variation between the assumed and actual binder contents, as well as for potential binder losses during the recovery process and in the preparation of binder samples for testing.
- 8.2 To achieve efficient mixing without spillage under the stirring conditions of Step 5.1.5, sample sizes of 3 to 4 L can be accommodated in the mixing container. For larger sample sizes, representative sub-sampling or mixing with the mechanical stirrer directly in the sample container should be used. For smaller sample sizes, a longer mixing period in conjunction with manual stirring may be required.
- 8.3 At a temperature of 120°C, the sample should flow to uniformly cover the tray. If this does not occur, the oven temperature may be increased to as high as 130°C provided that it is returned to 120°C as soon as sufficient flow is achieved.

**Figure 1 – Mechanical stirrer paddle**





## Test Method Q372: Cutter content of bituminous materials - modified Dean and Stark

### 1 Source

This Test Method was developed in-house using techniques evolved through internal investigations, based on information and conditions implemented around the apparatus used.

### 2 Scope

This Test Method sets out the procedure for the determination of the cutter content of bituminous materials using a modification to the Dean and Stark method of water extraction.

Internal investigations have indicated that the recovery of cutter from bituminous materials is not affected by cutter concentration. However, the extractive efficiency of this Test Method is reduced for cutter products from the heavier fraction of the distillation range. The recovery efficiencies of this Test Method for different cutter products are detailed in Table 1.

### 3 Apparatus

The following apparatus is required:

#### 3.1 Balances:

- a) Balance of suitable capacity, with a resolution of 0.1 g and with a limit of performance within the range of  $\pm 0.5$  g.
- b) Balance of suitable capacity, with a resolution of 0.01 g and with a limit of performance within the range of  $\pm 0.05$  g.

3.2 Round bottomed flask, of suitable capacity fitted with a ground glass neck (Table 2).

3.3 Boiling chips.

3.4 Heating mantle, thermostatically controlled.

3.5 Dean and Stark heavy entrainer of suitable size (Table 2).

3.6 Reflux condenser, Liebig type, with an effective cooling length of 400 mm.

3.7 Ground glass joint adaptors.

3.8 Wire, of approximately 500 mm in length and approximately 2 mm in diameter.

### 4 Materials

The following material is required:

4.1 Cutter, a sample of the cutter product used in the bituminous emulsion or asphalt material under test (if available) (Note 9.1).

4.2 Binder, a sample of the binder used in the cutback bitumen or asphalt material under test (if available).

4.3 Distilled water or equivalent (for example, reverse osmosis water).

### 5 Sample preparation

The sample shall be prepared as follows:

5.1 Cutback bitumen

- 5.1.1 Thoroughly mix the sample of cutback bitumen.
- 5.1.2 Using a portion of the sample, determine its density ( $D_c$ ) in accordance with either Test Method Q374 or AS 2341.7 (Note 9.2).
- 5.2 Asphalt
  - 5.2.1 Obtain a representative sample of suitable size (Table 2) by coning and quartering in accordance with sub-section 8.2 of Test Method AS/NZS 2891.1.1.
  - 5.2.2 Determine the density of the cutter product used in the material at 25°C in accordance with Test Method Q374, using 0.997 kg/L as the density of water at 25°C (Note 9.3).
- 5.3 Bituminous emulsion
  - 5.3.1 Thoroughly mix the sample of bituminous emulsion.
  - 5.3.2 Determine the density of the cutter product used in the material at 25°C in accordance with Test Method Q374, using 0.997 kg/L as the density of water at 25°C (Note 9.3).

## 6 Procedure

The procedure shall be as follows:

- 6.1 Weigh a sample of suitable size (Table 2) into a tared flask (Note 9.4). Record the mass of the sample ( $m$ ) to the nearest 0.1 g for asphalt samples and to the nearest 0.01 g for all other sample types.
- 6.2 Add distilled water (or equivalent) to the flask in accordance with the guidelines in Table 2.
- 6.3 Add boiling chips to the flask.
- 6.4 Transfer the flask and contents to the heating mantle and use the appropriate adaptors to connect the Dean and Stark apparatus to the flask and the Liebig reflux condenser to the Dean and Stark apparatus. Ensure that all joints and connections are airtight.
- 6.5 Adjust the water flow through the condenser tube to a slow uniform rate.
- 6.6 Heat the flask to raise the temperature to the boiling point of the mixture.
- 6.7 Adjust the heating so that the distillate collects in the entrainer at a rate of 2 to 5 drops per second.
- 6.8 Continue distillation until the volume of cutter collected in the entrainer remains constant for 60 minutes (Note 9.5). Dislodge any cutter adhering to the condenser or entrainer walls using the length of wire.
- 6.9 Allow the contents of the entrainer to cool to room temperature and record the volume of cutter collected to the nearest scale division ( $V$ ) (Note 9.6).

## 7 Calculations

Calculate the cutter content of the sample of cutback bitumen, asphalt or bituminous emulsion using the appropriate calculation, as follows:

### 7.1 Cutback bitumen

#### 7.1.1 No blank determination

Where no blank determination has been made on the original uncut bitumen, calculate the cutter content as follows:

a) Calculate the volume of cutter per mL of cutback bitumen as follows:

$$V_C = \frac{D_C V}{m}$$

where  $V_C$  = volume of cutter per mL of cutback bitumen (mL)  
 $D_C$  = density of cutback bitumen (kg/L)  
 $V$  = volume of cutter recovered from cutback bitumen sample (mL)  
 $m$  = mass of cutback bitumen sample (g)

b) Calculate the cutter content as follows:

$$C_V = \frac{V_C}{1 - V_C} 100$$

where  $C_V$  = cutter content of the cutback bitumen expressed as the volume of cutter per 100 volumes of binder  
 $V_C$  = volume of cutter per mL of cutback bitumen (mL)

#### 7.1.2 With blank determination

Where a blank determination has been made (Note 9.6), calculate the cutter content as follows:

a) Calculate the volume of cutter per mL of cutback bitumen as described in Step 7.1.1 a).

b) Calculate the volume of cutter per mL of the binder blank sample as follows:

$$V_B = \frac{D_B V_O}{m_B}$$

where  $V_B$  = volume of cutter per mL of binder blank sample (mL)  
 $D_B$  = density of binder (kg/L)  
 $V_O$  = volume of cutter recovered from blank sample (mL)  
 $m_B$  = mass of binder sample (g)

c) Calculate the cutter content as follows:

$$C_V = \frac{V_C - V_B}{1 - V_C + V_B} 100$$

where  $C_V$  = cutter content of the cutback bitumen expressed as the volume of cutter per 100 volumes of binder

$V_C$  = volume of cutter per mL of cutback bitumen (mL)

$V_B$  = volume of cutter per mL of binder blank sample (mL)

## 7.2 Asphalt and bituminous emulsion

### 7.2.1 Cutter content by mass

Calculate the cutter content as follows:

$$C_m = \frac{VD}{m} 100$$

where  $C_m$  = cutter content of sample expressed as the percentage by mass of sample (%)

$V$  = volume of cutter recovered from sample (mL)

$D$  = density of cutter (kg/L)

$m$  = mass of sample (g)

### 7.2.2 Cutter content by volume

For asphalt, the cutter content may also be calculated as volume of cutter per 100 volumes of the binder in the asphalt as follows:

a) Calculate the volume of the binder in the asphalt sample as follows:

$$V_a = \frac{mB_a}{D_B(100 - C_m)}$$

where  $V_a$  = volume of binder in asphalt sample (mL)

$m$  = mass of asphalt sample (g)

$B_a$  = binder content of the asphalt (%) (Note 9.7)

$D_B$  = density of binder (kg/L) (Note 9.8)

$C_m$  = cutter content of sample expressed as the percentage by mass of sample (%), as derived in Step 7.2.1

b) Calculate the cutter content as follows:

$$C_V = \frac{V}{V_a} 100$$

where  $C_V$  = cutter content of the asphalt expressed as the volume of cutter per 100 volumes of the binder in the asphalt

$V$  = volume of cutter recovered from sample (mL)

$V_a$  = volume of binder in asphalt sample (mL)

## 8 Reporting

The following shall be reported:

- 8.1 For cutback bitumen and for asphalt (where required), report the cutter content as volumes of cutter per 100 volumes of binder to the nearest 0.1.
- 8.2 For asphalt and bituminous emulsion, report the cutter content as a percentage by mass to the nearest 0.1%.
- 8.3 The number of this Test Method, that is Q372.

## 9 Notes on method

- 9.1 Before handling any cutter oil product, the operator must consult the relevant SDS.
- 9.2 The choice of method for determining the density of the cutback bitumen depends upon the nature of the material. Highly cutback bitumen is better tested by Q374, since its density is likely to be lower than that of water, making AS 2341.7 difficult to perform.
- 9.3 If a sample of the cutter product used is not available, it may be necessary to repeat Steps 6.1 to 6.8 several times to extract sufficient of the cutter to determine its density. Alternatively, a value for cutter density may be assumed, provided that the degree of uncertainty that this introduces to the cutter content is acceptable. For kerosene cutters, a value of 0.78 kg/L may usually be used in the absence of any other data, alternatively the operator could consult the Material Safety Data Sheet for the relevant cutter to obtain a value for density.
- 9.4 The operator should exercise care when transferring the sample to the flask to ensure that no sample comes into contact with the ground glass neck of the flask.
- 9.5 In the case of high cutter content cutback bitumens, if the volume of cutter exceeds the capacity of the entrainer, the sample should be cooled and a quantity of cutter removed by pipette before reheating to complete the analysis. Add the quantity removed to the final result.
- 9.6 Some bitumens contain volatile materials which will increase the volume of cutter extracted during this test. For the accurate determination of cutter content in a cutback made from such bitumens, a blank cutter content determination should be conducted on the bitumen only, if that is available.
- 9.7 Binder content of the asphalt should be determined in accordance with Test Methods AS/NZS 2891.3.1, Q308A or AG:PT/T234 on a representative sample of the same asphalt. No attempt should be made to drive off the cutter before determining the binder content. The additional mass of any cutter originally present in the sample has been accounted for in the calculation in Step 7.2.2 (a).
- 9.8 In the absence of any other evidence, the density of the binder can be assumed to be 1.04 kg/L for bitumen binders and 1.03 kg/L for polymer modified binders.
- 9.9 To be able to reliably ascertain the concentration of a cutter in a cutback bitumen, the identity of the cutter should be known and adjustment factors should be developed for each cutter type to reflect its specific recovery efficiency.
- 9.10 When a mixture of cutters and fluxes of differing volatilities is used in a cutback bitumen, the recovery efficiency can be estimated from a weighted mean of the individual cutter efficiencies.

**Table 1 - Recovery efficiencies for different cutter products (Notes 9.9 and 9.10)**

Cutter material	Recovery (%)
BP Coralite	93 – 95
Shell high flash point cutter	93 – 95
Dieselene	68
Coralite/dieselene blend	84
Furnace oil	8

**Table 2 - Recommended sample sizes, distilled water volumes, flask and entrainer sizes**

Bituminous material	Sample size (g)	Entrainer size (mL)	Distilled water (mL)	Flask size (mL)
Cutback bitumen	50	12.5	500	1,000
Bituminous emulsion	100	12.5	500	1,000
Bitumen	100	3	500	1,000
Asphalt:				
DG7, DG10, DG14	1,000	12.5	*	1,000
DG20, DG28	1,500	12.5	*	2,000

\* Samples to be covered with distilled water (or equivalent) to a depth of 25 mm.

## Test Method Q374: Density of petroleum products

### 1 Source

This Test Method was developed in-house using information contained within technical references.

### 2 Scope

This Test Method describes the procedure for the determination of the density of liquid petroleum products including cutter oils, flux oils and cutback bitumens. The test is performed at 25°C but provision is also made for the reporting of the corresponding density result at 15°C.

### 3 Apparatus

The following apparatus is required:

- 3.1 Balance, of suitable capacity, with a resolution of at least 0.001 g and a limit of performance within the range of  $\pm 0.005$  g.
- 3.2 Volumetric flasks, of 100 mL capacity.
- 3.3 Beakers, of 250 mL capacity.
- 3.4 Filter funnel, a long-stem glass funnel.
- 3.5 Water bath, maintained at a temperature of  $25 \pm 0.1$ °C.
- 3.6 Pasteur pipette.
- 3.7 Glass rod.

### 4 Materials

The following material is required:

- 4.1 Distilled water or equivalent (for example, reverse osmosis water).

### 5 Procedure

The following procedure shall be performed in duplicate (Note 9.1).

- 5.1 Weigh the stoppered flask and record the mass to the nearest 0.001 g ( $m_1$ ).
- 5.2 Fill the flask to about one centimetre below the calibration mark with distilled water (or equivalent) and stopper.
- 5.3 Place the stoppered flask in the water bath so that the water level is above the calibration mark. Leave the flask in the water bath for at least 45 minutes to allow the flask and contents to attain temperature equilibrium.
- 5.4 Using a pasteur pipette, add distilled water (or equivalent) dropwise to the flask until its level almost reaches the calibration mark. Stopper the flask and leave in the water bath for at least 15 minutes.
- 5.5 Using a pasteur pipette, fill the flask to the calibration mark with distilled water (or equivalent). Stopper the flask, remove from the water bath and dry thoroughly.
- 5.6 Weigh the stoppered flask and contents and record the mass to the nearest 0.001 g ( $m_2$ ).
- 5.7 Empty the flask and dry thoroughly.

- 5.8 Stir the sample thoroughly and decant a portion into the beaker.
- 5.9 Using the filter funnel, transfer sufficient of the sample portion from the beaker to the flask to fill it to about one centimetre below the calibration mark (Note 9.2).
- 5.10 Stopper the flask and then place in the water bath so that the water level is above the calibration mark. Leave the flask in the water bath for at least 45 minutes to allow the flask and contents to attain temperature equilibrium.
- 5.11 Using a pasteur pipette or glass rod as appropriate, add sample to the flask until its level almost reaches the calibration mark (Note 9.2). Stopper the flask and leave in the water bath for at least 15 minutes.
- 5.12 Using a pasteur pipette or glass rod as appropriate, fill the flask to the calibration mark with the sample (Note 9.2). Stopper the flask, remove from the water bath and dry thoroughly.
- 5.13 Weigh the stoppered flask and contents and record the mass to the nearest 0.001 g ( $m_3$ ).

## 6 Calculations

Calculations shall be as follows:

- 6.1 Calculate the density of each test portion of the sample as follows:

$$D = \frac{(m_3 - m_1)0.997}{(m_2 - m_1)}$$

- where
- $D$  = density of test portion (kg/L)
  - $m_1$  = mass of stoppered flask (g)
  - $m_2$  = mass of stoppered flask filled with distilled water (or equivalent) (g)
  - $m_3$  = mass of stoppered flask filled with sample (g)

- 6.2 Provided that the difference between the density results from the two test portions is no greater than 0.0016 kg/L, calculate the density of the sample as the mean of the two results.
- 6.3 When the density of the sample at 15°C is required, record to the nearest 0.001 kg/L using Table 1.

## 7 Reporting

The following shall be reported:

- 7.1 Density of the sample at 25°C and/or 15°C as appropriate, to the nearest 0.001 kg/L, and
- 7.2 The number of this Test Method, that is Q374.

## 8 Precision

### 8.1 Repeatability

- 8.1.1 The results of duplicate tests by the same operator are acceptable if they do not differ by more than 0.0012 kg/L.

## 9 Notes on method

- 9.1 Steps 5.1 to 5.7 of the procedure determine the volume of the flask. Checks on this value may only be required periodically.



9.2 It is essential during flask filling that the sample makes no contact with that part of the neck of the flask above the calibration mark. If this is not achieved, it will be necessary to repeat the procedure.

**Table 1 - Comparison of density values of petroleum products at 25°C and 15°C**

Density (kg/L)		Density (kg/L)		Density (kg/L)		Density (kg/L)	
25°C	15°C	25°C	15°C	25°C	15°C	25°C	15°C
0.7500	0.7588	0.8000	0.8072	0.8700	0.8768	0.9550	0.9616
0.7550	0.7638	0.8050	0.8122	0.8750	0.8818	0.9600	0.9666
0.7600	0.7688	0.8060	0.8132	0.8800	0.8868	0.9650	0.9716
0.7620	0.7706	0.8070	0.8141	0.8850	0.8918	0.9700	0.9766
0.7640	0.7728	0.8100	0.8171	0.8900	0.8968	0.9750	0.9816
0.7650	0.7735	0.8150	0.8221	0.8920	0.8988	0.9760	0.9826
0.7680	0.7762	0.8160	0.8230	0.8930	0.8997	0.9770	0.9835
0.7690	0.7772	0.8200	0.8270	0.8950	0.9017	0.9800	0.9865
0.7700	0.7781	0.8250	0.8320	0.9000	0.9067	0.9850	0.9915
0.7710	0.7790	0.8280	0.8350	0.9050	0.9117	0.9900	0.9965
0.7720	0.7800	0.8290	0.8359	0.9100	0.9167	0.9950	1.0015
0.7740	0.7818	0.8300	0.8369	0.9150	0.9217	1.0000	1.0065
0.7750	0.7828	0.8350	0.8419	0.9200	0.9267	1.0050	1.0115
0.7770	0.7846	0.8400	0.8469	0.9250	0.9317	1.0100	1.0165
0.7780	0.7856	0.8450	0.8519	0.9300	0.9367	1.0150	1.0215
0.7800	0.7874	0.8500	0.8569	0.9310	0.9377	1.0200	1.0265
0.7840	0.7914	0.8530	0.8599	0.9320	0.9386	1.0230	1.0295
0.7850	0.7923	0.8540	0.8608	0.9350	0.9416	1.0240	1.0304
0.7900	0.7973	0.8550	0.8618	0.9400	0.9466	1.0300	1.0364
0.7950	0.8023	0.8600	0.8668	0.9450	0.9516	1.0400	1.0464
0.7960	0.8032	0.8650	0.8718	0.9500	0.9566	1.0500	1.0564

Note: Values falling between those listed in Table 1 may be determined by linear interpolation.

## Test Method Q386: Penetration index of bitumen

### 1 Source

This Test Method is based on European Standard EN 13924: *Bitumen and Bituminous Binders – Specification Framework for Special Paving Grade Bitumen – Part 1: Hard Paving Grade Bitumens, Annex A*.

### 2 Scope

This Test Method sets out a procedure for calculation of the penetration index of a sample of bitumen. It requires prior determination of the softening point and penetration of a bitumen sample.

### 3 Procedure

The procedure shall be as follows:

- 3.1 Determine the softening point of the bitumen (*SP*) in accordance with Test Method AS 2341.18.
- 3.2 Determine the penetration of the bitumen (*Pen*) in accordance with either Test Method AS 2341.12 or ASTM D5.

### 4 Calculations

Calculations shall be as follows:

- 4.1 Calculate the penetration index as follows:

$$PI = \frac{(20SP) + (500\log Pen) - 1952}{SP - (50\log Pen) + 120}$$

- where
- PI* = penetration index
  - SP* = softening point (°C)
  - Pen* = penetration (pu) (Note 6.1)

### 5 Reporting

The following shall be reported:

- 5.1 Penetration index to the nearest 0.05.
- 5.2 The number of this Test Method, that is Q386.

### 6 Notes on method

- 6.1 One penetration unit (pu) equals 0.1 mm.

## Test Method Q460A: Compressive stress and recovery of preformed joint filler

### 1 Source

This Test Method is based on ASTM D545-84: *Preformed expansion joint fillers for concrete construction (non-extruding and resilient types)* Section 7.2: *Recovery and compression*, with only minor variations.

### 2 Scope

This Test Method describes the procedure for determining, under specified conditions, both the stress required to compress preformed joint filler to a set strain level, and then the recovery of the filler material once the compressive force has been removed.

### 3 Apparatus

The following apparatus is required:

- 3.1 Compression testing machine, at least Class A as defined in AS 2193, with a moveable lower platen which travels at a uniform vertical rate of 1.3 mm/minute when measured loaded.
- 3.2 Compression platens, having machined parallel bearing surfaces at least 12.5 mm thick and of sufficient area to provide at least 10 mm clearance between the edge of the specimen and any edge of the platen.
- 3.3 Vertical displacement measuring system, to allow the measurement of the vertical displacement at the centre of the specimen. The system can use a dial gauge conforming to the requirements of ISO 463 or JIS B 7503, which has a scale interval of 0.01 mm and a minimum range of 30 mm, or a displacement transducer or any equivalent system of at least equal performance.
- 3.4 Force application assembly, incorporating a spherical seat.
- 3.5 Glass beaker, or similar heat resistant container having a capacity of approximately 5 L (Note 7.1).
- 3.6 Hotplate, with temperature control capable of maintaining a temperature of at least 110°C (Note 7.1).

### 4 Procedure

The procedure shall be as follows:

#### 4.1 Specimen Preparation

- 4.1.1 For self-expanding cork joint fillers only, boil a 120 mm x 120 mm specimen for 1 hour (using the glass beaker and hot plate) and air dry for 24 hours.
- 4.1.2 Cut a test specimen, 100 mm square (tolerance  $\pm 0.5$  mm), from the preformed joint filler such that each edge is freshly cut.

#### 4.2 Testing

- 4.2.1 Locate the lower and upper compression platens centrally on the lower platen of the testing machine. Place the displacement measuring system above the centre of the upper platen and record the dial gauge reading ( $d_1$ ).

- 4.2.2 Raise the upper platen by hand and locate the test specimen centrally between the platens. Record the dial gauge reading ( $d_2$ ).
- 4.2.3 Using the force application assembly, apply and record the maximum force ( $F$ ) necessary to compress the test specimen to 50 per cent of its original thickness (Note 7.2).
- 4.2.4 Immediately remove the force from the test specimen and allow it to recover for 30 minutes with the upper platen, the displacement measuring system and the load application assembly in place.
- 4.2.5 Repeat Steps 4.2.3 and 4.2.4 applying sufficient force to again achieve a compression of 50 per cent of the original thickness.
- 4.2.6 Compress the test specimen a third time by repeating Step 4.2.5.
- 4.2.7 Immediately remove the force, disassemble the testing apparatus and allow the test specimen to recover unrestrained for 24 hours.
- 4.2.8 At the end of the recovery period, locate the lower and upper compression platens on a flat surface such as the lower platen of the testing machine. Place the displacement measuring system above the centre of the upper platen and record the dial gauge reading ( $d_3$ ).
- 4.2.9 Raise the upper platen by hand and locate the recovered test specimen centrally between the platens. Record the dial gauge reading ( $d_4$ ).

## 5 Calculations

Calculations shall be as follows:

- 5.1 Calculate the applied stress ( $S$ ) as follows:

$$S = \frac{F}{A}$$

- where
- $S$  = applied stress (MPa)
  - $F$  = force required to achieve 50% thickness (N)
  - $A$  = area of test specimen (mm<sup>2</sup>) (taken as 10,000 mm<sup>2</sup>)

- 5.2 Calculate the percentage recovery ( $R$ ) as follows:

$$R = \frac{100(d_4 - d_3)}{d_2 - d_1}$$

- where
- $R$  = recovery (%)
  - $d_4$  = dial gauge reading for upper platen with recovered test specimen (mm)
  - $d_3$  = dial gauge reading for upper platen after testing (mm)
  - $d_2$  = dial gauge reading for upper platen with untested test specimen (mm)
  - $d_1$  = dial gauge reading for upper platen before testing (mm)

## 6 Reporting

The following shall be reported:

- 6.1 Applied stress to the nearest 0.1 MPa.
- 6.2 Percentage recovery to the nearest 0.5%.
- 6.3 The number of this Test Method, that is Q460A.

## 7 Notes on method

- 7.1 The glass beaker and hotplate are only required when a self-expanding cork joint filler is to be tested.
- 7.2 The dial gauge reading corresponding to 50 per cent compression is calculated as follows:

$$d_{50} = d_1 + \frac{(d_2 - d_1)}{2}$$

where  $d_{50}$  = dial gauge or transducer reading corresponding to 50% compression (mm)

$d_1$  = dial gauge reading for upper platen before testing (mm)

$d_2$  = dial gauge reading for upper platen with untested specimen (mm)

## Test Method Q460B: Extrusion of preformed joint filler

### 1 Source

This Test Method is based on ASTM D545-84: *Preformed expansion joint fillers for concrete construction (non-extruding and resilient types)*, Section 7.3: *Extrusion, with only minor variations*.

### 2 Scope

This Test Method describes the procedure for determining the extrusion of preformed joint filler when subjected to a compressive force under specified conditions.

### 3 Apparatus

Where appropriate, the working tolerances of apparatus are contained in Table 1.

The following apparatus is required:

- 3.1 Compression testing machine, at least Class A as defined in AS 2193, with a moveable lower platen which travels at a uniform vertical rate of 1.3 mm/minute when measured loaded.
- 3.2 Metal mould with a base of 100 mm x 100 mm, a thickness of 11 mm, and three sides which are at least 50 mm high and 5 mm thick (Note 7.1).
- 3.3 Compression platen, having machined parallel bearing surfaces 100 mm x 100 mm and at least 5 mm thick (Note 7.1).
- 3.4 Vertical displacement measuring system, to allow the measurement of the vertical displacement at the centre of the specimen. The system can use a dial gauge conforming to the requirements of ISO 463 or JIS B 7503, which has a scale interval of 0.01 mm and a minimum range of 30 mm, or a displacement transducer of at least equal performance.
- 3.5 Force application assembly, incorporating a spherical seat.
- 3.6 Horizontal displacement measuring system, to allow the measurement of the horizontal displacement of the specimens. The system can use a dial gauge conforming to the requirements of ISO 463 or JIS B 7503, which has a scale interval of 0.01 mm and a minimum range of 10 mm, and is fitted with a disk shaped contact and mounted on a stand, or other suitable assembly to allow the horizontal displacement of the specimen to be measured.
- 3.7 Glass beaker, or similar heat resistant container having a capacity of approximately 5 L (Note 7.2).
- 3.8 Hotplate, with temperature control capable of maintaining a temperature of at least 110°C (Note 7.2).

### 4 Procedure

The procedure shall be as follows:

#### 4.1 Specimen preparation

- 4.1.1 For self-expanding cork joint fillers only, boil a 120 mm x 120 mm specimen for 1 hour (using the glass beaker and hot plate) and air dry for 24 hours.
- 4.1.2 Cut a test specimen, 100 mm square (tolerance  $\pm 0.5$  mm), from the preformed joint filler such that each edge is freshly cut.

## 4.2 Testing

- 4.2.1 Locate the mould and compression platen centrally on the lower platen of the testing machine. Place the vertical measuring system above the centre of the compression platen and record the dial gauge reading ( $d_1$ ).
- 4.2.2 Remove the compression platen and place the test specimen in the mould. Replace the platen and align it such that it is flush with the open side of the mould and is centrally located between the adjacent sides. Record the dial gauge reading ( $d_2$ ).
- 4.2.3 Locate the horizontal measuring system such that the contact is touching the free edge of the test specimen. Record the dial gauge reading ( $d_3$ ).
- 4.2.4 Using the load application assembly, apply and record the force necessary to compress the test specimen to 50 per cent of its original thickness (Note 7.3).
- 4.2.5 Immediately read and record the reading ( $d_4$ ) of the dial gauge in the horizontal system being used to measure extrusion of the test specimen.

## 5 Calculations

Calculations shall be as follows:

- 5.1 Calculate the extrusion as follows:

$$E = d_3 - d_4$$

where	$E$	=	extrusion (mm)
	$d_3$	=	dial gauge reading before compression (mm)
	$d_4$	=	dial gauge reading after compression (mm)

## 6 Reporting

The following shall be reported:

- 6.1 Extrusion to the nearest 0.01 mm.
- 6.2 The number of this Test Method, that is Q460B.

## 7 Notes on method

- 7.1 The compression platen is required to fit firmly into the mould without binding with any side.
- 7.2 The glass beaker and hotplate are only required when a self-expanding cork joint filler is to be tested.
- 7.3 The dial gauge reading corresponding to 50 per cent compression is calculated as follows:

$$d_{50} = d_1 + \frac{(d_2 - d_1)}{2}$$

where	$d_{50}$	=	dial gauge or transducer reading corresponding to 50% compression (mm)
	$d_1$	=	dial gauge reading for upper platen before testing (mm)
	$d_2$	=	dial gauge reading for upper platen with untested specimen (mm)

**Table 1 – Working tolerances for apparatus**

<b>Apparatus</b>	<b>Value</b>	<b>Tolerance</b>
<b>Mould – base</b>		
Width (mm)	100	+ 0.4, - 0.0
Length (mm)	100	+ 0.4, - 0.0
Thickness (mm)	11	+ 0.4, - 0.0
<b>Mould – sides</b>		
Height (mm)	50	+ 0.4, - 0.0
Thickness (mm)	5	+ 0.4, - 0.0
<b>Compression platen</b>		
Width (mm)	100	+ 0.4, - 0.0
Length (mm)	100	+ 0.4, - 0.0
Thickness (mm)	5	minimum



## Test Method Q460C: Expansion of preformed self-expanding joint filler

### 1 Source

This Test Method is based on ASTM D545-84: *Preformed expansion joint fillers for concrete construction (non-extruding and resilient types)*, Section 7.1: *Expansion in boiling water, with only minor variations*.

### 2 Scope

This Test Method describes the procedure for determining the expansion of self-expanding joint filler in boiling water.

### 3 Apparatus

The following apparatus is required:

- 3.1 Glass beaker, or similar heat resistant container having a capacity of approximately 5 L.
- 3.2 Hotplate, with temperature control capable of maintaining a temperature of at least 110°C.
- 3.3 Digital calliper, with a resolution of at least 0.1 mm and conforming to the requirements of ISO 13385-1 or JIS B 7507.

### 4 Procedure

The procedure shall be as follows:

#### 4.1 Specimen preparation

Cut two test specimens, 114 mm square (tolerance  $\pm 2.5$  mm), from the self-expanding joint filler such that each edge is freshly cut.

#### 4.2 Testing

- 4.2.1 Measure and record the mean initial thickness of each test specimen ( $t_1$ ).
- 4.2.2 Half fill the beaker with water and bring to the boil.
- 4.2.3 Immerse one of the test specimens in the boiling water for 1 hour.
- 4.2.4 At the end of this period, remove the test specimen and allow it to cool at room temperature for 15 minutes.
- 4.2.5 Measure and record the mean thickness of the test specimen ( $t_2$ ).
- 4.2.6 Repeat Steps 4.2.2 to 4.2.5 for the second test specimen.

### 5 Calculations

Calculations shall be as follows:

- 5.1 Calculate the percentage expansion for each test specimen as follows:

$$E = \frac{100(t_2 - t_1)}{t_1}$$

where  $E$  = expansion (%)  
 $t_2$  = mean final thickness of test specimen (mm)  
 $t_1$  = mean initial thickness of test specimen (mm)

5.2 Calculate the expansion as the mean expansion for the two test specimens.

## **6 Reporting**

The following shall be reported:

6.1 Expansion of the self-expanding joint filler to the nearest 1%, and

6.2 The number of this Test Method, that is Q460C.

## Test Method Q460D: Accelerated weathering of preformed joint filler

### 1 Source

This Test Method is based on ASTM D545-67: *Preformed expansion joint fillers for concrete construction (non-extruding and resilient types)*, with only minor variations.

### 2 Scope

This Test Method describes the procedure for determining the weathering resistance of joint filler materials.

### 3 Apparatus

The following apparatus is required:

- 3.1 Drying oven, capable of maintaining a temperature of  $75 \pm 1^\circ\text{C}$ .
- 3.2 Cabinet, capable of maintaining a temperature between  $-10^\circ\text{C}$  and  $-20^\circ\text{C}$ .
- 3.3 Water bath, capable of maintaining a temperature between  $20^\circ\text{C}$  and  $40^\circ\text{C}$ .
- 3.4 Metal test container, at least 100 mm deep and 120 mm in diameter.
- 3.5 Glass beaker, or similar heat resistant container having a capacity of approximately 5 L (Note 6.1).
- 3.6 Hotplate, with temperature control capable of maintaining a temperature of at least  $110^\circ\text{C}$  (Note 6.1).
- 3.7 Clamps, for holding the test specimens in the metal test container.

### 4 Procedure

The procedure shall be as follows:

#### 4.1 Specimen preparation

- 4.1.1 For self-expanding cork joint fillers only, boil a 120 mm x 120 mm specimen for 1 hour (using the glass beaker and hot plate) and air dry for 24 hours.
- 4.1.2 Cut a test specimen, 100 mm square (tolerance  $\pm 0.5$  mm), from the preformed joint filler such that each edge is freshly cut.

#### 4.2 Testing

- 4.2.1 Place the two test specimens in the oven for a period of 7 days.
- 4.2.2 At the end of this period, remove the test specimens and immerse them in a partly filled beaker of water at room temperature for 24 hours.
- 4.2.3 Place the test specimens on edge in the metal test container and clamp them securely in position such that they are not in contact with each other.
- 4.2.4 Partly fill the container with water to a depth of 50 mm (half the depth of the test specimens), then place the container in the cabinet until the water has frozen.
- 4.2.5 Remove the container from the cabinet and partly immerse the container in the water bath until the ice in the test container has completely melted.
- 4.2.6 Repeat Steps 4.2.4 to 4.2.5 until 10 cycles have been completed.

- 4.2.7 At the completion of the last cycle, remove the test specimens from the container and allow them to stand at room temperature for 48 hours.
- 4.2.8 Examine each test specimen and record details of any evidence of disintegration.

## **5 Reporting**

The following shall be reported:

- 5.1 Evidence of disintegration of each test specimen, and
- 5.2 The number of this Test Method, that is Q460D.

## **6 Notes on method**

- 6.1 The glass beaker and hotplate are only required when a self-expanding cork joint filler is to be tested.

## Test Method Q460E: Resistance to heat degradation of closed cell foam joint filler

### 1 Source

This Test Method applies the principles of TfNSW Test Method T1154: *Resistance to heat degradation of closed cell foam joint filler*. It differs from this Test Method in details for the making and curing of the mortar blocks are included.

### 2 Scope

This Test Method describes the procedure for determining the resistance of closed cell foam joint filler to degradation from contact with hot poured joint sealant when using these materials together in a formed joint system.

### 3 Apparatus

The following apparatus is required:

- 3.1 Mortar moulds, 50 mm x 50 mm and 25 mm thick.
- 3.2 Glass plate, at least 150 mm x 150 mm.
- 3.3 Masking tape, 25 mm wide.
- 3.4 Scalpel, or similar sharp cutting tool.
- 3.5 Heating container and lid, made of metal with a diameter of approximately 100 mm, a depth of approximately 150 mm and a maximum wall thickness of 1 mm. The lid must have access holes for a thermometer and a mechanical stirrer.
- 3.6 Mechanical stirrer and stand.
- 3.7 Thermometer, a partial or total immersion thermometer or other suitable temperature measuring device having a temperature range of at least 0°C–300°C and graduated to 5°C or less with an uncertainty of no more than 5°C.
- 3.8 Oil bath, containing silicone oil or an oil with a flash point in excess of 285°C, equipped with a mechanical stirrer.
- 3.9 Ruler, with a scale interval of 0.5 mm.
- 3.10 Trowel, made of steel with a blade approximately 100 mm–150 mm long.
- 3.11 Tamper, made of a rubber compound with a Shore A hardness of  $80 \pm 10$  or of seasoned hardwood which has been immersed in paraffin wax at 200°C for 15 minutes. The tamper shall have a rectangular face, 13 mm x 25 mm, which is at right angles to the length of the tamper. A convenient tamper length is 125 mm to 150 mm.

### 4 Materials

The following materials are required:

- 4.1 Mould oil, a light oil such as Caltex Mould Oil 20 (Notes 7.1 and 7.2).
- 4.2 Hot poured joint sealant (Note 7.1).
- 4.3 Release agent, for example, Potash soap (Note 7.1).
- 4.4 General purpose cement (GP).

- 4.5 Sand.
- 4.6 Water.
- 4.7 Masking tape.

## **5 Procedure**

The procedure shall be as follows:

### **5.1 Preparation of cement mortar test blocks**

- 5.1.1 Lightly oil two moulds, base plates and covers.
- 5.1.2 Mix 1 part of GP cement with 1.5 parts of sand by mass, adding sufficient water to the mixture to produce a consistency suitable for tamping. Mix the mortar for approximately 3 minutes.
- 5.1.3 Fill both the moulds in two equal layers, compacting each layer fully using the tamper.
- 5.1.4 Strike off the excess mortar and smooth the surface using the trowel, then place the covers on the moulds.
- 5.1.5 Undertake initial curing and standard moist curing in accordance with AS 1012.8, Clause 1.9.
- 5.1.6 At the completion of at least 7 days standard moist curing, surface dry the mortar blocks so they are ready for the application of the release agent.

### **5.2 Preparation of hot poured joint sealing compound**

- 5.2.1 Heat the oil bath with the heating container fixed into position until the oil temperature is in the range 190°C - 220°C.
- 5.2.2 Melt approximately 250 g of hot poured joint sealant by placing of approximately 50 g pieces of the compound in the heating container at approximately 30 second intervals.
- 5.2.3 Place the lid on the container and insert the thermometer and mechanical stirrer.
- 5.2.4 Commence mixing the joint sealant and continue heating until its temperature is 190°C.

### **5.3 Specimen preparation**

- 5.3.1 Cut a test specimen 50 mm long and 25 mm wide from a sample of closed cell foam filler.

### **5.4 Testing**

- 5.4.1 Apply release agent to one 50 mm square face of each cement mortar block.
- 5.4.2 Place the cement blocks on the glass plate such that the coated surfaces are facing each other in the vertical plane and are separated by at least the thickness of the test specimen. Locate the test specimen centrally between the blocks such that a face formed by its 50 mm length and thickness is in contact with the glass plate.
- 5.4.3 Apply sufficient pressure to the mortar blocks to ensure there is intimate contact between the blocks and the foam filler. Wrap masking tape around the blocks and the foam filler to form a reservoir 25 mm deep, 50 mm long and having a width equal to the thickness of the test specimen.
- 5.4.4 Rapidly fill the reservoir with hot poured sealant and allow the mould to stand for 24 hours at 16°C to 25°C.
- 5.4.5 Remove the filler and sealant from the mould.

- 5.4.6 Place the filler / sealant combination on a flat surface and cut through the two compounds along a line at right angles to the filler / sealer interface.
- 5.4.7 Measure the amount of penetration of the sealant into the filler at several locations along the interface.

## **6 Reporting**

The following shall be reported:

- 6.1 Mean depth of penetration to the nearest 1 mm as the resistance to heat degradation, and
- 6.2 The number of this Test Method, that is Q460E.

## **7 Notes on method**

- 7.1 Before handling oil, release agent or joint sealant, the operator should consult the relevant SDS.
- 7.2 Other mould oils such as Shellmould P5, Reochem Mould Oil 20 and Caltex Mould Oil 222 have also been found to be suitable.

## Test Method Q460F: Resistance to disintegration of preformed cork joint filler

### 1 Source

This Test Method is based on ASTM D545-84: *Preformed expansion joint fillers for concrete construction (non-extruding and resilient types)*, Section 7.4: *Boiling in hydrochloric acid, with only minor variations*.

### 2 Scope

This Test Method describes the procedure for assessing the effectiveness of the bonding materials in preformed cork joint fillers used to bond the granulated particles of natural cork.

### 3 Apparatus

The following apparatus is required:

- 3.1 Glass beaker, having a capacity of at least 5 L (Note 7.1).
- 3.2 Fume cabinet.
- 3.3 Hotplate, with temperature control capable of maintaining a temperature of at least 110°C (Note 7.1).

### 4 Reagent

The following reagent is required:

- 4.1 Hydrochloric acid, 12.4M (concentrated) (Note 7.2).

### 5 Procedure

The procedure shall be as follows:

#### 5.1 Specimen preparation

- 5.1.1 For self-expanding cork joint fillers only, boil a 120 mm x 120 mm specimen for 1 hour (using the glass beaker and hot plate) and air dry for 24 hours.
- 5.1.2 Cut a test specimen, 100 mm square (tolerance  $\pm 0.5$  mm), from the preformed joint filler such that each edge is freshly cut.

#### 5.2 Testing

- 5.2.1 Half fill the beaker with hydrochloric acid and bring the acid to the boil using a hotplate located in a fume cabinet with the fume cabinet extraction system operating.
- 5.2.2 Immerse the test specimen in the boiling hydrochloric acid for 1 hour.
- 5.2.3 Remove the test specimen from the beaker and wash the test specimen under running water.
- 5.2.4 Examine the test specimen and note any signs of disintegration, delamination, porosity or dislodged particles of cork.
- 5.2.5 Use the fingers to test for friability, lack of resiliency and resistance to abrasion by rubbing.



## **6 Reporting**

The following shall be reported:

- 6.1 Any defects, ignoring discolouration and slight swelling, and
- 6.2 The number of this Test Method, that is Q460F.

## **7 Notes on method**

- 7.1 The glass beaker and hotplate are only required when a self-expanding cork joint filler is to be tested.
- 7.2 Before handling concentrated hydrochloric acid, the operator should consult the relevant SDS.

## Test Method Q461: Durability of sealant

### 1 Source

This Test Method is based on TfNSW Test Method T1192-1992: *Adhesion of sealant*, and TfNSW Test Method T1193-1991: *Accelerated aging of cured sealant*, with only minor variations.

### 2 Scope

This Test Method describes the procedure to assess the durability of sealant bonded to a substrate when tested for adhesion and cohesion. The Test Method is applicable to sealant used to seal sawn joints in concrete pavements.

### 3 Apparatus

The following apparatus is required:

- 3.1 Oven, capable of maintaining a temperature of  $70 \pm 3^\circ\text{C}$  within all of the working space or a defined area of sufficient size to accommodate the test specimen assembly.
- 3.2 Refrigerated cabinet, capable of maintaining a temperature of  $0 \pm 3^\circ\text{C}$ .
- 3.3 Water bath, capable of maintaining a temperature of  $35 \pm 1^\circ\text{C}$  and of sufficient size to allow immersion of the test specimen assembly to a depth of at least 20 mm below the surface.
- 3.4 Cabinet, capable of maintaining a temperature of  $23 \pm 2^\circ\text{C}$ .
- 3.5 Testing machine, capable of applying tensile and compressive forces at a rate of travel of 10 mm/minute.
- 3.6 Mould, made from non-absorbent material that will not react with concrete and be able to cast a concrete prism, 50 mm x 140 mm and about 200 mm long.
- 3.7 Saw, diamond tipped masonry saw.
- 3.8 Spacer blocks, made from non-absorbent material with machined surfaces 13 mm x 20 mm x 31 mm.
- 3.9 Backing foam, 15 mm thick.
- 3.10 Clamps, for example G clamps or quick release clamps.
- 3.11 Tension and compression testing jig, as shown in Figure 1.
- 3.12 Digital calliper, with a resolution of at least 0.1 mm and conforming to the requirements of ISO 13385-1 or JIS B 7507.
- 3.13 Vertical displacement measuring system, to measure the extension and compression of the moulded sealant. The system can use a dial gauge conforming to the requirements of ISO 463 or JIS B 7503, with a scale interval of 0.01 mm and a minimum travel of 25 mm, or a displacement transducer of at least equal performance.

### 4 Materials

The following materials are required:

- 4.1 Release agent, for example, Potash Soap.
- 4.2 Concrete.
- 4.3 Paper towel.

## **5 Procedure**

The procedure shall be as follows:

### **5.1 Preparation of concrete blocks**

- 5.1.1 Mould a concrete prism using at least 40 MPa concrete and allow it to cure for at least 28 days in accordance with AS 1012.8.1.
- 5.1.2 Cut 6 concrete blocks from the prism using the masonry saw, such that each block has 2 flat cut faces, 50 mm x 140 mm, and is approximately 25 mm thick.
- 5.1.3 Condition the blocks using one of the following methods:
  - a) dry blocks: allow the blocks to dry at room temperature for 7 days after cutting
  - b) dry abraded blocks: allow the blocks to dry at room temperature for 7 days after cutting, then blast one flat surface (the bonding face) on each block with grit abrasive, or
  - c) saturated surface-dry blocks: immerse the blocks in water at room temperature for 2 hours, then remove the blocks and blot them dry with folded paper towel to remove surface water.

### **5.2 Moulding of sealant**

Mould 3 specimens of sealant as follows:

- 5.2.1 Apply the release agent to a 13 mm x 31 mm surface of each spacer block, that is, the face that will contact the sealant.
- 5.2.2 Cut a strip from the 15 mm thick backing foam, 100 mm x 19 mm (tolerance  $\pm 0.5$  mm). Apply release agent to the 100 mm x 15 mm face that will contact the sealant.
- 5.2.3 Assemble the concrete blocks, spacer blocks and foam using the clamps to hold the components in place such that a formed cavity 100 mm long, 13 mm wide and 12 mm deep between the blocks after compressing the foam to a thickness of 13 mm. Refer to Figure 2.
- 5.2.4 Prepare the sealant according to the manufacturer's instructions and fill the cavity with sealant to the top of the spacer blocks.
- 5.2.5 Allow the sealant to cure for 7 days at  $23 \pm 2^\circ\text{C}$  before removing the spacer blocks and backing foam.

### **5.3 Aging**

Age the 3 specimens of sealant as follows:

- 5.3.1 Air cure the test specimen assemblies in the oven for 72 hours at  $70 \pm 3^\circ\text{C}$ .
- 5.3.2 Air cure the test specimen assemblies in the refrigerated cabinet for 24 hours at  $0 \pm 3^\circ\text{C}$ .
- 5.3.3 Submerge the test specimen assemblies in the water bath and cure for 48 hours at  $35 \pm 1^\circ\text{C}$ .
- 5.3.4 Air cure the test specimen assemblies for 24 hours at  $23 \pm 2^\circ\text{C}$ .

### **5.4 Testing**

- 5.4.1 Measure the distance between the faces of the concrete blocks for one of the test specimen assemblies by taking at least three measurements along the top surface of the sealant and three measurements along the bottom surface.
- 5.4.2 Place the test specimen assembly in the testing jig and secure the concrete blocks firmly in the jaws.

- 5.4.3 Attach the testing jig to the testing machine maintaining the distance between the blocks as measured in Step 5.4.1.
- 5.4.4 Cycle the sealant specimen through 100 cycles of 70 per cent extension and 50 per cent compression as measured by the displacement measuring system (Note 7.2).
- 5.4.5 During the extension and compression cycles, monitor the specimen for cohesion failure or adhesion failure as follows:
- a) cohesion failure - assess the extent of any cracking of the specimen during compression using a fine wire such as a straightened paper clip to probe the depth of any crack. Where the degree of failure is equal to or greater than 10 percent of the cross-sectional area of the specimen, record the specimen as a fail, or
  - b) adhesion failure - assess the extent of any debonding at both sealant/concrete block interfaces. Again, use a fine wire such as a straightened paper clip to probe the extent of any debonding. Where the degree of failure at either interface equal to or greater than 10 percent of the cross-sectional area of the specimen, record the specimen as a fail.
- 5.4.6 Repeat Steps 5.4.1 to 5.4.5 for the remaining two test specimen assemblies. If no more than one specimen fails the test, the sealant is acceptable. Otherwise, the sealant is unacceptable.

## **6 Reporting**

The following shall be reported:

- 6.1 Durability of the sealant as either acceptable or unacceptable, and
- 6.2 The number of this Test Method, that is Q461.

## **7 Notes on method**

- 7.1 Before handling release agent or concrete, the operator should consult the relevant SDS.
- 7.2 The extension and compression are determined from the specimen width measured in Step 5.4.1.

Figure 1 – Testing jig

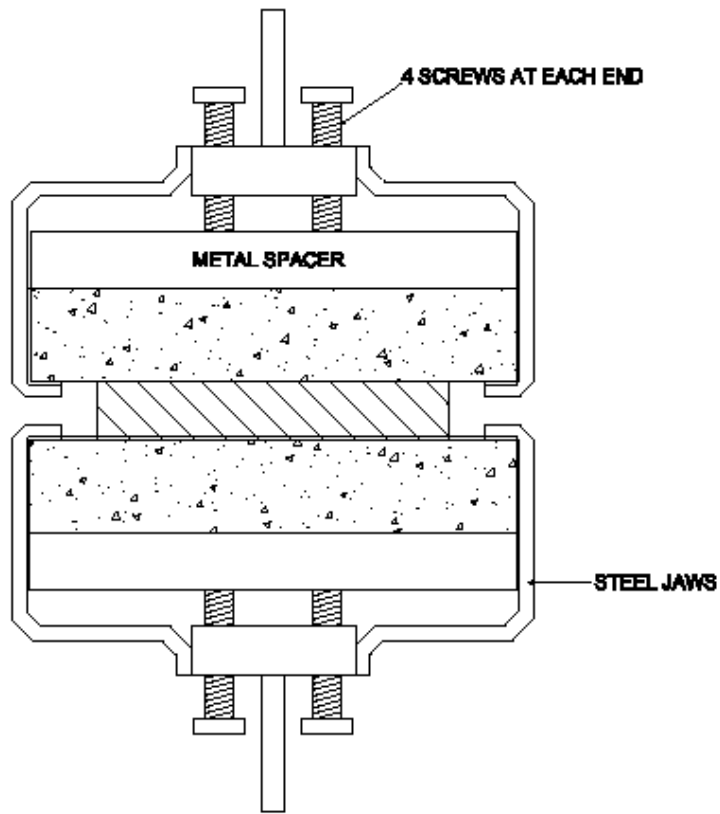

**LEGEND**

-  **CONCRETE BLOCK**
-  **SEALANT**

Figure 2 – Test specimen assembly

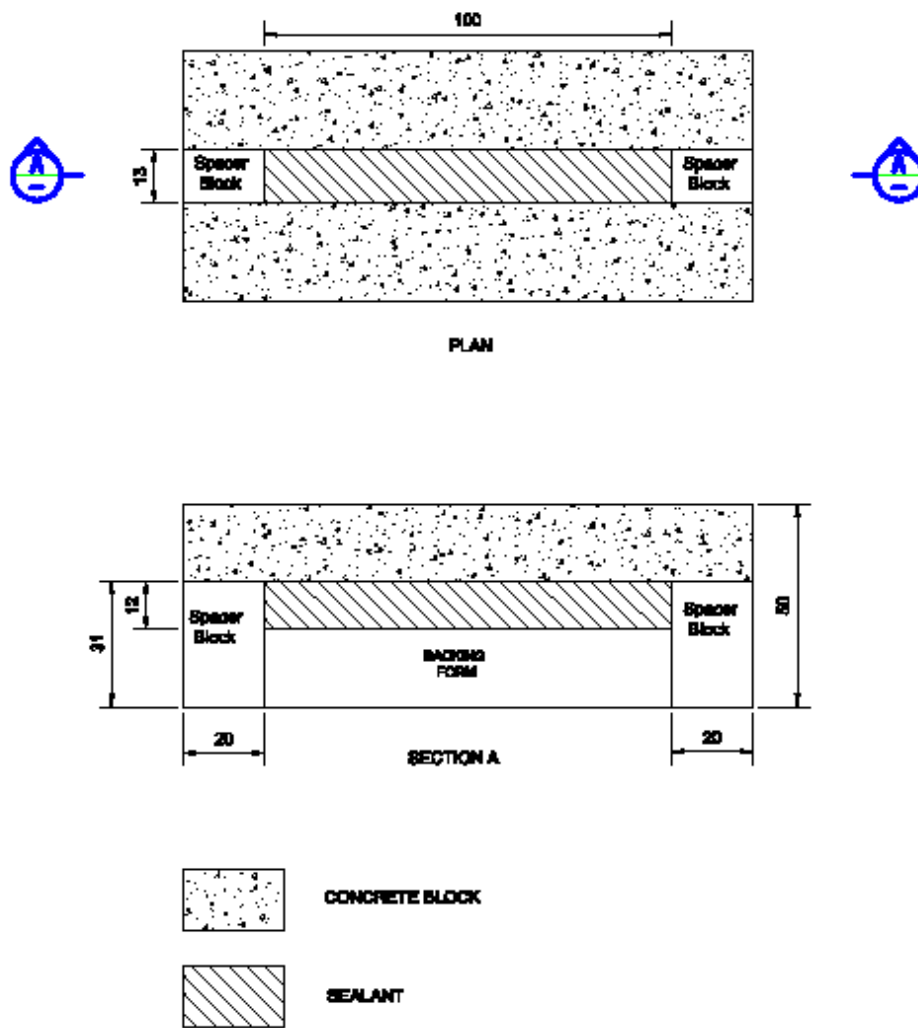

## Test Method Q473: Density of hardened concrete – water displacement

### 1 Source

This Test Method combines the principles of TfNSW Test Method T368 – *Draft: Dressing of voids in concrete specimens and adjustment for embedded steel*, and of AS 1012.12.2: *Determination of mass per unit volume of hardened concrete – Water displacement method*; with only minor variations.

### 2 Scope

This Test Method describes the procedure for the determination of the density of hardened concrete using a water displacement method. The Test Method allows for testing of cored specimens. The Test Method provides for the inclusion of surface voids in the calculation of density and for the adjustment of the measured value for any embedded reinforcing steel and is applicable to specimens having a diameter of 100 mm or larger.

### 3 Apparatus

The following apparatus is required:

- 3.1 Balance of suitable capacity, with a resolution of 1 g, with a limit of performance within the range of  $\pm 5$  g and capable of below balance weighing.
- 3.2 Balance bench, equipped with a hole for below balance weighing.
- 3.3 Thermometer, total immersion or other suitable temperature measuring device having a temperature range which includes the test temperature, and graduated to 1°C or less with an uncertainty of no more than 1.0°C.
- 3.4 Water container, fitted with an overflow and of suitable dimensions to allow the complete immersion of the concrete specimen without contacting any part of the container.
- 3.5 Attachment, a non-absorbent device to suspend the concrete specimen, for example nylon or wire loop or wire support frame.
- 3.6 Basket, wire basket of suitable mesh and capacity to hold any reinforcing steel.
- 3.7 Digital calliper, with a resolution of at least 0.1 mm and conforming to the requirements of ISO 13385-1 or JIS B 7507.
- 3.8 Steel rule.
- 3.9 Putty knife or scraper.
- 3.10 Masonry or diamond saw for trimming specimens.

### 4 Materials

The following material is required:

- 4.1 Filler, which is non-absorbent and mechanically stable to allow easy shaping, yet able to retain its shape during handling and immersion, for example plasticine or wax (Note 9.1).
- 4.2 Absorbent cloth.

## 5 Procedure

The procedure shall be as follows:

### 5.1 Dressing of voids

- 5.1.1 Pre-condition the specimen using the wet conditioning procedure in accordance with AS 1012.14.
- 5.1.2 Remove the surplus water from the surface of the wet conditioned specimen using an absorbent cloth and continue drying until the surface appears just damp.
- 5.1.3 Determine the mass of the specimen ( $m_1$ ).
- 5.1.4 Examine the specimen to identify which voids, if any, meet the criteria for filling as follows:
  - a) voids with a maximum dimension less than 5 mm need not be filled
  - b) voids with a maximum dimension between 5 and 15 mm are filled if there are more than 10 on the surface, or
  - c) voids with a maximum dimension greater than 15 mm are filled.
- 5.1.5 For a specimen containing reinforcing steel embedded in the surface which can be removed without damaging the specimen, remove the steel and fill any air voids adjoining the resultant cavity with filler. Do not fill the cavity left by the steel itself or any imprints from deformation patterns on the steel bar.
- 5.1.6 Remove any non-concrete materials such as bitumen using a scraper.
- 5.1.7 Where required, remove surface texture and fractured surfaces using a masonry saw. The removal of concrete is limited to a maximum of 10 mm from each end.
- 5.1.8 Fill any surface voids which require filling by shaping the filler to match the specimen's contour as if complete compaction had been achieved (Note 9.2).
- 5.1.9 Determine the diameter ( $d$ ) of the specimen from two diameters measured to the nearest 0.1 mm at right angles to each other.
- 5.1.10 Determine the height ( $h$ ) of the specimen to the nearest 1 mm.

### 5.2 Conditioning of specimens

- 5.2.1 Immerse the specimen in water at a temperature of  $23 \pm 2^\circ\text{C}$  for approximately 1 hour.
- 5.2.2 Remove the specimen from the water, remove surplus water from its surface using an absorbent cloth and continue drying until the surface appears just damp.
- 5.2.3 Determine the mass of the specimen and filler in the saturated surface dry condition ( $m_2$ ).

### 5.3 Density measurement

- 5.3.1 Place the container directly below the hole in the balance bench, fill it with water until water escapes from the overflow and allow the excess water to run to waste.
- 5.3.2 When water has ceased dripping from the overflow, fit the attachment to the balance, allow the remainder of the attachment to be immersed in the water container, and zero the balance.
- 5.3.3 Using the attachment, suspend the specimen from the balance and gently lower it into the water container until completely immersed, taking care to ensure that the suspended specimen hangs free of the sides and bottom of the container.



- 5.3.4 Add additional water, if necessary, until water escapes from the overflow, and allow the excess water to run to waste.
- 5.3.5 When water has ceased dripping from the overflow, determine the mass of the immersed specimen and filler ( $m_3$ ).
- 5.3.6 Record the temperature of the water in the container to the nearest 1°C ( $t_1$ ).

#### 5.4 Adjustment for reinforcing steel

- 5.4.1 Remove the specimen from the container and, for a specimen containing embedded reinforcing steel, remove this by breaking the concrete.
- 5.4.2 Determine the mass of the reinforcing steel ( $m_4$ ).
- 5.4.3 Suspend the wire basket below the balance and add additional water, if necessary, until water escapes from the overflow, and allow the excess water to run to waste.
- 5.4.4 Zero the balance.
- 5.4.5 Remove the wire basket and place any steel in the basket.
- 5.4.6 Suspend the wire basket and steel from the balance and completely immerse them in the water.
- 5.4.7 Agitate the wire basket to remove any entrapped air.
- 5.4.8 Add additional water, if necessary, until water escapes from the overflow, and allow the excess water to run to waste.
- 5.4.9 When water has ceased dripping from the overflow, determine the mass of the immersed reinforcing steel ( $m_5$ ).
- 5.4.10 Record the temperature of the water in the container to the nearest 1°C ( $t_2$ ).

## 6 Calculations

Calculations shall be as follows:

- 6.1 Calculate the mean specimen diameter (D).
- 6.2 Calculate the density of concrete for the core specimen as follows:

$$\rho_c = \frac{m_1 - m_4}{\frac{m_2 - m_3}{\rho_{w1}} - \frac{m_4 - m_5}{\rho_{w2}}}$$

- where
- $\rho_c$  = density of concrete (t/m<sup>3</sup>)
  - $\rho_{w1}$  = density of water at test temperature  $t_1$  (t/m<sup>3</sup>) (Table 1)
  - $\rho_{w2}$  = density of water at test temperature  $t_2$  (t/m<sup>3</sup>) (Table 1)
  - $m_1$  = mass of saturated surface-dry specimen (g)
  - $m_2$  = mass of moist specimen and filler (g)
  - $m_3$  = mass of fully immersed specimen and filler (g)
  - $m_4$  = mass of reinforcing steel (g)
  - $m_5$  = mass of fully immersed reinforcing steel (g)

## 7 Reporting

The following shall be reported:

### 7.1 Description of specimen providing information on:

- a) Specimen type, that is, core
- b) Moisture condition when tested, that is, saturated surface-dry
- c) Presence or not of reinforcing steel and, when present, whether steel was removed before or after testing, and
- d) Trimming of any fractured core surface.

### 7.2 Test results:

- a) Density of concrete to the nearest 0.01 t/m<sup>3</sup>
- b) Specimen diameter to the nearest 0.1 mm, and
- c) Specimen height to the nearest 1 mm.

### 7.3 The number of this Test Method, that is Q473.

## 8 Notes on method

8.1 Before handling any filler, the operator should consult the relevant SDS.

8.2 If voids are to be filled in a fractured surface at the bottom of a core, it is acceptable to trim the face by saw-cutting, provided there will be no significant change to the density of the specimen due to the removal of poorly compacted concrete.

**Table 1 – Density of Water**

Temperature (°C)	Density (t/m <sup>3</sup> )	Temperature (°C)	Density (t/m <sup>3</sup> )	Temperature (°C)	Density (t/m <sup>3</sup> )
0	0.9998	14	0.9992	28	0.9962
1	0.9999	15	0.9991	29	0.9959
2	0.9999	16	0.9989	30	0.9957
3	1.0000	17	0.9988	31	0.9953
4	1.0000	18	0.9986	32	0.9950
5	1.0000	19	0.9984	33	0.9947
6	0.9999	20	0.9982	34	0.9944
7	0.9999	21	0.9980	35	0.9940
8	0.9999	22	0.9978	36	0.9937
9	0.9998	23	0.9975	37	0.9933
10	0.9997	24	0.9973	38	0.9930
11	0.9996	25	0.9970	39	0.9926
12	0.9995	26	0.9968	40	0.9922
13	0.9994	27	0.9965		

## Test Method Q474: Dowel pull-out test

### 1 Source

This Test Method is based on TfNSW Test Method T366: *Dowel pull-out test*, with only minor variations.

### 2 Scope

This Test Method describes the procedure for the determination of the suitability of dowel debonder coatings, by measuring the tensile strength of the bond developed when a coated steel dowel is embedded in concrete. The Test Method is applicable to steel dowels used in concrete road pavements for load transfer across joints.

### 3 Apparatus

The following apparatus is required:

- 3.1 Concrete cylinder moulds, having a diameter between 145 mm and 155 mm and capable of moulding specimens that are right cylinders having height between 1.95 and 2.05 times the mean diameter of the specimen.
- 3.2 Internal vibrator, having a vibrating element that operates at a frequency of at least 115 Hz, a minimum diameter of 15 mm, a maximum diameter of 30 mm and is powered by a 240 volt, 50 Hz electric motor with a minimum rating of 1500 watts.
- 3.3 Scoop and wooden float.
- 3.4 Digital calliper, with a resolution of at least 0.1 mm and conforming to the requirements of ISO 13385-1 or JIS B 7507.
- 3.5 Steel rule, with a scale interval of 0.5 mm.
- 3.6 Testing machine, capable of applying a tensile force at a constant rate of 0.5 mm per minute and conforming to the requirements of AS 2193, Class C.
- 3.7 Vertical displacement measurement system, to measure the vertical displacement of the dowel bar. The system can use a dial gauge conforming to the requirements of ISO 463 or JIS B 7503 with a scale interval of 0.01 mm and a minimum travel of 10 mm, or a displacement transducer of at least equal performance.

### 4 Procedure

The procedure shall be as follows:

#### 4.1 Sampling

- 4.1.1 Sample fresh concrete from the works or mix concrete in the laboratory conforming to the relevant Technical Specification requirements, in accordance with AS 1012.1 or AS 1012.2 as appropriate.

#### 4.2 Moulding and curing

Mould and cure two test specimens as follows:

- 4.2.1 Half fill each mould with concrete and insert a dowel which has been treated with the debonder coating. Locate the dowel centrally into the mould so that it touches the bottom of the mould.

- 4.2.2 Compact the concrete by inserting the vibrator element in at least two locations, approximately at the quarter points of one diameter, ensuring that the element does not come in contact with the sides or base of the mould.
- 4.2.3 After inserting the element, continue compacting the concrete until the surface becomes relatively smooth in appearance, and substantial air bubbles cease breaking the surface. Do not unduly prolong the vibration beyond this point. At this time, slowly extract the vibrator element over a period of 3 seconds or more.
- 4.2.4 Complete the filling of each mould by placing sufficient concrete in the last layer to overfill the mould when compacted.
- 4.2.5 Compact the second layer in accordance with Steps 4.2.2 and 4.2.3, inserting the vibrator to a depth which just penetrates the first layer (Note 7.1)
- 4.2.6 Strike off and smooth the surface of the concrete using the wooden float.
- 4.2.7 Cure the concrete cylinders for 7 days in accordance with AS 1012.8.1 Clause 9, except that after initial curing, test specimens are not demoulded before being placed under standard moist-curing conditions.

### 4.3 Testing

- 4.3.1 At the completion of the 7 days curing, demould the test specimens and remove the debonding coating from the exposed part of the dowels.
- 4.3.2 For each test specimen, measure the dowel diameter ( $d$ ) to the nearest 0.1 mm and concrete test specimen height ( $l$ ) to the nearest 0.5 mm at several locations.
- 4.3.3 Position a test specimen in the testing machine and locate the displacement measuring system such that the movement of the dowel relative to the concrete can be measured.
- 4.3.4 Apply force to the test specimen until a dowel displacement of at least 0.25 mm is achieved.
- 4.3.5 Record the maximum applied force ( $P$ ) to the nearest 10 kN.
- 4.3.6 Repeat Steps 4.3.3 to 4.3.5 for the second test specimen.

## 5 Calculation

Calculations shall be as follows:

- 5.1 Calculate the mean dowel diameter and mean concrete test specimen height (dowel embedded length).
- 5.2 Calculate the bond strength for each test specimen as follows:

$$S = \frac{P}{\pi dl}$$

- where
- $S$  = bond strength (MPa)
  - $P$  = maximum applied force (kN)
  - $d$  = mean dowel diameter (mm)
  - $l$  = mean dowel embedded length (concrete test specimen height) (mm)

- 5.3 Calculate the mean bond strength.

## **6 Reporting**

The following shall be reported:

- 6.1 Type of debonder coating used and the method of application.
- 6.2 Nominal diameter of dowels under test (mm).
- 6.3 Mean bond strength to the nearest 0.1 MPa.
- 6.4 The number of this Test Method, that is Q474.

## **7 Notes on method**

- 7.1 If, after partial compaction of the layer, it is apparent that the mould will not be filled, add additional concrete and then complete compaction.

## Test Method Q475: Tie bar pull-out test

### 1 Source

This Test Method was developed in-house using techniques evolved through departmental research investigations.

### 2 Scope

This Test Method describes a field procedure for the determination of the tensile strength of the bond developed between a tie bar and the concrete into which it is embedded. This Test Method is applicable to tie bars used at construction joints and sawn joints in concrete road pavements.

### 3 Apparatus

The following apparatus is required:

- 3.1 Hollow ram jack, capable of applying a tensile force at a constant rate of 10 mm per minute and having a force indicator which conforms to the requirements of AS 2193, Class C.
- 3.2 Clamping mechanism, to allow load transfer from the jack to the tie bar.
- 3.3 Steel shims, of appropriate size for the jack, for example 150 mm x 25 mm x 1 mm.
- 3.4 Digital calliper, with a resolution of at least 0.1 mm and conforming to the requirements of ISO 13385-1 or JIS B 7507.
- 3.5 Steel rule, with a scale interval of 0.5 mm.

### 4 Procedure

The procedure shall be as follows:

- 4.1 Ensure that the pavement edge which is adjacent to the tie bar and which will come into contact with the jack is free of concrete projections.
- 4.2 For the tie-bar of nominal length ( $l_1$ ), measure the tie bar exposed length ( $l_2$ ) to the nearest 1 mm and the tie bar diameter ( $d$ ) to the nearest 0.1 mm at several locations.
- 4.3 Position the jack on the tie bar using any necessary supports to ensure that the base of the jack makes uniform contact with the pavement edge and the jack is centrally located about the bar using the necessary supports (Note 7.1).
- 4.4 Attach the clamping mechanism to the tie bar and apply a tensile force to the bar at a rate of 10 mm per minute.
- 4.5 Continue applying the force to the bar until a displacement of 5–10 mm relative to the pavement edge is achieved. Record the maximum force ( $P$ ) to the nearest 10 kN.

## 5 Calculation

Calculations shall be as follows:

5.1 Calculate the mean tie bar diameter and mean tie bar exposed length.

5.2 Calculate the bond strength as follows:

$$S = \frac{P}{\pi d(l_1 - l_2)}$$

where	$S$	=	bond strength (MPa)
	$P$	=	maximum applied force (kN)
	$d$	=	mean tie bar diameter (mm)
	$l_1$	=	nominal tie bar length (mm)
	$l_2$	=	mean tie bar exposed length (mm)

## 6 Reporting

The following shall be reported:

6.1 Nominal diameter and bonded length of the tie bar (mm).

6.2 Age of the concrete at the time of testing (days).

6.3 Bond strength to the nearest 0.1 MPa.

6.4 The number of this Test Method, that is Q475.

## 7 Notes on method

7.1 Where irregularities in the shape of the pavement edge will not allow the jack to act parallel to the tie bar, use steel shims to pack the base of the jack.

## Test Method Q477: Foreign materials content of recycled crushed concrete

### 1 Source

This Test Method is based on TfNSW Test Method T276: *Foreign Materials Content of Recycled Crushed Concrete*. It differs from this Test Method by providing for the identification of two additional foreign material types.

### 2 Scope

This Test Method sets out the procedure for the determination of the foreign materials content in a sample of recycled crushed concrete.

### 3 Apparatus

The following apparatus is required:

- 3.1 Sieve, 4.75 mm conforming to ISO 3310.
- 3.2 Sieve brush.
- 3.3 Drying oven of suitable capacity, having a temperature of 45 - 50°C and conforming to AS 1289.0.
- 3.4 Balance of suitable capacity, having a resolution of at least 0.1 g and with a limit of performance within the range of  $\pm 0.5$  g.
- 3.5 Suitable metal dishes.

### 4 Definitions

For this Test Method, the following definition shall apply:

- 4.1 Constant mass – when the difference between successive weighings, after a further 4 hours drying at 45 - 50°C, is not more than 1 percent of the total of the previous moisture losses.

### 5 Procedure

The procedure shall be as follows:

- 5.1 Prepare a bulk sample in accordance with Section 4 of Test Method Q101 to produce a representative subsample of about 6000 g.
- 5.2 Place the subsample in the oven and dry to a constant mass (Note 7.1).
- 5.3 Allow the subsample to cool to ambient temperature and determine the mass of the subsample ( $m_1$ ).
- 5.4 Sieve the subsample by hand through the 4.75 mm sieve, in accordance with Test Method Q101H.
- 5.5 Sort and separate by hand all foreign material retained on the 4.75 mm sieve and classify it in accordance with Table 1.
- 5.6 Determine the mass of each foreign material type retained on the 4.75 mm sieve ( $m_i$ ).



## 6 Calculations

Calculations shall be as follows:

6.1 Calculate the percentage of each foreign material type as follows:

$$F_i = \frac{m_i}{m_1} 100$$

where  $F_i$  = percentage of each foreign material type retained on the 4.75 mm sieve (%)

$m_i$  = mass of each foreign material type (g)

$m_1$  = mass of subsample (g)

## 7 Reporting

The following shall be reported:

7.1 Percentage of each foreign material type retained on the 4.75 mm sieve to the nearest 0.1%, and

7.2 The number of this Test Method, that is Q477.

**Table 1 – Classification of foreign material types**

Foreign material type	Material retained
1	Brick and glass
2	Metal, ceramics and slag (other than blast furnace slag)
3	Plaster, clay lumps and other friable material
4	Rubber, plastic, bitumen (not part of asphalt), paper, cloth, paint, wood and other vegetable matter
5	Asphalt

## Test Method Q478: Stability of super-workable concrete

### 1 Source

This Test Method is based on ASTM C1611: *Standard test method for slump flow of self-consolidating concrete, Appendix X1: Relative measure of flow rate, viscosity and stability*, with only minor variations.

### 2 Scope

This Test Method describes the procedure for assessing the stability of super-workable concrete by examining the concrete mass and perimeter after the determination of slump flow.

### 3 Procedure

The procedure shall be as follows:

- 3.1 Perform the slump flow of a sample in accordance with Test Method AS 1012.3.5.
- 3.2 When the concrete has stopped flowing, visually examine the concrete mixture by observing the distribution of the coarse aggregate within the concrete mass, the distribution of the mortar fraction particularly around the perimeter, and the bleeding characteristics of the concrete (Note 5.1).
- 3.3 Assign a visual stability index (VSI) using the criteria in Table 1.

### 4 Reporting

The following shall be reported:

- 4.1 VSI value.
- 4.2 VSI value description.
- 4.3 The number of this Test Method, that is Q478.

### 5 Notes on method

- 5.1 Examples of VSI values may be found in on ASTM C1611: *Standard test method for slump flow of self-consolidating concrete, Appendix X1: Relative measure of flow rate, viscosity and stability*, Figures X1.1 to X1.4.

**Table 1 – Visual stability index values**

VSI value	Description	Criteria
0	Highly stable	No evidence of segregation or bleeding
1	Stable	No evidence of segregation and slight bleeding observed as a sheen on the concrete mass
2	Unstable	A slight mortar halo $\leq 10$ mm around the perimeter and/or aggregate pile in the centre of the concrete mass
3	Highly unstable	Clearly segregating by evidence of a large mortar halo $> 10$ mm around the perimeter and/or a large aggregate pile in the centre of the concrete

## Test Method Q479: Water retention of concrete – filtration

### 1 Source

This Test Method is based on Concrete Institute of Australia (2012) 'Appendix A.3: BAUER filtration test' in 'CIA Z17: Recommended Practice, Tremie Concrete for Deep Foundations', 1<sup>st</sup> edition, Concrete Institute of Australia and BAUER Concrete filter press, Bauer Operating Instruction [printed instruction] with only minor variations.

### 2 Scope

This Test Method is used to measure the ability of a concrete with a maximum coarse aggregate size of 20 mm or less to retain its water under pressure. This test determines the amount of water de-filtered when concrete is subjected to a certain applied pressure. The Test Method was further developed from the filtration test procedure for bentonite and is similar to the filtration test in accordance with the Austrian Guide for soft concrete (Note 9.1). The filtration test can be used for mix design development and approval and is not generally used for production testing. Testing usually starts immediately after mixing of concrete. The test results describe the filtration loss and the filter cake thickness.

### 3 Apparatus

Examples of the apparatus are shown in Concrete Institute of Australia (2012).

The following apparatus is required:

- 3.1 Filter press unit (Note 9.2), consisting of:
  - a) Test cylinder, steel cylinder with non-absorptive surfaces and of rigid shape, 300 mm long and 80 mm internal diameter.
  - b) Lower part, steel end with central aperture for water release. Able to contain two sealing rings, screen and filter paper. A screen with an aperture size of about 0.250 mm has been found to be suitable.
  - c) Top part, steel end with pressure regulator, connection for compressed air and gauge to indicate pressure and sealing ring. With the pressure gauge conforming to the accuracy requirements of AS 1349 for industrial gauges.
  - d) Frame, to contain the assembled filter press and with a locking mechanism to hold the filter press in-place and apply sufficient pressure to seal the filter press. There should be sufficient space under the filter press to place a measuring cylinder to capture the filtered water.
- 3.2 Scoop.
- 3.3 Rod, conforming to requirements of AS 1012.3.1.
- 3.4 Compressed air supply. Supply may be provided by a compressor or cylinders.
- 3.5 Beaker, 250 mL capacity.
- 3.6 Measuring cylinder, 50 mL or 100 mL capacity with 2 mL scale.
- 3.7 Timer, with a resolution of 1 second.
- 3.8 Ruler, with a scale interval of 1 mm.

## 4 Materials

The following materials are required:

- 4.1 Filter paper, Whatman Grade 50 or equivalent with a diameter of 90 mm.

## 5 Sampling

The sampling shall be performed as follows:

- 5.1 For concrete sampled in the field, the test sample shall be obtained in accordance with Test Method AS 1012.1.
- 5.2 For concrete sampled in the laboratory, the test sample shall be obtained in accordance with Test Method AS 1012.2.

## 6 Procedure

The procedure shall be as follows:

- 6.1 Insert a rubber seal into the groove in the bottom of the press.
- 6.2 Centrally place screen, a new filter paper and the rubber seal into the bottom of the press.
- 6.3 Ensure the internal surface of the press cylinder is clean and free of set concrete.
- 6.4 Place the steel cylinder on the bottom of the press and lock.
- 6.5 Fill the press cylinder in two layers with fresh concrete using the scoop. Lightly rod each layer to de-aerate. Ensure the top level of the concrete in the second layer remains less than 10 mm below the top of the press cylinder.
- 6.6 Place pressure unit on top of the cylinder.
- 6.7 Place complete filter press unit into the stand, and lock in securely in place.
- 6.8 Place the beaker below the aperture at the bottom of the filter press unit.
- 6.9 Attach compressed air to the filter press unit. Using the regulator apply pressure to obtain a pressure of 500 kPa within 10 seconds. Start the timer and maintain the pressure at 500 kPa for 5 minutes and then release.
- 6.10 Determine the volume of filtered water by decanting the water in the beaker into the appropriate measuring cylinder. Record the volume of filtered water in the measuring cylinder to the nearest 1 mL ( $v$ ).
- 6.11 Remove filter press from the frame. Remove the pressure unit from the top of the test cylinder. Detach the bottom of the press.
- 6.12 Push out the concrete from the cylinder. Measure the filter cake thickness. This is the de-filtered part of the test sample and of stiff consistency, that is, still forms a cylinder (Note 9.3).

## 7 Calculations

The calculations shall be as follows:

- 7.1 Calculate the volume of press cylinder as follows:

$$V_c = \frac{\pi d^2 h}{4000}$$

where  $V_c$  = Volume of press cylinder (cm<sup>3</sup>)  
 $d$  = Diameter of press cylinder (mm)  
 $h$  = Height of press cylinder (mm)

- 7.2 Calculate the filtration loss as follows:

$$FL = \frac{1000v}{V_c}$$

where  $FL$  = filtration loss (L/m<sup>3</sup>)  
 $v$  = Volume of filter water (mL)  
 $V_c$  = Volume of press cylinder (cm<sup>3</sup>)

## 8 Reporting

The following shall be reported:

- 8.1 Volume of filter water to the nearest 1 mL.  
8.2 Filter cake thickness to the nearest 10 mm (Note 9.4).  
8.3 Filtration loss to the nearest 1 L/m<sup>3</sup> (Note 9.4).  
8.4 The number of this Test Method, that is Q479.

## 9 Notes on method

- 9.1 Further information may be obtained from Austrian Association for concrete and construction technique (12-2009) *Guideline on soft concrete*, (German: Merkblatt "Weiche Betone" by ÖVBB).  
9.2 A BAUER Concrete Filter Press has been found to be suitable.  
9.3 The test may be repeated several times after mixing of concrete to measure the stability of a mix over time.  
9.4 In terms of stability, the water retention ability is greater with a lower filtration loss and a thinner filter cake.

## Test Method Q480: Relaxation of prestressing and posttensioning material

Perform the test in accordance with AS 4672.1-2007 *Appendix B: Isothermal relaxation test*, but with the following changes, as detailed below. The purpose of these changes:

- a) addressing deficiencies in the published standard
- b) restricting testing options permitted under AS 4672.1-2007 rather than altering the procedure
- c) defining how to determine relaxation at both 1000 hours and 10,000 days.

### Sub-clause B5 (a)

In the first line, delete "60%, 70% or".

### Sub-clause B5

Replace Clause (e) with:

"Continue the test for  $330 \pm 24$  h and, without halting the test, perform an extrapolation to 1000 h and 10,000 days using Method 2 of Clause B8. The test may be finalised at this point if:

- i) the relaxation at 10 000 days is outside the range of 4.20%-5.80% inclusive, and
- ii) the regression coefficient is greater than or equal to 0.98.

If these conditions are not met, the test must continue in accordance with Clause (f)."

Add Clause (f):

"Continue the test to 1000 hours, and perform an extrapolation to 10,000 days using Method 2 of Clause B8, and using all data from 8 hours to 1000 hours. If the regression coefficient is less than 0.98, the 10,000 day relaxation value is not to be accepted. Reasons for the regression coefficient being less than 0.98 shall be investigated and reported."

Add the following to below Clause (f):

"All data points shall be recorded, and a reading that appears anomalous shall be investigated, and if valid reasons are found, such information shall be recorded on the test report."

### Sub-clause B6 (a)

Add "and 10,000 days" after "1000 h".

### Sub-clause B8

In the first sentence, replace "160" with " $330 \pm 24$ " in both instances.

Replace the third sentence with "The regression shall be performed using Method 2."

Replace the first sentence under Method 2 with:

"To extrapolate to 1000 h or 10,000 days, a regression shall be performed on the available data from 8 hours onwards using the following equation:"

### Sub-clause B9 (d)

After the first "1000 h" add "and 10,000 days" and replace "at least 160" with " $330 \pm 24$ ".

### Sub-clause B9 (f)

Replace "either Equation B7 (1) or B7 (2)" with "Equation B7 (2)".

**Sub-clause B9 (g)**

Replace with "Reference to this Standard Appendix, AS 4672.1, as modified by Q480".

## Test Method Q485: Carbonation depth of concrete

### 1 Source

This Test Method was developed in house using techniques evolved through internal departmental research investigations.

### 2 Scope

This Test Method describes a procedure for determining the depth of carbonation in concrete using phenolphthalein indicator solution. The test is usually performed on concrete core specimens.

### 3 Definitions

For this Test Method, the following definition shall apply:

- 3.1 Carbonation - refers collectively to several natural processes causing neutralisation of concrete. The most significant process occurs when carbon dioxide in the atmosphere reacts with calcium hydroxide in the cement in the presence of moisture forming calcium carbonate. This results in a reduction in pH of the concrete and an increased potential for corrosion of steel reinforcement.

### 4 Apparatus

The following apparatus is required:

- 4.1 Spray bottle or paint brush.  
4.2 Steel rule with 1 mm graduations.

The following apparatus may be used:

- 4.3 Compression testing machine and Brazil jig.

### 5 Reagents

The following reagents are required:

- 5.1 Phenolphthalein indicator solution (Note 9.1).
- Dissolve 1 g of phenolphthalein and 50 ml of ethanol in 50 ml of distilled water (use proportionally larger quantities if necessary).

### 6 Procedure

The procedure shall be as follows:

- 6.1 Obtain a specimen and determine its length to the nearest 1 mm (Note 9.2).
- 6.2 Place the specimen so that, in the case of a cylindrical specimen, it is resting on its side between the platens of the corresponding testing machine (that is, in a manner similar to that used in the Brazil or splitting test).
- 6.3 Apply a force without shock until the specimen fails diametrically. The objective is to cause a single fracture plane.
- 6.4 Remove the pieces of the specimen from the testing machine and place them to enable the reagent to be sprayed on the newly exposed surfaces of the specimen.



- 6.5 Ensure the newly exposed surfaces are dry. Paint or spray the newly exposed surfaces uniformly with the indicator solution. Areas of the newly exposed surfaces not subjected to carbonation will turn purple. Areas where carbonation of the concrete has occurred will not change colour.
- 6.6 Measure the depth of carbonation at three points to the nearest 1 mm, from the original external surface of the specimen to the border between the carbonated and un-carbonated areas (Note 9.3).

## **7 Calculations**

The calculations shall be as follows:

- 7.1 Calculate the mean of the three depths of carbonation as the depth of carbonation.

## **8 Reporting**

The following shall be reported:

- 8.1 Identification of the specimen.
- 8.2 Carbonation depth or range of depths, to the nearest 1 mm.
- 8.3 Length of the specimen to the nearest 1 mm.
- 8.4 The number of this Test Method, that is Q485.

## **9 Notes on method**

- 9.1 Before handling phenolphthalein indicator solution, the operator should consult the relevant SDS.
- 9.2 Specimens other than concrete cores may be tested.
- 9.3 It will be evident from an inspection of the specimen that one or more of the external surfaces formed part of the external surfaces of the structure from which the specimen was removed. It is from these surfaces that measurements of carbonation depth should be made. If the border between the two areas is approximately parallel to the outer surface, record the mean depth of carbonation. If the border is very uneven or diverges from the outer surface, record the range of depths observed.

## Test Method Q603: Heat stability of bitumen anti-stripping agent

### 1 Source

This Test Method was developed in-house using techniques evolved through internal departmental research investigations.

### 2 Scope

This Test Method describes the procedure for determining the stability to heat treatment of a bitumen anti-stripping agent. It assesses the loss in effectiveness of the agent due to heating through measurement of binder aggregate adhesion using Test Method Q212C – *Binder stripping value (immersion tray)*. The method is applicable to anti-stripping agents which are added directly to bituminous binders.

### 3 Apparatus

The following apparatus is required:

- 3.1 Test oven, thermostatically controlled at a temperature of  $163 \pm 1^\circ\text{C}$ .
- 3.2 Preparation oven, thermostatically controlled at a temperature of  $105 \pm 5^\circ\text{C}$ .
- 3.3 Sample containers, five metal containers of approximately 70 mm diameter and 250 mL volume, with one fitted with a tightly fitting level lid.
- 3.4 Sample lids, metal lids having a diameter of approximately 150 mm and a raised edge around the circumference (Note 8.1).
- 3.5 Water bath, maintained at a temperature of  $40 \pm 1^\circ\text{C}$ .
- 3.6 Hotplate.
- 3.7 Balance, of suitable capacity, having a resolution of at least 0.01 g and with a limit of performance within the range of  $\pm 0.05$  g.

### 4 Materials

The following materials are required:

- 4.1 Aggregate, suitable aggregate of 20 mm nominal size (Note 8.2).
- 4.2 Bitumen, Class 170 bitumen conforming to Technical Specification MRTS17 *Bitumen and Multigrade Bitumen*.
- 4.3 Cutter, bitumen cutter conforming to Technical Specification MRTS19 *Cutter Oils*.

### 5 Procedure

The procedure shall be as follows:

#### 5.1 Aggregate preparation

Wash and dry at least 150 representative pieces of the dominant size fraction of the aggregate.

## 5.2 Calibration sample preparation and testing

Prepare four calibration samples covering a range of anti-stripping agent concentrations and test as follows (Note 8.3):

- 5.2.1 Heat at least 200 g of bitumen on the hotplate until pourable.
- 5.2.2 Select one of the anti-stripping agent concentrations and calculate the mass of agent required to produce this concentration in 100 to 140 g bitumen. Weigh the calculated mass into a sample container to the nearest 0.01 g.
- 5.2.3 Weigh the mass of bitumen required to produce the anti-stripping agent concentration into the sample container to the nearest 1 g.
- 5.2.4 Gently heat the contents of the sample container on the hotplate and stir vigorously for about 5 minutes.
- 5.2.5 Calculate the mass of cutter (to the nearest 0.1 g) required to produce a 7.5 percent by volume cutback bitumen as follows:

$$M_c = \frac{7.5D_cM_B}{100D_B}$$

where  $M_c$  = mass of cutter (g)  
 $M_B$  = mass of bitumen (g)  
 $D_B$  = density of bitumen (t/m<sup>3</sup>)  
 $D_c$  = density of cutter (t/m<sup>3</sup>)

- 5.2.6 Add the mass of cutter calculated in Step 5.2.5 to the sample container with continuous stirring of the contents to achieve complete solution (Note 8.4).
- 5.2.7 Check the mass of the sample container and contents and if necessary, add additional cutter to compensate for any cutter loss. Combine repeated additions of cutter with continuous stirring until the required mass of cutter in the sample (to the nearest 0.1 g) is obtained (Note 8.5).
- 5.2.8 Pour immediately  $25.5 \pm 2.0$  g of the prepared sample from the sample container onto each of three lids. Spread the sample on each lid as quickly as possible to form a continuous and even film over the lid (Note 8.6).
- 5.2.9 Allow the three lids to cool to nearly room temperature and then immerse them to a depth of at least 25 mm in the water bath for at least 20 minutes.
- 5.2.10 Remove the lids from the water bath and then firmly press 10 pieces of aggregate into the binder of each lid. Return each lid to the water bath for a further  $10 \pm 1$  minutes and then remove.
- 5.2.11 Select one of the lids and pull (by hand) each piece of aggregate in turn from the binder and examine for binder adhesion (Note 8.7).
- 5.2.12 Visually determine the quantity of binder retained on the underside of each piece of aggregate and score it on a scale of 0 to 10, with 10 being full cover. When all 10 pieces of aggregate have been examined, add the scores and record the total as percent.
- 5.2.13 Repeat Steps 5.2.11 and 5.2.12 for the remaining two lids.
- 5.2.14 Repeat Steps 5.2.2 to 5.2.13 for the three remaining anti-stripping agent concentrations.

### 5.3 Test sample preparation and testing

Prepare the test sample containing the specified anti-stripping agent concentration and test as follows (Note 8.8):

- 5.3.1 Heat at least 200 g of bitumen on the hotplate until pourable.
- 5.3.2 Calculate the mass of agent required to produce the specified anti-stripping concentration in 100 to 140 g bitumen and weigh the calculated mass into a sample container to the nearest 0.01 g.
- 5.3.3 Weigh the mass of bitumen required to produce the anti-stripping agent concentration into the sample container to the nearest 1 g.
- 5.3.4 Gently heat the contents of the sample container on the hotplate and stir vigorously for about 5 minutes.
- 5.3.5 Allow the sample container to cool to room temperature and then fit its lid.
- 5.3.6 Place the sample container in the test oven for  $360 \pm 5$  minutes.
- 5.3.7 Remove the sample container from the test oven and allow to cool to room temperature.
- 5.3.8 Calculate the mass of cutter (to the nearest 0.1 g) required to produce a 7.5 percent by volume cutback bitumen as follows:

$$M_c = \frac{7.5D_cM_B}{100D_B}$$

- where
- |       |   |  |
|-------|---|--|
| $M_c$ | = | mass of cutter (g)                     |
| $M_B$ | = | mass of bitumen (g)                    |
| $D_B$ | = | density of bitumen (t/m <sup>3</sup> ) |
| $D_c$ | = | density of cutter (t/m <sup>3</sup> )  |

- 5.3.9 Remove the lid and gently heat the sample container on the hotplate until the contents are fluid.
- 5.3.10 Add the mass of cutter calculated in Step 5.3.8 to the sample container with continuous stirring of the contents to achieve complete solution (Note 8.4).
- 5.3.11 Check the mass of the sample container and contents and if necessary add additional cutter to compensate for any cutter loss. Combine repeated additions of cutter with continuous stirring until the required mass of cutter in the sample (to the nearest 0.1 g) is obtained (Note 8.5).
- 5.3.12 Repeat Steps 5.2.8 to 5.2.13.

## 6 Calculations

Calculations shall be as follows:

### 6.1 Stripping values

Calculate the stripping values for each set of three sample lid results as follows:

- 6.1.1 Record the total score obtained for each sample lid as the binder adhesion result.
- 6.1.2 Calculate the stripping result for each sample lid by subtraction of the binder adhesion result from 100.

- 6.1.3 If the difference between the stripping results of the three sample lids is less than 20 %, calculate the mean of the three results and record the mean as the stripping value.
- 6.1.4 If the difference between the stripping results of the three sample lids exceeds 20 % but two of the results agree to within 10 %, calculate the mean of these two results and record this mean as the stripping value.
- 6.1.5 If the difference between the stripping results of the three sample lids exceeds 20 % and no two results agree within 10 %, repeat the test.

## 6.2 Calibration samples

Plot the stripping values obtained for the four calibration samples against the respective anti-stripping agent concentrations and apply the best fit curve.

## 6.3 Test sample

- 6.3.1 Using the calibration curve obtained in Step 6.2, determine the effective anti-stripping agent concentration corresponding to the stripping value obtained for the test sample.
- 6.3.2 Calculate the heat stability of the test sample as follows:

$$S = \frac{100C_2}{C_1}$$

- where
- $S$  = heat stability (%)
  - $C_1$  = specified anti-stripping agent concentration (%)
  - $C_2$  = effective anti-stripping agent concentration (%) determined in Step 6.3.1.

## 7 Reporting

The following shall be reported:

- 7.1 Heat stability of the sample to the nearest 1%, and
- 7.2 The number of this Test Method, that is Q603.

## 8 Notes on method

- 8.1 Press-on lids from 4 litre capacity tins have been found suitable.
- 8.2 A suitable aggregate is one which provides a wide range of bitumen stripping values over the selected range of anti-stripping agent concentration.
- 8.3 The anti-stripping agent concentrations selected for the calibration samples should include 0% and that specified for the test sample. The remaining two concentrations should be selected between these two extremes at equidistant intervals.
- 8.4 If the contents have cooled so that thorough mixing is difficult, gentle warming of the contents is permitted.
- 8.5 It is important to reasonably ensure that the correct quantity of cutter is added to the binder. Varying quantities of cutter will lead to varying binder viscosities which have considerable influence on the stripping value obtained.
- 8.6 If the sample on the lid has cooled so that spreading of the sample to form a continuous film over the lid is difficult, minimal warming of the lid in the oven is permitted. However, under no circumstances shall a hotplate be used for this purpose.

- 8.7 Extract pieces of aggregate evenly with a direct upward pull without any twisting or shoving motion. Where only collar or edge adhesion has taken place, exercise care so that the ductile binder retained at the edge of the aggregate does not contact or overlay the underside of the aggregate before an assessment of stripping.
- 8.8 The specified anti-stripping agent concentration will normally be that concentration recommended for field use. However, where the heat stability of a number of anti-stripping agents is to be compared, the one specified concentration should be adopted for all such agents.

## Test Method Q604: Pourability of a liquid bitumen anti-stripping agent

### 1 Source

This Test Method was developed in-house using techniques evolved through internal departmental research investigations.

### 2 Scope

This Test Method describes the procedure for determining the pourability of a liquid bitumen anti-stripping agent. It may be used to indicate how readily a liquid bitumen anti-stripping agent will pour from a supply container at low temperature.

### 3 Apparatus

The following apparatus is required:

- 3.1 Measuring cylinders, three unstoppered measuring cylinders of 25 mL capacity, graduated in 0.5 mL increments and conforming to ISO 4788.
- 3.2 Receivers, two crow receivers of 100 mL capacity conforming to BS 658.
- 3.3 Water bath, maintained at a temperature of  $5 \pm 0.5^\circ\text{C}$ .
- 3.4 Thermometer, a partial immersion liquid in glass thermometer or other suitable temperature measuring device, with a range of at least  $0\text{-}10^\circ\text{C}$ , graduated in subdivisions of  $0.5^\circ\text{C}$  or less, with an uncertainty of no more than  $0.2^\circ\text{C}$  (for example, ASTM 90C).
- 3.5 Retort stand, boss head and clamp.
- 3.6 Travelling side arm stop (as illustrated in Figure 1 and detailed in Figure 2).
- 3.7  $45^\circ$  set-square or protractor.
- 3.8 Digital stopwatch.
- 3.9 Steel rule, of at least 300 mm length and accurate and readable to 1 mm.
- 3.10 Pipette, a pipette of 10 ml capacity.
- 3.11 Stirring rods, 2 glass stirring rods.

### 4 Procedure

The procedure shall be as follows:

- 4.1 Thoroughly mix the sample and add approximately 30 mL to each of two 25 mL measuring cylinders (that is, approximately 5 mL above the 25 mL mark).
- 4.2 Place the cylinders containing the samples into the water bath.
- 4.3 Stir the samples regularly with the stirring rods until they attain a temperature of  $5 \pm 0.5^\circ\text{C}$ .
- 4.4 Assemble the clamp, travelling side arm stop, boss head, retort stand and remaining 25 mL measuring cylinder on a level bench as illustrated in Figure 1.
- 4.5 Adjust the cylinder location within the clamp so that the clamp is positioned near the base of the cylinder.
- 4.6 Loosen the grub screw and set the side of the measuring cylinder at  $45^\circ$  to the horizontal using the set-square or protractor. Retighten the grub screw.

- 4.7 Check the angle to ensure that the measuring cylinder is at 45° to the horizontal when stopped by the travelling side arm stop. The cylinder is now in the pour position.
- 4.8 Return the cylinder to the vertical position and then adjust the cylinder within the clamp so that the 20 mL mark on the cylinder is level with the upper edge of the clamp.
- 4.9 Return the cylinder to the pour position. Adjust the boss head, travelling sidearm stop and clamp so that the lower edge of the cylinder mouth is  $255 \pm 5$  mm above the bench. This is the height at which the apparatus is to be set during testing.
- 4.10 Position a 100 mL crow receiver on the bench in a suitable location to receive sample draining from the measuring cylinder.
- 4.11 Return the cylinder to the vertical position and remove the cylinder.
- 4.12 Remove any excess liquid above the 25 mL mark on each measuring cylinder in the water bath using the pipette.
- 4.13 Remove one of the measuring cylinders from the bath, quickly dry and clamp into position so that the 20 mL mark on the cylinder is level with the upper edge of the clamp.
- 4.14 Rapidly move the cylinder to the pour position and immediately start the stopwatch.
- 4.15 At the 5 second time increment, rapidly return the measuring cylinder to the vertical position, and then remove it from the clamp.
- 4.16 Record the volume of sample in the receiver ( $V_1$ ) to the nearest 1 mL.
- 4.17 Position the second 100 mL crow receiver on the bench in a suitable location to receive sample draining from the measuring cylinder.
- 4.18 Repeat Steps 4.13 to 4.15 for the remaining measuring cylinder.
- 4.19 Record the volume of sample in the receiver ( $V_2$ ) to the nearest 1 mL.
- 4.20 If the difference between  $V_1$  and  $V_2$  exceeds 4 mL, repeat the test.

## 5 Calculations

Calculations shall be as follows:

- 5.1 Calculate the pourability of the sample as follows:

$$P = 2(V_1 + V_2)$$

where  $P$  = pourability (%)  
 $V_1$  = volume of sample drained in the first receiver (mL)  
 $V_2$  = volume of sample drained in the second receiver (mL)

## 6 Reporting

The following shall be reported:

- 6.1 Pourability of the sample to the nearest 1%, and
- 6.2 The number of this Test Method, that is Q604.



Figure 1 - Pourability apparatus configuration

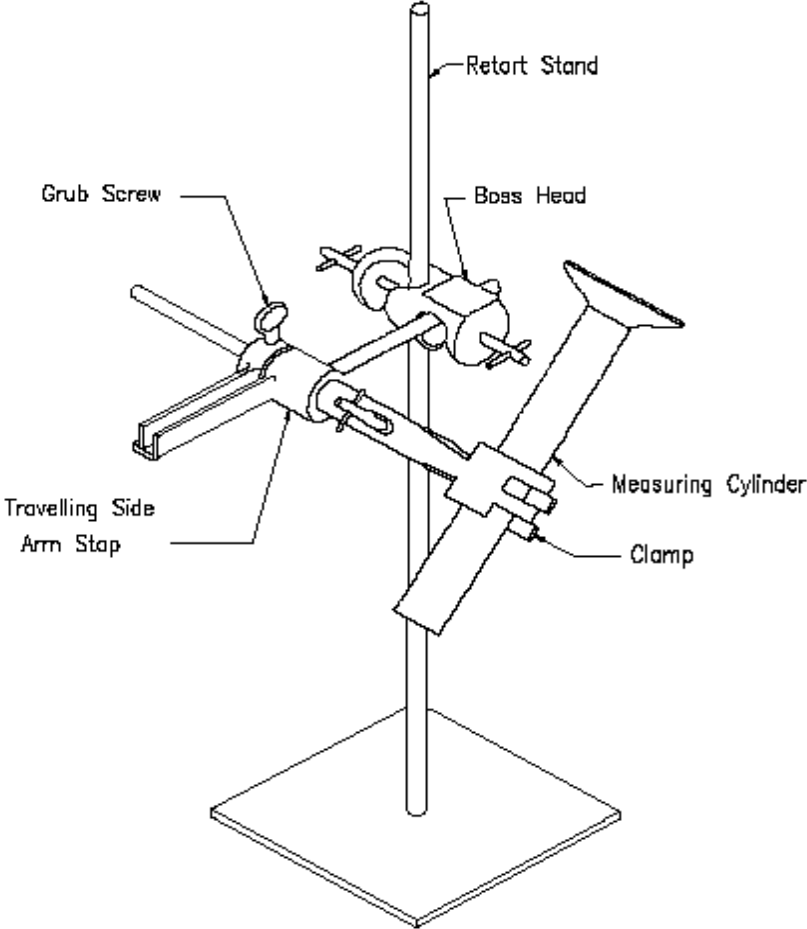
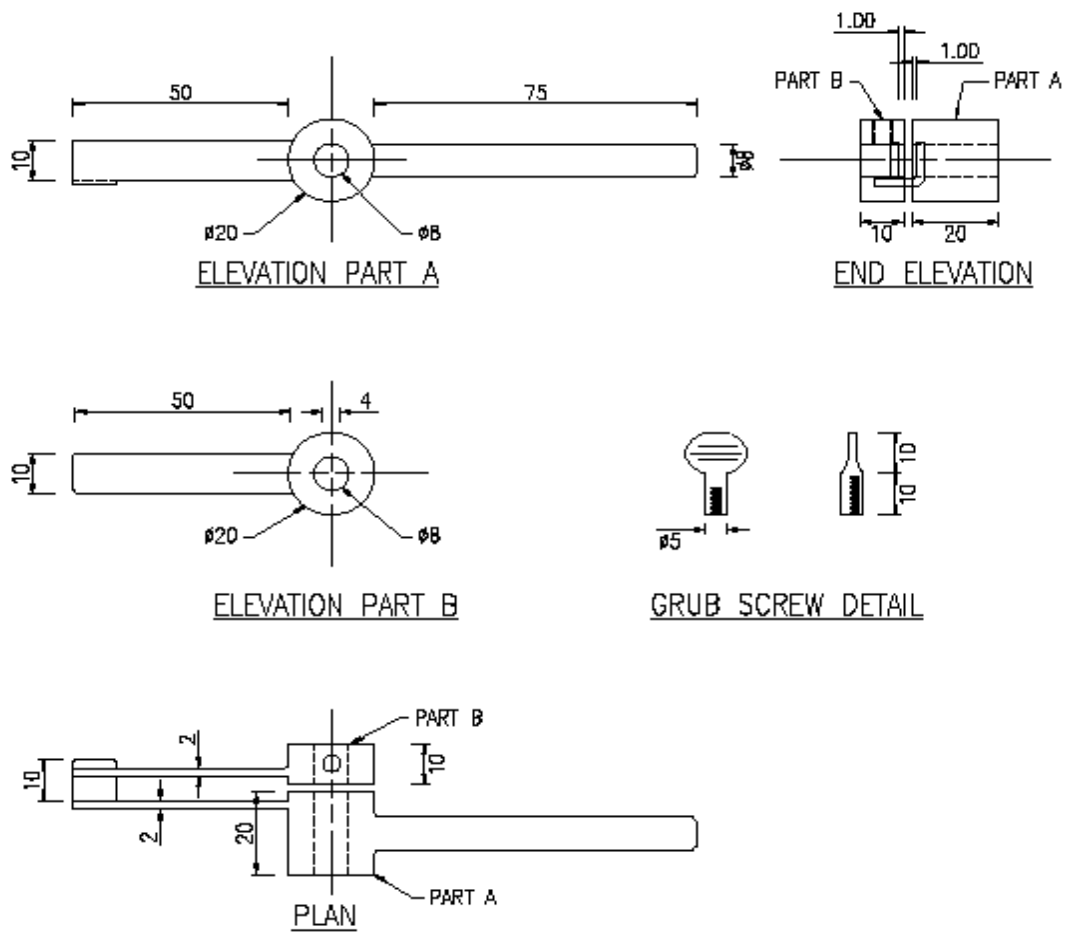

Figure 2 - Travelling side arm stop



## Test Method Q704: Skid resistance – portable pendulum

### 1 Source

This Test Method applies the principles of AS 4663: *Slip resistance measurement of existing pedestrian surfaces – Appendix A: Wet pendulum Test Method*. It differs from this standard by:

- a) performing testing of road surfaces
- b) using the 75 mm wide TRL slider for all testing
- c) only requires one test at a location
- d) using the wet surface temperature for temperature correction, and
- e) correcting the skid resistance value to the Transport and Main Roads-adopted reference surface temperature for skid resistance measurement of 30°C.

### 2 Scope

This Test Method describes the procedure for the determination of the resistance of a road surface to skidding. The apparatus measures the frictional resistance between a rubber slider mounted on the end of a pendulum arm and the road surface.

### 3 Apparatus

Where appropriate, the working tolerances of apparatus are contained in Tables 1, 2 and 3. Examples of the apparatus are shown in AS 4663 Figures A1, A2 and A3.

The following apparatus is required:

- 3.1 Pendulum friction tester, comprising a tester and scale conforming to EN 16165: *Determination of slip resistance of pedestrian surfaces – Methods of evaluation*. All bearings and working parts of the instrument are enclosed as far as possible and all materials used suitably treated to prevent corrosion under wet conditions. Use and store the pendulum friction tester in a dust-free environment that is not subject to a large temperature variation. Calibrate the tester to ensure conformance to the following requirements at intervals not exceeding two years. The tester will consist of the following:
  - a) Spring-loaded rubber slider of the mass, size and shape specified in Clause 3.2, mounted on the end of a pendulum so that the sliding edge is 515 mm from the axis of suspension.
  - b) The mass of the pendulum including the slider is 1.50 kg with the centre of gravity lying on the axis of the pendulum at 410 mm from the centre of suspension. Mount the slider on an axis set at an angle of 25 degrees to the horizontal when the pendulum is at the lowest point of its swing, so that only the rear edge of the slider contacts the test surface. The slider can turn about its axis without obstruction to follow unevenness of the surface. Spring load the slider against the test surface. The calibration procedure will set the nominal static force on the slider.
  - c) Means for levelling the instrument.
  - d) Means for raising and lowering the axis of suspension of the pendulum so that the slider can:
    - i. swing clear of the surface of the specimen, and
    - ii. be set to slide over a fixed length of the surface.

- e) Means for holding and releasing the pendulum so that it falls freely from a horizontal position.
- f) Pointer balanced about the axis of suspension, indicating the position of the pendulum throughout its forward swing and moving over the circular scale attached to the instrument. The mass of the pointer, excluding felt friction washers, is not more than 85 g. The friction in the pointer mechanism is adjustable so that, with the pendulum swinging freely from a horizontal position, will bring the outward tip of the pointer to rest on the forward swing of the pendulum at a point 10 mm below the horizontal, the point corresponding to the zero position on the attached circular scale, and
- g) A device for rigidly locating the abrasive paper and lapping film such that
  - i. the abrasive paper or lapping film is bisected by trailing edge of the rubber slider when the pendulum hangs freely at rest, and
  - ii. the full width of the slider will remain in contact with the abrasive paper or lapping film over a length of  $124 \pm 1$  mm.

### 3.2 Rubber sliders:

- a) Rubber sliders used in the pendulum friction tester are 76.0 mm long, 25.4 mm wide and 6.4 mm thick. The sliding edge will be square, clean cut and free from contamination. The rubber slider is rigidly backed and, together with the rigid backing plate having a total mass of 35 g.
- b) Slider material is Transport Research Laboratory (TRL) rubber (IRHD 55), conforming to dimensions in Table 2 and the resilience requirements of Table 3. Avoid handling of the surface of a rubber slider and, when not in use, store sliders in the dark at a temperature between 10°C and 25°C. Discard a slider when:
  - i. more than 12 months old from the date stamped on the slider
  - ii. it does not conform to the requirements of Table 2, or
  - iii. the chamfers worn on the two trailing edges of the slider are more than 4 mm wide, the chamfer measurement being made on the most representative portion of the trailing edge.

3.3 Measuring gauge, marked with the surface contact length of 125 mm to 127 mm. This may be supplied with the friction tester.

3.4 Bannister brush.

3.5 Spray bottle and water container.

3.6 Temperature measuring device, suitable for measuring surface temperature, with range appropriate for the expected surface temperatures, with a resolution of 1°C or less and an uncertainty of no more than 0.5°C. A thermometer with a surface probe or an infra-red thermometer have been found to be suitable for surface temperatures.

3.7 Temperature measuring device, suitable for measuring ambient temperature, with range appropriate for the expected ambient temperature, with a resolution of 1°C or less and an uncertainty of no more than 0.5°C. A thermometer with a thermocouple probe would be suitable for ambient temperatures.

## **4 Materials**

The following materials are required:

- 4.1 Potable water.
- 4.2 Suitable insulation material for temperature measurements (for example, polystyrene block or fine sand).
- 4.3 Abrasive paper, wet and dry abrasive paper, Grade P400, mounted on a flat rigid surface.
- 4.4 Lapping film, sheet of 3M 261X lapping film Grade 3MIC, mounted on a flat rigid surface.
- 4.5 Lint free cloth.

## **5 Preparation**

The following preparation is required:

### **5.1 Adjusting the friction tester equipment**

- 5.1.1 Bring the pendulum apparatus, abrasive paper, lapping film and the water spray bottle and container onto the test area at least 10 minutes before testing.
- 5.1.2 Mount the friction tester on its base and adjust the levelling screws so that the levelling bubble is centred, and the tester is appropriately aligned with the test surface.
- 5.1.3 Install the first rubber slider on the friction tester, ensuring the correct positioning of the two washers and spring.
- 5.1.4 Raise the axis of the suspension of the pendulum so that it swings freely. Adjust the friction rings in the pointer mechanism so that, when the pendulum and pointer are released from the right-hand horizontal position, the pointer will zero repeatedly.

### **5.2 Conditioning rubber sliders**

Sliders are dry and wet conditioned before use and may be reused, provided they are dry and wet conditioned conforming to the requirements in Steps 5.2.2 g) and 5.2.3 i) (Note 9.1). New sliders are dry conditioned before use in accordance with Step 5.2.2 by swinging the slider 10 times across the surface of the abrasive paper. Condition the rubber slider before use on test location as follows:

- 5.2.1 Install the rubber slider on the friction tester, ensuring the correct positioning of the two washers and spring.
- 5.2.2 Perform dry conditioning of the rubber slider as follows:
  - a) Raise the axis of the suspension of the pendulum so that it swings freely. Adjust the friction rings in the pointer mechanism so that, when the pendulum and pointer are released from the right-hand horizontal position, the pointer will zero repeatedly.
  - b) Secure a piece of abrasive paper beneath the slider.
  - c) Check that the trailing edge of the slider is parallel to the minor axis of the abrasive paper when the pendulum hangs freely at the bottom of its swing.
  - d) Adjust the height of the axis of suspension of the pendulum so that the entire trailing edge of the slider is in contact with the abrasive paper while traversing the surface. The trailing edge of the slider is to be in contact with the abrasive paper over a length of 125 mm to 127 mm while traversing the surface.
  - e) Return the pendulum to its horizontal position and move the pointer against its stop.

- f) Release the pendulum from its horizontal position and allow the pendulum and pointer to swing over the specimen. To avoid damage to the slider, catch the pendulum on its return swing, lift the slider and return the pendulum to the horizontal position.
- g) Perform Step 5.2.2 f) a further two times, so that the rubber has a consistently chamfered edge. Record the readings from the last two swings. These readings should be in the range of  $115 \pm 10$  and should not differ by more than 2.
- h) Brush the surface of the abrasive paper with a soft, clean brush to remove any rubber particles.

5.2.3 Perform wet conditioning of the rubber slider as follows:

- a) Raise the axis of the suspension of the pendulum so that it swings freely. Adjust the friction rings in the pointer mechanism so that, when the pendulum and pointer are released from the right-hand horizontal position, the pointer will zero repeatedly.
- b) Secure a piece of lapping film beneath the slider.
- c) Check that the trailing edge of the slider is parallel to the minor axis of the lapping film when the pendulum hangs freely at the bottom of its swing.
- d) Adjust the height of the axis of suspension of the pendulum so that the entire trailing edge of the slider is in contact with the lapping film while traversing the surface. The trailing edge of the slider is to be in contact with the lapping film over a length of 125 mm to 127 mm while traversing the surface.
- e) Return the pendulum to its horizontal position and move the pointer against its stop.
- f) Wet the surface of the lapping film using the water spray bottle.
- g) Release the pendulum from its horizontal position and allow the pendulum and pointer to swing over the lapping film. To avoid damage to the slider, catch the pendulum on its return swing, lift the slider and return the pendulum to the horizontal position.
- h) Repeat Steps 5.2.3 f) to 5.2.3 g) until the slider has moved 10 times across the wet lapping film.
- i) Record the readings from the last five swings. These readings should be in the range of  $55 \pm 6$ .

### 5.3 Environmental conditions

Record the environmental conditions at the test location, for example, ambient temperature, weather conditions, condition of the surface, presence of any contaminants or surface treatments.

### 5.4 Test conditions

- 5.4.1 Testing to evaluate the friction characteristics is to be performed on a flat surface where possible.
- 5.4.2 Testing will be performed in the wheel-paths with the pendulum swinging in the direction of vehicle travel ( $0^\circ$ ) unless otherwise specified (refer to Figure 1).

## 6 Procedure

The procedure shall be as follows:

- 6.1 If required, determine the surface texture depth in accordance with Test Method ATM 250.

- 6.2 At each location, prepare for testing in accordance with Section 5.
- 6.3 Ensure there is no movement of the apparatus during testing. It may be necessary to protect the apparatus from winds or movement of air caused by traffic; for example, bags of steel shot, sand or other suitable material may be placed across the rear foot stay. High friction pads may also be placed under the pendulum feet. In both cases, the pendulum must remain level.
- 6.4 Clear the road surface of loose materials by brushing briskly with a brush.
- 6.5 Examine the surface of the rubber slider and if there is contamination, clean the surface with a wet, lint-free cloth.
- 6.6 Raise the axis of suspension of the pendulum so that the arm swings freely. Adjust the friction rings in the pointer mechanism so that, when the pendulum arm and pointer are released from the right-hand horizontal position, the pointer will zero repeatedly (Note 9.2).
- 6.7 Adjust the height of the axis of suspension of the pendulum by means of the rack and pinion so that the whole trailing edge of the slider is in contact with the test surface for the set length while traversing the test surface. This length is set by aligning the trailing edge of the slider against the marks on the measuring gauge. When the apparatus has been set correctly, the sliding length should be between 125 and 127 mm on the scale.
- 6.8 Using the spray bottle, thoroughly wet the rubber slider and test surface with water. Free water should be visible on the test surface.
- 6.9 Return the pendulum to its horizontal position and move the pointer against its stop. Release the pendulum and pointer from the horizontal position, allowing it to swing over the test surface. As the pendulum and slider falls back from its peak after traversing the test surface, catch it before the slider again makes contact and note the reading indicated by the pointer (Note 9.3).
- 6.10 Lift the slider using the lifting lever, keeping it clear of the road surface and return the pendulum and pointer to the horizontal position and lock in the release position. Record the wet skid resistance value to the nearest one BPN.
- 6.11 Repeat Steps 6.7 to 6.10 four times, rewetting the test surface before each swing. Record the mean of the five readings, provided they do not differ by more than three BPN as the mean wet skid resistance value ( $SRV_t$ ). If the range of the five readings exceeds three BPN, repeat Steps 6.7 to 6.10 until three successive readings are the same and record this value as the mean wet skid resistance value ( $SRV_t$ ).
- 6.12 Raise the head of the pendulum so that the pendulum arm swings clear of the surface and check the free swing for zero error. If the free swing does not zero, then adjust the pendulum in accordance with Step 6.6 and repeat the testing at the location in accordance with Steps 6.7 to 6.11. If the check of the free swing for zero error fails again, remove the pendulum from service and partially or fully recalibrate the pendulum.
- 6.13 Place the temperature measurement device on the wet road surface at the test location.
- 6.14 Record as the test surface temperature to the nearest 1°C ( $t$ ).
- 6.15 Record the ambient temperature to the nearest 1°C.

## 7 Calculations

Calculations shall be as follows:

- 7.1 Calculate the mean wet skid resistance value at 30°C as follows:

$$SRV_{30} = \frac{SRV_t}{1 - 0.00525(t - 30)}$$

where  $SRV_{30}$  = mean wet skid resistance value corrected to 30°C (BPN) (Oliver 1980)

$SRV_t$  = mean skid resistance value at the test surface temperature

$t$  = test surface temperature (°C)

## 8 Reporting

The following shall be reported:

- 8.1 Identification of the test location.
- 8.2 A description of the test location including details of the surface tested, the environmental conditions and direction of test.
- 8.3 Date of test.
- 8.4 Ambient temperature to the nearest 1°C.
- 8.5 Test surface temperature to the nearest 1°C.
- 8.6 The mean wet skid resistance value ( $SRV_{30}$ ) corrected to 30°C to the nearest one BPN (Note 9.4).
- 8.7 The surface texture depth in accordance with Test Method ATM 250, if required.
- 8.8 The number of this Test Method, that is Q704.

## 9 Notes on method

- 9.1 Each slider is reversible and has two edges which can be conditioned for use. Both edges may be used but not for the same test location.
- 9.2 Adjustment of the friction rings is necessary as the testing is carried out under varying conditions of temperature and wind velocity.
- 9.3 If the slider strikes the test surface on the return swing, it can be damaged and affect the zero adjustment.
- 9.4 The skid resistance of a dry surface may also be measured using the same method except that water is not applied to either the rubber slider or road surface. However, the appropriate correction for temperature is not known.

## 10 References

- 10.1 Oliver JWH (September 1980) *Temperature correction of skid resistance values obtained with the British portable skid resistance tester*, Internal report AIR 314-2, Australian Road Research Board.



**Table 1 – Dimensions and tolerances for pendulum friction tester**

Apparatus	Dimension	Tolerance
<b>Pendulum friction tester</b>		
Distance of sliding edge from axis of suspension (mm)	515	± 2
Mass of slider and pendulum (kg)	1.50	± 0.03
Distance from centre of gravity of pendulum to the centre of suspension (mm)	410	± 5
Angle of slider to horizontal at lowest point of swing (°)	25	± 1
Mass of pointer (g)	85	maximum

**Table 2 – Dimensions and tolerances for rubber sliders**

Apparatus	Dimension	Tolerance
<b>Rubber slider</b>		
Length of rubber slider (mm)	76.0	± 1.0
Width of rubber slider (mm)	25.4	± 1.0
Thickness of rubber slider (mm)	6.4	± 0.5
Mass of rubber slider and backing plate (g)	35	± 2

**Table 3 – Properties of rubber slider**

Property	Temperature (°C)				
	0	10	20	30	40
Resilience (%)*	44 to 49	58 to 65	66 to 73	71 to 77	74 to 79
Hardness (IRHD)+	55 ± 5	55 ± 5	55 ± 5	55 ± 5	55 ± 5

\* Lupke rebound test in accordance with BS ISO 4662.

+ Hardness in accordance with BS ISO 48.

**Figure 1 – Direction of test**

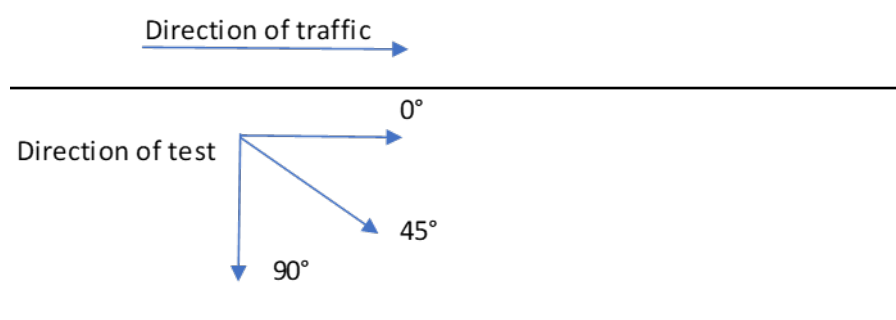

## Test Method Q707A: Permeability of road surfacing and granular materials – even flow field permeameter

### 1 Source

This Test Method was developed in-house using techniques evolved through internal departmental research investigations in Waters TJ (2001) *Permeability of Road Surfacing and Granular Materials (Evenflow Field Permeameter)*, Report TT363, Materials Branch, Department of Main Roads.

### 2 Scope

This Test Method describes the procedure for the determination of the permeability of pavement materials using the Evenflow Field Permeameter. It is applicable to bituminous materials (for example sprayed seal, asphalt) and granular materials (where the surface is reasonably flat and well compacted) having permeability values within the range 0.04 to 1500 $\mu$  m/s. The guidelines included for categorising permeability values were developed specifically for asphalt, although they do have application to other materials.

### 3 Apparatus

The following apparatus is required:

- 3.1 Field permeameter, consisting of an inverted clear plastic conical funnel attached to a rigid plastic base plate as follows (Figure 1):
  - a) Base plate (Figure 2) with a diameter of about 200 mm and a thickness of about 20 mm. Containing a centrally located circular hole of diameter 100  $\pm$  1 mm. Form a circular groove around the hole in the top surface of the base plate to locate the top edge of the inverted funnel centrally over the hole. The top surface of the base plate extending beyond the bottom surface by about 10 mm to enhance removal of the base plate from the pavement at the completion of the test.
  - b) Funnel will have a top internal diameter of about 150 mm and a height of about 230 mm. The stem of the funnel having an external diameter of about 14 mm and an internal diameter of about 12 mm, and
  - c) With the inverted funnel inserted into the groove on the base plate, apply silicone sealant externally over the join between the funnel and the base plate to secure the funnel. Mark the funnel at heights of 100 mm, 150 mm and 200 mm above the bottom of the base plate.
- 3.2 Small funnel, with a top internal diameter of about 65 mm and a ribbed stem to provide an air gap when fitted into the permeameter funnel. Reduce the length of the stem as required so that, when positioned in the permeameter funnel, the bottom of its stem is approximately 10 mm above the 200 mm mark on the stem of the permeameter funnel.
- 3.3 Annular template, of diameter 190 mm and containing a centrally located hole of 110 mm diameter (bituminous materials only).
- 3.4 Annular restraining weight, of mass about 4 kg and of suitable dimensions to allow positioning over the permeameter funnel to rest on the base plate.
- 3.5 Stop watch or other suitable timing device readable to 0.1 s.
- 3.6 Measuring cylinder, plastic measuring cylinder of 100 mL capacity.
- 3.7 Beakers, plastic beakers of appropriate capacity (for example, 100 mL, 600 mL and 1000 mL).

- 3.8 Water container, having a capacity of at least 10 litres.
- 3.9 Spatula, to aid application of the silicone sealant to the pavement or base of the permeameter.
- 3.10 Marking crayon.
- 3.11 Assorted implements, for cleaning of the pavement before and after testing (for example wire brush, broom, paint scraper).

#### **4 Materials**

The following materials are required:

- 4.1 Silicone sealant, neutral cure (Note 8.1).
- 4.2 Potable water.

#### **5 Procedure**

The procedure shall be as follows:

- 5.1 Remove any loose material from the pavement.
- 5.2 Attach the permeameter to the pavement using the appropriate method as follows:
  - 5.2.1 Granular Material (Note 8.2)
    - a) Apply silicone sealant to the base of the permeameter to a thickness of about 2 mm.
    - b) Press the permeameter firmly onto the pavement.
  - 5.2.2 Sprayed Seal / Asphalt Material
    - a) Place the annular template on the pavement and use the crayon to mark two concentric circles of diameter 100 mm and 200 mm (Note 8.3).
    - b) Apply silicone sealant to the pavement between the two concentric circles and spread it out evenly to a final thickness of about 2 mm using a spatula (Note 8.4).
    - c) Align the base plate with the 200 mm diameter circle and press the permeameter firmly onto the pavement.
- 5.3 Position the restraining weight onto the base plate.
- 5.4 Place the small funnel into the stem of the permeameter funnel.
- 5.5 Using a beaker of appropriate capacity, pour water into the small funnel to fill the permeameter funnel to the 100 mm mark.
- 5.6 Check for leaks at the base of the permeameter. If any leakage is observed, caulk the area with additional silicone sealant (Note 8.5).
- 5.7 Continue adding water to the permeameter to maintain the water level above the 100 mm mark for 5 minutes or until 600 mL of water has passed through the pavement.
- 5.8 Immediately add additional water as required to raise the water level to just above the 200 mm mark. Discontinue the addition of water and record the time taken for the water level to drop from the 200 mm mark to the 150 mm mark to the nearest 0.1 seconds.

5.9 If the time recorded in Step 5.8 exceeds 2 seconds, use the falling head method. Otherwise, use the constant head method. The relevant method will be as follows:

5.9.1 Falling head method

Repeat Step 5.8 twice.

5.9.2 Constant head method

a) Allow the water level in the permeameter funnel to fall to the 100 mm mark, start the timer and then progressively pour 100 mL of water from the measuring cylinder into the funnel at a rate that maintains the water level in the permeameter funnel at the 100 mm mark.

b) Record the time in seconds to transfer 100 mL of water to the permeameter funnel to the nearest 0.1 seconds.

c) Add additional water as required to raise the water level in the permeameter above the 100 mL mark.

d) Repeat Steps 5.9.2 a) to c).

e) Repeat Steps 5.9.2 a) to b).

5.10 Remove the silicone sealant from the base of the permeameter and the bulk of the silicone sealant from the pavement.

## 6 Calculations

Calculations shall be as follows:

### 6.1 Falling head method

6.1.1 Calculate the mean of the three time measurements ( $t$ ).

6.1.2 Calculate the volume of the stem of the permeameter funnel between the 150 mm and 200 mm marks as follows (Note 8.6):

$$V = \frac{\pi D^2}{80}$$

where  $V$  = volume of stem between 150 mm and 200 mm marks (mL)

$D$  = internal diameter of stem at 175 mm mark (mm)

6.1.3 Calculate the permeability as follows:

$$k = \frac{25.5V}{t}$$

where  $k$  = permeability ( $\mu\text{m/s}$ )

$V$  = volume of stem between 150 mm and 200 mm marks (mL)

$t$  = mean time (s)

6.2 Constant head method

6.2.1 Calculate the mean of the three time measurements ( $t$ ).

6.2.2 Calculate the permeability as follows:

$$k = \frac{3819}{t}$$

where  $k$  = permeability ( $\mu\text{m/s}$ )

$t$  = mean time (s)

## 7 Reporting

The following shall be reported:

- 7.1 Test location including a longitudinal (chainage) and a lateral (offset) reference.
- 7.2 Test site description including pavement type and surface condition.
- 7.3 Permeability to three significant figures ( $\mu\text{m/s}$ ).
- 7.4 Permeability category and description (Table 1), and
- 7.5 The number of this Test Method, that is Q707A.

## 8 Notes on method

- 8.1 Before handling the silicone sealant, the operator should consult the relevant SDS.
- 8.2 For granular materials, trial runs may be necessary to ensure that there is sufficient silicone sealant to effectively seal the permeameter without contaminating the exposed surface with an excess of sealant. It is desirable to keep the diameter of the exposed surface as close as possible to 100 mm.
- 8.3 The dimensions of the annular template allow for a 5 mm gap between the line marked by the crayon and the edge of the template. If necessary, the marking technique should be adjusted to ensure that the internal diameter of the smaller circle is 100 mm.
- 8.4 The sealant should be applied in a manner which spreads the sealant to, but not inside, the 100 mm diameter circle when the permeameter is pressed into position on the pavement.
- 8.5 It is normal for water to escape through the pavement surface at the outside edge of the base plate and this does not constitute leakage.
- 8.6 Alternatively, the stem end of the permeameter funnel can be stoppered, the permeameter inverted and water added to the 200 mm mark. The volume of water between the 200 mm and 150 mm marks can then be measured directly to the nearest 0.1 mL using a burette.

**Table 1 – Permeability category and description**

Permeability ( $\mu\text{m/s}$ )	Category	Description
0.01 - 0.10	A1	Very low permeability
0.11 - 1.00	A2	Low permeability
1.01 – 10.0	B	Moderately permeable
10.1 - 100	C	Permeable
101 - 1000	D	Moderately free draining
1001 - 10000	E	Free draining

Figure 1 – Evenflow field permeameter

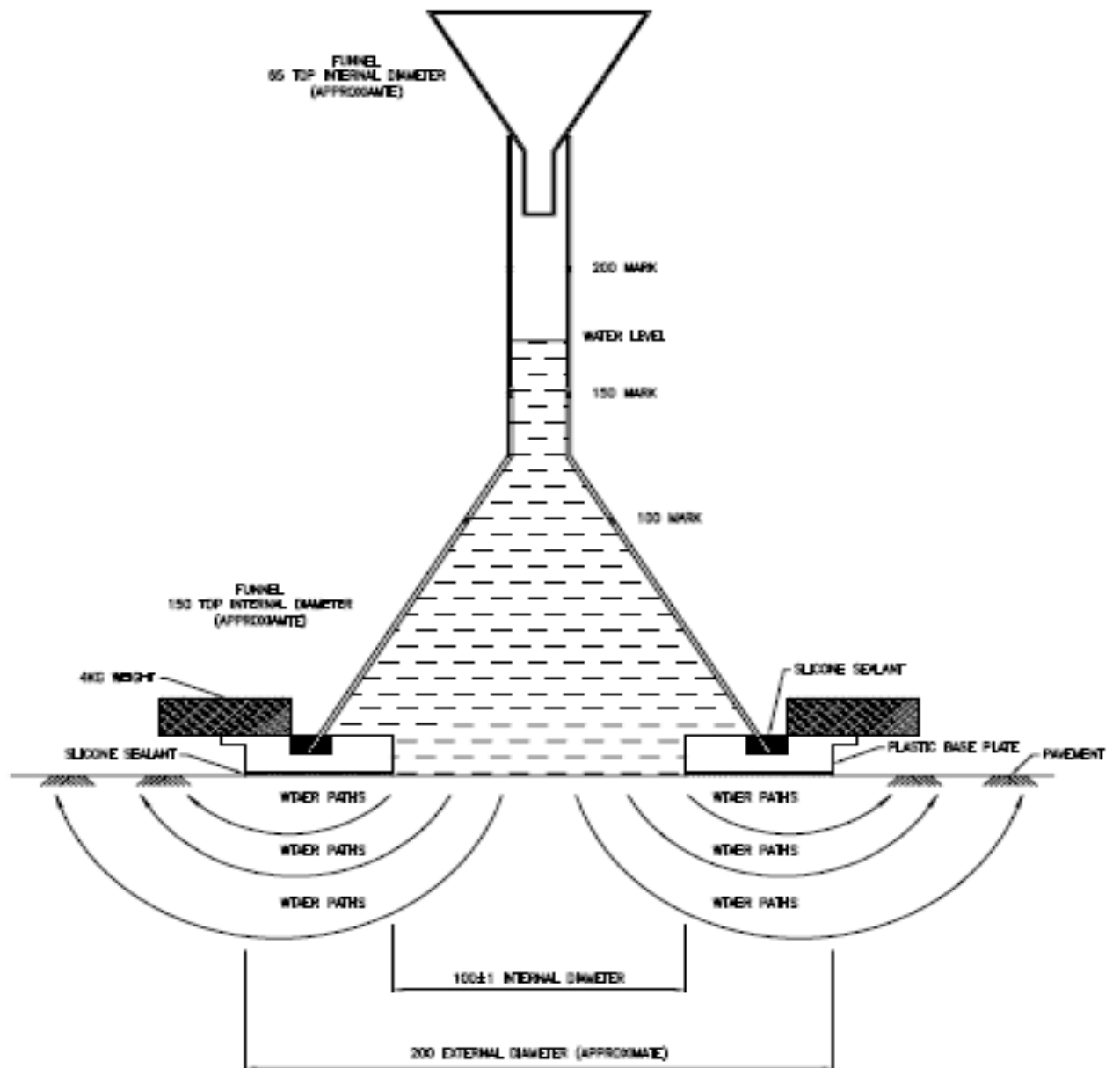
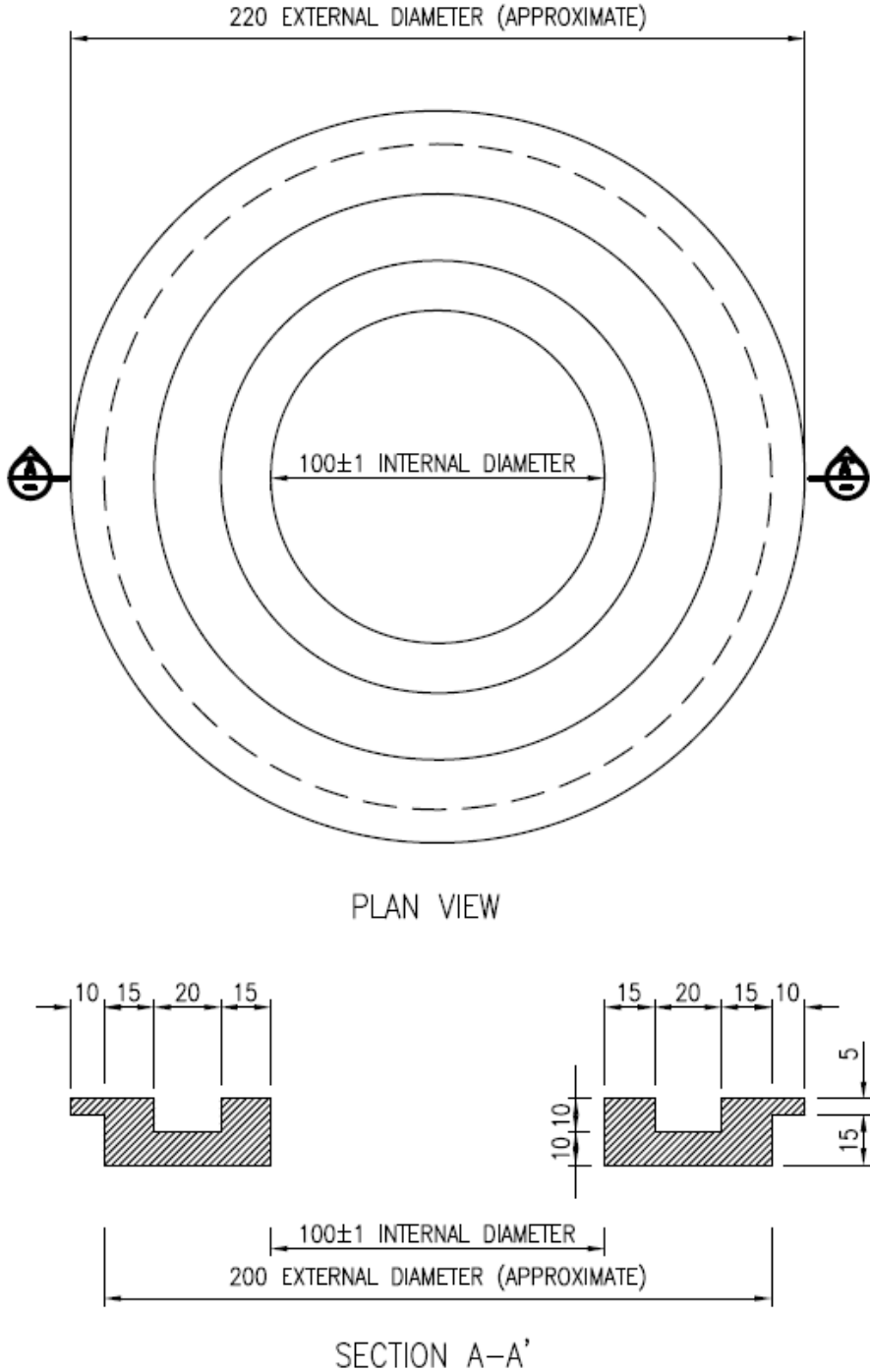

Figure 2 – Plastic base plate



## Test Method Q707B: Permeability of road surfacing and granular materials – rapid flow field permeameter

### 1 Source

This Test Method was developed in-house using techniques evolved through internal departmental research investigations Waters, TJ (1999) *Permeability of Road Surface Materials Using the Rapidflow Field Permeameter*”, Report TT305, Materials Branch, Department of Main Roads.

### 2 Scope

This Test Method describes the procedure for the determination of the permeability of pavement materials using the Rapid Flow Field Permeameter. It is applicable to bituminous materials (for example sprayed seal, asphalt) and granular materials (where the surface is reasonably flat and well compacted) having permeability values within the range 10 to 5000 mm/s.

### 3 Apparatus

The following apparatus is required:

- 3.1 Field permeameter (Figure 1, consisting of a cylinder of clear rigid plastic (for example Perspex) attached to a rigid plastic base plate as follows:
  - a) Base plate (Figure 2) with a diameter of about 200 mm and a thickness of about 20 mm. Containing a centrally located circular hole of diameter  $100 \pm 1$  mm. Form a circular groove around the hole in the top surface of the base plate to locate the top edge of the inverted funnel centrally over the hole. The top surface of the base plate extending beyond the bottom surface by about 10 mm to enhance removal of the base plate from the pavement at the completion of the test.
  - b) Cylinder with a height of about 215 mm, an internal diameter of about 145 mm and an outside diameter of about 152 mm, and
  - c) With the bottom of the cylinder inserted in the groove on the base plate, apply silicone sealant externally over the joint between the cylinder and the base plate. Mark the cylinder with etched lines at heights of 165 mm and 185 mm above the bottom of the base plate. The top of the cylinder should be about 225 mm above the bottom of the base plate (the base plate accounts for approximately 10 mm).
- 3.2 Annular template, of diameter 190 mm and containing a centrally located hole of 110 mm diameter (bituminous materials only).
- 3.3 Stop watch or other suitable timing device readable to 0.1 seconds.
- 3.4 Containers, of 10 L and 1 L capacity and fitted with a pouring lip.
- 3.5 Water container, having a capacity of at least 20 L.
- 3.6 Spatula, to aid application of the silicone sealant to the pavement or base of the permeameter.
- 3.7 Marking crayon.
- 3.8 Assorted implements, for cleaning of the pavement before and after testing (for example wire brush, broom, paint scraper).



#### **4 Materials**

The following materials are required:

- 4.1 Silicone sealant, neutral cure (Note 8.1).
- 4.2 Potable water.

#### **5 Procedure**

The procedure shall be as follows:

- 5.1 Remove any loose material from the pavement.
- 5.2 Attach the permeameter to the pavement using the appropriate method as follows:
  - 5.2.1 Granular Material (Note 8.2)
    - a) Apply silicone sealant to the base of the permeameter to a thickness of about 2 mm.
    - b) Press the permeameter firmly onto the pavement.
  - 5.2.2 Sprayed Seal / Asphalt Material
    - a) Place the annular template on the pavement and use the crayon to mark two concentric circles of diameter 100 mm and 200 mm (Note 8.3).
    - b) Apply silicone sealant to the pavement between the two concentric circles and spread it out evenly to a final thickness of about 2 mm using a spatula (Note 8.4).
    - c) Align the base plate with the 200 mm diameter circle and press the permeameter firmly onto the pavement.
- 5.3 Using the containers as appropriate, pour water into the cylinder to fill it to the 165 mm mark.
- 5.4 Check for leaks at the base of the permeameter. If any leakage is observed, caulk the area with additional silicone sealant (Note 8.5).
- 5.5 Continue adding water to the permeameter to maintain the water level at the 165 mm mark for 5 minutes or until 600 mL of water has passed through the pavement.
- 5.6 Immediately add additional water as required to raise the water level to the 185 mm mark. Discontinue the addition of water and record the time taken for the water level to drop from the 185 mm mark to the 165 mm mark to the nearest 0.1 seconds.
- 5.7 Repeat Step 5.6 twice.
- 5.8 Remove the silicone sealant from the base of the permeameter and the bulk of the silicone sealant from the pavement.

## 6 Calculations

Calculations shall be as follows:

6.1 Calculate the mean of the three time measurements ( $t$ ).

6.2 Calculate the volume of the cylinder between 165 mm and 185 mm marks as follows:

$$V = \frac{\pi D^2}{200}$$

where  $V$  = volume of cylinder between 165 mm and 185 mm marks (mL)  
 $D$  = internal diameter of the cylinder (mm)

6.2.1 Calculate the permeability as follows:

$$k = \frac{25.5V}{t}$$

where  $k$  = permeability ( $\mu\text{m/s}$ )  
 $V$  = volume of cylinder between 165 mm and 185 mm marks (mL)  
 $t$  = mean time (s)

## 7 Reporting

The following shall be reported:

- 7.1 Test location including a longitudinal (chainage) and a lateral (offset) reference.
- 7.2 Test site description including pavement type and surface condition.
- 7.3 Permeability to three significant figures ( $\mu\text{m/s}$ ).
- 7.4 Permeability category and description (Table 1), and
- 7.5 The number of this Test Method, that is Q707B.

## 8 Notes on method

- 8.1 Before handling the silicone sealant, the operator should consult the relevant SDS.
- 8.2 For granular materials, trial runs may be necessary to ensure that there is sufficient silicone sealant to effectively seal the permeameter without contaminating the exposed surface with an excess of sealant. It is desirable to keep the diameter of the exposed surface as close as possible to 100 mm.
- 8.3 The dimensions of the annular template allow for a 5 mm gap between the line marked by the crayon and the edge of the template. If necessary, the marking technique should be adjusted to ensure that the internal diameter of the smaller circle is 100 mm.
- 8.4 The sealant should be applied in a manner which spreads the sealant to, but not inside, the 100 mm diameter circle when the permeameter is pressed into position on the pavement.
- 8.5 It is normal for water to escape through the pavement surface at the outside edge of the base plate and this does not constitute leakage.

**Table 1 – Permeability category and description**

Permeability (µm/s)	Category	Description
1.01 – 10.0	B	Moderately permeable
10.1 - 100	C	Permeable
101 - 1000	D	Moderately free draining
1001-10000	E	Free draining

**Figure 1 – Rapid flow field permeameter**

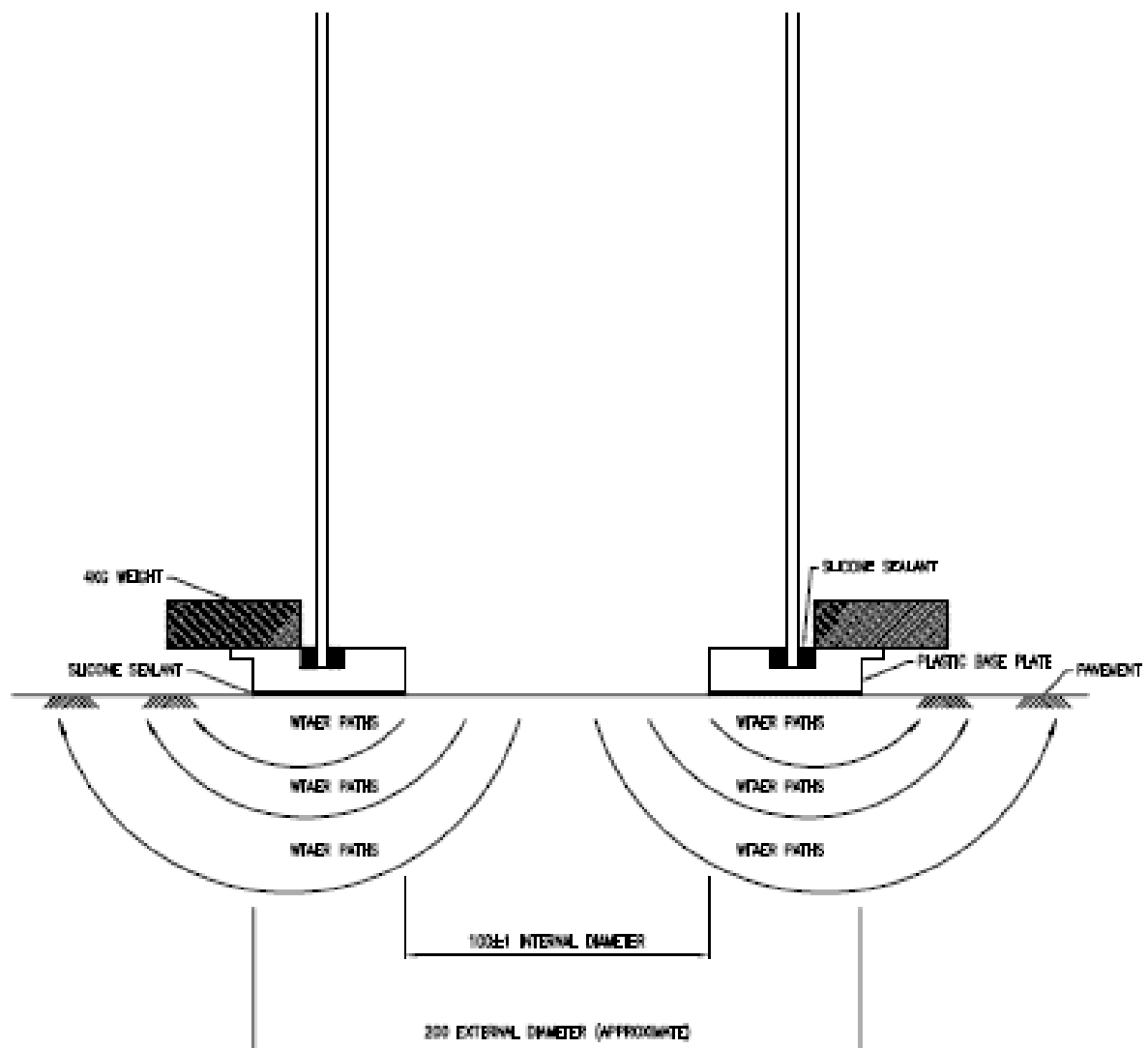
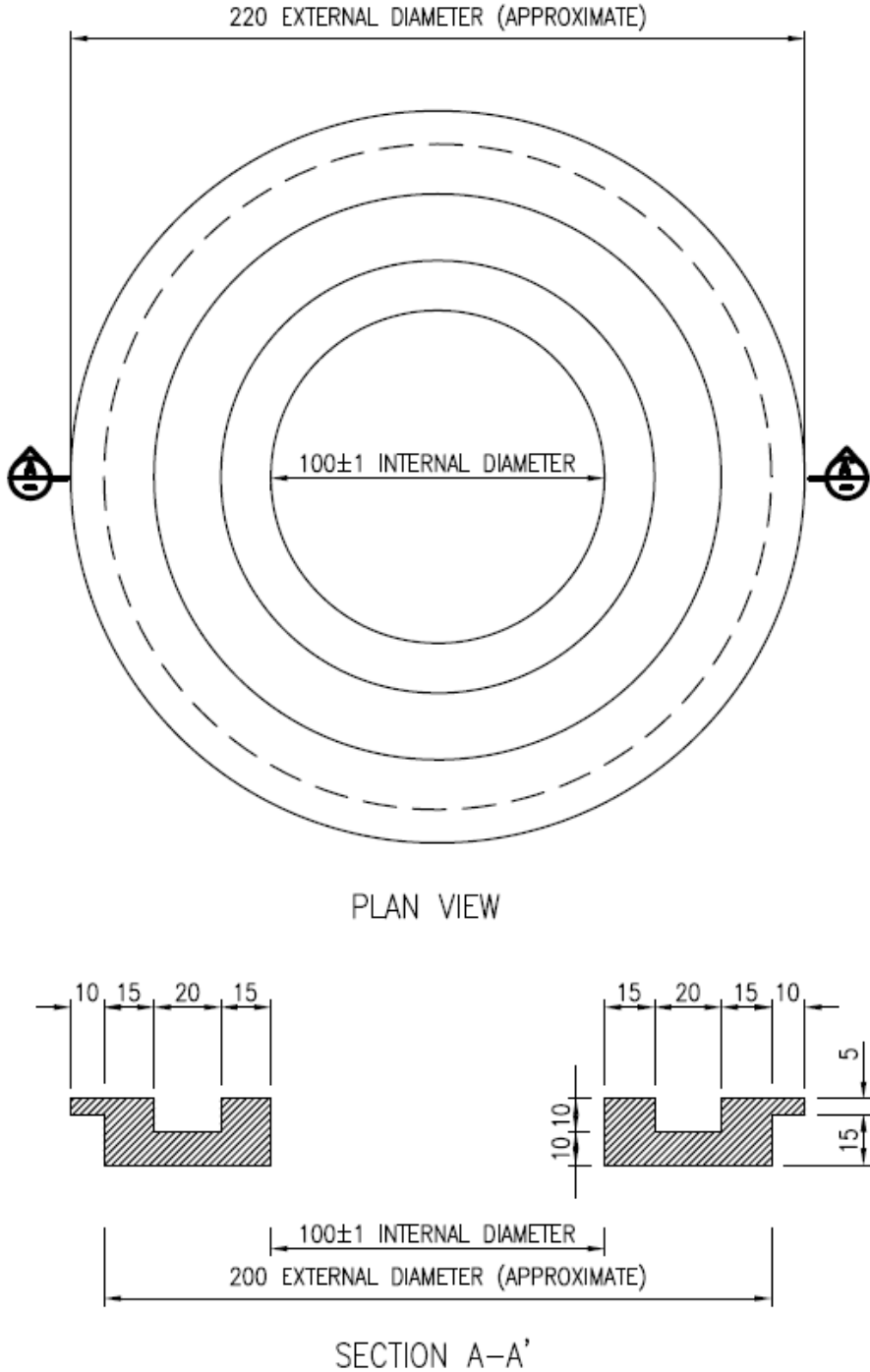

Figure 2 – Plastic base plate



## Test Method Q708B: Road roughness – surface evenness – two laser profilometer

### 1 Source

This Test Method was developed in-house using information obtained from the following technical references:

- ASTM Test Method E 1926-98 (2003): *Standard practice for computing International Roughness Index of roads from profile measurements.*
- ASTM Test Method E 950-09 (2018): *Standard test method for measuring the longitudinal profile of travelled surfaces with an accelerometer-established inertial profiling reference.*
- Austroads Test Method AG:AM/T001: *Pavement Roughness Measurement with an Inertial Profilometer.*

### 2 Scope

This Test Method defines the procedure for measuring the road roughness or surface evenness of road pavements, for construction compliance testing. The roughness is determined from direct measurement of the longitudinal profile in each wheel path using a vehicle-mounted inertial laser based non-contact device (that is, a two laser Profilometer).

The roughness measurement is expressed in terms of International Roughness Index (IRI). This index is obtained by quarter-car simulation at a set speed of 80 km/h using standardised suspension characteristics over a longitudinal profile.

The roughness measurement produced by this Test Method is the section IRI, using the average of the two individual wheel path IRI values obtained separately for each wheel path of a lane.

### 3 Definitions

For this Test Method, the following definitions shall apply:

- 3.1 Longitudinal profile – shape of a pavement surface measured as vertical distances from a datum horizontal plane along the direction of traffic flow.
- 3.2 Inertial profilometer – vehicle mounted laser-based non-contact device used for measuring the longitudinal profile of a road pavement within a given range of wavelengths of surface irregularities.
- 3.3 International Roughness Index (IRI) – mathematical model of the dynamic response of a real motor vehicle travelling along a single wheel path (or wheel track) of longitudinal road profile, referred to as the quarter-car (or World Bank) model. The IRI is expressed in terms of accumulated displacement of the simulated suspension in metres per measured kilometre (m/km). IRI can be reported in different ways, as follows:
  - a) Single Track IRI – the IRI based on a quarter-car model run at 80 km/h over a single wheel path of longitudinal profile (ASTM E1926-08), or
  - b) Section IRI – composite IRI value representing the roughness of a section determined by the Single Track IRI track averaging (quarter-car method). Using the Single Track IRI averaging (quarter-car) method, Section IRI is determined by averaging two individual Single Track IRI values obtained separately in each wheelpath of a lane (at 0.75 m on either side of the centre of the lane mid-track).

- 3.4 Section – test lane is divided into sections that are 10 m in length.
- 3.5 Two laser profilometer –vehicle fitted with lasers and accelerometers that records the longitudinal profile, to Class 1 standard, in each wheel path, at highway speed. The Class 1 profile standard requires a longitudinal sampling interval of less than or equal to 25 mm.
- 3.6 Wheel path – path 0.75 m on either side of the centre of the lane.

#### **4 Apparatus**

The following apparatus is required:

- 4.1 A two laser profilometer comprising the following equipment is required:
  - a) Vehicular platform, capable of transporting the profilometer testing equipment and operators at highway speeds.
  - b) Two accelerometers to establish the inertial reference that enables reference to be maintained at the level of resolution and accuracy required for the laser displacement measurement transducers. Typically, for this application a minimum sample rate of 100 Hz and a range of  $\pm 2$  g is sufficient.
  - c) Two laser displacement transducers that measure the distance between the accelerometers and the road surface. The laser displacement transducers shall be set to ensure mid-range operation during normal testing. Lasers suitable for this application typically have a stand-off height of 300 mm, a measuring range of 200 mm and a sample rate of 8–16 kHz. The lasers shall have a resolution equal to or less than 0.1 mm and an accuracy of 0.5 mm.
  - d) The lasers and accelerometers are mounted 750 mm left and right of the longitudinal centreline of the vehicle.
  - e) Distance measuring rotational encoder capable of measuring the distance travelled to an accuracy of  $\pm 0.1\%$  over a distance of 1.0 km and having a resolution of 5 mm per pulse to enable data acquisition to be triggered at an interval of 25 mm.
  - f) Data logger, capable of capturing the output from the lasers and accelerometers at equal intervals of 25 mm.
  - g) Automatic trigger, capable of starting and/or stopping the data collection may be used, and
  - h) Computer, to calculate the profile from the laser and accelerometer data and analyse the profile data using the quarter-car model to obtain the IRI.
- 4.2 Manufacturer's user manual for operating the test equipment.
- 4.3 Flat base plates, gauge blocks and any other equipment required by the manufacturer user manual for the calibration of the laser displacement transducers.

## **5 Calibration and validation**

Equipment calibration and validation shall be performed as follows:

### **5.1 Equipment calibration**

#### **5.1.1 Distance encoder**

- a) Calibrate the distance encoder by driving the host vehicle over a known distance (1 km to an accuracy of  $\pm 1$  m) and recording the number of pulses produced by the encoder.
- b) Store the calibration factor and associated information (such as, the date and time of calibration). Use this for all subsequent testing until a new distance calibration is performed.
- c) Calibrate the distance encoder whenever fitting a new distance encoder to the vehicle or when changing the wheels or tyres. Re-calibrate periodically to compensate for tyre wear.

#### **5.1.2 Accelerometers**

Undertake calibration and checking of the accelerometers in accordance with the procedures and requirements stated in the manufacturer's user manual.

#### **5.1.3 Laser Displacement Transducers**

- a) Perform the calibration of the laser displacement transducers immediately following any change to the transducers or a change to any part of the host vehicle that may interfere with the existing calibration.
- b) Perform the calibration of the laser displacement transducers using the gauge blocks and flat plates in accordance with the procedures and requirements stated in the manufacturer's user manual.

### **5.2 System validation**

Validate the system as follows every 12 months:

#### **5.2.1** Perform the distance measurement validation in accordance with Austroads Test Method AG:AM/T005.

#### **5.2.2** Perform the roughness measurement validation in accordance with either:

- a) Austroads Test Method AG:AM/T003 except the validation loop is the Transport for New South Wales loop near Newcastle in New South Wales, or
- b) Austroads Test Method AG:AM/T002 using a walking profiler.

### **5.3 Pre-test checks**

#### **5.3.1** If the laser displacement transducers are of a demountable design, calibrate the transducers in accordance with Step 5.1.3 each time the lasers are refitted to the vehicle.

#### **5.3.2** Perform the manufacturer's operation validation test (bounce test) before the start of each day's testing in accordance with the manufacturer's user manual (Note 9.1).

#### **5.3.3** If the recorded roughness during the bounce phase of the test exceeds 0.15 IRI m/km, the validation test has failed and the equipment requires recalibration, repair or replacement as appropriate.

## 6 Procedure

The procedure shall be as follows (Note 9.2):

- 6.1 Select the test length such that it includes sufficient length of pavement to allow for acceleration and deceleration of the vehicle. The test length must include a maximum number of 10 m sections to be planned and tested. This is particularly important where the pavement test surface does not join the existing pavement smoothly or includes incomplete structures. In such situations, allow a length of 30 m at the start and finish of the test length as 'lead in' and 'lead out' areas that are included in the test length but marked as 'lead in' or 'lead out'. Relate all start and finish points to either job chainages or other fixed references such as bridges, intersections, and so on (Note 9.3).
- 6.2 Ensure that the test length is dry and sufficiently clean and note any abnormal surface conditions that could affect the roughness results (Note 9.4).
- 6.3 Select the vehicle speed for testing (Note 9.5).
- 6.4 Check the vehicle tyre pressures against the vehicle manufacturer's recommendation and adjust if necessary, to maintain the calibration of the distance encoder.
- 6.5 Follow the instructions in the manufacturer's user manual to measure the surface profile along each wheel path in the test lane, at a relatively constant speed, with the vehicle travelling along the centre of the lane being tested (Note 9.6), ensuring the following:
  - 6.5.1 The test vehicle is travelling within the operating speed range prior to the defined start point of the test length.
  - 6.5.2 Make no attempt to avoid pavement defects unless they are likely to damage the vehicle and / or jeopardise safety.
  - 6.5.3 Avoid sudden braking and acceleration of the vehicle.
  - 6.5.4 Conduct no testing if the surface is wet or it is raining as this can affect the accuracy of the laser readings.
  - 6.5.5 Conduct no testing in extremely dusty conditions as this can affect the accuracy of the laser readings.
- 6.6 Conduct three test runs for each traffic lane.
- 6.7 Record any events during testing that may affect roughness measurements including the following (Note 9.7):
  - a) Roundabouts
  - b) Bridge
  - c) Railway crossing or grids
  - d) Intersections
  - e) Inspection pit covers
  - f) Side streets
  - g) Change of seal / construction joint
  - h) Pothole / patch / pavement defect, and
  - i) Surface defects related to culverts.



- 6.8 Record any events during testing that may provide location references including the following (Note 9.7):
- a) Bridge
  - b) Intersection
  - c) Railway crossing, and
  - d) Reference points.

## 7 Calculations

Calculations shall be as follows:

- 7.1 From the measured profile of each wheel path, calculate the IRI for each wheel path ( $IRI_L$ ,  $IRI_R$ ) using the quarter-car model (m/km) and follows:

$$IRI_{L\ or\ R} = \frac{\sum IRI}{n}$$

- where  $IRI_{L\ or\ R}$  = Mean left or right wheel path IRI (m/km)  
 $IRI$  = Mean wheel path IRI (m/km)  
 $n$  = 3 (number of test runs)

- 7.2 Calculate the Section IRI as follows:

$$IRI = \frac{IRI_L + IRI_R}{2}$$

- where  $IRI$  = Section IRI (m/km)  
 $IRI_L$  = Left wheel path IRI (m/km)  
 $IRI_R$  = Right wheel path IRI (m/km)

## 8 Reporting

The following shall be reported:

- 8.1 Report the following general information for each test run:
- a) Survey title / file name
  - b) Date and time of test
  - c) Test vehicle / equipment identification
  - d) Operator
  - e) Road number or project number
  - f) Test direction
  - g) Start and end references, for example local project reference or GNSS reference
  - h) Surface type
  - i) Any event recorded during testing that may affect roughness measurements (refer to Step 6.7), and
  - j) Any event recorded during testing for location references (refer to Step 6.8).

- 8.2 Report the following values for each section:
- a) End distance
  - b) Left / outer / passenger wheel path IRI to the nearest 0.01 m/km
  - c) Right / inner / driver wheel path IRI to the nearest 0.01 m/km
  - d) Section IRI to the nearest 0.01 m/km, and
  - e) Test speed (km/h).
- 8.3 The number of this Test Method, that is Q708B.

## **9 Notes on method**

- 9.1 This test simulates a bouncing vehicle travelling along a completely flat surface. The measured profile should be zero as the movement of the laser transducers is expected to be cancelled out by the accelerometers. However, due to electronic noise and other factors, a negligible roughness value is usually recorded.
- 9.2 A driver and operator are required to perform this test unless automatic triggering of the data collection is used.
- 9.3 The lead-in length can be reduced where test vehicles can get up to test speed before the start of the test length, where there is a smooth transition from adjacent pavement to the test length or where the test equipment can handle a reduced lead-in. The lead-out length may only be reduced where there is sufficient distance to brake safely or there is a smooth transition from the test length to the adjacent pavement.
- 9.4 Sweep unsealed pavement layers prior to testing.
- 9.5 Profile based roughness testing is not speed dependent within the recommended operating speed range which is generally 25 to 100 km/h. As a safety precaution, most systems automatically cut power to the lasers if the vehicle speed drops below around 10 km/h. When testing under traffic, adopt a test speed of no less than 15 km/h under the posted or signed speed limit. When testing on construction sites, the test speed is not critical; however, it is preferable but not essential that the selected test speed, within the equipment's operating range, be maintained throughout the test run.
- 9.6 In the absence of defined traffic lanes, conduct testing in areas as directed by the site engineer or supervisor.
- 9.7 The number of events that can be recorded is a function of the test equipment system.

## Test Method Q708C: Road roughness – surface evenness - static level and staff

### 1 Source

This Test Method was developed in-house using information obtained from the following technical references:

- Sayers MV Gillespie TD and Paterson WDO (January 1986) *Guidelines for Conducting and Calibrating Road Roughness Measurements, World Bank Technical Paper Number 46.*
- ASTM Test Method E 1926-98 (2003): *Standard practice for computing International Roughness Index of roads from profile measurements.*
- Austroads Test Method AG:AM/T001: *Pavement Roughness Measurement with an Inertial Profilometer.*

### 2 Scope

This Test Method defines a procedure for measuring the road roughness or surface evenness of road pavements, for construction compliance testing. The roughness is determined from direct measurement of the longitudinal profile in each wheel path using a static level and staff.

Although labour intensive, this Test Method is suitable for testing short sections of pavements which cannot be tested with vehicle-based test methods.

The roughness measurement is expressed in terms of International Roughness Index (IRI). This index is obtained by quarter-car simulation at a set speed of 80 km/h using standardised suspension characteristics over a longitudinal profile.

The single roughness measurement produced by this Test Method is the lane IRI, using the average of the two individual wheel path IRI values obtained separately for each wheel path of a lane. Generally, a test lot is defined as having minimum length of 100 m and a maximum length of 500 m.

### 3 Definitions

For this Test Method, the following definitions shall apply:

- 3.1 Longitudinal profile – shape of a pavement surface measured as vertical distances from a datum horizontal plane along the direction of traffic flow.
- 3.2 Level and staff profiles – automatic surveyor's level and staff can produce profiles to Class 2 standard. Class 2 Profile Standard requires a maximum sample interval, between elevation points, of 500 mm and a precision of the elevation measures of 1.0 mm.

- 3.3 International Roughness Index (IRI) – a mathematical model of the dynamic response of a real motor vehicle travelling along a single wheel path (or wheel track) of longitudinal road profile, referred to as the quarter-car (or World Bank) model. The IRI is expressed in terms of accumulated displacement of the simulated suspension in metres per measured kilometre (m/km). IRI can be reported in different ways, as follows:
- a) Single Track IRI - the IRI based on a quarter-car model run at 80 km/h over a single wheel path of longitudinal profile (ASTM E1926-08).
  - b) Lane IRI - composite IRI value representing the roughness of a road lane section determined by the Single Track IRI track averaging (quarter-car method). Using the Single Track IRI averaging (quarter-car) method, Lane IRI is determined by averaging two individual Single Track IRI values obtained separately in each wheel path of a lane (at 0.75 m on either side of the centre of the lane mid-track).
- 3.4 Wheel path – path 0.75 m on either side of the centre of the lane.

## 4 Apparatus

The following apparatus is required:

- 4.1 Tape, surveyor's tape to locate and mark the positions along the wheel paths of the lane where the elevation measures are to be taken, having an accuracy within 0.2% of its total length.
- 4.2 Level, automatic surveyor's level to provide the height readings from the staff (Note 8.1).
- 4.3 Staff, standard metric staff, which enables 10 mm values to be read directly and the 1 mm values to be visually estimated. A bubble level attached to the staff is required to keep the staff vertical to maintain the precision of the height measurements (Note 8.1).
- 4.4 Computer, to process the height measurements, generate the longitudinal profiles and analyse the profile data using the quarter-car model to obtain the IRI.
- 4.5 Means for securing the tape (for example, weights or adhesive tape).
- 4.6 Means for marking the wheel paths (for example, chalk or paint).

## 5 Procedure

The procedure shall be as follows (Note 8.2):

- 5.1 Clearly mark the transverse location of the wheel paths with chalk or paint at a maximum of 15 m intervals from the start and ensure that the start and end points for each tape set-up are also marked.
- 5.2 Place the tape on a wheel path with the zero position on the tape at the start of the wheel path to be tested. Secure the tape with weights or adhesive tape.
- 5.3 Place the level at a location that allows focusing on the staff at the start of the tape and over as much of the length of the tape as possible. Location of the level in line with the wheel path will minimise viewing adjustment.
- 5.4 At 500 mm intervals along the tape, measure and record the distance between the road surface and an arbitrary height associated with the level.
- 5.5 Move the tape such that the new zero point coincides with the old end point and secure the tape with weights or adhesive tape.

- 5.6 Before moving the level, identify the last measurement in the field notes. Mark the location of the measurement on the road if necessary. This point on the road is the pivot point for the change in instrument height that occurs with the new set-up.
- 5.7 Repeat Steps 5.3 to 5.6 until reaching the end of the test section.
- 5.8 Repeat Steps 5.2 to 5.7 for the other wheel path to be tested.

## 6 Calculations

Calculations shall be as follows:

- 6.1 Using a computer, enter the level measurements for each wheel path and calculate the longitudinal profile for each wheel path using a start chainage of 0 m and an arbitrary start elevation.
- 6.2 Plot the first 10 to 20 m of each longitudinal profile and use this to estimate an elevation at a location 11 m before the profile start, such that a line joining this point to the profile provides a smooth lead-in to the profile. Use the lead-in slope for initialising the IRI computation. The 11 m represents 0.5 seconds of travel at 80 km/h of the quarter-car model.
- 6.3 Add this point (chainage - 11.0 m with its estimated elevation) to the start of the profile data.
- 6.4 From the measured profile of each wheel path, calculate the IRI for each wheel path ( $IRI_L$ ,  $IRI_R$ ) using the quarter-car model (m/km) (Note 8.3).
- 6.5 Calculate the lane IRI as follows (Note 8.3):

$$IRI = \frac{IRI_L + IRI_R}{2}$$

- where  $IRI$  = Lane IRI (m/km)
- $IRI_L$  = Left wheel path IRI (m/km)
- $IRI_R$  = Right wheel path IRI (m/km)

## 7 Reporting

The following shall be reported:

- 7.1 Report the following general information for each test run:
  - a) Survey title / file name
  - b) Date and time of test
  - c) Operators
  - d) Road number or project number
  - e) Test direction and lane description
  - f) Start and end references.
- 7.2 Report the following values for each test lot:
  - a) Test lot end distance
  - b) Left / outer / passenger wheel path IRI to the nearest 0.01 m/km
  - c) Right / inner / driver wheel path IRI to the nearest 0.01 m/km
  - d) Lane IRI to the nearest 0.01 m/km.

7.3 The number of this Test Method, that is Q708C.

## **8 Notes on method**

8.1 This will provide the required Class 2 precision.

8.2 Three operators are recommended for this procedure. One operator positions the staff, the second reads the heights on the level and the third operator records the results.

8.3 For all IRI computations, use an interval of 10 m. These results can then be aggregated to produce a Road Roughness – Surface Evenness value for each test lot.

## Test Method Q708D: Road roughness – surface evenness – walking profiler

### 1 Source

This Test Method was developed in-house using information obtained from the following technical references:

- Sayers MV Gillespie TD and Paterson WDO (January 1986) *Guidelines for Conducting and Calibrating Road Roughness Measurements, World Bank Technical Paper Number 46.*
- ASTM Test Method E 1926-98 (2003): *Standard practice for computing International Roughness Index of roads from profile measurements.*
- Austroads Test Method AG:AM/T001: *Pavement Roughness Measurement with an Inertial Profilometer.*

### 2 Scope

This Test Method defines a procedure for measuring the road roughness or surface evenness of road pavements, for construction compliance testing. The roughness is determined from direct measurement of the longitudinal profile in each wheel path using a walking profiler.

Although slow in operation, this Test Method is suitable for testing short sections of pavements that cannot be tested with vehicle-based test methods.

The roughness measurement is expressed in terms of International Roughness Index (IRI). This index is obtained by quarter-car simulation at a set speed of 80 km/h using standardised suspension characteristics over a longitudinal profile.

The single roughness measurement produced by this Test Method is the lane IRI, using the average of the two individual wheel path IRI values obtained separately for each wheel path of a lane. Generally, a test lot is defined as having minimum length of 100 m and a maximum length of 500 m.

### 3 Definitions

For this Test Method, the following definitions shall apply:

- 3.1 Longitudinal profile – shape of a pavement surface measured as vertical distances from a datum horizontal plane along the direction of traffic flow.
- 3.2 Walking profiler – precision mechanical device with a moveable platform, fitted with a horizontally mounted accelerometer or inclinometer, that can record the longitudinal profile.
- 3.3 International Roughness Index (IRI) – mathematical model of the dynamic response of a real motor vehicle travelling along a single wheel path (or wheel track) of longitudinal road profile, referred to as the quarter-car (or World Bank) model. The IRI is expressed in terms of accumulated displacement of the simulated suspension in metres per measured kilometre (m/km). IRI can be reported in different ways, as follows:
  - a) Single Track IRI – the IRI based on a quarter-car model run at 80 km/h over a single wheel path of longitudinal profile (ASTM E1926-08), or
  - b) Lane IRI – composite IRI value representing the roughness of a road lane section determined by the Single Track IRI track averaging (quarter-car method). Using the Single Track IRI averaging (quarter-car) method, Lane IRI is determined by averaging two individual Single Track IRI values obtained separately in each wheel path of a lane (at 0.75 m on either side of the centre of the lane mid-track).

- 3.4 Wheel path – path 0.75 m on either side of the centre of the lane.

## 4 Apparatus

The following apparatus is required:

- 4.1 Walking profiler, mechanical device with a moveable platform (less than 305 mm in length) fitted with a horizontally-mounted accelerometer, or inclinometer, that can record the longitudinal profile, to Class 1 standard, along a wheel path at a speed of about 800 metres/hour and distance travelled along the wheel path to  $\pm 0.05\%$ . Class 1 Profile Standard specifies a maximum sample interval between elevation points of 25 mm and a precision of the elevation measures of 0.1 mm. The profiler is calibrated in accordance with the procedure specified in the manufacturer's user manual.
- 4.2 Tape measure, to locate and mark the positions along the wheel paths of the lane to provide guidance for the walking profiler operator.
- 4.3 Paint, crayon or similar for marking alignment reference points along the wheel paths to be tested.
- 4.4 Broom, to sweep the test wheel paths, if required.
- 4.5 Thermometer for measuring the ambient operational air temperature of the walking profiler. A thermometer with a range of  $-5^{\circ}$  to  $100^{\circ}\text{C}$  (minimum) and resolution of  $1^{\circ}\text{C}$ , if required by the manufacturer.
- 4.6 Computer, to analyse the individual wheel path and averaged wheel path longitudinal profile data using the quarter-car model to obtain the IRI.
- 4.7 Manufacturer's data acquisition user manual.

## 5 Procedure

The procedure shall be as follows (Note 8.1):

- 5.1 Clearly mark the transverse location of the wheel paths at 3 to 5 m intervals from the start, along the length to be tested, to facilitate accurate tracking of the walking profiler.
- 5.2 Ensure that the wheel paths are free from any loose materials, by sweeping if necessary.
- 5.3 Place the walking profiler at the start point of the first wheel path to be tested. Perform any pre-start checks or measurements required by the manufacturer's manual such as ambient temperature, temperature inside profiler and so on (Note 8.2).
- 5.4 Conduct the survey of the first test wheel path in accordance with the manufacturer's data acquisition user manual selecting metric units in the set-up.
- 5.5 Repeat Steps 5.3 to 5.7 for the second wheel path to be tested.

## 6 Calculations

Calculations shall be as follows:

- 6.1 Load the profile data files for each wheel path from the walking profiler into the analysis software.
- 6.2 From the measured profile of each wheel path, calculate the IRI for each wheel path ( $IRI_L$ ,  $IRI_R$ ) using the quarter-car model (m/km) (Note 8.3).



6.3 Calculate the lane IRI as follows (Note 8.3):

$$IRI = \frac{IRI_L + IRI_R}{2}$$

where  $IRI$  = Lane IRI (m/km)  
 $IRI_L$  = Left wheel path IRI (m/km)  
 $IRI_R$  = Right wheel path IRI (m/km)

## 7 Reporting

The following shall be reported:

7.1 Report the following general information for each test run:

- a) Survey title/file name
- b) Date and time of test
- c) Operator
- d) Road number or project number
- e) Test direction and lane description
- f) Start and end references.

7.2 Report the following values for each test lot:

- a) Test lot end distance
- b) Left/outer/passenger wheel path IRI to the nearest 0.01 m/km
- c) Right/inner/driver wheel path IRI to the nearest 0.01 m/km
- d) Lane IRI to the nearest 0.01 m/km.

7.3 The number of this Test Method, that is Q708D.

## 8 Notes on method

8.1 Only one operator is required to perform this test.

8.2 For example, the ARRB Walking Profiler requires the first 20 m of the wheel path to be tested to be used to carry out the Field Offset Trim in accordance with the manufacturer's data acquisition user manual.

8.3 For all IRI computations, use an interval of 20 m. These results can then be aggregated to produce a Road Roughness – Surface Evenness value for each test lot.

## Test Method Q711A: Field spread rate of cover aggregate - canvas mat

### 1 Source

This Test Method was developed in-house using techniques evolved through internal departmental investigations.

### 2 Scope

This Test Method describes the procedure for the determination of the spread rate of cover aggregate delivered from a mechanical spreading device to determine spreader performance in a trial run prior to use on sprayed sealing works or just beyond the conclusion of a spray run.

### 3 Apparatus

The following apparatus is required:

- 3.1 Balance of suitable capacity, having a resolution of at least 100 g and with a limit of performance within the range of  $\pm 500$  g. A spring balance with a capacity of 30 kg and an attached hook has been found to be suitable.
- 3.2 Square mats, made from heavy duty fabric such as canvas with a reinforced lip around the perimeter and lifting points at each corner. The reinforced lip should be approximately 35 mm in height and stand perpendicular to the mat. The mat area enclosed within the lip should be as close as practicable to one square metre (that is 1 m x 1 m) (Figure 1).
- 3.3 Tape measure, with a resolution of 1 mm.
- 3.4 Small pegs to hold the mats in place during testing.
- 3.5 Brush and scoop.

### 4 Procedure

The procedure shall be as follows:

- 4.1 Determine the length and breadth of each mat used ( $l_i$ ,  $b_i$ ).
- 4.2 Determine the mass of each mat used ( $m_{1i}$ ).
- 4.3 Arrange the one or more of the mats on a level surface in an arrangement so that the spread rate across the spreading width of the aggregate spreader can be determined (Note 7.1). If required, secure the mat(s) to the surface using pegs.
- 4.4 With the spreading device travelling at the desired operating speed and other mechanical spreading equipment (for example gates, rollers) adjusted to the desired settings, drive the spreader over the arrangement of mats. Record all equipment settings.
- 4.5 After the spreader has passed over the mat(s), remove excess aggregate spread over and outside the reinforced lip of the mat. A scoop may be required to move the aggregate from the outside of the mat.
- 4.6 Determine the mass of each mat and aggregate ( $m_{2i}$ ).
- 4.7 Where the spread rate is required as an area spread per volume ( $m^2/m^3$ ), perform an uncompacted bulk density test in accordance with Test Method AS 1141.4 on either a sample of retained aggregate collected from the mat(s) or on a representative sample of aggregate collected prior to spreading.

## 5 Calculations

Calculations shall be as follows:

- 5.1 Calculate the area of each mat as follows:

$$A_i = \frac{l_i b_i}{10^6}$$

where  $A_i$  = area of mat (m<sup>2</sup>)  
 $l_i$  = length of mat (mm)  
 $b_i$  = breadth of mat (mm)

- 5.2 Calculate the spread rate for each mat as follows:

$$R_{1i} = \frac{m_{2i} - m_{1i}}{1000A_i}$$

where  $R_{1i}$  = spread rate for mat (kg/m<sup>2</sup>)  
 $m_{2i}$  = mass of mat and aggregate (g)  
 $m_{1i}$  = mass of mat (g)  
 $A_i$  = area of mat (m<sup>2</sup>)

- 5.3 If required, calculate the mean spread rate when more than one mat is used as follows:

$$R_1 = \frac{\sum R_{1i}}{n}$$

where  $R_1$  = mean spread rate (kg/m<sup>2</sup>)  
 $R_{1i}$  = spread rate for mat (kg/m<sup>2</sup>)  
 $n$  = number of mats used

- 5.4 If required, calculate the spread rate on an area spread per volume basis for each mat as follows:

$$R_{2i} = \frac{1000\rho}{R_{1i}}$$

where  $R_{2i}$  = spread rate for mat (m<sup>2</sup>/ m<sup>3</sup>)  
 $\rho$  = uncompacted bulk density of aggregate (t/ m<sup>3</sup>) obtained from Test Method AS 1141.4  
 $R_{1i}$  = spread rate for mat (kg/m<sup>2</sup>)

- 5.5 If required, calculate the mean spread rate when more than one mat is used as follows:

$$R_2 = \frac{\sum R_{2i}}{n}$$

where  $R_2$  = mean spread rate (m<sup>2</sup>/ m<sup>3</sup>)  
 $R_{2i}$  = spread rate for mat (m<sup>2</sup>/ m<sup>3</sup>)  
 $n$  = number of mats used

## 6 Reporting

The following shall be reported:

- 6.1 Individual spread rate(s) to the nearest 0.1 kg/m<sup>2</sup>  
 6.2 Mean spread rate to the nearest 0.1 kg/m<sup>2</sup>, and

6.3 The number of this Test Method, that is Q711A.

The following may be reported:

6.4 Individual spread rate(s) to the nearest  $1 \text{ m}^2/ \text{m}^3$ , and

6.5 Mean spread rate to the nearest  $1 \text{ m}^2/ \text{m}^3$ .

## 7 Notes on method

7.1 Where several mats are used, they can be placed diagonally across the path of the spreader, avoiding overlap of the mats, while allowing the full width to be sampled.

**Figure 1 – Example of canvas mat**

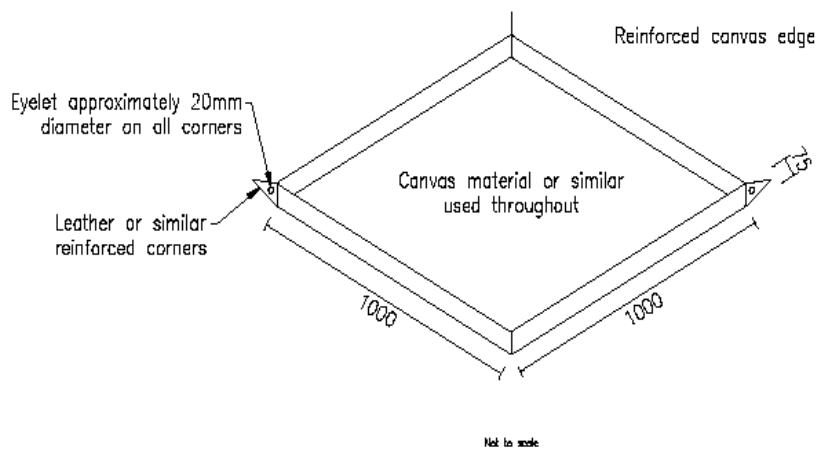

## Test Method Q712: Surface evenness of road surface – three metre straightedge

### 1 Source

This Test Method was developed in-house with reference to Transport for New South Wales Test Method T183: *Surface deviation using a straightedge*.

### 2 Scope

This Test Method describes the procedure for obtaining a measure of the evenness of a pavement surface as determined by the deviation from a three metre straightedge. It is applicable only to the measurement of depressions in the pavement surface and to those straightedges that can be positioned in direct contact with the pavement surface.

### 3 Apparatus

An example of a wedge gauge is contained in MRWA Test Method WA 313.2 Figure 1.

The following apparatus is required:

- 3.1 Straightedge, a 3 m rigid length of metal of either rectangular or I-section shape. The flat working face of the straightedge having deviations along its entire length less than  $\pm 0.5$  mm from true, and less than  $\pm 1.0$  mm from true when resting on supports at both ends. The straightedge will be constructed so that it can rest unsupported on the pavement with its working face in contact with the pavement.
- 3.2 Depth gauge, a suitable device for measuring the gap between the straightedge and the pavement to the nearest 1 mm. One such device is a metal wedge that is slid beneath the straightedge and calibrated in so the gap width can be read directly from the wedge as determined by the distance penetrated by the wedge at its first contact with the straightedge.
- 3.3 Tape measure, steel rule and wheel meter as required.
- 3.4 Broom and/or brush.

### 4 Procedure

The procedure shall be as follows:

- 4.1 Select the test location and remove any loose material from the surface of the pavement using the broom / brush.
- 4.2 Place the straightedge at the required orientation (normally longitudinal or transverse to the centre-line) so that the working face of the straightedge is in contact with the pavement surface (Note 6.1).
- 4.3 Reposition the straightedge, if necessary, to ensure that:
  - a) the straightedge sits firmly on the pavement surface without rocking (Note 6.2)
  - b) the straightedge is at right angles to any linear feature that is under the straightedge (for example, joint, edge, tie-in), and
  - c) for other than joint testing, the length of the straightedge that is cantilevered is minimised (Note 6.3).

- 4.4 Where the test location is on a crown or superelevation of the road or there is any feature that may affect the measurement, record these details.
- 4.5 Visually estimate the point at which the greatest deviation appears to occur between the straightedge and the pavement surface (Note 6.4).
- 4.6 Using the depth gauge, determine the deviation at this point and record the value to the nearest 1 mm.
- 4.7 Repeat Steps 4.5 to 4.6 for other points along the straightedge, as necessary until the maximum deviation is recorded.

## **5 Reporting**

The following shall be reported:

- 5.1 Surface type and layer.
- 5.2 Test location (for example, chainage, direction, lane, offset/wheel path and so on).
- 5.3 Orientation of straightedge relative to centreline.
- 5.4 Maximum deviation to the nearest 1 mm.
- 5.5 Where the cantilever is greater than 750 mm, the length of the cantilever to the nearest 5 mm.
- 5.6 Test location features (for example, convex shape, linear feature, crown, superelevation and so on).
- 5.7 The number of this Test Method, that is Q712.

## **6 Notes on method**

- 6.1 Where a joint is to be tested, position one end of the straightedge directly over the joint with the remainder of the straightedge supported on the surface to be tested.
- 6.2 Where a convex surface prevents the positioning of the straightedge firmly on the pavement without rocking, terminate the test. Record “Convex shape” for the test location.
- 6.3 Where the cantilever is greater than 750 mm, measure the length of cantilever to the nearest 5 mm.
- 6.4 Maximum deviation may be under the supported or cantilevered portion of the straightedge.

## Test Method Q713: Skid resistance – mobile, variable slip technique

### 1 Source

This Test Method shall be performed in accordance with ASTM E1859–06, *Standard test method for Friction Coefficient Measurements Between Tire and Pavement Using a Variable Slip Technique*, but with the following changes, as detailed below. These changes are due to:

- a) amendment specific to the ViaFriction Skid Tester
- b) local terminology and operational procedures.

The changes to the ASTM Standard Test Method were developed in-house based on information obtained from the following technical references:

- ViaFriction (2008) *User Manual for ViaFriction Meter*. ViaTech AS, Norway.
- PIARC (1995) *International PIARC Experiment to Compare and Harmonize Texture and Skid Resistance Measurements*, PIARC Technical Committee on Surface Characteristics C.1.
- HERMES (2006) *Harmonization of European Routine and Research Measurement Equipment for Skid Resistance*, FEHRL Report 2006/01.
- ViaTech (2009) *ViaFriction Calibration, Document No. DOC500074* (refer section 2.2.1), Dagali Airport, Norway, 16th June 2009.
- Transport and Main Roads (2010) *Temperature Influence on Skid Resistance Measurement (Asphalt Surfaces)*. *Pavement Performance and Investigation Report No. PR7000397/0090/0140* prepared for Director (Road Asset Management), March 2010.

### 2 Scope

This Test Method covers the direct measurement of the braking force coefficient of friction at a slip speed of 60 km/h ( $F_{60}$ ) and the speed dependency ( $S_p$ ) of that measure (that is, the two components of International Friction Index (IFI)) using the ViaTech – ViaFriction skid tester operating in variable slip mode. Also measured during the test is Peak Friction, the slip speed at which it occurred ( $V_{crit.}$ ) and the coefficient of friction at a slip speed of 30 km/h ( $F_{30}$  – commonly referred to as European Friction Index (EFI)).

### 3 Definitions

For this method, the definitions in ASTM E1859-06 shall apply, except as follows:

- 3.2.1 peak friction number,  $n$  is referred to as Peak Friction
- 3.2.1.1 SNF peak(S) –  $S$  is the slip speed at which peak friction occurs and is referred to as  $V_{Crit}$ .
- 3.2.1.1 SNF peak = Peak Friction x 100
- 3.2.2.1 SNF Characteristic is the slip friction at a specified slip speed. At the 60 km/h adopted slip speed, this friction value is denoted as  $F_{60}$  where  $SNF(60)/100 = F_{60}$ .
- 3.2.3 “slip – to skid Friction number” is the friction value at wheel lockup and is only a meaningful measure when testing at constant speed. This value is not reported.

- 3.2.5 slope indicator is equivalent to Speed Number and is designated as  $S_p$ .  $F_{60}$  and  $S_p$  are the two components of International Friction Index (IFI).
- 3.2.6 tire longitudinal stiffness indicator is not recorded or reported.

## 4 Apparatus

The apparatus required is in accordance with ASTM E1859-06, except as follows:

- 5.4.1.1 The ViaFriction skid tester operates under a 71 kg (156.1 lbs) load not the ASTM specified 1.423 kN (320 lbf) load.
- 5.4.1.2 Initial calibration is supplied by the manufacturer against a reference device used in the PIARC International Trial. Annual stability of calibration is undertaken using a relative calibration approach over a number of established test sites.
- 5.4.5 The distance encoders on the ViaFriction skid tester have a resolution of 100 and 25 mm on the test wheel and test vehicle respectively. With a brake cycle of 0.5 seconds, at a test speed of 60 to 80 km/h, the 100 mm distance resolution on the test wheel provides approximately 100 data points in the braking cycle that provides a slip speed resolution of < 1 km/h.

## 5 Test procedure

The procedure shall be as follows:

- 5.1 Testing is not speed dependent and conducted under traffic conditions, at test speeds between 40 and 90 km/h. When testing on construction sites or runways (that is, not under traffic), a test speed of 60 to 80 km/h is preferred.
- 5.2 Select a water film depth of 0.5 mm for road testing and a 1.0 mm water film depth for runway testing.
- 5.3 Unless specified, carry out testing in the left hand wheel path of the test lane.
- 5.4 Although the testing operation is continuous, at the adopted brake profile (ramp setting) of 500 ms, the braking system takes 0.5 seconds to do a test and 4 to 5 seconds to dissipate its energy and reset for the next test. At a test speed of 80 km/h the combined braking and reset cycles take around 5 seconds and cover a travelled distance of 100 to 120 m. Therefore, the minimum test intervals are 100 and 150 m for speed zones  $\leq 60$  km/h and  $> 60$  km/h respectively.
- 5.5 Record the water temperature and ambient temperature during testing in addition to the ViaFriction test unit's automatic acquisition of surface temperature.

## 6 Calculations

Calculate as follows:

- 6.1 The ViaFriction system reports for each test interval, the test speed, peak friction,  $V_{crit}$ ,  $F_{30}$ ,  $F_{60}$ , Friction Slip Slope, surface temperature and GNSS coordinates. The Friction Slip Slope can be converted to  $S_p$  using the following relationship:

$$S_p = \frac{-1}{FSS}$$

where  $S_p$  = slope indicator  
 $FSS$  = Friction Slip Slope



6.2 The recorded  $F_{60}$  skid resistance value shall be temperature corrected as follows:

6.2.1 The Transport and Main Roads adopted reference surface temperature for skid resistance measurement correction is 30°C. It is proposed that this be raised to 35°C for areas west of the Charleville, Alpha, Hughenden, Georgetown and Weipa line to reflect the higher operating surface temperature conditions in that area (TMR (2010)).

6.2.2 For correction of  $F_{60}$  skid resistance results to a 30°C reference temperature, the following relationship shall be used:

$$F_{60_{30}} = F_{60_{(t)}} + 0.0015(t) - 0.045$$

where  $F_{60_{30}}$  = corrected  $F_{60}$  value for a 30°C reference temperature

$F_{60_{(t)}}$  = recorded  $F_{60}$  value at  $t^{\circ}\text{C}$

$(t)$  = surface temperature at time of test ( $^{\circ}\text{C}$ )

6.2.3 For correction to 35°C reference temperature, the following relationship shall be used:

$$F_{60_{35}} = F_{60_{(t)}} + 0.0015(t) - 0.0525$$

where  $F_{60_{35}}$  = corrected  $F_{60}$  value for a 35°C reference temperature

$F_{60_{(t)}}$  = recorded  $F_{60}$  value at  $(t)^{\circ}\text{C}$

$(t)$  = surface temperature at time of test ( $^{\circ}\text{C}$ )

## 7 Reporting

For each test interval the following shall be reported:

7.1 Location of the test (road, chainage, lane, wheel path, GNSS coordinates).

7.2 Date and time of test.

7.3 International Friction Index comprising the two components, that is, the temperature corrected  $F_{60}$  friction coefficient to the nearest 0.01 and the speed dependency ( $S_p$ ) factor to the nearest 1 km/h (Note 8.1).

7.4 Other measured friction coefficients and parameters (optional).

7.5 Ambient and water temperatures (optional) (Note 8.2).

7.6 The number of this Test Method, that is Q713.

## 8 Notes on method

8.1 The speed dependency ( $S_p$ ) factor is the slope of the friction/slip speed curve at 60 km/h. As the coefficient of friction is dimensionless,  $S_p$  is expressed in km/h.

8.2 These are only recorded for future use with possibly more refined temperature correction procedures.

## Test Method Q714: Skid resistance – mobile, continuous reading, fixed slip technique

Perform this test in accordance with ASTM E2340/E2340M *Standard Test Method for Measuring the Skid Resistance of Pavements and Other Trafficked Surfaces Using a Continuous Reading, Fixed-Slip Technique* and ASTM E1960 *Standard Practice for Calculating International Friction Index of a Pavement Surface*, but with the following changes, as detailed below. These changes are due to:

- a) amendment specific to the ViaFriction Skid Tester.
- b) local terminology and operational procedures.

### 1 Scope

This Test Method covers the measurement of the braking force coefficient of friction at a slip speed of 60 km/h (that is, F60, the friction component of International Friction Index (IFI)) using the ViaTech – ViaFriction skid tester operating in continuous fixed slip mode.

The changes were developed in house based on information obtained from the following technical references:

- ViaFriction (2008) *User Manual for ViaFriction Meter*, ViaTech AS, Norway.
- PIARC (1995) *International PIARC Experiment to Compare and Harmonize Texture and Skid Resistance Measurements*, PIARC Technical Committee on Surface Characteristics C.1.
- Henry JJ Marasteanu M (1992) *Models to Harmonize Methods for Measuring Road Friction*, Second International Symposium on Road Surface Characteristics, Berlin, Germany, June 1992.
- Q705 (2010) *Texture Depth (Sand Patch)* (withdrawn), Test Method Q705 (Austroads Test Method AG:PT/T250), Materials Testing Manual.
- ViaTech (2009) *ViaFriction Calibration. Document No. DOC500074* (refer Section 2.2.1), Dagali Airport, Norway, 16th June 2009.
- Norsesmeter (1996) – *A Primer on Modern Runway Surface Friction Measurement*. Norsesmeter Friction AS.
- Transport and Main Roads (2010) – *Temperature Influence on Skid Resistance Measurement (Asphalt Surfaces). Pavement Performance and Investigation Report No. PR7000397/0090/0140* prepared for Director (Road Asset Management), March 2010.

For test speeds greater than 60 km/h, the slip ratio is selected to enable direct measurement of the braking force coefficient of friction at a slip speed of 60 km/h ( $F_{60}$ ). For slower test speeds, the maximum effective slip ratio of 90% is selected and the measured coefficient of friction is corrected to  $F_{60}$  using the Penn State relationship (Henry JJ Marasteanu M (1992)), as adopted by PIARC (1995) and described in ASTM (E1960 – 07).

The Penn State relationship uses the speed dependency factor ( $S_p$ ), the second component of International Friction Index.  $S_p$  can be measured directly with a supplementary test using the Via Friction in variable slip mode (Q713) or calculated from surface texture measurements (Q705 (2010)) and the PIARC (1995) relationship for device A8 (Sand Patch Test using glass beads).

## 2 Test procedure

- 2.1 Carry out testing at the test speeds and their associated slip ratio in Table 1. Note: 100% slip is a locked wheel.
- 2.2 Select a water film depth of 0.5 mm for road testing and a 1.0 mm water film depth for runway testing.
- 2.3 Unless specified, carry out testing in the left hand wheel path of the test lane.
- 2.4 Although testing is continuous, process data in 10 m (maximum) test lots. Report either, individually, or averaged into reporting lots of 100 m minimum length.
- 2.5 Record surface temperature, water temperature and ambient temperature.

## 3 Data processing

### 3.1 Transformation sequence

- 3.1.1 Convert the measured friction to a slip speed of 60 km/h – Speed Correction.
- 3.1.2 Convert the speed corrected friction measure to  $F60$  – the friction component of IFI.
- 3.1.3 Temperature correction of  $F60$ .

### 3.2 Speed correction

- 3.2.1 The first step is to convert the measured friction level to what would have been measured at a slip speed of 60 km/h using the Penn State relationship:

$$FR60 = FRS \cdot e^{\frac{(S-60)}{S_p}}$$

- where
- $FR60$  = adjusted value of friction to a slip speed of 60 km/h
  - $FRS$  = friction measured at slip speed  $S$
  - $S$  = slip speed at which the friction value was measured (km/h)
  - $S_p$  = speed dependency factor

- 3.2.2 The speed dependency factor ( $S_p$ ) is determined either by direct measurement in variable slip mode (Q713 (2011)) or from Sand Patch texture depth ( $MTD$ ) in accordance with PIARC (1995) as follows:

$$S_p = -11.6 + (113.6MTD)$$

- where
- $S_p$  = speed dependency factor
  - $MTD$  = sand patch texture depth (mm)

### 3.3 Harmonisation

- 3.3.1 The next step is to convert the adjusted friction measure ( $FR60$ ) to the harmonised International Friction Index (IFI) friction measure  $F60$  in accordance with PIARC (1995) as follows:

$$F60 = A + (B \cdot FR60)$$

- where
- $F60$  = Harmonised International Friction Index (IFI)
  - $A$  = constant for reference test device used in PIARC harmonisation trial
  - $B$  = constant for reference test device used in PIARC harmonisation trial
  - $FR60$  = adjusted value of friction to a slip speed of 60 km/h

- 3.3.2 The ViaFriction test unit is internally calibrated, against OSCAR, a reference device used in the PIARC harmonisation trial. This relationship in accordance with ViaTech (2009) is:

$$OSCAR = -0.0366 + (0.9934.ViaFriction)$$

- 3.3.3 The relationship for OSCAR in accordance with Norsemeter (1996) is:

$$F60 = -0.000074 + (1.000022.FR60)$$

- 3.3.4 In practical terms, as the A & B constants nearly equal zero and 1, the OSCAR and units calibrated against it, measure  $F60$  directly when testing at a 60 km/h slip speed. Therefore, this step is not required for ViaFriction test results.

### 3.4 Temperature correction

- 3.4.1 The TMR adopted reference temperature for skid resistance measurement correction is 30°C. It is proposed that this be raised to 35°C for areas west of the Charleville, Alpha, Hughenden, Georgetown and Weipa line to reflect the higher operating surface temperature conditions in that area (TMR (2010)).

- 3.4.2 For correction of  $F60$  skid resistance results to a 30°C reference temperature, the following relationship shall be used:

$$F60_{30} = F60_{(t)} + 0.0015(t) - 0.045$$

where  $F60_{30}$  = corrected  $F60$  value for a 30°C reference temperature

$F60_{(t)}$  = recorded  $F60$  value at  $t^{\circ}\text{C}$

$(t)$  = surface temperature at time of test ( $^{\circ}\text{C}$ )

- 3.4.3 For correction to 35°C reference temperature, the following relationship shall be used:

$$F60_{35} = F60_{(t)} + 0.0015(t) - 0.0525$$

where  $F60_{35}$  = corrected  $F60$  value for a 35°C reference temperature

$F60_{(t)}$  = recorded  $F60$  value at  $t^{\circ}\text{C}$

$(t)$  = surface temperature at time of test ( $^{\circ}\text{C}$ )

### 3.5 Application of speed and temperature correction

Speed correction shall be applied first at the processing 10 m test lot stage when the calculated slip speed varies by more than  $\pm 3\%$  of the targeted slip speed. Temperature correction shall be applied last at the reporting test lot stage using the average surface temperature recorded for the test lot.

## 4 Calibration

The ViaFriction has been dynamically calibrated by the manufacturer (ViaTech) against OSCAR, a reference device used in the PIARC (1995) trial. The data produced by ViaFriction, when testing at a slip speed of 60 km/h, is a direct measure of  $F60$ , the friction component of International Friction Index. In Australia, we do not undertake static calibration tests but rely in the equipments in-built diagnostics and regular dynamic reference calibration checks over our Nudgee Beach Road test site and the Department's Mt. Cotton test track in Brisbane. For major projects, dynamic reference calibration checks are carried out before and after each skid resistance survey.

**Table 1 – Nominal test speeds and slip ratios**

Posted speed (km/h)	Test speed (km/h)	Slip ratio (%)	Friction measure
110	90	67	<i>FR60</i>
100	80	75	<i>FR60</i>
90	80	75	<i>FR60</i>
80	80	75	<i>FR60</i>
70	70	86	<i>FR60</i>
60	60	90*	<i>FR54**</i>
50	50	90*	<i>FR45**</i>
40	40***	90*	<i>FR36**</i>

\* Maximum effective slip ratio

\*\* Needs to be corrected to *FR60* using a measured or calculated  $S_p$

\*\*\* Minimum test speed.

## Test Method Q719: Field spread rate of solid stabilisation agents - fabric mat

### 1 Source

This Test Method was developed in-house using techniques evolved through internal departmental investigations.

### 2 Scope

This Test Method describes the procedure for the determination of the spread rate of solid stabilising agents delivered from a mechanical spreading device to determine spreader performance in terms of spread rate and uniformity of distribution.

### 3 Apparatus

The following apparatus is required:

- 3.1 Balance of suitable capacity, having a resolution of at least 100 g and with a limit of performance within the range of  $\pm 500$  g. A spring balance with a capacity of 30 kg and an attached hook has been found to be suitable.
- 3.2 Square mats, made from heavy duty fabric such as canvas or polyester with a reinforced lip around the perimeter and lifting points at each corner. The mat should be as close as practicable to one square metre (that is 1 m x 1 m).
- 3.3 Tape measure, with a resolution of 1 mm.
- 3.4 Small masses or pegs to hold the mats in place during testing.
- 3.5 Brush and scoop.

### 4 Procedure

The procedure shall be as follows:

- 4.1 Determine the length and breadth of each mat used ( $l_i$ ,  $b_i$ ).
- 4.2 Determine the mass of each mat used ( $m_{1i}$ ).
- 4.3 Arrange one or more of the mats on a level surface so that the spread rate across the spreading width of the spreader can be determined (Note 7.1). Secure the mat(s) to the surface using masses or pegs.
- 4.4 After the spreader has passed over the mat(s), carefully brush the stabilising agent from the periphery of each mat towards the centre of the mat. A scoop may be required to move the stabilising agent from the periphery of the mat.
- 4.5 Determine the mass of each mat and stabilising agent used ( $m_{2i}$ ).
- 4.6 Return the stabilising agent to the surface and spread over the area previously covered by the mat(s).

## 5 Calculations

Calculations shall be as follows:

- 5.1 Calculate the area of each mat as follows:

$$A_i = \frac{l_i b_i}{10^6}$$

where  $A_i$  = area of mat (m<sup>2</sup>)  
 $l_i$  = length of mat (mm)  
 $b_i$  = breadth of mat (mm)

- 5.2 Calculate the spread rate for each mat as follows:

$$R_i = \frac{m_{2i} - m_{1i}}{1000A_i}$$

where  $R_i$  = spread rate for mat (kg/m<sup>2</sup>)  
 $m_{2i}$  = mass of mat and stabilising agent (g)  
 $m_{1i}$  = mass of mat (g)  
 $A_i$  = area of mat (m<sup>2</sup>)

- 5.3 Calculate the mean spread rate when more than one mat is used as follows:

$$R = \frac{\sum R_i}{n}$$

where  $R$  = mean spread rate (kg/m<sup>2</sup>)  
 $R_i$  = spread rate for mat (kg/m<sup>2</sup>)  
 $n$  = number of mats used

## 6 Reporting

The following shall be reported:

- 6.1 Individual spread rate(s) to the nearest 0.1 kg/m<sup>2</sup>.  
 6.2 Mean spread rate to the nearest 0.1 kg/m<sup>2</sup>, and  
 6.3 The number of this Test Method, that is Q719.

## 7 Notes on method

- 7.1 Where several mats are used, they can be placed diagonally across the path of the spreader, avoiding overlap of the mats, while allowing the full width to be sampled.

## Test Method Q720: Loose aggregate on sprayed seals

### 1 Source

This Test Method is based on the TfNSW Test Method T277: *Measurement of loose aggregate on sprayed seals*.

### 2 Scope

This Test Method describes the procedure for determining the quantity of loose aggregate particles on the surface of a sprayed seal constructed with aggregates of 10 mm nominal size or larger.

### 3 Apparatus

The following apparatus is required:

- 3.1 Square template, of rigid construction and with internal dimensions as close as practicable to 1 m by 1 m. The template should be designed to allow ready removal of aggregate from the template area.
- 3.2 Brush, a stiff-bristled brush suitable for removing loose aggregate particles.
- 3.3 Container, suitable for collecting aggregate particles removed from the template area.
- 3.4 Tape measure, with a resolution of 1 mm.
- 3.5 Sieve, 6.70 mm conforming to ISO 3310.

### 4 Procedure

The procedure shall be as follows:

- 4.1 Determine the length and breadth of the template ( $l$ ,  $b$ ).
- 4.2 Place the template on the sprayed seal surface.
- 4.3 Using the brush, remove any loose aggregate particles from within the template area and collect them in the container, taking care not to dislodge any aggregate particles which are embedded in the seal binder.
- 4.4 Screen the collected loose aggregate particles over a 6.70 mm sieve.
- 4.5 Count the number of aggregate particles retained on the 6.70 mm sieve ( $n$ ).

### 5 Calculations

Calculations shall be as follows:

- 5.1 Calculate the area of the template as follows:

$$A = \frac{lb}{10^6}$$

where  $A$  = area of template (m<sup>2</sup>)  
 $l$  = length of template (mm)  
 $b$  = breadth of template (mm)



5.2 Calculate loose aggregate as follows:

$$L = \frac{n}{A}$$

where  $L$  = loose aggregate (particles/m<sup>2</sup>)  
 $A$  = area of template (m<sup>2</sup>)  
 $n$  = number of loose aggregate particles

## 6 Reporting

The following shall be reported:

- 6.1 Loose aggregate to the nearest 1 particles/m<sup>2</sup>.
- 6.2 The stage or time at which the testing was performed, for example, “after rolling and before sweeping”, and
- 6.3 The number of this Test Method, that is Q720.

## Test Method Q721: Torsional shear strength of pavement layers

### 1 Source

This Test Method was developed in-house using information obtained from internal departmental investigation.

### 2 Scope

This Test Method describes the procedure for determining the strength of the bond between different layers within a road pavement using torsional shear. It is applicable to asphalt layers, concrete layers and sprayed seal surfacing. Testing may be performed in the field using insitu coring, or in the laboratory using extracted core specimens.

### 3 Apparatus

The following apparatus is required:

- 3.1 Bond plate, steel cylindrical plate of 100 mm diameter having a roughened surface on one end, and a socket attached to the other end to accommodate a torque wrench.
- 3.2 Clamping apparatus, steel jig or bench vice (laboratory testing only).
- 3.3 Torque wrench, with a resolution of 1 Nm, allowing torque measurements up to 270 Nm and conforming to ISO 6789.
- 3.4 Temperature measuring device, graduated to 1°C or less with an uncertainty of no more than 0.5°C, and having a temperature range which includes the temperature of the field or laboratory test specimen.
- 3.5 Measuring device, suitable for measuring the thickness of a test specimen and having a resolution not exceeding 1 mm.
- 3.6 Stiff wire brush.

### 4 Materials

The following materials are required:

- 4.1 Adhesive, suitable for fixing the bond plate to the asphalt, concrete or sprayed seal as appropriate (Note 8.1).

### 5 Specimen preparation

The specimen shall be prepared as follows:

- 5.1 For field testing, core the layer to be tested to a depth exceeding its thickness using the dry coring method specified in Test Method AS 2891.1.2 but do not extract the core specimen (Note 8.2).
- 5.2 For laboratory testing, core the layer to be tested to a depth exceeding its thickness using the dry coring method specified in Test Method AS 2891.1.2. The depth of the core shall be sufficient to allow the underlying layer to be attached to the clamping apparatus (Note 8.2).

## 6 Procedure

The procedure shall be as follows:

- 6.1 Clean the top of the cored layer or core specimen using the wire brush to remove any dust or other foreign matter.
- 6.2 Apply the adhesive to the roughened end of the bond plate to provide a film thickness of about 3 mm.
- 6.3 Position the prepared bond plate on top of the cored layer or core specimen and press firmly to ensure thorough contact. Remove any excess adhesive squeezed outside the contact area.
- 6.4 Allow the adhesive to cure for a minimum of 12 hours.
- 6.5 For laboratory testing, fix the underlying layer of the core specimen firmly in the clamping apparatus.
- 6.6 Attach the torque wrench to the bond plate and apply a starting torque appropriate for the bond type.
- 6.7 Increase the torque in 5 Nm increments until the test specimen shears or cracks.
- 6.8 Record the torque at which shearing or cracking occurs.
- 6.9 Measure the temperature of the test specimen.
- 6.10 Measure the thickness of the test specimen.
- 6.11 Record a description of the bond failure (Note 8.3).

## 7 Reporting

The following shall be reported:

- 7.1 Torque at which shearing occurs to the nearest 1 Nm.
- 7.2 Temperature of the test specimen to the nearest 1°C.
- 7.3 Thickness of the test specimen to the nearest 1 mm.
- 7.4 Description of the bond failure.
- 7.5 The number of this Test Method, that is Q721.

## 8 Notes on method

- 8.1 Hilti general purpose adhesive two part paste No 125 has been found suitable.
- 8.2 Core diameter can be 100 mm or 150 mm with the smaller diameter being sufficient where there is a strong bond (for example, the bond between dense graded asphalt and a sprayed seal surfacing).
- 8.3 Bond failure shall be described as:
  - a) specimen sheared cleanly at layer interface, or
  - b) specimen sheared through upper and/or lower layer.

## Test Method Q723: Proof rolling test

### 1 Source

This Test Method is based on Transport for New South Wales Test Method T198: *Proof rolling test*. It differs from the method as follows:

- a) remove pneumatic tyred static roller from apparatus list
- b) allow use of a water tanker with either 7,000 litres or 10,000 litres of water
- c) remove contractual terminology
- d) remove requirement to submit a proof rolling plan and report the rolling pattern, and
- e) remove requirement water and re-roll layer if testing is delayed by more than 12 hours.

### 2 Scope

This Test Method sets out a procedure for assessing the stiffness and uniformity of compaction of a road formation during construction, by observing surface deformation under a moving heavy roller.

The timing of the proof rolling test will be specified in the relevant technical specification.

### 3 Definition

For this method, the following definition shall apply:

- 3.1 Proof rolling - subjectively assessed deformation test performed by an operator experienced in proof rolling (Note 8.1). The operator must assess whether the transient surface deformation under the equipment is perceptible or not. Perceptible deformation may be visible permanent deformation or elastic (springing or resilient) deformation.

### 4 Apparatus

The following apparatus is required:

- 4.1 Proof roller (Note 8.2), can be either:
  - a) water tanker with tandem rear axle, internal baffles to minimise sloshing and a minimum 600 kPa tyre pressure. The water tank must contain at least 10,000 litres of water during use
  - b) water tanker with single rear axle, internal baffles to minimise sloshing and a minimum 600 kPa tyre pressure. The water tank must contain at least 7,000 litres of water during use, or
  - c) other equipment with at least the same rear axle loading as the water tanker, may be used (Note 8.1).
- 4.2 Tyre pressure gauge.

### 5 Materials

The following materials are required:

- 5.1 Potable or recycled water for filling water tank.

## **6 Procedure**

The procedure shall be as follows:

### **6.1 Preparation**

- 6.1.1 The layer to be tested must be compacted in accordance with the relevant construction specification. The surface must be level, homogeneous in appearance, with no large protruding objects or significant surface depressions, and free of loose material.

### **6.2 Rolling procedure**

- 6.2.1 Test the layer by operating the equipment at a speed in the range 3-10 km/h, as determined by the operator. The rolling pattern must cover the full area of the lot, with successive passes of the equipment offset laterally by 40 to 50%.
- 6.2.2 When standing beside the equipment, the operator, must assess the surface deformation under the roller as perceptible or not perceptible at specific locations, and as uniform or non-uniform over the area of the lot.

## **7 Reporting**

The following shall be reported:

- 7.1 Details of equipment used to include the type, model, gross mass, tyre pressures and registration / identification number.
- 7.2 The time of proof rolling after final compaction, and whether the surface was wetted prior to proof rolling.
- 7.3 Report the surface deformation as:
- a) perceptible or non-perceptible for specific locations
  - b) uniform or non-uniform over the lot.
- 7.4 The number of this Test Method, that is Q723.

## **8 Notes on method**

- 8.1 Transport and Main Roads Technical Specifications will nominate who shall witness this testing, usually the Contract Administrator or their nominated representative. The Contract Administrator may also approve the use alternative apparatus in the contract.
- 8.2 The static smooth steel drum roller is not permitted as it may not identify localised soft areas as the rigid drum could bridge these areas.