

Manual

**TMR Surveying Standards
Part 2 – Geomatic Survey Types**

January 2022

Copyright

© The State of Queensland (Department of Transport and Main Roads) 2022.

Licence



This work is licensed by the State of Queensland (Department of Transport and Main Roads) under a Creative Commons Attribution (CC BY) 4.0 International licence.

CC BY licence summary statement

In essence, you are free to copy, communicate and adapt this work, as long as you attribute the work to the State of Queensland (Department of Transport and Main Roads). To view a copy of this licence, visit: <https://creativecommons.org/licenses/by/4.0/>

Translating and interpreting assistance



The Queensland Government is committed to providing accessible services to Queenslanders from all cultural and linguistic backgrounds. If you have difficulty understanding this publication and need a translator, please call the Translating and Interpreting Service (TIS National) on 13 14 50 and ask them to telephone the Queensland Department of Transport and Main Roads on 13 74 68.

Disclaimer

While every care has been taken in preparing this publication, the State of Queensland accepts no responsibility for decisions or actions taken as a result of any data, information, statement or advice, expressed or implied, contained within. To the best of our knowledge, the content was correct at the time of publishing.

Feedback

Please send your feedback regarding this document to: tmr.techdocs@tmr.qld.gov.au

Foreward

The information in this Part 2 of the TMR Surveying Standards must be read in conjunction with Part 1 and Schedule 1. Part 1 contains general information, including the department's standard datums and Surveyor qualification requirements that are applicable to every survey for the department. Schedule 1 details the departments' field codes, their linestyles and the models they belong to. Situational examples show where and how to use the field codes.

Contents

- 1 Ground and Feature Model surveys1**
- 1.1 Introduction 1
 - 1.1.1 Purpose1
 - 1.1.2 Surveyor qualifications1
- 1.2 Overview 1
 - 1.2.1 Completeness of information.....2
- 1.3 GFM components 2
 - 1.3.1 Location2
 - 1.3.2 Definition..... 11
 - 1.3.3 Presentation 18
 - 1.3.4 Quality 23
- 1.4 Purpose of Survey 24
- 1.5 Purpose – Pavement 24
 - 1.5.1 Full pavement reconstruction 25
 - 1.5.2 Pavement widening and/or overlay scheme 25
- 1.6 Purpose – Bridge Surveys 25
 - 1.6.1 Introduction 25
 - 1.6.2 Scope 26
 - 1.6.3 Environmental Impact..... 26
 - 1.6.4 General requirements for bridge Site surveys..... 26
 - 1.6.5 Bridge widening surveys 31
 - 1.6.6 Railway overbridges 38
 - 1.6.7 For road overbridges 38
- 1.7 Purpose – Underground asset investigation..... 38
 - 1.7.1 Introduction 38
 - 1.7.2 Training and accreditation 39
 - 1.7.3 Locating methods 39
 - 1.7.4 Attribute Information 42
 - 1.7.5 Position quality level 43
- 2 Audit surveys 44**
- 2.1 Introduction 44
 - 2.1.1 Purpose 44
 - 2.1.2 Scope 44
- 2.2 Audit procedure..... 44
- 2.3 Pre-design surveys 45
 - 2.3.1 Audit level 1 45
 - 2.3.2 Audit level 2 46
 - 2.3.3 Audit level 3 49
 - 2.3.4 Audit level 4 50
- 2.4 Construction surveys 51
 - 2.4.1 Audit of project control stations 51
 - 2.4.2 Audit of work items 52
 - 2.4.3 Audit of earthwork volumes and stockpiles 54
 - 2.4.4 Audit of subgrade and pavement 55
 - 2.4.5 ‘As Constructed’ design plans 57
- 3 Aerial surveying 58**
- 3.1 Introduction 58
 - 3.1.1 Purpose 58
 - 3.1.2 Scope 58

3.1.3	<i>References</i>	58
3.1.4	<i>Air photo library</i>	58
3.1.5	<i>Geospatial technologies</i>	58
3.1.6	<i>Definitions</i>	59
3.2	Background	60
3.3	Aerial photography and products	61
3.4	Aerial photography	61
3.4.1	<i>Defining requirements</i>	61
3.4.2	<i>Purposes of aerial photography</i>	61
3.4.3	<i>Factors to be assessed</i>	62
3.4.4	<i>Aerial photography specifications</i>	62
3.4.5	<i>Project execution</i>	62
3.5	Digital imagery from aerial photography	65
3.5.1	<i>Defining requirements</i>	65
3.5.2	<i>Project execution</i>	67
3.6	Digital surveying data from photogrammetry	69
3.6.1	<i>Defining requirements</i>	69
3.6.2	<i>Project execution</i>	71
3.6.3	<i>Flight planning for photogrammetry</i>	72
3.6.4	<i>Targeting</i>	72
3.6.5	<i>Ground control</i>	76
3.6.6	<i>Photogrammetry</i>	81
3.6.7	<i>Field completion</i>	82
3.7	Existing products	83
3.7.1	<i>Aerial photography</i>	83
3.7.2	<i>Standard / topographic mapping</i>	83
3.7.3	<i>Cadastral mapping</i>	84
4	Cadastral surveys	85
4.1	Introduction	85
4.1.1	<i>Purpose</i>	85
4.1.2	<i>Scope</i>	85
4.1.3	<i>References</i>	85
4.1.4	<i>Definitions</i>	87
4.2	Cadastral surveys for the Department of Transport and Main Roads	88
4.2.1	<i>Acquisition of freehold land for roads</i>	88
4.2.2	<i>Acquisition of state land for roads</i>	91
4.2.3	<i>Cadastral surveys requiring special attention</i>	91
4.3	Survey brief	95
4.3.1	<i>General</i>	95
4.3.2	<i>Survey commencement</i>	95
4.3.3	<i>Survey completion</i>	95
5	GNSS survey control network	96
5.1	Introduction	96
5.1.1	<i>Purpose</i>	96
5.1.2	<i>Scope</i>	96
5.1.3	<i>References</i>	96
5.1.4	<i>Definitions</i>	96
5.1.5	<i>Acronyms</i>	97
5.2	General requirements	97
5.3	Connection to datum	97
5.4	Datum control	98

5.4.1	<i>Horizontal</i>	98
5.4.2	<i>Vertical</i>	98
5.5	Quantifying survey quality	98
5.5.1	<i>Uncertainty</i>	99
5.5.2	<i>Evaluating and expressing uncertainty</i>	99
5.5.3	<i>Survey control network uncertainty</i>	99
5.6	Field acquisition	99
5.6.1	<i>Equipment and Observation Technique</i>	100
5.6.2	<i>Network design</i>	100
5.6.3	<i>Observation records</i>	100
5.7	Processing and adjustment	101
5.8	Deliverables	101
6	Construction Surveys	102
6.1	Introduction	102
6.1.1	<i>Purpose</i>	102
6.1.2	<i>Scope</i>	102
6.2	Surveyor requirements	102
6.3	Equipment	102
6.3.1	<i>EDME and ancillary equipment</i>	102
6.3.2	<i>GNSS equipment</i>	102
6.4	Construction project survey control	103
6.4.1	<i>Survey mark protection</i>	103
6.4.2	<i>Survey control register</i>	103
6.5	Road Infrastructure Construction Survey	103
6.5.1	6.5.1 <i>Volume survey</i>	103
6.6	Bridge Construction Survey	105
6.6.1	<i>Introduction</i>	105
6.6.2	<i>Bridge design drawings</i>	105
6.6.3	<i>Bridge survey control</i>	106
6.6.4	<i>Bridge survey control network</i>	106
6.6.5	<i>Heights</i>	107
6.6.6	<i>Bridge coordinate system</i>	108
6.6.7	<i>Survey setout tolerances</i>	108
6.6.8	<i>Set out techniques</i>	108
6.6.9	<i>As Constructed Survey</i>	110
6.6.10	<i>Deliverables</i>	111
6.6.11	<i>Bridge Survey Control Accepted Practices</i>	111
6.7	Underground Assets	114
6.7.1	<i>Introduction</i>	114
6.7.2	<i>Training and accreditation</i>	114
6.7.3	<i>Setting out</i>	114
6.7.4	<i>Conformance (Quality Control)</i>	116
6.7.5	<i>As Constructed Surveyed</i>	117
6.7.6	<i>Abandoned and disused or retired underground services and assets left insitu</i>	118
6.7.7	<i>Certification requirement</i>	118
6.7.8	<i>Deliverables</i>	119

1 Ground and Feature Model surveys

1.1 Introduction

Ground and Feature Model surveys (GFM) are used for recording the current status of the physical world around us. GFMs define a project's topography (ground) and locate (model) those entities (features) which may influence a road infrastructure project. The particular features will depend on the purpose for which the geospatial information is to be used.

Part 1 – General Information of the *TMR Surveying Standards* contains general information that must be adhered to when undertaking a GFM survey. These include requirements regarding safety, environmental, datum and Surveyor qualifications. *Schedule 1 – Codes, Linestyles and Examples* details the departments' field codes, their linestyles and the models they belong to. Situational examples show where and how to use the field codes.

1.1.1 Purpose

The purpose of this document is to define the department's requirements for the provision of surveying services and products in relation to Ground and Feature Model survey projects for transport infrastructure purposes.

1.1.2 Surveyor qualifications

Persons undertaking GFM surveys for the department shall adhere to the requirements regarding qualifications, experience and accreditation as per Section 2.4.3 of *Part 1 – General Information*.

1.2 Overview

GFM projects can be initiated for a number of purposes. This GFM section is structured such that the general requirements for all GFM surveys are presented, followed by additional requirements for specific purposes (e.g. Bridge surveys).

GFM surveys can be used for many purposes, some of which are:

- concept planning for route selection
- preliminary design and option selection
- detail design
- progressive 'As Constructed' compliance checking during a project
- recording the final position of a constructed road infrastructure project and its ground surface interface
- asset capture and recording (including underground assets), and
- positional location, construction control and finished surface for maintenance projects.

The preceding list is by no means exhaustive and each purpose will have its own specific requirements on such things as accuracy, density of detail, feature set, cost, time, etc., so the requirements of a Ground and Feature Model survey undertaken for, or on behalf of, the department are multi-fold.

The overwhelming use of GFM surveys for the department is for detail design. These standards are developed to give the requirements for a GFM survey for detail design. If there is to be any change in the requirements for supply of survey information different to these standards, it must be detailed in the survey brief (project specification) and prominently noted in the corporate record.

1.2.1 Completeness of information

The Ground and Feature Model information for a roads infrastructure project is complex and varied. Parts of the information may be in hardcopy form only or in some proprietary format. While this information must be in a format usable by the department, it may not all be in the electronic project delivery file.

It may not be possible to reformat some data or to scan some documents to be included into the survey deliverables. Reference to any relevant information must be made within the project report and where applicable, within the digital data.

The Project Manager is to inform the customer that all information, including the extra information, is to be delivered to all on-users of the information.

1.3 GFM components

Ground and Feature Model information defines (models) the project topography (ground) and locates those entities (features) which may influence a road infrastructure project.

Despite this multitude of purpose and, potentially, multiple sources of information for a GFM project, a GFM survey essentially consists of four components:

1. Location – positional information to represent detail in its correct relative position.
2. Definition – accepted descriptive representation of the detail and its component attributes.
3. Presentation – present the collected detail in a format that is usable, understandable and unambiguous.
4. Quality – systematic methodology and auditing procedures to assure the integrity of the information.

These components exist in some form in all GFM projects.

1.3.1 Location

The locational component has three aspects:

1. Control location – to position and locate control from which the features and surface information to be located can be measured to the required positional accuracies.
2. Surface location – to define the existing shape of the ground surface upon which a road infrastructure project will be designed.
3. Feature location – to record the position and type of any existing features, manmade or natural, that could influence, or be reasonably expected to influence, the design of a road infrastructure project.

1.3.1.1 Control location

'Control' refers to the position of the stations from which the detail pick up will be made. It is the skeleton from which the detail is referenced to. The *Inter-governmental committee on Surveying and Mapping (ICSM) Standards and Practices for Control Surveys (SP1) Version 2.2* sets out standards of accuracy and provides recommended survey and reduction practices for control surveys.

a) Datum

Unless stated otherwise in the survey brief, datum for all Ground and Feature Model surveys is to be as per Section 5 of *Part 1 – General Information*. Datum in Queensland is referenced by Permanent Survey Mark's (PSM) in DoR's Survey Datum Control database (SCDB) which are readily available in the Queensland Globe.

b) Datum Control

To rigorously propagate datum to the project survey control, direct measurements to the datum control survey mark network are required. Datum Control marks of sufficient quality within the SCDB of PSMs administered by DoR shall be the datum (origin) of the project survey control.

Horizontal

Registered PSM's used as Datum Control to derive horizontal coordinates of the survey control network shall have a Horizontal Positional Uncertainty (PU) of < 0.020 m. A hierarchical system shall be used when selecting Datum Control PSM's based on GDA2020 horizontal uncertainty, suitability and stability of the mark. Distance from the project Site is also an important consideration. In descending order of desirability:

- Tier 1 and 2 Continuously Operating Reference Stations (CORS) with Regulation 13 certificate
- Tier 3 Continuously Operating Reference Stations (CORS)
- QLD ANJ adjustment PSM's with PU < 0.020 m
- PSM's with PU < 0.020 m

Vertical

A hierarchical system shall be used when selecting PSM's to derive the height of project survey control. The system is based on GDA2020 ellipsoidal vertical positional uncertainty, AHD quality, and stability of the mark. Distance from the project Site is also an important consideration.

- QLD ANJ adjustment PSM's with Ellipsoidal PU < 0.050 m & AHD 3rd Order Class C quality
- AHD 3rd Order Class C uncertainty PSM's
- QLD ANJ adjustment PSM's with Ellipsoidal PU < 0.050 m & AHD 4th Order (minimum Class D) quality
- AHD 4th Order (minimum Class D) quality PSM's

c) Quantifying survey quality

The *ICSM Standard for the Australian Survey Control Network – SP1 v2.2* (or its successor) is to be used as the basis as to the minimum requirements for determining position and associated uncertainty for primary control location. *SP1 v2.2* completes the transition from CLASS and ORDER to uncertainty as the basis for evaluating and expressing the quality of measurements and positions.

The purpose of the SP1 standard is “to specify the minimum requirements for the determination of one, two, or three dimensional position and associated uncertainty of Australia’s survey control marks”.

SP1 states:

“The quality of a control survey shall be quantified in terms of uncertainty. When quantifying survey quality, the following uncertainty categories shall apply:

Survey Uncertainty (SU) is the uncertainty of the horizontal and/or vertical coordinates of a survey control mark relative to the survey in which it was observed and is free from the influence of any imprecision or inaccuracy in the underlying datum realisation. Therefore, SU reflects only the uncertainty resulting from survey measurements, measurement precisions, network geometry and the choice of constraint. A minimally constrained least squares adjustment is the preferred and most rigorous way to estimate and test SU. SU is expressed in SI units at the 95% confidence level.

Positional Uncertainty (PU) is the uncertainty of the horizontal and/or vertical coordinates of a survey control mark with respect to the defined datum and represents the combined uncertainty of the existing datum realisation and the new control survey. That is, PU includes SU as well as the uncertainty of the existing survey control marks to which a new control survey is connected. A fully constrained least squares adjustment is the preferred and most rigorous way to estimate and test PU. PU is expressed in SI units at the 95% confidence level.

Relative Uncertainty (RU) is the uncertainty between the horizontal and/or vertical coordinates of any two survey control marks. Such marks may be connected by measurement directly or indirectly. The preferred and most rigorous means for deriving RU between pairs of marks is by propagating the respective variances and co-variances obtained from a minimally or fully constrained least squares adjustment (i.e. from SU or PU). RU can be expressed in SI units at the 95% confidence level, or in a proportional form such as a ratio of uncertainty per unit length or survey misclosure.”

d) Evaluating and expressing uncertainty

- SU shall be estimated and tested using a minimally constrained least squares adjustment.
- PU shall be estimated and tested by way of a fully constrained least squares adjustment.
- RU may be estimated and tested by way of a fully constrained least squares adjustment or linear misclose ratio.
- SU, PU and RU of Survey Control shall be expressed in terms of a horizontal circular confidence region at the 95% confidence interval.

e) Primary control

Primary control marks establish the project survey control network. Primary control marks shall be placed in positions clear of likely short term Works, such as periodic maintenance, where they will remain undisturbed for future use. Primary control marks shall generally be Permanent Survey Marks. Primary control is to be at approximately 1 km intervals through the project unless stated otherwise in the survey brief. A minimum of three primary control marks are to be coordinated for every project. Ideally they should be positioned such that they encompass the project and allow the main traverse to start and end on a primary control mark.

The PU of the primary control marks is to be < 0.030 m. When using existing permanent marks from the Survey Control Data Base (SCDB), they must conform to this PU. If there are insufficient existing marks, then extra marks shall be placed and positioned to this PU. The department is obliged to help strengthen the local survey and mapping infrastructure by strengthening the geodetic network where possible. All GNSS observations used to coordinate any marks are to be supplied to the department for later submission to DoR. GNSS networks to coordinate primary control marks are to have a Survey Uncertainty of < 0.015 m. Refer Section 5 of this document for additional information on coordinating primary control using GNSS networks.

f) Secondary control

Secondary control shall consist of survey marks placed by traversing between primary control marks to achieve an RU < 0.010 m on individual marks and/or an RU < 30 ppm (linear misclose ratio) on the traverse. Along with the primary control these survey marks will then be used to locate data for the ground and feature model survey.

g) Traversing

The method of traversing secondary control marks must achieve the required accuracies. Traverse method shall, as a minimum, conform to the following requirements:

- Number of angular rounds face left/face right : 3
- Residual from mean angle within the set (should not exceed) : 10 seconds
- Reciprocal distance measurements : yes
- Difference between reciprocal horizontal distances : less than 6 mm

The distance between traverse stations should not be greater than 250 m and shall not be greater than 300 metres.

Independent observations of angles when compared to the mean traverse angle, the difference shall not exceed 10 seconds of arc. Observation discrepancies outside this tolerance range must be resolved.

Observed distances to coordinated primary control, secondary control and side traverse stations are to agree within $(5 + 0.01*d)$ mm where d is the measured distance (in metres). Observation discrepancies outside this tolerance range must be resolved.

All raw angle and distance observations and calculations must appear in the project record. The final (adjusted) traverse bearing and distances must appear as annotation on the traverse line in project plots.

h) Levelling

An automatic or electronic level shall be used to obtain the height of any and all primary control, secondary control, side traverse stations, BMs, Permanent Survey Marks, reference marks and instrument stations. The project height values for all survey marks shall be determined from the average of two-way independent differential level runs referenced to the project height datum mark.

The Surveyor's field notes shall contain full levelling details, Datum used and all calculations of levels. Only the survey brief may alter these requirements. Where a secondary height datum mark is available, it must be observed in order to verify the value of the primary mark. The survey brief may require the misclosure to be adjusted out.

The maximum allowable misclose (in millimetres) as determined from the reciprocal level runs must not be greater than $12 \text{ mm} * \sqrt{k}$, where 'k' is the distance in kilometres from the datum mark (refer Section 4 of the *Guideline for Control Surveys by Differential Levelling, Special Publication 1 version 2.2 (ICSM)*).

i) Survey marks

Survey marks are to be of the types as prescribed in Section 6 of *Part 1 – General Information* requirements. In urban areas, particular attention should be paid to the visual pollution caused by using paint marks as finders on roads, footpaths and fences. Discrete, unobtrusive marking is to be used.

The type of survey mark placed must be annotated to the digital record of the mark, along with the identification descriptor of the mark.

Traverse stations

All deflections in the survey traverse lines are to be regarded as traverse stations and annotated accordingly. The distance between traverse stations should not be greater than 250 m and shall not be greater than 300 metres.

All Permanent Survey Marks or Bench Marks that are within the project site or are in line-of-sight from a traverse station are to be referenced. They may be substituted for a traverse station reference mark (excluding primary control marks).

Instrument stations

Instrument stations are referred to as those points occupied by a survey instrument, temporarily required for the location of feature and surface information that cannot be located from the traverse stations. Marking of these stations generally follows the requirements of traverse stations.

Reference marks

Reference marks, as a minimum, shall be placed every 500 m. They will be directly connected to a primary or secondary control mark.

Reference marks should be placed in positions clear of likely short term Works, such as periodic maintenance, where they will remain undisturbed for future use and must be placed in such a manner as to allow the accuracy on the mark to be meet the requirements of *Section 1.3.1.4* for survey marks. Should traverse stations be destroyed, reference marks may be used to allow additional work to be carried out in a sub-section of the project or to be used as quality checks when re-establishing secondary control from the primary control marks.

The type of mark placed should conform to the general requirement for survey marks and shall be marked with its unique point identifier as identified in the digital data. Primary control marks may not be used as reference marks. Permanent Survey Marks and Bench Marks that are not primary control marks, may be used in lieu of dedicated reference marks. Suitable cadastral marks (e.g. screw in concrete) may be substituted as a reference mark. Pegs, including dumpy or cadastral pegs, are not to be used as reference marks.

Side traverses

If subsidiary traverse lines are needed to extend survey information away from the main traverse line, such as alongside streets, the subsidiary traverse will be marked as for the primary traverse stations. Side traverses over 500 m long or featuring more than two stations, that will be used to locate hard surfaces; services; or structures, shall either connect back to the main traverse or end on and be adjusted to a primary control mark.

All minor side traverses, that will be used to locate terrain only (e.g. gully traverses), should connect back to the main traverse or be verified by alternate means at least every 500 m (e.g. RTK control point).

Permanent Survey Marks and Bench Marks

Where Permanent Survey Marks (PSMs) and Bench Marks (BMs) are established they must conform to the types described in Section 6.5 of *Part 1 – General Information*. PSMs should be placed in preference to BMs. Bench Marks may be placed when it's not practical or useful to place a PSM. This may be because a sufficient number of high quality PSMs exist in the area or the mark will be of limited value past the construction phase.

They are to be established in safe positions, clear of any proposed Works:

- at approximately one kilometre intervals along the survey
- at either end of a proposed major structure, provided no other Bench Mark or Permanent Survey Mark exists or has been established within 100 metres (excluding marks on existing bridges)
- at the start and end of each survey, provided that no other Bench Mark or Permanent Survey Mark exists within 300 metres, and
- at any other position as the brief defines – for example, the junction of two roads.

Additional survey control information

Any observations or calculations that verify the survey, such as:

- individual angular observations used to determine the traverse bearings, and
- distance measurements from which the length of the traverse line was determined.

should be included in the project delivery (scan document / sketch if necessary).

In order to verify the accuracy of the instrument height during feature and terrain pickup, each time a station is occupied, connections must be made to at least three marks, whose heights have been determined from independent level runs. These marks should be placed such that one is adjacent to the instrument station and the other two are approximately half the distance to the approach station and the departure station.

Note that when locating the ground and feature model, the lengths of the radiated lines must be limited to achieve the required accuracy.

1.3.1.2 Surface location

The ground surface is to be defined by a series of barrier / breakline strings and spot heights. Note that when locating the ground surface, the lengths of the radiated lines must be limited to achieve the required accuracy. These lines and points are used to force the production of the final triangulation mesh, called a 'Triangular Irregular Network' (TIN). This TIN approximates the ground surface.

a) Barrier / breakline strings

Barrier / breakline strings represent a crease or fold in the ground surface. As such, they form a line across which it's invalid to interpolate heights. Similarly, breaklines cannot cross except if they cross at a co-incident point that shares the same positional horizontal and vertical co-ordinates. Barrier lines must form the edges of triangles in the TIN.

Some features by their very nature have a barrier attribute associated with them. Such features as tops or bottoms of banks, drains, kerb lines, shoulder of roads or top and bottom of retaining walls have this intrinsic barrier associated with the feature. The department has decreed that some features, while they are not intrinsically breaklines, are often associated with barrier lines and, as such, they have the barrier attribute affixed to the feature. Examples include edge of driveways, edge of water and edge of footpath.

The current coding and mapping system in *Schedule 1 – Codes, Linestyles and Examples* will give the model to which these codes will be placed. It should be noted that codes may NOT be moved from the standard models as listed.

b) Terrain model

The department requires a dedicated terrain model to represent the ground surface. This model is to contain only barrier / breakline strings, as well as spot heights. Together, these codes comprise the only information that is to be used to create the TIN, which represents the ground surface.

The terrain model must be capable of re-creating the TIN directly from the survey information supplied. There is to be no interactive editing of the triangles to produce the TIN. No interactively edited or additional information will be accepted for the creation of the TIN other than a trimming boundary, which is to be used to delete unwanted triangles.

Triangle trimming

Unwanted additional and potentially erroneous triangulation, such as along the edges of the data or in areas of invalid survey detail, is to be deleted.

Survey boundary

A closed polygon survey boundary string is to be created around the outer extents of the ground surface data to limit and define the terrain model. Each and every point on the polygon, must be a copy, at an identical horizontal and vertical position of a ground surface point or point on a string contained within the terrain model. This survey boundary string may be used to limit the triangulation from creating erroneous or sliver triangles on the extents of the survey. The triangulation shall fill to the survey boundary string but not past it.

Survey boundaries may also be created internal to the survey to highlight and limit triangulation of areas with insufficient or no ground surface data (e.g. an unsurveyed lake).

The survey boundary string(s) are to be created and supplied by the Surveyor that performed the field survey in the case of ground survey or the photogrammetrist in the case of aerial photography.

Transfer of surface information

The ground surface information is transferred to users by giving them the barrier / breakline strings, along with the spot heights to allow users to reproduce the triangulation in their own processing package.

The barrier / breakline features and spot heights shall be the only form of definition of the ground surface acceptable to the department. Therefore, all discrete points appearing in the survey data must be located and recorded in the field to accurately represent the ground surface. The control of the triangular mesh, by interactive means, in order to achieve a desired result, is unacceptable to the department.

Remedial work

If, upon processing of the field data, it is noticed that there is an error in the representation of the ground surface, or that there is an omission of survey information in the definition of the ground surface, then additional field survey is required to correct the deficiency.

Under no circumstance is the Surveyor to alter the breakline attribute of a feature to achieve a non-standard outcome. Doing so will affect the integrity of the terrain data when transferred to other design systems.

1.3.1.3 Feature location

All observable features, either natural or artificial, on the ground surface or above ground that could, or may be reasonably thought to, influence a transport infrastructure project are to be located. All surface outcrops of sub-surface features are also to be located. It may be that for a particular survey project only a sub-set of the features is needed. This will be stated in the survey brief and is the only method of restricting the feature location. Some projects may require sub-surface features to be located, requiring exposure of the features by 'pot holing' or some sort of electronic locators. If so, this will be mentioned in the survey brief and the method of collection must be noted with the feature in the project records.

Relative accuracy

The located points which make up the breaklines, spot heights and detail features are to be located to an accuracy commensurate with that specified in Section 1.3.1.4 of this document. When locating features, the lengths of the radiated lines must be limited to achieve the required accuracy.

1.3.1.4 Accuracies

Accuracies will be stated in terms of 'relative uncertainty (RU)'. This is the average measure, in millimetres, at the 95% confidence level, of the relative uncertainty of the co-ordinates, or height, of a point(s), with respect to adjacent survey control marks. This can be thought of as the allowable semi-major axis of the standard error ellipse with respect to the known control station.

a) Position

The plan position of 95% of all independently measured points, when compared with their values determined from the detail model, must be not greater than that shown in the following table.

Table 1.3.1.4(a) – Position relative uncertainty

Description	Relative uncertainty (m)
Pavement	0.025
Service utilities	0.025
Structures	0.010
Survey marks	0.010
Other	0.050

b) Heights

For 95% of all discrete feature detail points, the difference between their model value and an independently levelled value, must not be greater than shown in the following table.

Table 1.3.1.4(b) – Height relative uncertainty

Description	Relative uncertainty (m)
Pavement (full construction)	0.020
Pavement (widening / overlay)	0.010
Other hard surfaces	0.025
Service utilities	0.025
Structures	0.010
Survey marks	0.010
Other	0.050

Differential levelling shall be used to obtain the height of all instrument stations. Heights shall be calculated from the mean of two-way independent flights of levels connected to Project Control Marks. The Surveyor's field notes shall contain full levelling details, Datum used and all calculations for instrument station heights.

In order to verify the accuracy of the instrument height, each time a station is occupied, connections must be made to at least three marks whose heights have been determined from the independent level runs. These marks should be placed such that one is adjacent to the instrument station and the other two are approximately half the distance to the approach station and the departure station.

Note that when locating detail, the lengths of the radiated lines to the feature detail must be limited to achieve the required project accuracy.

c) Interpolated heights

The difference between a terrain point's interpolated height, as determined from the triangulation mesh, and its independently levelled value, must not be greater than that shown in the following table.

Table 1.3.1.4(c) – Interpolated height relative uncertainty

Description	Relative uncertainty (m)
Pavement (full construction)	0.040
Pavement (widening / overlay)	0.020
Other hard surfaces	0.050
Natural surfaces	0.100
Drainage	0.100
Other	0.100

d) Triangulation dimensions

Irrespective of the requirements in Table 1.3.1.4(c), no triangle side shall have a length greater than 25 metres on the pavement and 50 metres elsewhere in the project area.

1.3.2 Definition

All entities located in a geospatial project are identified by a shorthand code to facilitate field entry of the information into the project. Each entity is recorded with its relative geographical position and annotated with varying numbers of attributes, depending on the type of entity, which describe the entity and its condition. These entity codes can be of several types: a point, a line or some text. To provide a clear understanding of the entities located in the project, *Schedule 1 – Codes, Linestyles and Examples* presents a listing of the Codes, what they represent, how they are presented in the project and to which Model they are placed.

Linear features must be strung as a Line String, which must contain at least two points on each string. If a feature is represented in *Schedule 1 – Codes, Linestyles and Examples* as a symbol located only at one point, then it must be located as a single point string, even if it represents a two-dimensional entity. The use of linear codes on point features will cause errors in string based design systems.

The Surveyors processing of the project will ensure that there are only valid codes in each model. If a non-standard code is used, it will be mapped to 'Survey Unknown Feature' Model or 'Survey Unknown Comment' Model.

If there is no appropriate code for an entity, then it must be coded as a Non-Standard Feature String if a line type or a Non-Standard Feature Point if a point type. The entity must be annotated with a description of its nonconformance.

1.3.2.1 Feature coding

The department regards the use of its standard feature coding as mandatory. A copy of the coding has been included in *Schedule 1 – Codes, Linestyles and Examples*. The coding has been specifically designed to provide a representation of the information required for design purposes, as well as providing some flexibility for the Surveyor. As the Surveyor's responsibility does not include the final plan presentation, the cartographic quality of the symbols and linestyles has been designed for verification purposes only. Under no circumstances should the Surveyor alter the attributes of feature definition.

All feature coding, used in conjunction with a survey project must be in accordance with the department's current standards as set out in *Schedule 1 – Codes, Linestyles and Examples*.

Information supplied that does not conform to this standard will be deemed not to meet the Specifications and payment will not be made until the standard coding is adopted.

1.3.2.2 Street and traffic lights

For street and traffic lights without mast arms, the pole supporting the light is to be located. Where the traffic light or street light is attached to a mast arm, the actual plan position of the traffic light pivot or street light head must be located and a feature shown attaching the light to the pole.

1.3.2.3 Traffic and advertising signs

For signs on single supporting poles, the pole is to be located and attributed with the details of the sign. This may also include dimensions and orientation if required by the survey brief. For signs on two or more supporting poles, the bottom edge extremities of the sign must be located.

If the sign message is abbreviated in digital data, a list of abbreviations must be provided in the deliverables. If the wording on the sign, such as directional signs, is too verbose to include in the comments, then the details must appear in the survey book. Alternatively, photographs may be included in the survey book and referenced to the point number.

1.3.2.4 Line marking

Line marking is especially important in urban areas and at intersections. Specific codes for various linemarking patterns have been included in the code library. Therefore, it is not necessary to locate each individual line in a broken line pattern. In areas of detailed linemarking, the details must be included in the sketch.

As linemarking may not always be coincident with terrain features that must be represented by barrier strings, they have not been given a barrier string status in the code library and therefore must be regarded as feature information only. Where linemarking follows a road crown, additional points must be located, using the correct feature code, that represent the three dimensional terrain feature. Only those points that represent the planimetric position of the line marking need to be located.

1.3.2.5 Utility services

Unless otherwise specified in the survey brief, the Surveyor is to locate only the 'at ground' indication of underground services. If the service is exposed, however, its position and level must be recorded, along with the type and physical construction of the service. 'At ground' indicators include, but are not restricted to, manholes, inspection boxes, valves, telecommunication markers, etc.

If required by the brief, the service joining these 'at ground' indications must be included in the digital data, as well as shown in the detail sketches. This information is available from the relevant authority and their assistance should be sought in locating the service within the area of interest.

Small inspection boxes and manholes, that have standard dimensions, are located by the centre point and can be referenced in both the digital data and the sketches as a 'standard type' as long as the dimensions and 'standard type' classification are shown in the Survey Book.

Also refer to Section 1.7 of this document.

1.3.2.6 Kerb and channel

The controlling parts of the kerb and channel feature are the channel lip and the back-top of the kerb. These orient the feature. The lip also determines the pavement crossfall. String codes are included in the *Schedule 1 – Codes, Linestyles and Examples* to cover kerb and channel definition. The component features of kerb and channel structures are:

- channel lip
- channel invert
- kerb top at face, and
- kerb top at back.

The manner in which these strings are generally used, as well as situations such as where overlay bitumen has been placed proud of the kerb and channel, or where bitumen has 'built up' and spilled over the lip, has been set out in *Schedule 1 – Codes, Linestyles and Examples*.

1.3.2.7 Drainage structure

For small drainage structures, such as gully pits and field inlets, a single point will locate the feature. If possible, the invert level of the structure should be included in the digital data, otherwise its depth must be included as annotation to the point. If the structure is complex or of a non-standard type, e.g., cast insitu, then a sketch showing relevant dimensions is required within the Survey Book.

Cross pavement

Drainage structures need to be surveyed to provide a plot of the feature showing its general location, its components and their extremities in the detail model. The invert level of the structure must be included in the digital data. An invert level is required for each individual cell of a multi-celled structure.

The Surveyor will annotate each structure. This annotation will include:

- size (internal) of the structure
- structure type
- subjective rating from Table 1.3.2.7
- descriptive comment, and
- e.g. 1200CCMC poor sagging ponding.

Structures size should be carefully measured and, where appropriate, standard structure sizes referred to. Care should be taken measuring older pre-metric structures to not make the size 'fit' current standards.

Typical types of culverts and their abbreviations are:

- Reinforced Concrete Pipe – RCP.
- Reinforced Concrete Box Culvert – RCBC.
- Reinforced Concrete Culvert (cast insitu) – RCC.
- Slab Link Box Culvert – SLBC.
- Circular Corrugated Metal Culvert – CCMC.

Table 1.3.2.7 – Subjective Rating

Condition state	Subjective rating	Description
1	Good (‘as new’)	Free of defects with little or no deterioration.
2	Fair	Free of defects affecting structural performance, integrity and durability. Deterioration of a minor nature in the protective coating and/or parent material is evident.
3	Poor (monitoring required)	Defects affecting the durability / serviceability which may require monitoring and/or remedial action or inspection by a structural engineer. Component or element shows marked and advancing deterioration including loss of protective coating and minor loss of section from the parent material is evident. Intervention is normally required.

Some particular items to look for and comment upon are:

- culvert condition – cracking, rusted out and so on
- standing water issues – is water ponding anywhere in the culvert?
- sagging – is the culvert sagging at any point?
- deformation – is the culvert squashing out of circular shape?
- percentage of silting.

The area around the drainage structure must be located in sufficient detail to ensure the terrain model and resultant triangulation are a true representation of the terrain. For culverts this will include, but is not limited to, the location of the culvert headwall and wingwalls or extent of stone pitching. This is important as the subsequent design may require the extension of the structure. In this case, the designer must be able to extract a section through the structure in order to determine any restriction to the extension.

Stream and embankment details may be required to provide sufficient information to enable the hydraulic and environmental considerations to be accurately addressed.

Photographs shall be taken of drainage structures and their surrounds that show the condition of these structures in terms of the hydraulic capacity and structural strength. Photographs should be taken of any relevant feature, like deterioration or deformation, which will help clarify the condition of the structure.

Stormwater manholes

The centre of the stormwater manhole lid is required as the controlling point for the feature. Additional details, such as depths, invert levels, the extents of the underground chamber, may be required by the survey brief. Invert levels must appear in the digital information while the remaining information can be shown in a sketch.

In addition to the drainage structure requirements above, surveys for lining circular corrugated metal culverts have additional requirements.

Culvert Geometry for Lining Circular Corrugated Metal Culverts (CCMC)

When rehabilitation of a culvert is being considered, accurate assessment of the geometry of the existing culvert is essential to determine the finished geometry of any liners prior to construction to confirm the hydraulics of the culvert.

Where liner diameter must be set before construction, the survey must be of sufficient detail and accuracy to determine the largest diameter straight cylinder than can be inserted in the culvert at an appropriate grade. Culvert ring cross-sections at centres of less than two metres with a minimum of eight points per cross-section are required. The survey should include bevel ends and deliberately target points observed to potentially encroach on the diameter of the relining cylinder (e.g., bulges, bolts). If the CCMC has invert protection in the form of a concrete liner, it must be accurately located.

Additional minimum survey requirements are:

- the survey shall include the road surface for a minimum of 20 m on either side of the culvert, with sufficient information to identify the minimum cover to each barrel
- the geometry of any headwalls, including wingwalls and other hydraulic features, are to be included in the survey
- the details of the current culvert: profile of corrugations (pitch and height), wall thickness
- confirmation that the culvert has not been previously relined
- details of aprons and cut-off walls, and
- voids behind culvert walls should be located where possible (i.e., dips / depressions in the road above the culvert, sink holes and wash outs in the embankment).

1.3.2.8 Subsidiary information outside the GFM

Additional information outside the GFM area may need to be collected. This will apply particularly to areas where the survey crosses any watercourse. Where a bridge Site is proposed, the requirements are set out in Section 1.6 of this document. Unless instructed otherwise by the survey brief, the following information is required for all other watercourses.

Bed profile levels

At watercourses, sufficient bed levels are to be obtained for at least 100 m, or until a height difference of at least 0.3 m is obtained, both upstream and downstream, to determine the average bed gradient. This information is additional to the recorded information to define the terrain area for the project. It is to be recorded using the appropriate stream codes from *Schedule 1 – Codes, Linestyles and Examples*. These strings will use the same macro and have the same feature function as the Terrain strings, but will not be included in the Terrain area for triangulation purposes. Irrespective of the fact that the drain codes are used in the Terrain area to define the bed for contouring purposes, the stream gradient codes should still commence at the survey centreline and not the boundary of the Terrain area. This may entail the stream gradient codes being dual coded with the Terrain codes within the Terrain area.

Locations of the banks are also to be recorded at least 100 m upstream and downstream from the proposed centreline of aboveground structures or from culvert inverts. This information is to be coded as per the relevant code list in *Schedule 1 – Codes, Linestyles and Examples*. These strings also will use the same macro and have the same feature function as the normal codes for banks, except that they will not be included in the triangulation to define the Terrain area. The standard terrain codes will still be used to define the banks within the confines of the GFM's Terrain area and unlike the stream gradient strings, these non-terrain bank codes will simply be an extension of the terrain bank codes outside the Terrain area. There is no requirement for these strings to be dual-coded.

These bank traverses are to include the location of any scouring or tributaries of the main stream, as well as any anabranches and flood channels entering or leaving the main stream.

Where the terrain precludes the use of Electronic Distance Measurement Equipment (EDME), this information may be collected by other survey methods with the requirement that the information must be entered into the digital data by the Surveyor.

The information may also be obtained by using GNSS of a suitable standard of accuracy; however, it is the Surveyor's responsibility to ensure the data is entered with the other digital data for the survey in a format suitable to the Project Manager.

Particularly for streams where it is difficult to determine the direction of flow from the contours, it will be necessary to define this direction of flow. This may occur where there is a series of waterholes or where deposits of sand or gravel make it difficult to determine the direction from the averaged bed gradient. The use of the stream gradient codes provides the means of indicating the direction of flow, in the same manner as the Terrain codes for drains.

Cross-sections

In addition to the bed levels, cross-sections from bank to bank are to be taken at the end of both the upstream and downstream level run. As well as these, cross-sections should be taken where there is a marked change in the shape of the watercourse and at the point where it is most restricted. These cross-sections are to be recorded using the Stream string codes.

1.3.2.9 Buildings and property accesses

If required, buildings must have both their face and eaves or awnings located. The type of construction material used for the building, its eaves or awnings can be included in the digital information or as a noting in the sketch. It must, however, appear in at least one form. The condition of the building must appear in the sketch.

Property accesses, either pedestrian or vehicular, must be identified and located. Sufficient level information must also be recorded in the vicinity, so that a cross section from any proposed roadworks, through the access, can be determined.

The type of construction material and the width of the access must also be included in either the sketch or the digital information.

1.3.2.10 Cadastral information

Cadastral connections

Connections between the survey traverse and cadastral marks, which can be readily identified on the Registered Plans, are to be made so that the boundary information can be accurately related to the survey.

Where several cadastral plans are on a common datum, and connections exist between each plan, sufficient connections to the cadastral marks need only be made to provide a correlation between the plans and the survey traverse.

Where no correlation exists between adjacent cadastral plans, at least two connections to cadastral marks on each plan are required, so that a correlation can be accurately established.

The connection information is to be included in the digital data so that the position of the mark appears on a plot of the information.

The Registered Plan number, the type of mark connected to and the plan station number are to be included in the sketch in the field notes.

Boundary information

The property boundaries, as shown on the Registered Plans, are to be included in the digital data under the appropriate code if required by the survey brief.

Where an accurate model of the boundaries is required, it will be necessary to manually input the boundary information from the cadastral plans into a co-ordinate geometry package. The information must be on the same co-ordinate datum and azimuth of the survey adjusted so that the cadastral information is consistent with the property corners located in the survey. Construction lines, such as secants and road connections, are not to be included in the data.

All internal property side boundary information is to be included for a distance of at least 20 metres. Boundary information adjacent to side roads and turnouts is to extend a distance at least equal that of the detail information.

1.3.2.11 Digital cadastral data base (DCDB)

Where boundaries are only required for planning or display purposes, Digital Cadastral Data Base (DCDB) information purchased from the Department of Resources (DoR) may be used to provide the boundary information as an overlay to the feature and terrain information.

The relevant areas should be excised from the DCDB data. Care must be exercised when using cadastral information extracted from the DCDB. The DCDB was generated by digitising the best available maps covering the area and this procedure has led to large errors within the data with errors of more than 5-20 metres being common. For this reason, the information should be only used for providing general information and not for accurately locating property boundaries for land acquisition purposes.

DCDB licensing conditions

The cadastral boundary information is derived from DoR's Digital Cadastral Data Base (DCDB). Ownership and copyright of the data remains with DoR. The department purchases the data from DoR on the basis that the DCDB data will only be used within the department or by consultants working directly for the department. If required, a Memorandum of Understanding between the department and the consultant must be completed before the consultant receives any DCDB data in either an enhanced or unenhanced form. Geospatial Technologies can provide a sample Memorandum of Understanding on request.

Should third parties who are not consulting to the department request DCDB data from the department, they are to be denied access to the data until a separate application is made to DoR. Geospatial Technologies can assist in this process. The department must also make a separate application to DoR if it wishes to sell hard copy enhanced or unenhanced DCDB data. The department must also comply with the *Queensland Land Information System (QLIS) Guidelines for the 'Provision of Land-Related Data for Non Commercial Purposes'*.

1.3.3 Presentation

1.3.3.1 Deliverables

Information supplied by the Surveyor is to be sufficiently comprehensive so as to provide complete details of all features, whether natural or manmade, which are likely to influence the location, design or construction of the proposed infrastructure or to define the infrastructure itself.

Information is to be supplied in the forms of:

1. electronic survey information in the required format as per Section 1.3.3.3 (a)
2. verification plots of the electronic information
3. survey book, including survey notes / sketches / plots
4. signed survey report, and
5. digital report files.

This data may be provided in the format as used in the electronic survey book developed by the department.

a) Survey book

Departmentally approved survey books will be used to record all the detailed feature sketching / plots and levelling information unless instructed otherwise by the survey brief.

The survey books must be completed on delivery of the project. The Surveyor must sign the certificate taking responsibility for the information and ensure that the remainder of the books, including the covers, are also completed.

b) Detail

The Survey notes / sketches / plots shall contain, but not be limited to, the following information:

- Survey control

A sketch / plot of the Survey Control, including the primary and secondary control, is to be provided. The original survey marks used to instantiate the Datum (both horizontal and vertical) and the Projection must be prominently displayed in the sketch / plot. If the project is an extension of another survey, the marks used from the original survey must be cross-referenced to the original field books or origin of information.

- Survey chainage datum

Where possible, the gazettal chainage of the start point of the survey is to provide the survey chainage datum and a sketch / plot showing the manner in which this was established is to be provided.

- Traverse location

A sketch / plot of the traverse location showing the survey stations and the marks placed along the traverse. The sketch is also to include the station number used in the digital information and a description of the mark placed at the station

- Coordinate table

Table of the final adopted co-ordinate value of the marks placed.

- Recovery marks

Recovery marks must be shown in the field notes in relation to their respective survey stations.

- Traverse bearings and distances

Each traverse line in the sketch / plot must be annotated with its final bearing and horizontal distance between traverse stations. Any observations or calculations that verify the survey, such as individual angular observations used to determine the traverse bearings and distance measurements from which the length of the traverse line was determined should be included with the field notes, in a position that does not interfere with the detail sketching or the display of other information.

- Permanent Survey Marks

PSM Form 6 and CORS Regulation 13 certificates for all marks connected to shall be included in the survey book.

- Detail plots

The field notes are to include a sketch / plot of the feature information to a degree necessary to assist the designers in visualising the project area sufficiently to aid in the design process. This information will augment the digital data, which will include the actual three-dimensional position of the feature or boundary of the area of concern. In some instances, the information will appear in both the digital data, as well as the sketch / plot; however, the information must be included in at least one form. If standard object types are used in the description of detail, such as kerb type 'A', then the standard dimensions of the object, as well as the point located, must be defined in the Survey Book.

For design office purposes, the sketch / plot will include:

- descriptions of various types of timber, soil and vegetation
- descriptions of rock, its type and condition
- a description of any drainage structure, its opening dimensions and current condition in terms of hydraulic capacity and structural strength
- the details of any ponding, flooding and periods of inundation. This information may also require an additional report to include information gathered from owners and occupiers of the properties affected by the flooding, etc.
- details of land usage, including the types of crops, access to, from and across the proposed road, watering facilities and any other features, relevant to the working property, that are liable to be affected by the proposed road

- the construction material and general condition of both external and internal fences
- other construction material and general condition of any buildings or manmade structures
- the general condition and surface material of any road or track
- descriptions, where known, of any public service utilities, including the unit's service number
- for power poles and other aerial service utilities, the pole number and number of wires attached to the pole
- the actual lettering shown on street and traffic signage
- the type of construction material of any property accesses
- property descriptions, including Lot on Plan numbers
- the identification and type of any survey mark located, including its cross-reference to the originating document. In the cases of BMs, the marked chainage and the authority that placed the mark. For Permanent Survey Marks, the mark number.
- the identification and origin of any cadastral survey mark located
- the position and type of mark placed for recovery purposes
- should the sketch not flow to the following or previous page, then that page must be cross referenced to its adjoining sketch page.

For the Surveyors purposes this sketch / plot will include:

- the name and number of all linear strings used, annotated at least once on each page, as well as at the start and end of each string
- the position of major feature information, such as large manholes or survey marks, so that the sketch may be easily orientated.

c) Height information

- Datum

For the height datum, the mark used must be annotated 'Height Datum' and include its origin and adopted height value and cross referenced to the originating document.

- Height information

The height information must contain the observations recorded in the determination of the survey control, BM and Permanent Survey Mark heights.

An automatic or electronic level shall be used to obtain the height of survey control (including nominated instrument stations), BMs and Permanent Survey Marks. The Surveyor's field notes shall contain full levelling details, Datum used, comparisons to current height value and all calculations for instrument station heights.

If the height information has been determined by the use of an electronic level capable of storing the staff observations in a digital file, then a copy of that file must be delivered in lieu of the standard level field notes.

d) Additional survey control information

- completed Form 6's of new Permanent Survey Marks
- maintenance forms for existing Permanent Survey Marks found, not found or found to be damaged

1.3.3.2 Verification plots

In order to provide an immediate verification of the survey information, the Surveyor must provide a verification plot or series of verification plots at a scale nominated in the brief. Such plot sheets must carry the name of the job, the sheet number in the sequence of sheets, the responsible Surveyor and the statement that 'the information contained in this plot has been verified free of error' and signed by the person who performed that survey and the Surveyor who accepts responsibility for all work performed.

Such plot/s are to show all information located in the survey, as well as any additional information added to the model subsequent to the survey. Contour information, generated from the field information, must also be shown on the verification plots.

All feature information shall be shown in the department's standard linestyles and symbol types as provided in *Schedule 1 – Codes, Linestyles and Examples*.

1.3.3.3 Digital data

The position of all points located during the survey are to be supplied in a digital format as specified in Section 1.3.3.3 (a) and by a medium as specified in the survey brief.

The transfer medium must carry a certification that it is 'virus free' with the name and version number of the anti-virus software used to scan the disk.

No digital information will be accepted without the 'anti-virus' certification.

This digital information will contain, but not be restricted to, the following information:

- the position of all survey marks placed or located during the survey, including survey stations, recovery marks, BM's and Permanent Survey Marks
- check observations to determine the accuracy of the instrument heights and azimuth setting on the total station
- if not consistent throughout the survey, the extents of various types of soil, exposed rock and vegetation
- the height and position of all watercourses, dams, swamps inundated areas and land slips
- the position and height of water levels in ponded areas, dams, lagoons, etc., as well as the position and height of any flood level information
- for earth dams and tanks, the position and heights of all walls and overflow spillways
- the position and height of any drainage structure, at both the inlet and outlet, as well as the position of any flood level information associated with the structure
- the position and height, where relevant, of any at surface indication of a public service utility
- if required by the brief, the position and height of the actual underground service, determined after the service has been exposed or otherwise located by the service authority

- the position and height of all existing roadway construction, including the edges of the pavement, shoulders, tracks, changes in cross fall and where required by the brief, pavement deformations
- the position of all traffic control devices including roadside signage, traffic lights, pavement linemarking and street lights
- the position and height of train and tram lines, including their associated drainage structures
- the position of overhead power and telecommunication lines and other services including the service number of the unit or pole number if available
- the position and height, if relevant, of all maintenance facilities, such as inspection boxes and manholes
- the position and height of natural or manmade features in order to control the subsequent triangulation and contouring process, so that the generated shape reflects the true shape of the ground surface to an accuracy as specified by the brief, and
- unless indicated in the 'Notes for Users' section in the field notes or the guidelines for locating feature points and sequential strings in the Survey Plot Code Library, the centre of point features must be located. Where the centre cannot be occupied directly, e.g., power poles, fence posts and trees, another method must be used to locate the centre so that the survey information includes the observations to the centre of the object.

a) **Formats**

The department requires the digital information to be in two formats.

- Field format

The observed field information:

- Total station – showing the instrument setup station details, radiated bearings and distances along with the standard feature codes and string numbers. An example of this format is available from the Project Manager on request.
- RTK GNSS – showing the base station used and its coordinates, coordinates of the discrete points along with standard feature codes and string numbers.

- Model format

The department's standard software is 12d Model. Digital information shall be in 12d archive format. Standard models are specified in *Schedule 1 – Codes, Linestyles and Examples*.

1.3.3.4 Survey Report

On completion of the survey, the Surveyor is to furnish a report detailing the conduct of the survey.

This report must include:

- any information, pertinent to the survey, that may affect either the design of the project or the department's future dealings with any of the landowners or occupiers
- variations from the survey brief and the reasons for such variations

- if approval was granted for the use of regulatory speed signs, the details of the location, relocation and times of erection and removal of the regulatory signs, for the duration of the project, and
- supplied Information.

All information, supplied as a part of the survey brief, is to be returned with the project deliverables. This includes any unused field notes, cadastral plans, survey books, aerial photographs, etc.

Evidence of the safety procedures adopted during the survey should be provided with the survey report.

1.3.4 Quality

Since the accuracy requirements refer to the relative uncertainty of located points to the reference frame, the marks used as the reference frame (Primary Control) must be submitted along with their origin and held co-ordinates. The observations and any network calculations that support the claimed accuracy of these new marks must also be supplied in the project record.

1.3.4.1 Quality checks

To verify the quality of both the survey information and the resultant terrain model, three specific string types have been included in the code list. Two are point type strings and the other is a line type string. These quality strings are to be used as either a part of the Surveyor's quality process and/or during a survey audit. All three strings will be directed into the survey quality model or layer and must be included in the information supplied with the survey.

a) Reference orientation checks

The reference orientation of the instrument must be set by sighting to and recording a reading to a known reference mark. This setting must be verified by sighting to and recording a reading to another known reference mark. This orientation must be checked periodically and re-set while the station is occupied. These readings must appear in the raw file as evidence of the implementation of a quality assurance system. The frequency of this re-observation of the reference orientation is to be adequate for the conditions.

Independent observations of angles when compared to the mean traverse angle, the difference shall not exceed 10 seconds of arc. Observation discrepancies outside this tolerance range must be resolved.

Observed distances to coordinated primary control, secondary control and side traverse stations are to agree within $(5 + 0.01*d)$ mm where d is the measured distance (in metres). Observation discrepancies outside this tolerance range must be resolved.

b) Quality point checks

When first set-up on a station for recording detail pick-up, quality marks must be placed and located at either extremity of the detail pick-up and adjacent to the instrument station. These marks are to be used as vertical quality assurance checks by re-observing the marks periodically throughout the set-up. The frequency of this re-observation is to be adequate for the conditions. The observations will appear in the raw file and give an indication of the quality of the survey procedures. As the instrumentation moves forward, the forward mark from the previous set-up is to be used as the back detail limit mark. In this way the detail limit marks will be located from multiple stations.

A report of the readings for orientation and instrument height checks is to be included in the project reports.

c) Quality line checks

Strings, denoted as 'quality line strings', are to be observed as checks on the ground surface defined by the Triangular Irregular Network (TIN), produced from the barrier strings and spot height strings in the *terrain model*. The levels of the plan position of these quality strings are to be compared to the TIN levels at that plan position and any difference reported. These quality line strings must be taken at discrete positions that do not coincide with the location of points in the barrier strings or the spot heights. This will give some indication of the interpolated heights in the *terrain model*. The extent of these quality line strings must be such that they give a good indication of the terrain surface (ground).

These check quality line strings should be established within 100 metres of the start and end points of the survey and at least every 500 metres between those points, with a minimum of three strings for any one survey.

If the height difference between the values of the audited points and the interpolated heights from the *terrain model* are greater than that required in the Section 1.3.1.4 (c) of this document or the survey brief, the discrepancies must be resolved by re-observing the terrain strings that create the TIN.

Notwithstanding the above requirements, it is the Surveyor's responsibility to verify and guarantee the reliability of their work within the required accuracies.

1.3.4.2 Height on survey marks

Height values for survey marks will be determined from the average of two-way independent differential level runs from a common datum. If possible, a secondary mark whose height is known, should be observed in order to verify the value of the primary mark. All BMs; Permanent Survey Marks; traverse stations; recovery marks; and quality marks located during the survey, shall be levelled in both runs.

The difference between values (or the maximum misclose in mm), as determined from the level runs, must not be greater than $12\sqrt{k}$, where k is the distance in kilometres from the datum mark. Refer Section 6.6.1 of *Part 1 – General Information* for further information on requirements regarding equipment and technique.

1.4 Purpose of Survey

Ground and feature model surveys may be required for a number of different purposes. Each purpose has varying requirements in the level of detail and quality required. The requirements presented in the Purpose sections below are in addition to the standard requirements of a GFM survey.

1.5 Purpose – Pavement

Pavement information may be required for either the full reconstruction of the pavement, or a widening and/or overlay scheme. In each case, the specific requirements are different and detailed below.

1.5.1 Full pavement reconstruction

As the road surface will be totally destroyed during reconstruction, information is only required on the general shape and geometry of the pavement surface. Information, therefore, will be restricted to those strings shown in the situational examples in Section 6.5.9 of *Schedule 1 – Codes, Linestyles and Examples*. There is no need to detail pavement deformations, unless specifically requested in the brief. Changes in pavement crossfall, such as lane boundaries, must be located and strung to control subsequent triangulation. Survey of features on pavement such as linemarking should be comprehensive.

The proposed centre of the new pavement may not always coincide with the centre of the existing pavement and the survey is to ensure that the width of information extends beyond any proposed Works. Particular attention must be paid to survey coverage in areas of deep cut or high fill. The extent of information will normally be indicated in the survey brief.

Care must be taken to place all primary control marks and where possible, secondary control clear of future earthworks and/or clearing Works.

1.5.2 Pavement widening and/or overlay scheme

In this type of scheme, the majority of the existing surface may be retained and, following some treatment, be incorporated in the final road surface. As this type of construction requires a greater knowledge of the pavement surface, the survey information must reflect the actual pavement surface rather than just the general shape and geometry. The survey information requirement includes that for full reconstruction, as well as any pavement deformation. The accuracy requirement of the pavement information is higher (refer Section 1.3.1.4 of this document).

Changes in pavement crossfall, such as may occur at lane boundaries, must be located and strung to control subsequent triangulation. Care must also be taken to define all rutting of the pavement surface. This may include locating extra barrier strings along the ruts.

The proposed centre of the new pavement may not always coincide with the centre of the existing pavement and the survey is to ensure that the width of information extends beyond any proposed Works. Particular attention must be paid to survey coverage in areas of deep cut or high fill.

In these circumstances, care must be taken to place all primary survey control marks and where possible, secondary control clear of future earthworks and/or clearing Works.

On some widening schemes, a cut-off line may have been marked along the pavement by the design engineer or details provided with the survey brief. This line represents the edge of the useful existing pavement, that is, where it meets the proposed widening. A string feature must be located along this line within the survey information.

1.6 Purpose – Bridge Surveys

1.6.1 Introduction

In the department, bridge surveys refer to a survey undertaken for the specific purpose of:

1. a new bridge structure
2. widening of an existing bridge structure, and
3. hydraulic studies associated with an existing structure which may have flooding issues which require investigation.

Surveys for bridges are essentially GFM with some specific requirements for the type of bridge survey requested. As such, the general requirements for GFM surveys, as set out in Section 1 of this document, will apply subject to the specific instructions in this Bridge Survey section or the survey brief.

Using the correct codes from the code library will ensure that the information will be placed in the correct model in the project so that all users can find and utilise the information. See *Schedule 1 – Codes, Linestyles and Examples* for a listing of the current codes.

These specifications outline the department's requirements for the provision of surveying services and products in relation to bridge surveys. The Survey requirements outlined in this chapter are related to the department's *Drafting and Design Presentation Standards Manual – Volume 3 Structural Drafting Standards*, especially *Chapter 8 – Bridge Widening* and *Chapter 20 – Electronic Project Model*. The department's *Hydraulic Guidelines for Bridge Design Projects* should also be referenced.

1.6.2 Scope

This section covers the express requirements for bridge surveys carried out for the department.

It should be noted that the surveys covered in this document do not include large scale hydraulic studies. Surveys for such studies should be covered by special instruction due to unique requirements for each area and the differing methods and software utilised by hydraulic engineers in constructing their models.

1.6.3 Environmental Impact

Bridge Site surveys that include streams or waterways are covered by various legislation requirements as detailed in Section 3.1.1 of *Part 1 – General Information*.

1.6.4 General requirements for bridge Site surveys

As stated, there are three general types of bridge surveys:

1. The possible location for the construction of a new bridge as part of any road transport infrastructure project. Such a Site may involve the construction of a bridge across a stream, watercourse, other body of water or natural feature, road, railway or other man-made structures.
2. It may also refer to a survey of an existing bridge structure for bridge widening purposes, or
3. For hydraulic studies associated with an existing structure which may have flooding issues which require investigation.

All of these bridge survey types require some form of GFM Survey.

1.6.4.1 Area of interest for the GFM survey

The area over which the GFM is to be established should be clearly defined in the survey brief. If this is not the case then the Surveyor is to ensure that the area covered at least 20 m left and right of the proposed bridge centreline. This area should be extended where warranted to include any existing features and structures that may have an influence on the design of the bridge structure.

1.6.4.2 Bed levels

The Surveyor is to ensure that a true representation of the stream bed is produced over the terrain area of the GFM. Where the bridge Site covers any body of water, soundings must be taken to determine the true bed levels. These must be entered into the digital data for the GFM.

1.6.4.3 Subsidiary information outside of the GFM

For watercourses, there is a requirement to collect information outside the defined terrain definition area to support the hydraulic definition for the bridge design. Sufficient bed levels are to be obtained for at least 100 m, or until a height difference of at least 0.3 m is obtained, both upstream and downstream, to determine the average bed gradient. This information is additional to the recorded information to define the terrain area for the project. It is to be recorded using the appropriate stream codes from *Schedule 1 – Codes, Linestyles and Examples*.

These strings have the same feature function as the terrain definition strings from the terrain model, but will not be included in the terrain model for triangulation purposes.

Irrespective of the fact that terrain definition strings from the terrain model are used in the terrain area to define the watercourse for contouring purposes, the stream gradients codes should still continue through the terrain area. This may entail the stream gradient codes being dual-coded with the terrain codes within the terrain definition area.

Locations of the stream banks are also to be recorded at least 100 m upstream and downstream from the proposed bridge centreline or coincide with the bed definition strings. This information is to be coded as per the relevant code list in *Schedule 1 – Codes, Linestyles and Examples* for stream definition codes. These strings have the same feature function as the terrain definition strings from the terrain model, except that they will not be included in the triangulation to define the terrain area. The standard terrain codes will still be used to define the banks within the confines of the GFMs terrain area and, unlike the stream gradient strings, these non-terrain bank codes will simply be an extension of the terrain bank codes outside the terrain area. There is no requirement for these strings to be dual-coded.

The stream information is to include the location of any scouring or tributaries of the main stream, as well as any anabranches and flood channels entering or leaving the main stream.

1.6.4.4 Hydraulic data

All hydraulic analysis requires topographical survey to define the flow paths and the flood patterns in stream channels and floodplains. Relevant information is to be obtained to allow designers to develop a suitable hydraulic model for the proposed structure.

The flow in routine waterways can be regarded as one-dimensional. That is, the flow occurs in a watercourse or channel and most 'normal' rivers and creeks, including small ones, fall into this category. Most bridge and culvert studies for the department will be of this type and will generally consist of defined channels and cross-sections.

Complex floodplains are ones where there is no clearly defined channel or flow path and floodplain flow occurs over a wide expanse. In this case, a true two-dimensional hydraulic model is required to analyse the complex distribution of flow. In two-dimensional models, the distribution of flow is determined by the topography, and not by defined channels and cross-sections. Extensive survey data is required and is normally captured with photogrammetry or Airborne Laser Scanning (ALS).

Catchment maps

A catchment map is required to provide details of the catchment area, stream length, slope and factors influencing the run-off co-efficient. While most hydraulic requirements are obtained from aerial photography and topographic maps, specific requirements should be covered in the survey brief. The following information will usually be required:

- catchment area
- information on existing stream structures, within 500 m of the bridge site for small catchments and within 2 km for large catchments, in order to determine the performance of that structure. The information required for bridges will include:
 - a stream cross-section at the bridge opening
 - soffit levels
 - number of spans and pier positions and size, and
 - deck type and level.
- for existing culverts the information required will include:
 - number of cells
 - openings or sizes, and
 - invert levels.

Ground descriptions

Data in the form of position and comments is required on soil and rock types in the bridge Site area that may be relevant to foundation design. The position of any deposits of sand and gravel which appear suitable for construction purposes should also be located and noted. Also, the type of country, e.g., flat, rolling, steep, etc., and vegetation cover, e.g., bare, rocky, grassed, cultivated, lightly timbered, heavily timbered needs to be recorded.

A large part of this information may be gathered from aerial photography, topographic maps, airborne laser scanning and terrestrial photography. These may also be included with the field notes to assist the designers in identifying these requirements.

Watercourse bed profiles

Sufficient bed levels are to be obtained for at least 500 m, both upstream and downstream to determine the average bed gradient. These are to be extended if the bed is irregular over this length in order to more accurately indicate the average gradient. Where there are permanent or semi-permanent waterholes, the water level, as well as the bed level, should be recorded.

This information is to be coded as per the relevant code list in *Schedule 1 – Codes, Linestyles & Examples*. These strings will use the same macro and have the same feature function as the normal codes for drainage, except that they will not be included in the triangulation to define the terrain area. The standard terrain codes will still be used to define the drainage within the confines of the GFMs terrain area and the non-terrain codes will simply be an extension of these codes outside the terrain area.

Particularly for streams where it is difficult to determine the direction of flow from the contours, it will be necessary to define this direction of flow. This may occur where there is a series of waterholes, or where deposits of sand or gravel make it difficult to determine the direction from the averaged bed gradient.

Watercourse cross-sections

For routine waterways, the standard hydraulic analysis procedure uses backwater analysis, which calculates water levels from downstream to upstream, therefore cross sections are especially important downstream of the structure site but are required upstream also.

The recommended survey requirements are for sections to be taken at spacings of approximately one hundred metres (100 m) to extend five hundred metres (500 m) upstream and five hundred metres (500 m) downstream. These cross-sections should be at right angles to the flow and should extend to higher than the highest expected flood level, so that the model can represent all of the flow.

Additional cross-sections are to be obtained at the following locations:

- at significant changes to the stream profile gradient
- where there is any considerable variation in its shape, and
- at pinch points in the watercourse.

Survey information is to be located using the relevant string codes from *Schedule 1 – Codes, Linestyles and Examples*. These strings will not be included in the terrain area for triangulation purposes but, along with the watercourse bed profiles from the previous section, will provide the means of obtaining flood profiles of the watercourse system.

Photographs of the locations of the surveyed cross-sections should be taken to aid in hydraulic analysis of the site.

Flood data

Unless otherwise directed, comprehensive flood information is to be obtained from all available sources. These sources may include but not be limited to:

- flood debris
- land owners / occupiers
- school bus operators / general carriers
- mail Contractors
- police
- Royal Automobile Club of Queensland Limited (RACQ)
- local authorities, and
- DoR flood gauge information.

The information obtained is to include:

- the frequency of floods at various levels with their respective times of submergence, particularly that of maximum known and other high floods, stating the years in which they occurred

- where there is an existing bridge, the frequencies and time of submergence at various heights are to be noted
- information on backwater from floods in adjacent watercourses is important and should be as detailed and as accurate as possible
- data is to distinguish as much as possible between local run-off and the less frequent, but possibly higher backwater, from larger streams. The effects of these should be considered both separately and in combination
- the time estimated to elapse between the start of heavy rain and that of maximum flood at the bridge site if possible, and
- the water level at which timber or heavy flood debris first reaches the bridge site and the nature and amount of the debris.

Flood levels

Levels are required of definite marks on flood gauges and DoR's Bench Marks adjacent to bridge Sites, with data adequate for their identification. These, together with all flood level points provided by the flood data information, are to be located for horizontal and vertical position by using the designated point code from *Schedule 1 – Codes, Linestyles and Examples*.

Flood debris

Levels on flood debris should be taken at numerous points, both upstream and downstream to assist in gauging the flood gradient. This flood debris information should include but not be limited to:

- position and height of the debris
- type of debris, e.g., grass in trees or logs, and
- size and amount of the debris.

The designated point code for flood debris from *Schedule 1 – Codes, Linestyles and Examples* is to be used to obtain horizontal and vertical position for each individual debris level.

Stream flow

Data is required on rock, or such alluvial material in the stream bed that would indicate typical or recent stream velocity, or recent scouring adjacent to the site.

Comment is required on the apparent stability of the banks and whether or not the increased velocity of the stream created by the possible restrictive action of the proposed bridge would cause erosion.

Flood Channel

Where a depression adjacent to the main stream could be a flood channel, it is to be examined both upstream and downstream to determine whether it is a depression or a true flood channel connected to the main stream. Flood channels are to be surveyed to the same requirements for the main channel.

Tidal streams

In tidal streams, high and low tide levels are required, together with the times and dates of the readings. Where the duration of the survey permits, high and low tide levels together with times and dates should be obtained each day.

Should the designers require a more sophisticated hydraulic model, specific instructions are to be contained in the survey brief.

1.6.4.5 Bridges across other features or structures

Bridge Site surveys for structures over other features or structures are to include detailed accurate data for all features in the designated area. Terrain information is to be obtained to produce an accurate terrain model in the same area. Where the survey brief does not define such an area, coverage should extend beyond any terrain or feature that may affect the design of the structure.

1.6.5 Bridge widening surveys

Bridge designers have specific requirements for locating existing bridges and their relevant features in the case where an existing bridge is to be widened or re-decked. If drawings of an existing bridge are not available, the survey should accurately define the shape of abutments, piers and decks in more detail than required in simply locating a bridge and its features.

Designs for the widening of bridges vary greatly depending on the types of existing structures and the width of the widening required.

For bridges to be widened, an accurate bridge survey is required so that 'As Constructed' details are supplied to the Design Officer.

1.6.5.1 Reference diagrams

These reference diagrams show structure features located by dimensions from a clearly defined bridge control line. Surveyors may use an alternative method to give positional information, such as a co-ordinate system, which satisfies the relative uncertainty positional requirements of a GFM survey (refer Section 1.3.1.4 of this document).

Where critical dimensions are required, a reference line is to be established through the required features and the spacing's recorded by direct measurement.

1.6.5.2 Structural drafting standards – bridge widenings

Chapter 8 – Bridge Widening of the departments Drafting and Design Presentation Standards Manual – Volume 3: Structural Drafting Standards states that 'Because of the small tolerances involved in bridge construction, the bridge survey must be accurate to within 5 mm. The survey of the ground must be accurate to within 100 mm.'

While this bridge survey height component can be achieved, the horizontal positional accuracies are generally beyond the capability of GFM surveys to provide at this time. However, critical dimensions can be measured directly by other means to this accuracy from a locally established reference line. Where critical features such as anchor bolts, transverse stressing bars and features that require precise connections are located, then this reference line method will be used. The survey of the ground shall adhere to relative uncertainty requirements for 'other', that is 50 mm.

Figure 1.6.5.2(a) – Bridges widened on both sides

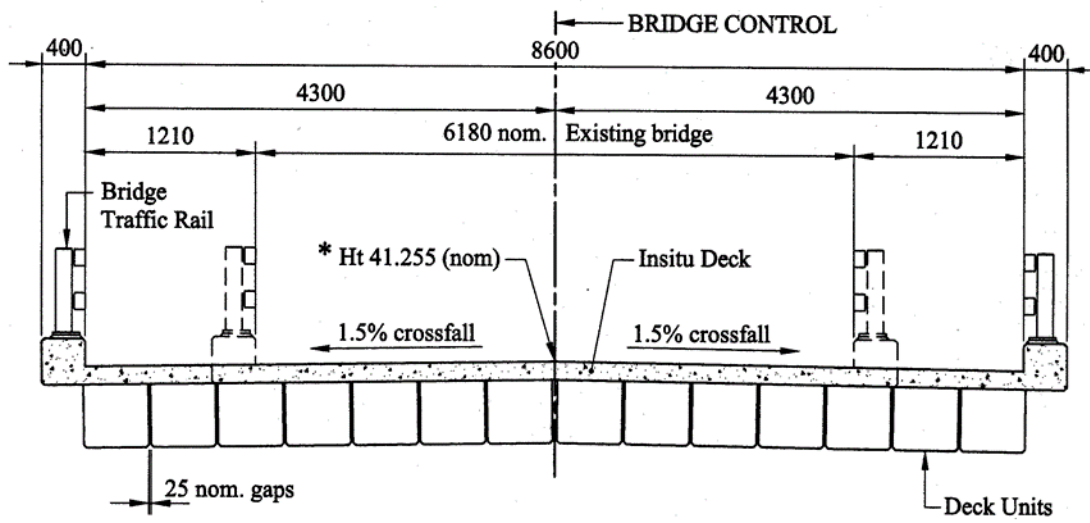

* Delete Height if bridge is on a VC or Grade

Figure 1.6.5.2(b) – Bridges widened on one side

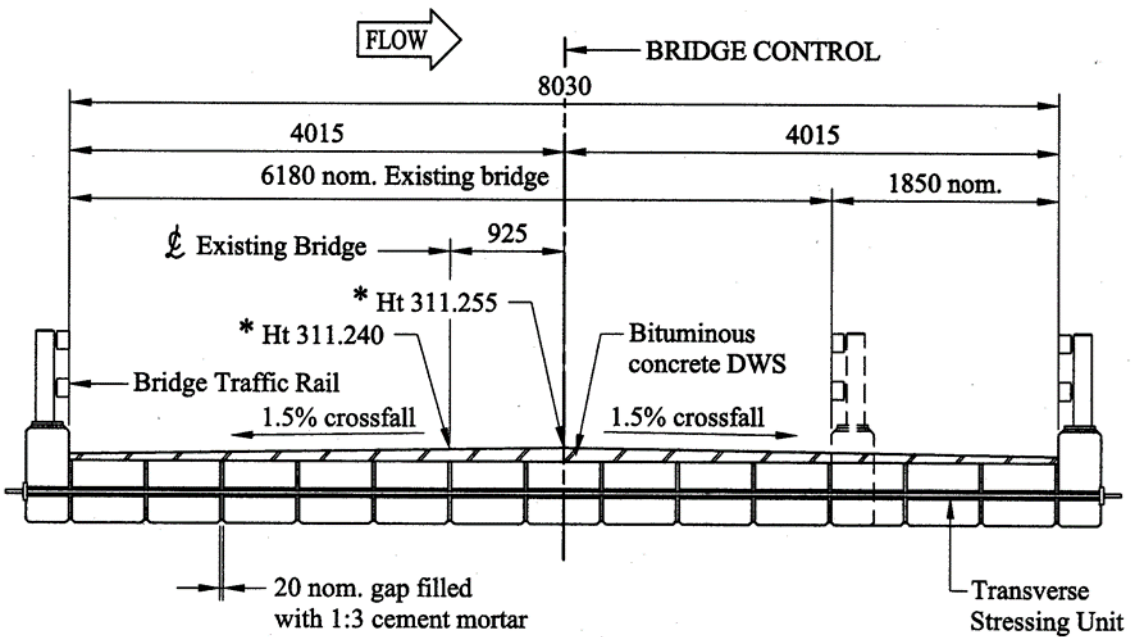

* Delete Height if bridge is on a VC or Grade

Figure 1.6.5.2(c) – Survey information required for bridge widening

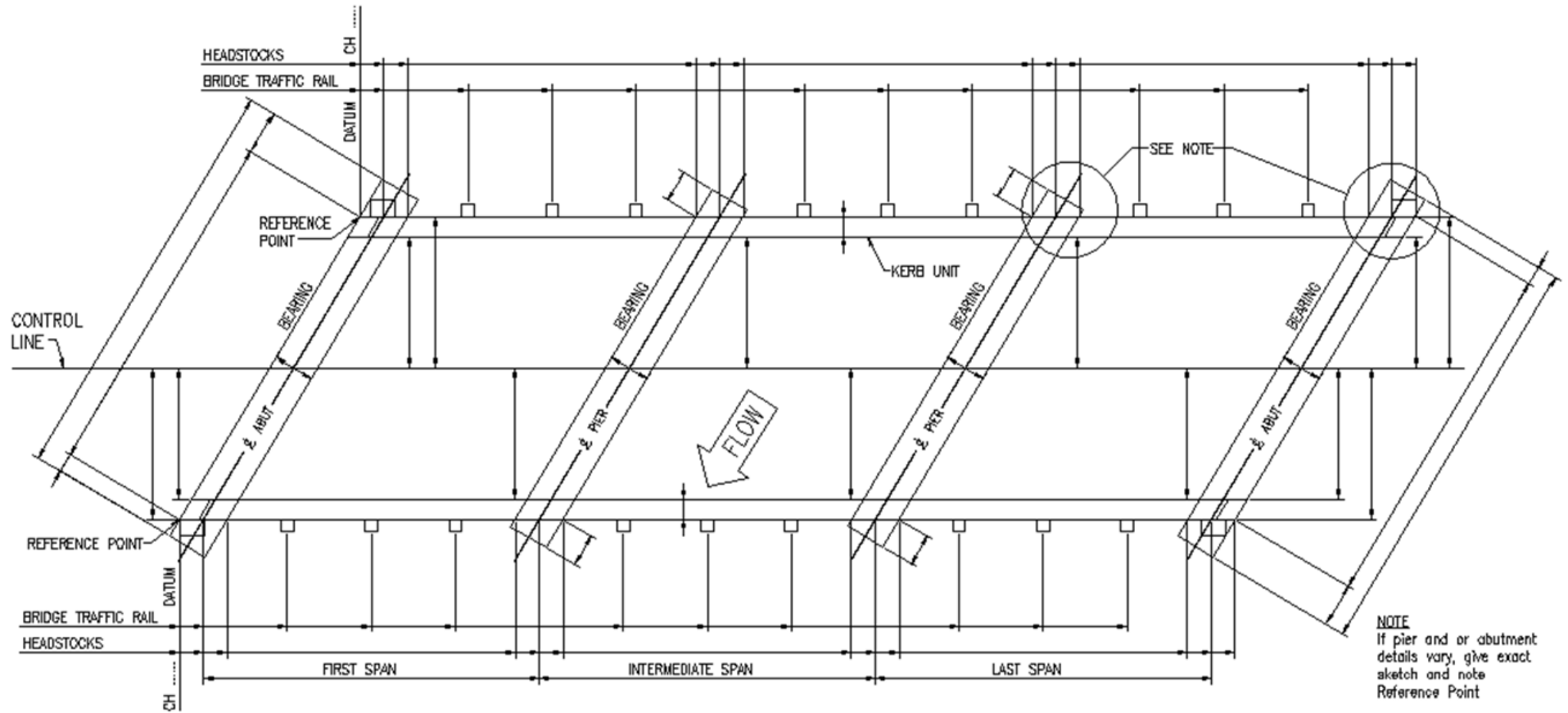

Figure 1.6.5.2(d) – Survey information required for widening deck unit bridges

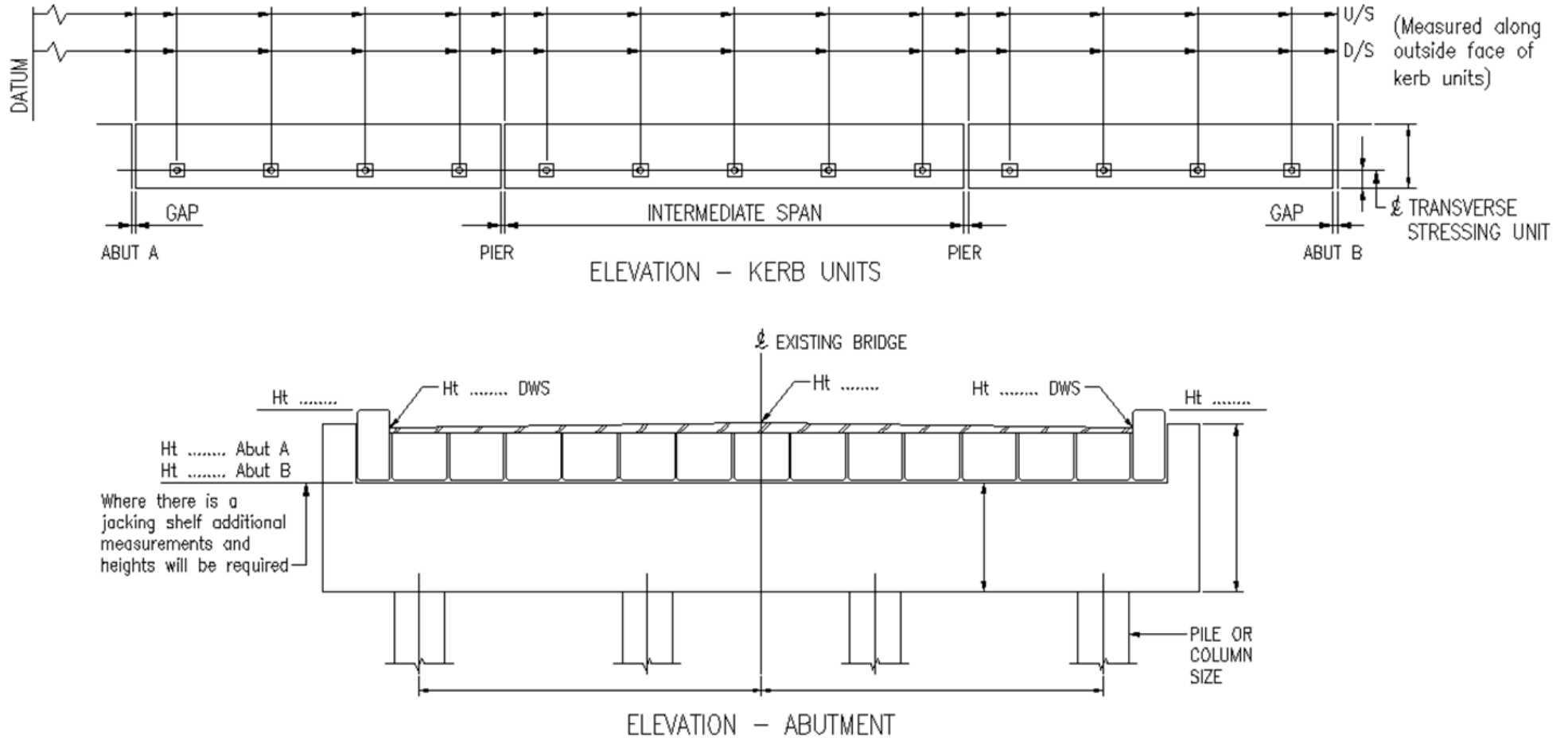
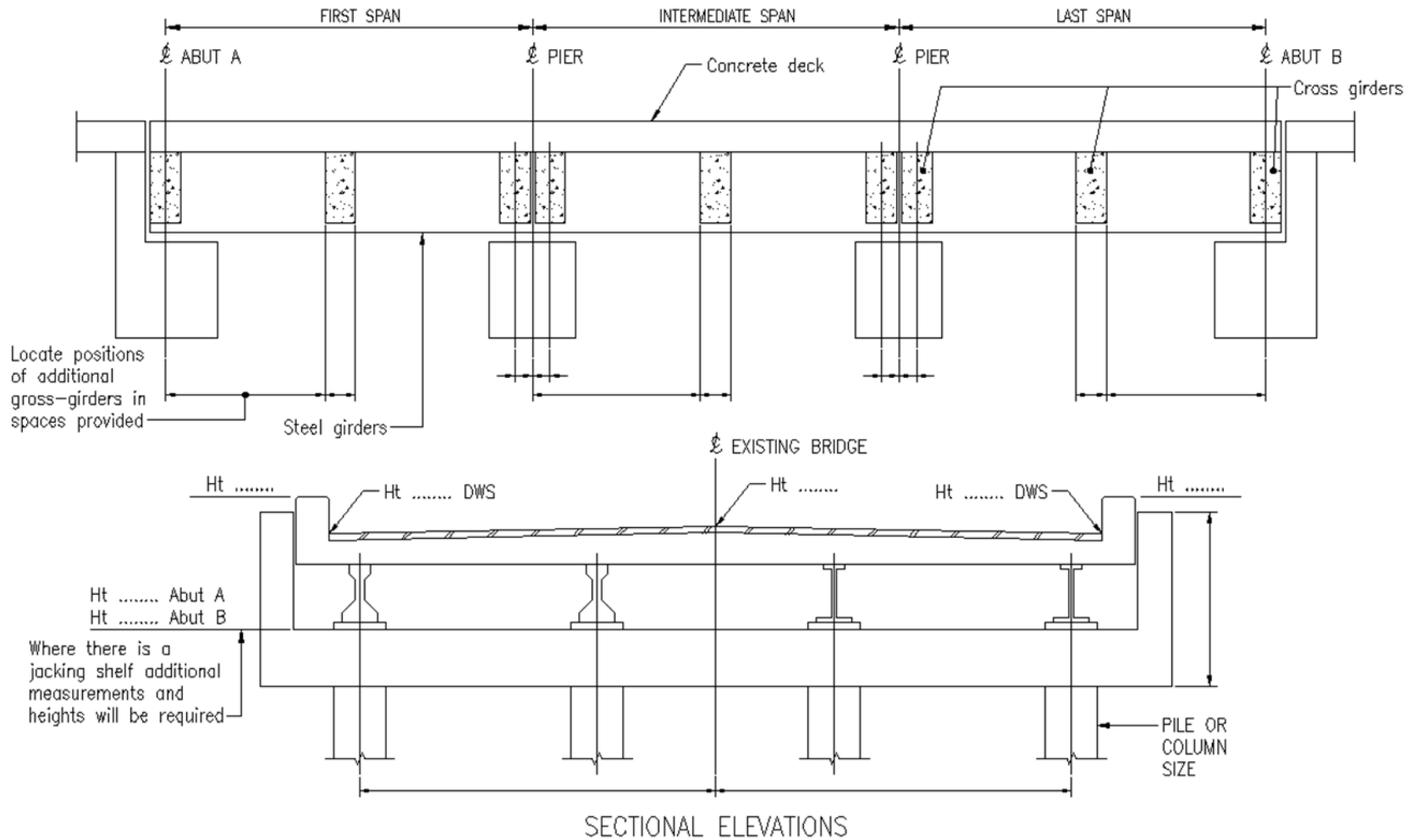

Figure 1.6.5.2(e) – Survey information required for widening girder bridges



1.6.5.3 Survey information for bridge widening

For bridges to be widened, an accurate bridge survey is required so that 'As Constructed' details are supplied to the Design Officer. This detail should include the following information so that structural drafters can produce new bridge drawings of a widened structure which fits seamlessly to the existing bridge structure.

Figure 1.6.5.2(a) to (e) show features located by dimensions from a clearly defined Bridge Control Line. If there are no design drawings of the existing structure, then this bridge control line may not be available to reference the dimensions. Surveyors may use an alternative method which satisfies these requirements, but delivers the same information in a different form, e.g., co-ordinates.

Alignment

- The line of the bridge given by a located control line.
- The direction of gazettal of the road should be noted on the control line.
- The position of each kerb unit. Refer Figure 1.6.5.2(c) (a reference line should be established on the kerb to record distances to locatable features).

Kerb features

The following features are to be located along the outside face of kerbs:

- faces of pier and abutment headstocks
- centreline of pier headstocks
- centres of bridge railing posts, and
- on deck unit bridges:
 - centres of transverse stressing bars at outer face of kerbs (the centres, tops or bottoms of the bars may be used to locate them, but whichever method is used must be conspicuously recorded in the comments for the pick-up to avoid confusion)
 - protrusion of transverse stressing bar from nut
 - type of transverse stressing bar – Macalloy Bar (Imperial thread 1 1/8" dia.) or
 - VSL Bar (Metric Thread 29 mm dia.), and
 - hog of kerb unit.
- on girder bridges:
 - centres of cross girders, and
 - dimensions of diaphragms.

Dimensions should be taken from a reference line, which is located in the project co-ordinate system and related to the road chainage. This reference line should clearly relate the features on the concrete structure with running dimensions and directions. On multi-span bridges, details should be supplied for each span.

Height information

- heights are required on bitumen or concrete deck at each kerb and at centre of roadway if crowned – heights should be provided at abutments and piers with additional intermediate heights being required at approximately three metre centres along all spans of the structure
- height of transverse stressing bars above soffit of units – all bars and all spans
- thickness of any Deck Wearing Surface is needed at the abutments and piers, adjacent to the kerbs (this may be achieved by driving a spike into the Deck Wearing Surface (DWS) to record penetration depth)
- heights are also required, where possible, on the bearing surfaces of piers and abutments.
- **depth of bitumen or concrete deck below top of kerb
- **depth to soffit of outside kerb units or cast Insitu kerb.

****Depth** Dimensions are required at points where levels were taken as required in the first dot point. This information may not all be required for Insitu decks if the kerbs were uniform.

Note the position of heights recorded should be clearly defined, see Figure 1.6.5.2(d) and Figure 1.6.5.2(e) for examples and typical locations.

Terrain information at abutments and piers

- Supply sufficient terrain information so that designers can establish profile of ground surface at the top and the toe of existing rock masonry, concrete wing walls or other batter protection.
- Provide terrain information in the vicinity of proposed abutment and pier extensions.

Water levels and tidal zones

- Provide water levels of creeks and rivers.
- If in tidal zone:
 - high and low water levels, and
 - time and date of surveyed levels.

Other information

- Flow direction, as indicated in Figures 1.6.5.2(b) and (c) is to be included.
- Other dimensions, as indicated on the diagrams of Section 1.6.5.2 of this document, are to be supplied where possible.
- Details of services and other features that the Surveyor may consider necessary should also be provided.
- Areas of the structure and abutment protection showing signs of deterioration or erosion should be defined and photographs supplied.
- Condition of deck wearing surface and expansion joints should be reported on and photographs supplied.
- Other photos of bridge features.
- Note the existence of relieving slabs at the bridge site.

1.6.5.4 Bridges to be widened on one side

For bridges that are to be widened only on one side, detailed information is required only on the widened side, except that dimensions will be necessary on the non-widened side to define:

- the bearing of pier centre lines
- the bearing of abutment faces
- the bearings of transverse stressing bars, and
- if new rails are to be provided on the non-widened side, dimensions will be required to the centre of bridge railing posts on both sides of the bridge.

1.6.6 Railway overbridges

- The bearing of the centre lines of all tracks and the chainage of the intersection of track centre lines with the traverse line.
- Levels on both rails of all tracks are required at five metre intervals for a distance of 50 metres either side of the bridge.
- Levels are required at the soffit of girders or deck units directly over the rails, both sides of bridge.
- Existing clearance from the centreline of tracks to the face of piers and abutments should be shown on a detailed sketch.

1.6.7 For road overbridges

- Levels at five metre centres are required on the existing underpass roadway for a distance of 50 metre either side of bridge. Levels are required both sides of pavement and at centreline if roadway is crowned.
- Levels are required on the soffit of girders or deck units over the roadway, both sides of bridge.
- Existing clearances from the roadway to faces of piers and abutments should be shown on a detailed sketch.

Note the requirements given in this chapter do not cover all bridges that may be widened – for example, bridges with footwalks, Arch bridges, steel bridges wood bridges, etc.; however, the general principles outlined above should be used as the basis to location of relevant information for designers.

1.7 Purpose – Underground asset investigation

1.7.1 Introduction

The survey brief may require underground assets to be located in addition to what is exposed at ground level as part of a GFM survey. The general requirements for GFM surveys will apply subject to the specific instructions in this Underground Assets section or the survey brief.

Underground assets can include but are not limited to:

- Public Utility Plant (PUP). This includes any essential commodity or service, such as water, electricity, telecommunications, gas, sewer, fuel, stormwater pipes, light pole footings, electricity pole footings, thrust blocks and so on that is for a public service.

- The Department of Transport and Main Roads Intelligent Transport Systems and Electrical (ITS & E) includes traffic light mast arm footings, traffic light pole footings, street light pole footings and all associated ITS & E electrical conduits and inspection pits.
- Structures such as large sign pole footings, retaining wall footings, bridge pier footings and any other permanent structure under the natural ground surface.

Australian Standards Classification of Subsurface Utility Information (SUI) AS 5488.1-2019 and AS 5488.2:2019 provides a framework for the classification of subsurface utility locations and attribute information in terms of specified quality levels. The system presented within these departmental Standards has been setup to enable mapping out to AS 5488.1-2019 and AS 5488.2:2019 classification quality levels.

1.7.1.1 Existing records

The survey brief may call for existing records of service utilities to be included with the surveyed data. Existing records may be sourced from Dial Before You Dig (DBYD), service providers and local government authorities. All existing record data will be classed as DBYD and coded appropriately. Existing records may be transformed using surface features as points of reference. Transformed data retains DBYD classification with appropriate annotation to alert users that it has been manipulated. Heights of DBYD data are to be null.

1.7.2 Training and accreditation

All personnel undertaking underground asset investigation must be trained and currently accredited in accordance with the requirements of the owners of underground assets. This may include restrictions by the asset owner on lifting inspection lids. All personnel entering pits and other confined spaces must be trained and accredited in confined spaces at the time of survey.

1.7.3 Locating methods

A number of locating methods can be utilised to provide the information required to position and attribute underground assets. The asset may be physically potholed or a remote system like electronic geophysical cable location and ground penetrating radar may be used. Each locating method used to locate underground assets has an attribute description label which shall be the first comment attributed to the point. Underground assets must also have the depth of cover commented on the points.

The locating method can be or a combination of the following.

1.7.3.1 Surface indicators and exposed assets at ground surface

Surface indicators include manholes, inspection pits, valves, and telecommunication markers. Assets may be exposed assets at ground surface e.g. Water main or sewer rising main. Positional accuracies must meet the criteria as specified for service utilities in Section 1.3.1.4 (a) and (b) of this document.

1.7.3.2 Potholing (PH)

Assets can be exposed by potholing and during construction Works. Positional accuracies must meet the criteria as specified for service utilities in Sections 1.3.1.4 (a) and (b) of this document. This method of capture requires the attribute description label 'PH' with a measured depth of cover 'C' to be recorded as an attribute (comment) on the captured point (refer Figure 1.7.3.2(a)).

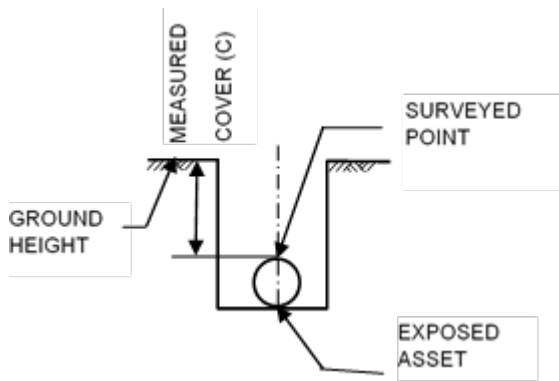
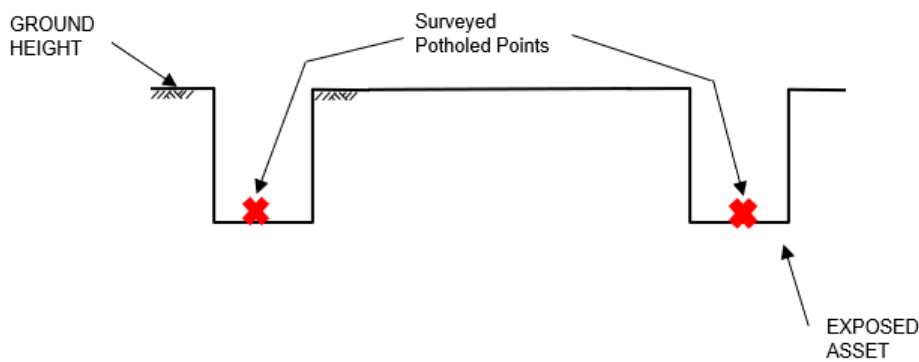
Figure 1.7.3.2(a) – Potholed service “PH” cross section**Figure 1.7.3.2(b) – Potholed service “PH” long section**

During construction works, assets may be partially or fully exposed. Exposed assets must be captured by at least two discrete points as a stringline (similar to Figure 1.7.3.2(b)). Sufficient intervals of discrete points should be captured to achieve an interpolated accuracy no greater than the accuracies specified for ‘Other hard surfaces’ under Section 1.3.1.4(c). This method of capture requires the attribute description label ‘PH’ with a measured depth of cover ‘C’ to be recorded as an attribute (comment) on the captured point.

1.7.3.3 Backfilled pothole (BP)

Whilst not ideal, in some situations potholed and newly laid services are backfilled before the Surveyor has located the exposed service. Where possible this scenario should be avoided, however it is in some situations unavoidable.

If a 3rd party places location markers and records depths of backfilled potholes, when surveyed, the attribute description label ‘BP’ with a measured depth of cover ‘C’ is to be recorded as an attribute (comment) on the captured points. The resultant position of the captured point must be at the correct service height, not ground height.

1.7.3.4 Cable locator (CL)

Tracing and marking of underground assets at the ground surface may be done by electronic geophysical means such as electromagnetic field (EMF) technology. Ground marking with indicative depths shall be at less than 10 metre intervals on linear runs and at all changes in direction for all services. The resultant position of the captured point must be at the correct service height, not ground height.

This method of capture requires the attribute description label 'CL' with an indirect measured depth of cover 'D' to be recorded as an attribute on the discrete point. (refer Figure 1.7.3.4(a)).

This method must not be used for Telstra assets (refer Section 1.7.3.5).

Figure 1.7.3.4(a) – Type 'CL' Cross-section

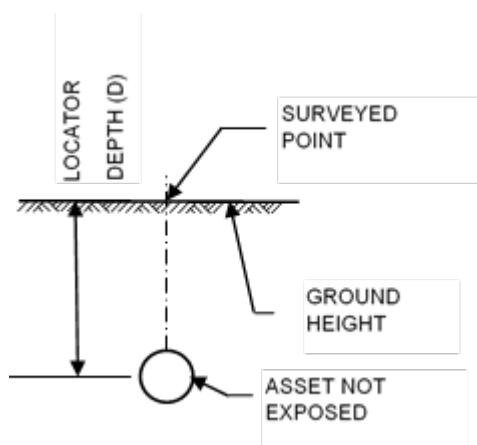

When using electronic geophysical means to trace underground assets, a depth reading is sometimes unobtainable due to poor signal strength. These points shall record heights at ground level and use a locating method description label 'CLH' with an additional comment of "No depth" to be recorded as an attribute on the discrete point (refer Figure 1.7.3.4(b)).

Figure 1.7.3.4(b) – Plan view of EMF technique

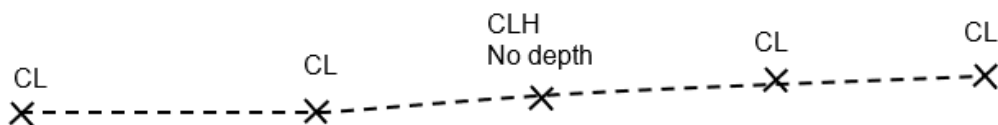

1.7.3.5 Cable locator – horizontal (CLH)

Under Telstra's Duty of Care, all Telstra underground assets located using electronic geophysical means are not permitted to provide a depth of communications plant, unless it is physically exposed by hand digging.

All Telstra underground assets located using electronic geophysical means shall be located at ground level and require the attribute description label 'CLH' with an additional comment of "No depth" to be recorded as an attribute (comment) on the captured point unless specific conditions are met as specified in TN157 *Underground Asset Investigation*. Ground marking shall be at less than 10 metre intervals on linear runs and at all changes in direction.

When using electronic geophysical means to trace underground assets, a depth reading is sometimes unobtainable due to poor signal strength. These points shall record heights at ground level and use a locating method description label 'CLH' with an additional comment of "No depth" to be recorded as an attribute on the discrete point (refer Figure 1.7.3.4(b)).

1.7.3.6 Ground penetrating radar (GPR)

GPR may be a useful technique to locate services under pavement or concreted areas. The section of the asset traced by GPR shall be validated by potholing at each end of the section and at intervals no greater than 20 metres.

This method of capture requires the locating method description label 'GPR' with an indirect measured depth of cover 'D' to be recorded as an attribute (comment) on the discrete point. Potholed locations must meet the same requirements as specified in Section 1.7.3.2 of this document.

1.7.4 Attribute Information

Attribute information shall include, but is not limited to:

- locating method description code: potholed (PH), backfilled pothole (BP), cable located (CL), cable located horizontal (CLH), Ground Penetrating Radar (GPR)
- asset owner
- the asset type
- size
- asset material
- position quality level (automatically generated from locating method description code)
- date of installation (if known)
- asset condition (if known), and
- status (if known): for example, "In Service"

The feature code may provide some of this information and therefore does not require duplication as attributes. The status of the service should only be attributed if a representative of the utility service provider expressly confirms such.

Points are to be commented in the following format, consisting of a minimum of three words with a space between the words:

<u>Word 1</u>	<u>Word 2</u>	<u>Word 3</u>	<u>Word 4</u>
Locating_Method+depth	Size+material	Owner	Misc. comments

Example:

CL500 100PVC BCC top of pipe

1.7.5 Position quality level

The position quality level of located points is described in terms of relative uncertainty within the project's reference framework. The position quality level is to be attributed to the located points.

Table 1.7.5 – Position quality level

Locating method description code	Horizontal Relative Uncertainty +/- (m)	Vertical Relative Uncertainty +/- (m)
Potholed (PH)	0.025	0.025
Backfilled pothole (BP)	0.1	0.1
Cable locator (CL)	0.3	0.5
Cable locator horizontal (CLH)	0.3	N/A
Ground penetrating radar (GPR)	0.3	0.5

2 Audit surveys

2.1 Introduction

An Audit Survey is a survey undertaken to determine the compliance of a completed survey with the Standards and any special requirements specified in the survey brief.

2.1.1 Purpose

This chapter outlines the department's requirements in performing a survey to audit:

- previously completed surveys
- component lots of a construction project, and
- 'As Constructed' records of a construction project

It ensures that the previous survey has been carried out in compliance with the Standards and that it also satisfied the requirements of the survey brief. It also ensures that a survey undertaken for the department is 'fit for purpose' and the data / methodology is appropriate to achieve that purpose.

Generally, Audit Surveys are carried out on a random 'sample' basis – increasing or decreasing sample 'lots' depending on specifications, accuracies and tolerances met and past performance.

2.1.2 Scope

This chapter provides guidelines in auditing a survey and/or the deliverables of a survey brief. It also provides guidelines in performing construction audits to determine compliance with the project specifications and current design (original design plus amendments). Any audit of a survey or construction project need not be limited to the aspects covered in this specification.

2.2 Audit procedure

An audit of a survey should be conducted to an extent commensurate with the performance level of the source supplier. A survey supplied from an unknown source or a source with poor audit history should be audited in detail, while the audit of a survey supplied by a source with a good audit history, robust quality assurance procedures and checked results may be limited to a general overview of key deliverables and quality information.

As stated previously, a GFM survey essentially consists of four components:

1. Location – positional information to represent detail in its correct relative position.
2. Definition – accepted descriptive representation of the detail and its component attributes.
3. Presentation – present the collected detail in a format that is usable, understandable and unambiguous.
4. Quality – systematic methodology and self-checking procedures to assure the integrity of the information.

The audit procedure assesses the survey in reverse order of these components in increasing complexity.

Audit level 1

A simple audit is to ensure the Quality Assurance (QA) procedures undertaken assess the other three components and confirm the self-checks are consistent with the stated deliverables in the survey brief.

Audit level 2

A more complex audit is to add to the Level 1 audit by 'bench testing' the survey by checking the presentation of the deliverables and confirming the integrity of the presented information with any pre-existing information in the project area.

Audit level 3

Level 3 audits build on the Level 2 audit by the addition of code checking with field checking the veracity of the entity coding. A useful tool is to use the verification plots supplied with the deliverables and walk the project area to ensure all salient features are located.

Audit level 4

Level 4 audits combine the previous levels and also checks the relative uncertainty of the detail and can even include checking of the positional uncertainty of the control.

The density of the samples that are confirmed in the audit will depend on many factors, but should be stated in the survey brief.

2.3 Pre-design surveys

The predominant use of Ground and Feature Model surveys is for pre-design for a construction project.

The primary requirement of an audit of a pre-design survey is to ensure that all project deliverables conform to the Standards, as well as conform to any variations to those Standards that may be listed in the survey brief issued for the survey.

Secondary requirements of an audit include checks on survey processes to assess proficiency, checks on quality to assess accuracy and checks for obvious errors and/or omissions in the project deliverables.

2.3.1 Audit level 1

Initially, the following checks should be made to provide an overview of the probable quality of the deliverables.

2.3.1.1 Survey book

A cursory inspection should be made to ensure the following details have been provided in an acceptable way:

- general presentation
- completed details – cover and inside cover
- signature and date
- check for inclusion of:
 - index
 - datum

- summary of survey monuments used / located
 - traverse
 - levels
 - QA, and
 - sketches.
- hard copy of all field observations in an approved format, e.g., electronicSurveyBook, and
 - appropriate and sufficient cross-referencing – the survey book must contain sufficient information to stand alone as a source of reference for the survey.

2.3.1.2 Digital data

The data provided on the computer media should be inspected to ensure it conforms with the following requirements:

- medium type is as per the survey brief or as previously agreed
- the data is certified to be virus free
- format of electronic files is as per the Standards or as requested in the survey brief, and
- files are readable (i.e., can be 'transferred' from the delivered medium).

2.3.1.3 Verification plot

The verification plots provided should be checked for the following requirements:

- plot scale, plan size and colour are as per the survey brief or as previously agreed
- plots easily readable and signed as verified
- no obviously incorrect or missing line styles or contours, and
- disclaimers where needed (for example, on cadastral boundaries).

2.3.2 Audit level 2

When the Audit Level 1 general overview of the deliverables produces unsatisfactory results or when auditing a pre-design survey from a Surveyor with a poor or unknown audit history, a more detailed Audit Level 2 is undertaken.

2.3.2.1 Survey book

In depth checks are to be made on the data provided in both the survey book and the hard copy of the field observations. These would include, but not be restricted to, the following:

- valid information is included on the cover and inside cover
- positional, height and co-ordinate datums used conform with the survey brief
- positional, height and co-ordinate origins used are correctly referenced to their datums
- type and condition of marks
- traverse sketches, correctly annotated with datum, station identifiers, co-ordinates, traverse bearings and horizontal distances
- datum establishment justification statement where appropriate

- sufficient recovery marks placed and recorded to allow re-establishment of the project projection
- recorded field observations that demonstrate both the accuracy and correctness of calculations for the recorded traverse bearing and distances (QA)
- horizontal accuracy requirements are met
- the presence of two independent, continuous level flights containing all staff observations, including full levelling reductions and check calculations
- each independent level flight records the height of all new and existing BMs, PSMs, Instrument Stations and Quality Assurance Check Points recorded calculations showing method of calculating both the height datum and the adopted mean heights of all BMs, PSMs, Instrument Stations and Quality Assurance Check Points – where automatically reducing digital levels are used, the print-out of the readings and reductions is to be provided
- height differences between both independent level flights meet accuracy requirements
- sufficient cross-referencing of all levelled marks to digital data
- sufficient cross-referencing of levelled original BMs or PSMs to Form 6 information or original Survey Books
- clear sketches detailing the dimensions of standard objects (e.g., kerb types)
- clear cross-referenced sketches or descriptions of any details not included in the digital data, including structures, vegetation, soils, land usage and flood information
- correct transference of positional co-ordinates and mean heights of instrument stations from survey book to instrument station set-up data
- all radiated sight lines are limited to lengths to allow the required horizontal and vertical accuracies to be achieved
- radiated data at each instrument station set-up includes the specified minimum number of Quality Assurance Check Points and reference objects
- the height difference between the EDM heights and the adopted mean levelled heights of all discrete marks, including BMs, PSMs, Instrument Stations and Quality Assurance Check Points are within the specified limits
- the height and positional differences between Quality Assurance Check Points common to successive instrument station set-ups are within the specified limits, and
- cadastral mark identification and real property descriptions as specified by the survey brief.

2.3.2.2 Digital data

In depth checks should be made on the supplied digital survey data. Supplied digital data should be loaded into a CAD system to enable various conformance checks to be made on the graphical output. Such checks would include, but not be restricted to, the following:

- correct use of approved plot feature codes with no unknown or illegal codes present
- all terrain data points individually surveyed and not artificially created using arcs or parallel offset techniques
- no single point line strings, crossing terrain strings or unusual heights outside the height range of the terrain data
- all terrain data points (all contourable points and all breaklines) are correctly grouped in the Terrain Model or layer
- closed boundary strings (BY) are supplied and correctly 'fit' both the edges of GFM data and any holes or gaps of unsurveyed or unrequired terrain data
- data correctly covers the band of interest as defined in the survey brief, with no unexpected holes or gaps
- sufficient cadastral marks located to allow positioning of property boundaries
- there is sufficient density of points for accurate GFM generation
- maximum specified terrain triangle sizes for both pavement and all other areas are not exceeded
- inspection of contours reveals no obvious peaks or holes to indicate isolated height errors (generate TIN from supplied terrain data)
- contours appear natural, 'fitting in' with featured detail, indicating correct application of breaklines and spot heights
- directional line strings have correct orientation, e.g., drain down strings traverse from higher point to lower point
- the minimum specified number of Quality Check Strings have been run and correctly placed through the terrain model
- height differences between any Quality Check String and interpolated levels generated along the Quality Check String from the TIN do not vary by more than that specified in the Standards or survey brief
- the model height of any discrete feature point does not differ from an independently levelled height value of that point by more than that specified in the Standards or survey brief
- the plan position of any discrete feature point does not differ from an independently measured position of that point by more than that specified in the Standards or survey brief
- invert levels of all drainage structures are recorded using the correct code, and
- text is relevant, suitable, and match MUTCD dimensions of infrastructure furniture and drainage structures.

2.3.2.3 Verification plot

In depth inspection of the verification plots would include, but not be restricted to, the following:

- a detailed examination of symbols and line styles used compared to comments in the processed data file (i.e., correct code used for each detail item)
- close scrutiny of contour plot for 'holes', possibly caused by accidental or deliberate deletion of long triangles – contours appear to represent a valid terrain model, and
- field inspection with verification plots where necessary to check for missing or incomplete data.

2.3.3 Audit level 3

In conjunction with the Audit Level 2, to check that the supplied survey data conforms to the Standards and to any variations contained in the survey brief, the audit should also include checks to assess the proficiency of the survey processes. Analysis of the various processes used and the principles applied by the Surveyor should be undertaken. Some of the process 'indicators' considered may include, but not be restricted to, the following:

- specific requirements of the survey brief or instruction are met
- the Surveyor's report confirms instructions have been followed or reasons given for variations
- the 'intent' of the survey (as stated in the survey brief or instruction) is met, e.g., the data is appropriate to the type of design required
- the Surveyor's report contains statements relevant to the 'reason' for the survey
- evidence of internal quality checks are contained in the delivered field notes, and
- full traceability is evident.

2.3.3.1 Survey book

The field notes should be examined to check the description, validity and presentation of the adopted datum. Attributes used could include, but not be restricted to, the following:

- concise definition of datum referred to a valid system
- 'traceability' of datum – evidence to show a clear path to the origin of the datum (cross-referencing)
- application of datum establishment principles – evidence of 'sound judgements' made
- best practice used in datum establishment:
 - e.g., a minimum of three points over the whole length of available marks (road survey – long thin band) or appropriate geometry/weighting of marks for datum establishment through resection, and
 - the adopted datum is appropriate to the project requirements.

2.3.3.2 Digital data

The processed data file should be checked to ensure the following conditions have been met:

- the 'flow' of data contained in the processed data file is contiguous, indicating smooth field operations

- there are occurrences of a minimum of one Reference Object (PROP) at each separate occupation of an instrument station to confirm adoption of correct azimuth
- the comments column in the data file contains remarks on detail that are relevant to the purpose of the survey
- independent level flights are continuous and include ties to all necessary instrument station and quality check data, indicating well planned field operations, and
- the use breaklines is appropriate for the definition of the terrain

2.3.3.3 Verification plot

Inspection of the verification plots would include, but not be restricted to, ensuring that:

- the contours are a good representation of the actual shape of the terrain (may require field inspection)
- the spacing of points is suitable to accurately define the shape of the features (e.g., the nose of a traffic island), and
- features and/or terrain are not poorly defined by insufficient detail or number of points, or defined by excessive detail or numbers of points.

2.3.4 Audit level 4

Audit Level 4 is a full field check of selected samples of the survey. Satisfactory results from the other audit levels would generally preclude the requirement for an Audit Level 4. Although an Audit Level 4 can be undertaken if desired or if it is part of District audit requirements. Regular random field audits are recommended.

Where unsatisfactory results are obtained from other audit levels, a decision must be made to either reject the survey data or continue with a Field Audit. If many checks have previously failed the audit, the survey data should be rejected and a nonconformance report generated. Where relatively few checks have failed or are in doubt, a Field Audit may be carried out to allay any doubts or confirm the audit results and a work improvement report generated.

The items checked in the field audit will depend on earlier audit results. Such checks may include, but not be restricted to:

- confirmation of height and or azimuth datums
- re-check traverse measurements – bearings and distances
- re-check heights of BMs, Instrument Stations and Quality Assurance Check Points
- visual checks of type and condition of datum marks
- random check on discrete detail points – position and height
- run random, independent quality strings through band of interest
- random checks on dimensions of both standard objects and selected structures or features
- random checks on invert levels of drainage structures
- visual walk through of job to confirm all features and sufficient terrain points located

- utilities and road furniture correctly identified, and
- survey monuments are in place and marked as identified.

The sample size for audit purposes will vary according to the quantum of non-compliance uncovered in the previous audit levels, but should be enough to quantify the confidence level required by the survey brief.

2.4 Construction surveys

A general requirement before commencing an audit for a construction project is to provide the Quality representative for the project with signed and dated copies of all current instrument calibration results for inclusion in the project records if requested.

The collimation of all instruments used in the audit should be checked frequently throughout the audit process. Records of each collimation check (including date) should be retained by the Audit Surveyor, to be produced on request to the Project Manager or his authorised representative. Results of any resections performed while auditing the project should be similarly retained.

The required accuracies of an audit will be dependent on the finished tolerance requirements for the various parts of a project as stipulated in either the Supplementary Specifications or Transport and Main Roads Specifications (MRTS and MRS) as applied to the particular project. Various parts of a project will have different audit accuracy requirements, depending on the various finished tolerance requirements.

2.4.1 Audit of project control stations

Details of the original survey marks and BMs that were placed and recorded during the pre-design survey will be shown on the scheme documents. Before the commencement of construction Works, the construction Contractor should advise the Principal of their agreement or, otherwise, to the validity of the documented values for these original marks.

The original survey marks and BMs should be used to establish Project Control Stations (sound survey marks from which all further construction processes are set out and/or checked) throughout the length of the proposed construction project.

Existing survey marks can also be used for Project Control Stations. However, any mark adopted as a Project Control Station (PCS) should be very stable, enabling it to accurately retain its lateral and height position throughout the project construction period. Only existing survey marks that have such stability should be considered for use as PCSs.

Both the Construction Surveyor and the Audit Surveyor may each establish separate Project Control Stations; however, in practice, it is preferable for both constructor and auditor to adopt the same PCS marks where possible. This will then enable the Auditor to either validate or invalidate the Constructor's values for the PCSs. Further auditing of a project is made easier if the Construction Surveyor and the Audit Surveyor can both agree on the co-ordinate and height values of each PCS.

2.4.1.1 Checks on survey marks

All original survey marks and BMs are subject to movement and, therefore, may not retain their original pre-design co-ordinate or height values. Plan co-ordinate and height values of any original mark can only be adopted following a rigorous check on the relationship between all original marks that are to be used to establish the Project Control Stations. The movement of existing marks may make it necessary to assign them new co-ordinate or height values.

Minor errors in the original pre-design survey or movement of existing marks may make it necessary to obtain a 'best fit' between the project co-ordinate values and the co-ordinate values of existing survey marks. This 'best fit' could be accomplished by a least squares adjustment or some other approved means. The effect of any such adjustment on the alignment with retained existing structures or clearances must be considered. In a 'best fit' of vertical control on pre-design Bench Mark values, analysis should be made of the impact on quantities, particularly in overlay type projects. For practical reasons, both the Construction Surveyor and Audit Surveyor should confer with each other when any such adjustments are found necessary.

Construction activities or geological conditions may cause movement of PCSs. During the entire construction period, regular check measurements between all PCSs are necessary to detect any movement. Once again, both Construction Surveyor and Audit Surveyor should confer where possible when assigning new co-ordinate values to a disturbed PCS or when establishing a new PCS.

Project Control Stations are the primary survey marks for a construction project, established to set out or check all other aspects of the project. Loss of PCSs can lead to costly job disruption. Wherever possible, they should be located clear of construction activities. They should be flagged in a way to make their appearance unique to other set out marks. All on-site job personnel should be instructed on the importance of protecting PCSs from disturbance.

2.4.1.2 Accuracy requirements

The required positional accuracies of a PCS must be dependent on the finished geometric tolerance requirements for the most accurate work item to be set out or checked from that PCS, e.g., a PCS placed to set out or check both a bridge structure and a pavement must meet the positional tolerance requirements for the bridge which would have the tighter tolerance specifications.

The need to attain finished tolerance requirements, together with inherent inaccuracies in measuring processes, means that the positional accuracy of a PCS must be better than the required finished geometric tolerances. Accuracy capabilities of the surveying equipment must also be considered, along with the required finished tolerances when calculating frequency and placement of PCSs.

The tight positional tolerances specified for common work items, such as kerb and channel and minor structures, means that for an average road project, horizontal co-ordinate accuracies for PCSs should be better than ± 10 mm. Where major structures are present, a range of ± 3 mm may be required.

Generally, specified vertical and cross fall tolerances for common work items, such as pavements and kerb and channel, means that for an average road project, height accuracies for PCSs should be better than ± 5 mm. Major structure tolerance requirements can reduce this to a height range of ± 3 mm. Tight vertical tolerance specifications mean that normal pre-design third order level accuracies are inadequate for setting out and checking most construction projects.

2.4.2 Audit of work items

Clear records, including date, of all audits for the location of work items must be kept and be produced on request to the Project Manager or his representative. Audit records should show all set up details, including instruments used, Project Control Stations occupied, any re-establishment calculations, co-ordinate values assigned and reference object observations. Location check observations and results must be recorded in an approved format, suitable for interpretation by others.

Checks for locations of most work items should be carried out directly from existing PCSs, where possible, or from temporary marks established using the existing PCSs or in the case of pavements, from Control Lines reinstated from the existing PCSs. Temporary marks could be established by resection from known marks with robust co-ordinates or some other approved surveying method. Measurements to a work item will produce the 'As Constructed' position of that item. Audit results are obtained by comparing the difference between this 'As Constructed' position and height of the work item with its plan position and height.

The finished geometric tolerance specifications for a work item must be kept in mind when auditing that work item. Observation measurement accuracies must reflect the tolerance requirements. Height observations should be obtained by properly calibrated level and staff if EDM observations will not attain the necessary height accuracy. Where a direct reading by EDM to a range pole on a work item is restricted by construction activity, appropriate calculations to adjust for offset readings should be taken.

2.4.2.1 Location checks on structures and road furniture

Checks for locations (general set out) are carried out from established project marks. It is necessary to ensure that set up details for the relevant marks, and reference objects sighted, are recorded. The locations of the relevant objects are then checked by comparing the measured XYZ co-ordinates to the plan co-ordinates. If direct measurement cannot be made (e.g., to a post), the reading should be taken beside the post and the horizontal angle adjusted to the centre of that post. Levels may be obtained by EDM readings, provided such methods supply results within the required standards of accuracy.

The method of displaying audit results for structure and road furniture work items will usually be as a direct comparison between plan and 'As Constructed' XYZ co-ordinate values. The Quality requirements for some projects, however, may necessitate the audit observations to be compared to differences in chainage and offset. Such cases require further processing of observations to allow the audit results to be calculated.

Bridge structures can provide the Audit Surveyor with problems in terms of accessibility to 'As Constructed' work items. Where possible, as construction progresses, project control should be transferred from the Project Control Stations to new PCSs along the bridge Control Line. As well as moving the auditor closer to the work items, this will also allow the use of a combination of EDM observations and measured offsets to audit the structure. Work items difficult to access may be located by careful radiation from two precisely located PCSs. Because of the very tight vertical finished geometric tolerances usual on bridge projects (generally ± 5 mm), height observations for bridge audits should be done using a properly calibrated level and staff. Where the structure of the bridge or surrounding terrain prevents a staff reading being observed directly on the surface an alternative method that can achieve the accuracy required may be used, e.g., direct EDM reading. The Surveyor may be required to prove the accuracy of that method if requested.

2.4.2.2 Accuracy requirements

The required accuracies of an audit on a structure or road furniture work item will be dependent on the finished geometric tolerance specification for that work item. Finished tolerances are stipulated in either the Supplementary Specifications or Transport and Main Roads Specifications (MRTS and MRS) as applied to the particular project.

Finished geometric tolerance requirements can vary from project-to-project. Therefore, the Auditor cannot assume tolerance requirements, but must check the specifications for each project. Common finished geometric tolerances for bridge structure items are: Horizontal ± 25 mm and Height ± 20 mm, for sub-structure and Horizontal ± 5 mm and Height ± 5 mm for super-structure. However, these tolerance requirements could vary to: Horizontal ± 3 mm and Height ± 1 mm.

2.4.2.3 Conformance to plans

The 'As Constructed' position of the structure or road furniture item should be recorded in the project file and the conformance to finished geometric tolerance specification or, otherwise, reported to the project's Quality Assurance (QA) representative.

2.4.3 Audit of earthwork volumes and stockpiles

2.4.3.1 Survey procedures

An accurate GFM of the original ground surface should be obtained from the PCSs by appropriate survey methods, prior to the commencement of construction. This will be the baseline GFM for subsequent audit measurements.

An accurate GFM of the stockpile / earthworks after placement of materials is performed. This second GFM is compared with the baseline GFM of the same area to determine volumes. For further placement, the second GFM is used as the subsequent baseline surface for further volume calculations.

2.4.3.2 Accuracy requirements

The accuracy requirements of the survey pick-up and GFMs will depend on both the specified geometric tolerances depending on the Supplementary Specifications or Transport and Main Roads Specifications (MRTS and MRS) as applied to the particular project and any specific request from the Project Manager. Before commencing the audit, the Audit Surveyor should consult the Project Manager as to what use is to be made with the audit information.

2.4.3.3 Processing of volumes data

The field audit data should be processed in an engineering CAD software package, e.g., 12D Model. Volumes are required to be calculated between the baseline GFM and the GFM of the new surface.

For quality assurance purposes, the volumes should be calculated using at least two different processes – usually by the direct 'tin to tin' method and, secondly, by the cross-section method. The volumes obtained by these two different processes should be compared. If they differ by less than 3%, the audited volume results should be acceptable. Re-processing of the volume calculations using closer cross section intervals should be tried if the volume results vary more than 3%. If re-processed volume variations between the two methods still remain higher than 3%, this may indicate that either the field audit work needs to be re-checked or that more check points need to be included in the terrain model.

2.4.3.4 Application of audit results

The resultant volume audit information could be used for checking either design volumes or volumes for progress payments. Expensive monetary payments to earthwork Contractors can be directly dependent on volume audit results. Care should be taken to assure that both the audit survey and volume calculations are within the specified accuracy required.

The results of the volume audit should be recorded in the relevant project file and reported to the Project Manager or project QA representative where necessary.

2.4.4 Audit of subgrade and pavement

All pavement layers from the trimming of the subgrade up to the finished pavement may be audited. Depending on the pavement design, this can involve the checking of many pavement layers over a single section of road.

2.4.4.1 Determining the audit method

The method of auditing a subgrade or pavement, as well as the frequency of checks, will usually be determined by the Project Manager. The Project Manager may specify audit by random points check or by cross-section.

The specified method could be, but not limited to:

- cross-sections at set chainage intervals over the entire project
- cross-sections at a set chainage interval over a specified lot
- cross-sections in random blocks throughout the entire project
- cross-sections in specified areas only
- levels at random points throughout a specified lot or the entire project, and
- differences between 'As Constructed' terrain model and design terrain model.

2.4.4.2 Survey procedures

Manual entry cross-sectioning

Manual cross-sectioning methods of auditing firstly require the reinstatement of the control line upon the pavement layer to be audited. Keeping in mind the finished geometric tolerance specifications for the pavement layer, the control line should be placed by EDM measurements from the existing PCSs, with a mark placed at each required chainage point.

Cross-sections should then be run left and right of each of these chainage marks along the control line, extending across the pavement layer. It is important to ensure that each cross-section is truly square or radial to the control line at that point.

Manual methods of cross-sectioning from a control line include:

- automatic level and staff, along with measuring tape, and
- electronic level and bar-coded staff, along with measuring tape.

EDME measurements

Cross-sections of a pavement can also be done using radiated EDM measurements from existing PCSs. These methods do not necessarily require the reinstatement of the control line. EDM methods are especially efficient if the design geometry of the control line and superelevation details are stored in digital format on board the EDM instrument.

A subgrade or pavement audit using differences between terrain models first requires a terrain model of the design pavement. This design terrain model is generated by triangulating a digital version of the design. Keeping in mind the finished geometric tolerance specifications for the pavement layer, an accurate capture of the current pavement layer by EDM pickup, with insertion of all necessary breaklines is then required for comparison to design. Random points or cross-section spot levels may also be compared with the digital terrain model to produce desired reports. Any terrain modelling should be undertaken using the project control stations as survey datum.

Accuracy requirements

The required accuracies of an audit on subgrade or a pavement layer will be dependent on the finished geometric tolerance specification for that work item. Finished tolerances are stipulated in either the project specifications or the particular Transport and Main Roads Specifications or any specific request from the Project Manager.

Finished geometric tolerance requirements can vary from project to project. Therefore, the Auditor cannot assume tolerance requirements, but must check the specifications for each project.

2.4.4.3 Processing of subgrade or pavement data

Clear records, including date, of all audits for subgrade or pavement layers must be kept and be produced on request to the Project Manager or his representative. Audit records should show all set up details, including instruments used, PCSs occupied, any re-establishment calculations, co-ordinate values assigned and reference object observations. All audit details must be recorded in an approved format, suitable for interpretation by others.

Where manual recording procedures are used, together with a level and staff, the field observations must be recorded in a field book, along with any calculations used to derive the results. The results should be transferred to a report for comparison to the design levels.

Where a computer software pavement auditing system is used together with a level and staff, a printout of the processed audit results will be available.

Where an electronic level or EDM is used, the values must be recorded on a computer printout. The results should either be transferred to a report for comparison to the design levels or downloaded into a spreadsheet for comparison to the design levels.

An audit of subgrade or a pavement layer by the comparison of differences between an 'As Constructed' terrain model of the layer and the design terrain model requires both terrain models to be processed in a suitable engineering CAD software package, e.g., 12D Model.

2.4.4.4 Application of results

The audit results are used for auditing conformance of the subgrade or pavement layer to the required geometric tolerance specifications. Apart from positional and height tolerance requirements, other geometric tolerances assessed from the audit include minimum and maximum layer thicknesses and minimum and maximum crossfall variations.

All audit results, including field book records and hardcopies of electronic outputs, must be retained for project records. The conformance or nonconformance to specifications, of each audit result, must be reported to the project's Quality Assurance (QA) representative.

2.4.5 'As Constructed' design plans

2.4.5.1 General

District procedures or the Project Manager may require 'As Constructed' design plans. These are usually restricted to structures, with emphasis on underground drainage and services. Audit records usually satisfy 'As Constructed' requirements for pavements.

2.4.5.2 Procedures

The data for compiling 'As Constructed' plans should be collected by normal auditing procedures throughout the construction period. No specific survey of completed pavement formation or structure is then required. Where original dimensions have changed, they are crossed out on a set of plans, with the new dimensions inserted (this is not generally done by the Surveyor, but by the QA representative on Site using the audit results submitted by the audit Surveyor). If required, 'As Constructed' details for pavements would be extracted from the pavement audits.

3 Aerial surveying

3.1 Introduction

3.1.1 Purpose

These specifications outline the department's requirements in obtaining aerial photography and the resultant photogrammetric imagery, plots and digital data necessary to fulfil a range of planning and design purposes.

3.1.2 Scope

These specifications cover the requirements for those aspects of aerial surveying used by the Queensland Department of Transport and Main Roads. It is intended that they provide direction in ascertaining the feasibility of using aerial surveying techniques for particular projects and assistance in defining requirements once the decision to use aerial surveying has been made. They also provide guidelines in carrying out the various tasks associated with aerial surveying.

3.1.3 References

- *Transport and Main Roads Surveying Standards*
- *Specifications for Vertical Aerial Photography*; Department of Resources
- *Supplementary Specifications for Aerial Photography*; Department of Transport and Main Roads
- *Guidelines for Flight Planning*; Department of Transport and Main Roads
- *Ground Control for Photogrammetry - Guidelines for laying Control Point Targets*; Department of Transport and Main Roads, and
- *Survey and Mapping Infrastructure Act 2003*

3.1.4 Air photo library

The department's existing aerial photography is stored in the Air Photo Library, which is administered and maintained by the Geospatial Technologies Section of Planning and Design Division. This library holds one set of prints and the film for all departmental photography and maintains the records for all the photography undertaken for the department.

3.1.5 Geospatial technologies

As well as administering the Air Photo Library, Geospatial Technologies is also responsible for the department's Annual Aerial Photography Programme and provides expertise in relation to all aerial photography and photogrammetry products and projects. References to Geospatial Technologies in this document refer, in particular, to its role as custodian of the Air Photo Library and departmental expertise.

It is not mandatory to consult Geospatial Technologies before undertaking an aerial surveying project. However, it is strongly recommended that expert advice is sought before commencing such a project as these Standards are by no means an instruction manual for undertaking that project. There are too many variables in relation to conditions, accuracies, costs, purposes for which the data is to be used, to adequately cover all aspects of aerial surveying in this document.

3.1.6 Definitions

The following definitions are to be used in the context of this document.

Aerial photography

The art, science, or process of taking photographs from an aerial platform.

Air photo scanned imagery – (raster image)

A digital image that can be stored on a computer. It is effectively continuous imagery comprised of a series of small picture elements (pixels). It is invariably captured by the scanning of hardcopy photography.

Aerial camera

A camera specially designed for use in aircraft.

Camera

A lightproof chamber or box in which the image of an exterior object is projected upon a sensitised film, through an opening equipped with a lens or lenses, shutter and variable aperture.

Diapositive

A coloured transparency directly produced on stable film from the aero-film negative, which is used as the data source in photogrammetric plotting machines and also as the source for scanning for image mosaics.

Ground and Feature Model (GFM)

A GFM is the result of systematically recording breaklines and spot heights from a stereomodel to create a Triangular Irregular Network (TIN) to represent the surface of the project area, as well as recording any observable features in the project area.

Fiducial marks

Index marks engraved on the camera film plate and which appear on the aerial film to enable photogrammetric orientation processes to be carried out.

Focal length

The distance from the image plane to the centre of the lens system of a camera.

Flying height

The vertical distance of an aircraft above the mean ground level of an area being photographed.

Flight line

A line or path drawn on a map or chart to represent the proposed track of the aircraft whilst capturing a run of photography.

Global Navigation Satellite System (GNSS)

GNSS is a satellite-based radio navigation system which enables determination of accurate three dimensional point position, velocity and time. The best known application of GNSS is the American Global Positioning System (GPS).

Orthorectification software

Digital photogrammetric software that accepts scanned stereo photography as input and produces imagery which is corrected for scale and distortion (ortho-rectified imagery / orthoimages) on which the GFM can be overlaid. Contour maps are the primary output.

Ground control

Existing or purpose-placed recognisable features appearing within the confines of the photography for the purpose of providing the relationships between the photography and true spatial position, and for which co-ordinates are known.

Orthorectification

An orthoimage (ortho-rectified image) that has had all distortions due to height differences removed from it. In effect, the orthorectification process produces an image that is true to scale.

Principal point

The principal point is defined as the point in the focal plane (film plane) where the line of the optical axis intersects the focal plane (the intersection of connecting lines between opposite fiducial marks).

Photo base length

The distance along the flight line between two Principal points of a stereoscopic pair of photographs.

Photogrammetry

The science or art of obtaining reliable measurements by means of photography. The result being the production of an accurate planimetric plot or map.

Aerial photogrammetry

Denotes that branch of photogrammetry wherein photographs of the terrain in an area are taken by a precision camera in an aircraft flying over the area.

Photogrammetric control point

A ground point, having known three-dimensional co-ordinates, which can be used to enable the solution of the space position and orientation of an aerial photographs.

Stereo overlap

When vertical photography is captured along a flight line, the photographs are exposed so that each successive frame overlaps part of the previous frame to permit stereoscopic visualisation.

Stereoscopic visualisation

The three-dimensional impression gained when viewing the same area in two overlapping photographs. One with the left eye and one with the right eye simultaneously.

TIFF file (.TIF)

A bitmapped image file in Tagged Image File Format.

3.2 Background

Aerial photography has been used as a planning, display and design tool for many years worldwide. Aerial photography is also an ideal base tool for use in the planning, design and maintenance of transport infrastructure.

Mosaics and photo enlargements can be used to show possible future developments when public consultation and display are required.

Computer scanned aerial photography imagery provides a flexible alternative to mosaics – the digital images can be rectified and additional digital data, such as the DCDB, proposed designs, etc., can be superimposed on these rectified images.

Photogrammetric surveys, plans and associated data can provide either a plot enabling a clear and concise appreciation of terrain or a digital terrain model for use in computer-aided design.

3.3 Aerial photography and products

For the purposes of this specification, aerial photography and its by-products may be divided into four broad categories, which are briefly described in this section.

1. Aerial photography – Aerial photography provides an excellent visual record of the department's roads and can be used in either planning, design or maintenance phases.
2. Digital imagery – Digital images obtained from aerial photography and produced in the form of strip mosaics or frames provide an extremely versatile format for planning or presentation purposes.
3. Digital surveying data – Digital surveying data has become more frequently used by planners and designers to form the terrain model necessary in road planning and design processes. One source of this digital data is photogrammetric modelling derived from aerial photography.
4. Existing products – The availability of existing aerial photography, topographic mapping and cadastral mapping is covered in this section.

3.4 Aerial photography

Aerial photography provides an excellent visual record of the department's roads, and can be used in either planning, design or maintenance phases. The procedures required for general or project-specific air photography capture are covered in this section.

Colour vertical aerial photography captured in runs along the road centreline or in parallel runs over the project area is the normal end product. This photography is in the form of overlapping photographs that enable the road / area to be viewed stereoscopically.

3.4.1 Defining requirements

If existing aerial photography is unsuitable for a project requirement, particularly where large scale photographs are indicated, project-specific photography will need to be captured.

Consultation in planning such projects should be held with the Principal Surveyor, Geospatial Technologies, who will then co-ordinate the capture of the photography and supply of colour prints.

3.4.2 Purposes of aerial photography

Aerial photography can be captured for a number of purposes:

- route investigation
- preliminary planning and location for upgrades and/or maintenance
- record of road assets and/or conditions, and
- production of image mosaics and/or photogrammetry.

3.4.3 Factors to be assessed

The following factors should be considered when requesting aerial photography:

- Is the photography required for investigation, location or presentation?
- Is suitable existing aerial photography coverage available?
- How large is the area to be covered?
- What scale is most suitable to satisfy the requirement?
- Could the photography be used for future additional purposes (photogrammetry / imagery)?
- Is there a time frame to be complied with?

3.4.4 Aerial photography specifications

Generally, the specifications for the capture of aerial photography, photography prints, etc., shall be as set down by the DoR in its specifications for Vertical Aerial Photography. In addition, the requirements of the department's Supplementary Specifications for Aerial Photography will also apply, as will the relevant requirements of the *Survey and Mapping Infrastructure Act 2003* and its regulation.

Colour film is now generally used for all photographic requirements; however, black and white film may be used for special purposes.

3.4.5 Project execution

Once the requirements have been defined, the tasks necessary to achieve the required outcomes can be initiated. Aerial photography projects may be divided into the following stages:

1. Flight planning.
2. Capture of aerial photography.
3. Verification of photography captured.
4. Delivery of prints and flight line data.

3.4.5.1 Flight planning

A corridor of interest will be nominated by the office requiring the information. Whether the flight lines are to be designed by Geospatial Technologies, as a consultant, or locally, the following objectives should be aimed for.

In general, scales of 1:3000 and 1:7500 have been adopted for general record or material selection purposes.

In planning flight lines, provision should be made for forward overlaps of 60% and where parallel runs are involved, a side overlap of 30%.

Table 3.4.5.1 – Guide for identification and coverage

Guide for identification and coverage purposes			
Photo scale	Coverage of single photo km	Distance between exposes (60% overlap) km	Distance between flight lines (30% overlap) km
1:3000	0.69	0.28	0.48
1:5000	1.25	0.46	0.80
1:7500	1.725	0.69	1.21
1:10000	2.30	0.92	1.61
1:15000	3.45	1.38	2.41

Notwithstanding the requirement for the stereoscopic overlaps given in Table 3.4.5.1, the band of interest on the photographs is to be the central 60% of the width of the frame to minimise the distortion of the detail. That is, the features should not lie within the outside 20% of the frame.

Figure 3.4.5.1 – Direction of flight

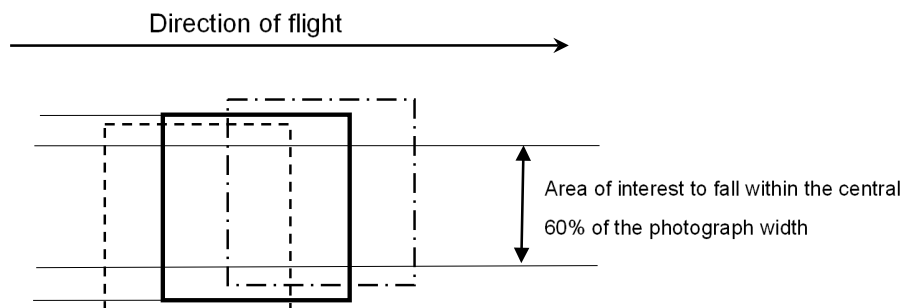

Flight line maps

In sparsely settled areas of the state, topographic maps are generally favoured as they show the type of information (natural features) easily identified from the air.

In the more developed, and highly developed areas, suitably scaled maps, showing boundaries, streets and roads are preferred. Generally speaking, the lower the flying height, the larger the map scale required.

As a general rule, where practical, flight lines should be prepared on a map of a scale approximately 10 times that of the proposed photography.

The roads should be marked as a black line with any contemplated deviations shown as a broken line.

Each flight line should be kept straight and of maximum reasonable length. They should be located such that the area of interest on the ground, when photographed, will fall within a middle band width of 60% of the photograph (see previous diagram).

Runs should be numbered consecutively.

To ensure ample coverage in rough mountainous areas, the area of interest should fit within the central 50% of the photograph.

The photographic coverage of the centre of the first and last photo should extend one photo base length beyond the limits of the area of interest or the intersection of flight lines.

Suitable overlapping of approximately parallel contiguous runs may often avoid a short intermediate flight to cover a kink in the route.

The optimum position for flight lines can be quickly ascertained if transparent templates are made (for the scale of the base map) showing the ground width of photography.

3.4.5.2 Air photography schedule

In addition to the flight maps showing the proposed flight lines, the requirements are to be listed on an Air Photography Schedule.

Each road / area over which photography is required shall be assigned an Item No. in the schedule and is prefixed with the District No.

Example:

11/1 for District 11 Item 1

The mean ground level for each run should be determined and entered in the schedule.

On the flight line map, the District / Item No. should be shown adjacent to each road or project area and circled.

Ground control

The location of ground control points will need to be determined for the purpose of obtaining the relationships between the photography and true spatial position.

The location and density of the ground control will depend upon the purpose for which the photography is to be used. These specific requirements will be addressed in the relevant sections.

3.4.5.3 Capture of aerial photography

Once the flight planning has been completed, a contract is let to capture the photography in line with the normal Transport and Main Roads quotation processes. The selected consultant is then responsible to ensure that the photography is captured and delivered within the time constraints imposed by the client's requirements. The capture is dependent upon the correct weather conditions and it will be necessary for the Project Manager to be kept apprised of any delays in expected delivery.

3.4.5.4 Verification of photography captured

Once the photography is flown and the film developed, a set of prints is forwarded by the consultant for checking. These checks are to verify that the photography captured meets the project requirements as set out in the quotation brief. These checks will include:

- the title strip information is correct
- the capture covers the required area as set out in the flight plans
- the photography has been captured at the correct scale
- the required overlap has been obtained

- cloud, or shadow from cloud, does not obscure terrain or features within the area of interest (ideally, there is an absence of cloud), and
- the colour of the photography is suitable.

3.4.5.5 Delivery of prints and flight line data

Prints supplied

Two sets of prints are normally supplied for general air photography projects. With one set for the client and one set for the Air Photo Library maintained by Geospatial Technologies.

Three sets of prints are to be supplied to the department for photogrammetric projects, with the following distribution: one set to the client, one set to the Air Photo Library and the third set to the photogrammetrist for use as the mapping control set. The prints are to comply with Transport and Main Roads - *Supplementary Specifications for Aerial Photography*.

Flight line data

GNSS data for each photo centre (Principal point) is to be provided in accordance with DoR specifications and Transport and Main Roads - *Supplementary Specifications for Aerial Photography*. Basically, the data is to contain the photography title strip information, as well as geographical and grid co-ordinate values for each photo centre.

Film negative

The film presented at the completion of the project should contain only Transport and Main Roads photography. The film is to have an appropriate Leader and Film Report attached and the film canister correctly marked.

3.5 Digital imagery from aerial photography

Digital images obtained from aerial photography and produced in the form of strip mosaics or frames, provide an extremely versatile format for planning or presentation purposes. Additional digital data is easily superimposed over the base image.

This involves scanning the photography, then performing photogrammetric tasks on a computer, without using hardcopy photographs during the actual process. The result can be a digital terrain model and/or orthorectified images.

3.5.1 Defining requirements

3.5.1.1 Purposes of air photography imagery

Imagery can be produced for the following purposes:

- public display / presentation
- route investigation
- preliminary planning and location
- base for DCDB or similar overlays
- evidence for legal actions
- consultation
- design

- monitoring, and
- recording existing features or situations.

3.5.1.2 Factors to be assessed

The following factors should be considered when requesting Imagery:

- Is the information required for investigation, location or presentation?
- Is suitable aerial photography coverage available?
- At what scale is the end product required?
- What quality of image is required?
- Will scanning from prints suffice?
- Is scanning from diapositives necessary?
- Is rectification required?
- If orthorectification is required
- Is existing control sufficient / available?
- What is new control requirement?
- Would digital control suffice (DCDB, GFM)?
- What overlays are required?
- What end products are required?
- What hardware / software capability is required?

A model produced from a single photo frame scanned at 24 microns produces a .tiff file, approximately 270 Mb in size.

Table 3.5.1.2 – Guide for image resolution

Guide for image resolution purposes		
Photo scale	Coverage across flight line	Pixel size (on ground) @ 24 micron scan
1:3000	690 m	0.072 m
1:5000	1150 m	0.120 m
1:7500	1730 m	0.180 m
1:10000	2300 m	0.240 m
1:15000	3450 m	0.360 m

3.5.1.3 Imagery versus mosaics

Imagery has some significant advantages over conventional air photography enlargements or mosaics.

Advantages include:

- if the image is orthorectified, the resultant product is true to scale

- a digital image can have layers of digital data superimposed over the image
- colour matching between models is more consistent
- production time is less
- multiple copies are available at the push of a button, and
- a non-rectified image can be approximately matched to the DCDB.

Disadvantages include:

- time delay in establishing control for rectification
- processing time, and
- client's hardware / software capability.

3.5.1.4 Products of air photography imagery

- Diapositives of aerial photography and contact prints.
- Scaled / orthorectified image data.
- Scanned single frame image.

3.5.2 Project execution

If existing aerial photography is unsuitable for the project requirement, particularly where large scale or up-to-date photographs are required, project-specific photography will need to be captured.

The procurement of the necessary aerial photography, ground control if required, diapositives and image production will be co-ordinated by the Principal Surveyor, Geospatial Technologies.

It is strongly recommended that any aerial photo imagery requirement / planning be carried out in close consultation with Geospatial Technologies prior to submitting the request.

3.5.2.1 Stages of a project

Air photo imagery projects may be divided into the following stages:

- flight planning
- targeting and ground control survey (if required)
- capture and verification of aerial photography, and
- processing / data production.

3.5.2.2 Flight planning

In general, the air photography requirements as outlined in Section 3.4 of this document apply. However, additional considerations as identified in this section must also be taken into account in planning for digital imagery purposes.

3.5.2.3 Targeting and ground control for imagery

If the required imagery is to be orthorectified, then horizontal and vertical control will be needed. If, in accordance with the assessment made at Section 3.5.1.2 of this document, above, new control is required, then depending upon the terrain, development and vegetation conditions over the project area, the control can be established either:

- Prior to aerial photography, when horizontal and vertical control points are chosen from ground features, which it is considered will be identifiable on the photography to be flown. If no ground features can be identified, suitable points are pre-marked and targeted immediately prior to photography, known as 'pre-control'.
- After aerial photography, when the horizontal and vertical control points are chosen from features on the ground, such as fence corners, which can be identified on the photographs, known as 'post-control'.

If existing control is to be used, this will be obtained and incorporated at the production stage.

Number and location of photo control points

The orthorectification software enables an aerotriangulation type block adjustment to be carried out on a run-by-run basis. This facility means that fewer control points will need to be established. Close consultation with Geospatial Technologies will clarify this requirement.

Selection of photo control points

Subject to the requirements as identified in the previous section, the selection, planning, establishment and targeting of the required control points will generally be in accordance with the requirements above.

3.5.2.4 Capture and verification of aerial photography

Once the flight planning has been completed, a contract is let to capture the photography, in line with the normal Transport and Main Roads quotation processes. The selected consultant is then responsible to ensure that the photography is captured and delivered within the time constraints imposed by the client's requirements. The capture is dependent upon the correct weather conditions and it will be necessary for the Project Manager to be kept informed of any delays in expected delivery.

Verification

Once the photography is flown and the film developed, a set of prints is forwarded by the consultant for checking. These checks are to verify the photography captured meets the project requirements as set out in the quotation brief. These checks will include:

- the title strip information is correct
- the capture covers the required area as set out in the flight plans
- the photography has been captured at the correct scale
- the required overlap has been obtained
- cloud, or shadow from cloud, does not obscure terrain or features within the area of interest (ideally, there is an absence of cloud), and
- the colour of the photography is suitable.

3.5.2.5 Processing / data production

The methodology used for the production of images / mosaics, imagery block adjustment and/or use of existing control for the production of a digital data image will be such that the information and accuracy requirements specified by the department are satisfied.

Scanning

Scanning of aerial photography can be done from either the film negative, diapositive or contact print, and can be carried at a rate to suit the specific requirement. High resolution scans should only use the film negative or a diapositive as the source material. The resultant approximate .tiff file sizes are, for example, at: 24 microns—270 Mb, at: 14 microns—371 Mb. Scanning of contact prints should only be used for small areas or frames not requiring large magnification.

Images

The images supplied can be:

- non-rectified – processed by a combination of scaling and specific software packages to give approximate relative positioning, and
- rectified – processed by specific software packages to remove all distortions and present ground accurate metric images.

Deliverables

All digital data will be as per survey brief.

3.6 Digital surveying data from photogrammetry

Digital surveying data has become more frequently used by planners and designers to form the terrain model necessary in road planning and design processes. A source of digital data for such models is photogrammetric modelling derived from aerial photography.

Topographic plotting and terrain modelling can be produced by field survey or by photogrammetry. In many cases, a combination of both techniques will give the best result.

3.6.1 Defining requirements

3.6.1.1 Purposes of photogrammetric surveys

Photogrammetric surveys are undertaken for the following purposes:

- route investigation
- location and design
- catchment areas
- landslips
- production of digital terrain models
- base for DCDB overlays
- progress payments, and
- volume calculations.

3.6.1.2 Factors to be assessed

The following factors should be considered when requesting photogrammetric surveys:

- Is the information required for investigation, location or design?
- Is suitable aerial photography coverage available?
- Is the ground concealed by dense vegetation cover or by long grass?
- Is a digital terrain model required?
- Is a cadastral overlay required?
- To what extent is cultural (man-made) detail required to be shown?
- What plotting scale will show topographic detail to the best advantage?
- What contour interval and spot height accuracy are required?

Table 3.6.1.2 – Guide for accuracy and coverage

Guide for accuracy and coverage purposes				
Photo scale	Coverage across flight line	Horiz./vert. accuracy	Contour interval (GFM derived)	Recommended usage
1:3000	690 m	0.100 m	0.25 m	Design
1:5000	1150 m	0.120 m	0.5 m	Planning / Rural Design
1:7500	1730 m	0.175 m	1.0 m	Planning
1:10000	2300 m	0.250 m	1.0 m	Planning
1:15000	3450 m	0.350 m	2.0 m	Planning

Note:

The horizontal / vertical accuracies as quoted are only achievable on hard clear surfaces, with no error allowance in the ground control.

The contour interval accuracy as stated is that which is deemed achievable over clear and consistent terrain conditions and is derived from the spot heights grid.

3.6.1.3 Photogrammetry versus field survey

In determining the relative merits of photogrammetry over field surveys, the following advantages and disadvantages of photogrammetry should be considered:

- Advantages include:
 - large areas, especially where the strip of land to be covered is wide
 - mountainous country
 - areas with difficult access, and
 - politically-sensitive areas where plans can be produced with a minimum disturbance to property owners.

Disadvantages include:

- delays can occur if new aerial photography has to be obtained. Aerial photography missions are controlled by the seasons and the weather

- long grass, trees, other vegetation, structures and water may obscure the ground
- inaccuracies in obtuse, but critical, areas, such as long / low cuts, long / low fills or cut / fill lines, and
- may need field completion to locate such features as:
 - cadastral marks
 - bed levels
 - underground services, e.g., gas, sewerage, etc, and
 - drainage details, e.g., pipe size.

3.6.1.4 Products of photogrammetric surveys

The products resulting from this procedure are:

- prints of aerial photographs
- diapositives
- ground control surveys
- ground and feature models
- verification plots
- contour and/or spot height overlays to plans, and
- digital terrain information.

3.6.2 Project execution

3.6.2.1 Request for photogrammetry

Standard mapping coverage photography is often unsuitable for the department's work, particularly where plans at large scale are required. The contour interval and height accuracy required on engineering Works is not often attained in mapping and, therefore, project-specific photogrammetric surveys will be necessary.

Requests for photogrammetry should be forwarded to the Principal Surveyor, Geospatial Technologies.

The procurement of the necessary aerial photography, ground control, photogrammetric plotting and terrain modelling will be co-ordinated by the Principal Surveyor, Geospatial Technologies.

Flight planning, pre-targeting, ground control surveys and photogrammetry are stages which will influence photogrammetric procedures and accuracies. Hence these stages should be planned in close consultation with Geospatial Technologies.

Photogrammetric projects may be divided into the following stages:

1. Flight planning.
2. Targeting.
3. Ground control surveys.
4. Capture and verification of photography.

5. Photogrammetry.
6. Field completion.

3.6.3 Flight planning for photogrammetry

In general, the air photography requirements as outlined in Section 3 of this document apply. However, additional considerations as identified in this section must also be taken into account in planning for photogrammetry purposes.

3.6.4 Targeting

For precise photogrammetric work, both the positive identification of, and the accuracy of observation on, ground control targets are vital. The costs of field survey, photographic flying, aerial triangulation, photogrammetric plotting and/or the collation by photogrammetric methods of digital terrain data are considerable. Uncertainties or errors either in identification of, or observation on, target points can be costly, time consuming and have adverse effects of resultant accuracies.

The main elements of good target design are:

- good colour contrast in relation to the background
- the target size must yield a satisfactory image on the photographs, and
- the target must be symmetrical and centred on the station.

3.6.4.1 Artificial targets

Artificial targets placed prior to capture of the aerial photography generally provide the best possible photographic images. They also have the advantage of excellent image quality (provided that the target is well designed) and the unique appearance of the artificial target minimises the possibility of misidentification by the photogrammetrist.

Nevertheless, some disadvantages of artificial targets are:

- Some extra expense may be incurred in having to obtain suitable materials for the targets and place the targets in position.
- This extra expense will be directly related to whether or not it would be simpler to identify a natural feature, if such a feature is available. Also in very 'difficult' country, where identification of natural features would involve maybe one or two days attempting to produce a suitable identification, the artificial target could be placed more quickly, despite the fact that considerable clearing may be necessary.
- The targets need to be regularly maintained since, depending on the materials used, they are subject to disturbance by weather, animals and people.
- This disadvantage occurs more frequently than one might expect, i.e., that targets are subject to disturbance and, therefore, unless the aerial photography can be completed within a short time after the targets are placed, a maintenance program is required. Under these conditions, targeting is best carried out in relatively small accessible areas. Maintenance of a large number of targets is difficult and in remote areas, may even be impractical.
- The targets may not be in favourable locations on the photography.
- This disadvantage is largely overcome by positioning the targets in relation to the coverage of the photography as specified in the flight plan.

3.6.4.2 Existing feature targets

Existing features, either natural or man-made objects, may be utilised as targets. The following are suggested, depending on the scale of photography:

- annulus or white circles or crosses painted on bitumen roads
- old car or truck tires – painted flat white (large scale photography only)
- painted manhole covers (large scale photos)
- a circle of rocks or logs painted white
- a circular trench cut into the ground to form an annulus – the spoil being formed into a mound around the edges of the trench. Generally, such a target is more suitable for open country
- logs from which the bark has been stripped and the timber painted flat white, and laid out in the form of a '+', 'T' or 'Y', and
- rocks or stones painted white and laid out in a similar manner to above.

3.6.4.3 Patterns and design of targets

Contrast with background

Contrast with background may be achieved either with light toned target against a darker toned background or vice versa. Contrast may also be achieved or enhanced by differences in texture.

Symmetry of targets

The accuracy of observations on image points is enhanced if those image points display a symmetrical pattern centred on the particular point in the terrain which they are intended to signalise. Such symmetry is at least as important as shape and size in the design of targets.

Geometrical patterns

Numerous arrangements of distinctive geometrical patterns can be used for targets. The simplest patterns are square, circular or equilateral triangular in shape. More complex patterns may be symmetrical crosses, checkerboard patterns or Y-patterns.

Colours providing contrast

For maximum contrast, it is unlikely that a better choice could be made than white on black. However, yellow also provides good contrast with most backgrounds.

Composition and material of targets

When materials are used, contrast is best obtained using, say, white or yellow non-reflective plastic sheeting against a black or dark background. Dark coloured earth or rocks, or green turf, provide an excellent background.

Of the many synthetic materials available, white or yellow opaque polyethylene film is an excellent target material. Unbleached white muslin or bleached cotton sheeting (produce bags) also make good target material. Plywood or similar materials (core flute), suitably painted, also make good target materials.

Glossy finished materials should be avoided for either target or background material because its high reflectivity may destroy photographic images.

Location and siting of targets

The optimum site for a target will be found where the terrain is as flat as possible, so that the level will not vary greatly over the target area. It is desirable for the site of the target to be unobstructed within a 45° cone with a zenith axis. Where obstructions, such as vegetation, occur within such a cone, clearing will generally be necessary. When targets are placed in small clearings in brush covered or wooded areas, care must be taken to see that the target is in full sunlight during the hours suitable for aerial photography.

Effective dimensions of targets

The most suitable targets are generally designed in the form of a '+' a 'T' or a 'Y', symmetrically located about the station.

The inner end of the leg panel should be set back from the station – mark a distance equal to the width of the leg panel.

When a black target is used on a white background, irradiation effects (image spread) cause the image of the black target to be smaller than usual, consequently target dimensions need to be increased by 1.5 to 2 times to allow for this effect.

Figure 3.6.4 – Ground control targets for photogrammetry

GROUND CONTROL FOR PHOTOGRAMMETRY

GUIDELINES FOR TARGET DIMENSIONS

(Not to scale)

UP TO 1 : 4,000 SCALE PHOTOGRAPHY

Dimensions:

e.g.-

At photo scale 1:4000:
 $D = 0.04 \times 4000 = 160 \text{ mm}$
 $P = D \times 3 = 480 \text{ mm}$

For other scales multiply:

$D = 0.04 \times \text{scale no.}$
 $P = D \times 3$

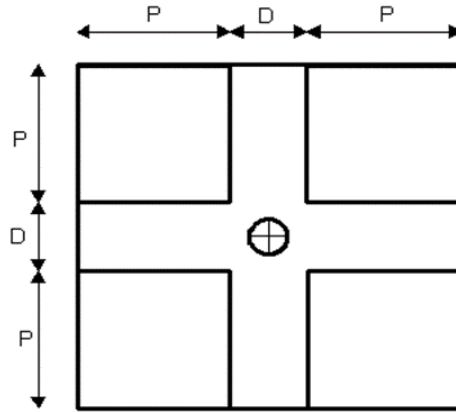

OVER 1 : 4,000 SCALE PHOTOGRAPHY

Dimensions:

e.g.-

At photo scale 1:7500:
 $D = 0.05 \times 7500 = 375 \text{ mm}$
 $P = D \times 5 = 1875 \text{ mm}$
 $S = D$

For other scales multiply:

$D = 0.05 \times \text{scale no.}$
 $P = D \times 5$
 $S = D$

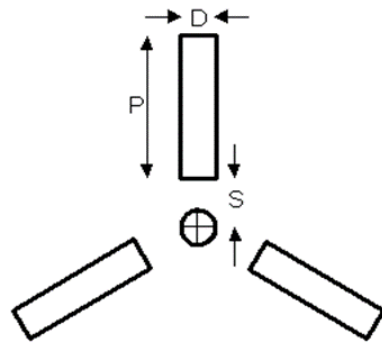

Page J -

3.6.4.4 Target site clearing

Target sites should ideally be flat and cleared such that all obstructions above 45 degrees are removed. If a suitable flat Site cannot be found within the target polygon, a Site with a constant grade as close to flat as possible may be selected.

When positioning a target in a tight space, it is helpful to associate the planned flightline in relation to the Site. The target may be able to partially offset to the side of the clearing away from the flightline to help minimise the potential of unmovable obstructions blocking the line of sight from flightline to target.

Always consider the potential of shadows covering the target when assessing where to place the target.

Figure 3.6.6.4 – Target site clearing

TARGET SITE CLEARING

SELECTION OF PHOTO CONTROL POINTS AND TARGET SITES - CLEARING

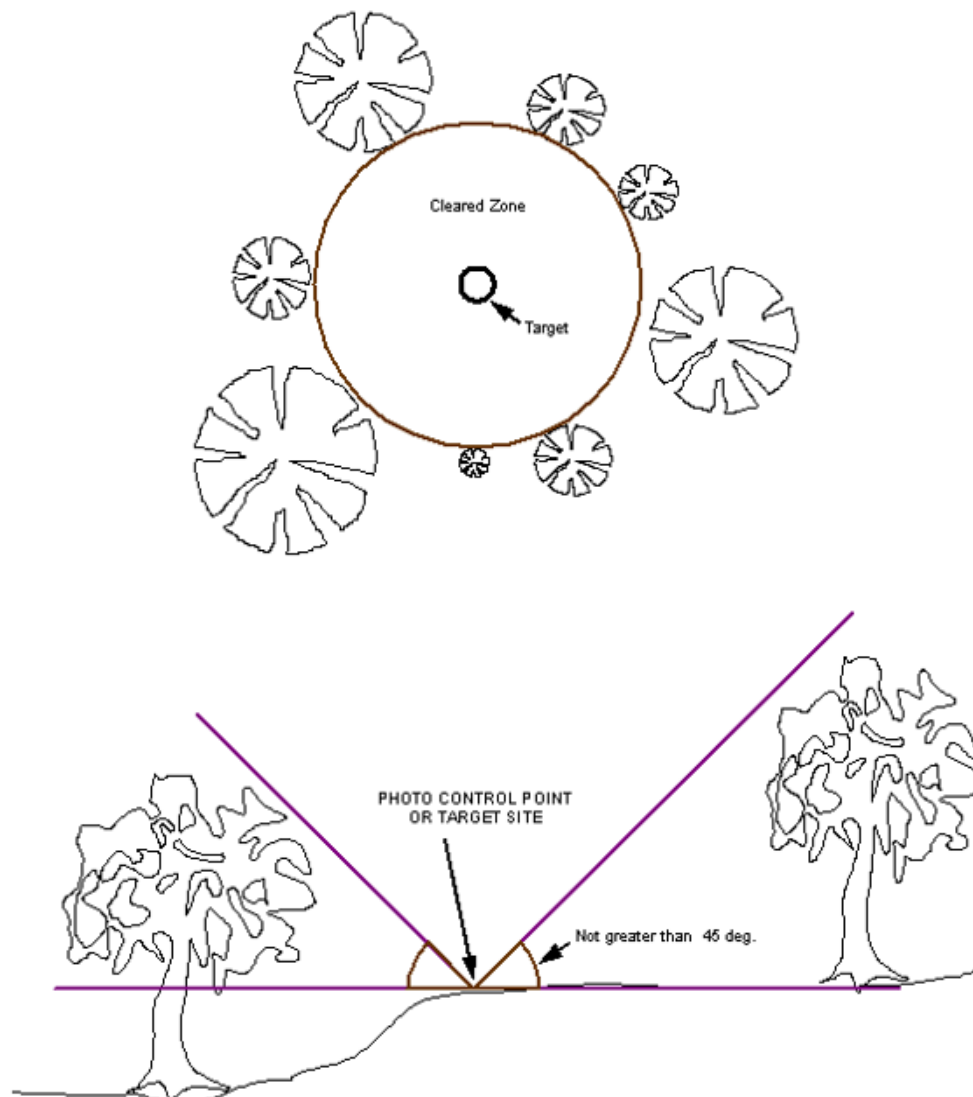

3.6.5 Ground control

Ground control surveys are required to supply horizontal and vertical control points for photogrammetry.

It may be necessary to use existing imagery for photogrammetry or it may be inconvenient to position targets prior to the imagery being taken. In such cases, the targeting may be done after the imagery has been flown. Unique and unambiguous features can be selected from the new images and located by survey to the required accuracy and used for control.

The ground control survey may be carried out:

- prior to aerial photography, when horizontal and vertical control points are chosen from ground features, which it is considered will be identifiable on the photography to be flown. If no ground features can be identified, suitable points are pre-marked and targeted immediately prior to photography.
- after aerial photography, when the horizontal and vertical control points are chosen from features on the ground, such as fence corners, which can be identified on the photographs.

3.6.5.1 Number and location of photo control points

As the use of the Global Navigation Satellite System (GNSS) is now accepted as the best method of establishing control points for photogrammetry, horizontal and vertical values are provided at every point established.

In most cases, Transport and Main Roads photogrammetry is produced from single runs of photography, with multiple runs overlapping at the ends of the runs. Control points are required at the end of each run and at about every three models in between and located in the standard positions as much as possible. The control points at the end of a run should appear in the overlapping run as common points.

Figure 3.6.5.1 – Standard positions in a stereo model

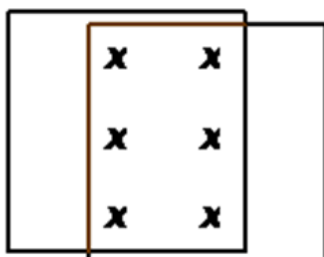

Where a project consists of parallel runs of photography, the control points should also appear in the side-overlaps of the adjoining runs.

In every instance, reference should be made to the photogrammetrist for verification of the location of photo points particularly where the areas to be mapped are irregular in shape or where the terrain and/or vegetation severely hamper identification.

3.6.5.2 Selection of photo control points

For road design location purposes, it is seldom necessary to map a whole model area. Usually, a narrow band of interest may be defined, in which case the positioning of ground control points may be modified as follows:

- the outer control points should fall outside the band of interest, so as to retain the accuracy and integrity of the digital data within the perimeter of the control points
- each row of points across the flight line should be perpendicular to the flight line as much as possible or at least fall within the one model, and
- it may be necessary to select additional points to balance the 'control figure' in some cases.

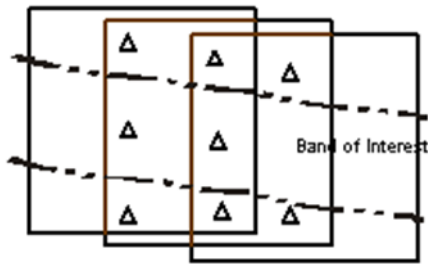
Figure 3.6.5.2 – Control point positions

The initial selection of points may be made in an office, but the adoption of those points will depend upon the Surveyor's opinion of their suitability on the ground.

Current practice using aerotriangulation requires fewer control points than indicated by the classic positions. Generally, two control points every three models will suffice, but this will be dictated by individual circumstances.

3.6.5.3 Planning photo control requirements

Irrespective of the method chosen, the principles of determining the number and location of suitable photo control points are still applied. Usually, a suitably scaled topographic map sheet is obtained and the proposed photography flight lines and photo control positions are selected.

Based on the flying height of the proposed photography and the anticipated flight lines, it is possible to determine the areas of minimum side and end overlap within each run of photos. Once these 'minimum' parameters are determined it is possible to delineate on the topographic map, an area within which each proposed photo control point must fall. The topographic base map, showing these areas can then be supplied to the Surveyor who must select suitable photo control points within the 'areas' shown on the map. A further advantage may be obtained by showing these areas on any recent existing aerial photographs, thereby providing a 'locality diagram', which may assist the field Surveyor in selecting a suitable photo control point position.

Note: No point should be within 10% of the edge of any photograph on which it appears.

3.6.5.4 Ground control surveys

The Project Reference Frame should be established across the project site to provide the framework for all subsequent survey work. The position of ground control should subsequently be determined from the Project Reference Frame.

Accuracy of control surveys

As mentioned previously, the use of the GNSS is accepted as the best method of establishing control points for photogrammetry. The preferred method is a least squares adjusted Fast Static network.

Co-ordinates obtained using standard GNSS - RTK methods will provide suitable accuracy for photogrammetric requirements. The ground control accuracy shall be no worse than 1/3 of the accuracy required from the photogrammetry. For 1:3,000 scale aerial photography has an accuracy requirements of 100 mm, therefore the ground control should be within + 0.033 m.

The ground control survey shall feature:

- sufficient redundancy

- independent occupations on each mark with at least 30 minutes between observations
- RTK observations will be averaged to derive the final position, and
- Fast Static networks will be adjusted by least squares.

In cases where the area of interest is a narrow corridor, additional control with accurate heights can be placed in the corridor (one control point per model) to improve the accuracy of the aerotriangulation rather than accurately level the control points on the extremities of the photography.

Co-ordinate system

The department's stated datum (refer Section 5 of *Part 1 – General Information*) shall be used unless specified otherwise in the survey brief.

Point identification

Ground control points are to be numbered in accordance with the following conventions:

- horizontal and vertical – prefix with a 7
- horizontal only – prefix with a 6, and
- vertical only – prefix with a 5.

A sketch is to be provided for each ground control point. The sketch, which is an aid to the photogrammetrist, should show the target or feature and adjacent identified features in their correct positional relationship to one another.

Figure 3.6.5.4 – Ground control data sheet

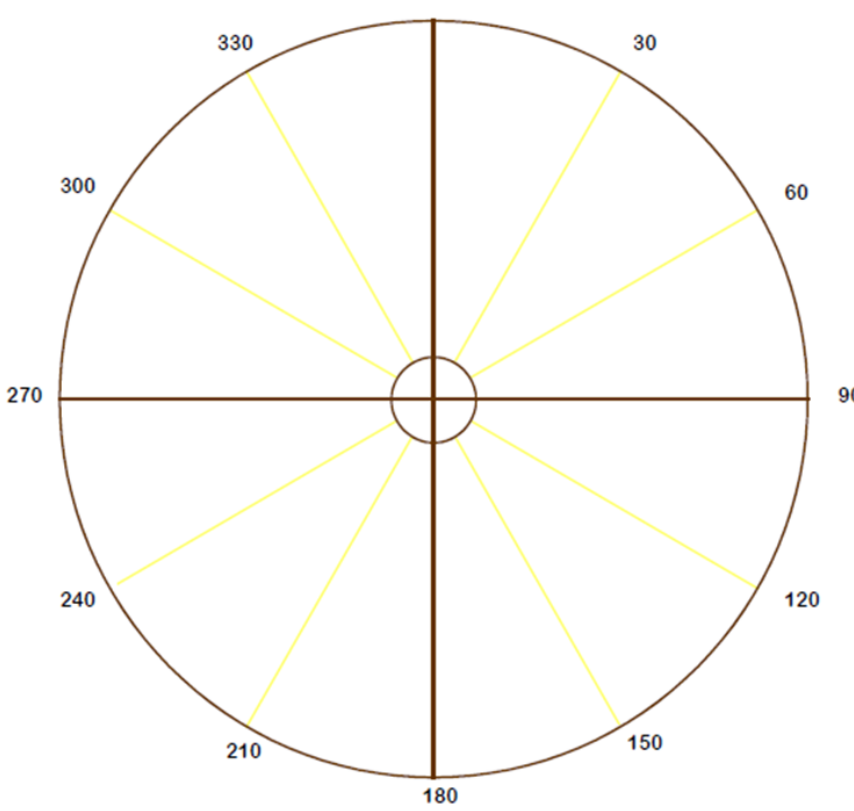
<p>Ground Control Point Data</p> <p>Ground Control Point Name : _____</p> <p>Description : _____ _____ _____</p> <p>Co-ordinates of Ground Control Point :</p> <p>X : _____ Y : _____ Z : _____</p> <p>Co-ordinate Datum _____</p> <p>Horizontal : _____ _____ _____</p> <p>Vertical : _____ _____ _____</p> <p>Check List :</p> <table style="width: 100%;"> <tr> <td><input type="checkbox"/> GCP Named</td> <td><input type="checkbox"/> Target size & shape notes</td> </tr> <tr> <td><input type="checkbox"/> Point described</td> <td><input type="checkbox"/> Photo marked & numbered - also on back</td> </tr> <tr> <td><input type="checkbox"/> Co-ordinates checked</td> <td><input type="checkbox"/> Notations below sketch completed</td> </tr> <tr> <td><input type="checkbox"/> All points plotted with distances shown</td> <td></td> </tr> </table> <p>Signature: _____ Date: _____</p>	<input type="checkbox"/> GCP Named	<input type="checkbox"/> Target size & shape notes	<input type="checkbox"/> Point described	<input type="checkbox"/> Photo marked & numbered - also on back	<input type="checkbox"/> Co-ordinates checked	<input type="checkbox"/> Notations below sketch completed	<input type="checkbox"/> All points plotted with distances shown		<div style="text-align: right;">  </div> <p style="text-align: center;">Ground Control Sketch</p> <div style="text-align: center;">  </div> <p>Project: _____</p> <p>Photo No: _____ Run No: _____ Film No: _____ Photo Scale: 1: _____</p> <p>Bearings magnetic Yes <input type="checkbox"/> No <input type="checkbox"/> Recorded By: _____</p>
<input type="checkbox"/> GCP Named	<input type="checkbox"/> Target size & shape notes								
<input type="checkbox"/> Point described	<input type="checkbox"/> Photo marked & numbered - also on back								
<input type="checkbox"/> Co-ordinates checked	<input type="checkbox"/> Notations below sketch completed								
<input type="checkbox"/> All points plotted with distances shown									

Notice of entry

The Surveyor is reminded that it is his responsibility to ensure that appropriate Notices of Entry have been served where private property must be entered.

3.6.6 Photogrammetry

The methodology used for the production of the GFM, the associated aerotriangulation adjustment and the extraction of data will be such that the information and accuracy requirements specified by the department are satisfied.

Table 3.6.6 – Guide for identification and coverage purposes

Guide for identification and coverage purposes			
Photo scale	Horiz. & vert. true position: 90% of points within	Interpolated vert. position from GFM 90% of points within	Spot heights grid spacings
1:3000	0.100 m	0.20 m	10 m
1:5000	0.120 m	0.24 m	15 m
1:7500	0.175 m	0.35 m	20 m
1:10000	0.250 m	0.50 m	25 m
1:15000	0.350 m	0.70 m	50 m

3.6.6.1 Specifications

Production of the ground and feature model data will be in accordance with the following specifications.

Terrain model

Terrain data is to be gathered using a combination of spot levels and breaklines. Sufficient points and breaklines are to be captured to allow the generation of a digital terrain model that meets the accuracy criteria stated in the contract brief.

Feature model

All features, both man-made and natural, within the nominated areas are to be located either as feature strings or feature points. Such features include, but are not limited to:

- roads
- line markings
- pavements
- fences
- drains
- power lines
- watercourses
- tracks
- kerb and channel

- services
- buildings
- structures, and
- entrances to properties.

Department of Transport and Main Roads regards the use of its standard feature coding as mandatory. A copy of the coding has been included in *Schedule 1 – Codes, Linestyles and Examples*. The coding has been specifically designed to provide a representation of the information required for design purposes.

It should be noted that some of the feature codes are direction-specific, e.g., watercourses must be digitised in the direction of flow. Fence lines and power lines must be digitised in order of occurrences so that the resultant plots will show the correct features joined.

In cases where the natural surface is obscured by thick vegetation, shadow or other obstacles as many breaklines and points as possible should be observed to give a true representation of the terrain. If the observer doubts that sufficient information can be obtained to give a true representation of the terrain in any area, these areas should be enclosed in a Boundary of Interest string.

Deliverables

All digital data shall be supplied in 12D archive format on the medium stated in the survey brief or agreed to with the Project Manager.

The consultant is to indicate any areas where the required accuracy has not been achieved by delivering boundary around this data using a Boundary of Interest string.

3.6.7 Field completion

For photogrammetric projects, field completion surveys may need to be undertaken to:

verify observations and interpretation made by the photogrammetrist

identify and record detail and/or information either not visible or not interpretable from the photography to connect by ground survey methods, all relevant features and information that cannot be located to the required accuracy by photogrammetry methods.

The types of information likely to be obtained during this stage include:

- land usage, vegetation, crops
- soil types, rock outcrops, slips
- springs, seepage
- buildings – heights and materials
- fence – no. and type of wire, condition or other
- overhead services – clearance at sag point
- connections to other surveys – cadastral and others
- surface position of ground level and underground services, including manholes, inspection boxes, marker posts, etc.
- invert levels of underground drainage structures

- features, levels and cross-sections in areas obscured by vegetation, and
- levels in watercourses, dams, etc., at:
 - water level, and
 - bed and/or cross-section.

3.6.7.1 Special requirements

Where the proposed road crosses existing roadways and/or is likely to join to an existing roadway and/or where it is known that existing services are likely to be relocated or joined to, the department may require that additional ground surveys be carried out to obtain complete details of these features. In such a case, special instructions will be issued.

3.7 Existing products

3.7.1 Aerial photography

The State of Queensland has been covered photographically at various scales, although not completely at any particular scale. Coverage is available in the following forms:

- Commonwealth photography
- State photography
- specific project photography, and
- specific departmental photography (e.g., Transport and Main Roads).

In general, the scales of photography range from 1:25000 to 1:80000. Project photography has been captured over limited areas for special requirements and varies in scale from 1:5000 upwards. Most of these forms of photography are suitable for investigation purposes and are obtainable from the Department of Resources (DoR) in Brisbane.

DoR in Brisbane maintains an index of all aerial photography flown for Queensland Government departments and authorities. Supply or loan of aerial photographs may be arranged by Geospatial Technologies.

3.7.2 Standard / topographic mapping

DoR is the official map producing agency for the state of Queensland.

A topographic map provides representation of the shape of the land, and natural and built features on the land. It allows the user to obtain measurements (within map scale limits) of distance, direction and quantity.

DoR's latest type of topographic map utilises a digital image of aerial photography corrected to scale as a background and is called a 'topographic image map'. In addition, the maps are enhanced to highlight natural characteristics and cultural features. This series of maps will become the standard map for Queensland.

The schedule below indicates the type, coverage and scale of available mapping over Queensland.

Topographic

Whole coverage of Qld	1:250000
Part coverage of Qld	1:100000
	1:50000
	1:25000

Topographic image

Part coverage of Qld	1:25000
----------------------	---------

Orthophoto maps

Part coverage of Qld	1:100000
	1:25000
	1:10000 (urban and developing areas)
	1:2500 (urban and developing areas)

3.7.3 Cadastral mapping

Cadastral map coverage of Queensland is available in the form of a database-derived computer image called 'Blinmap'. It is a 'specific' customer requirement product produced on demand.

4 Cadastral surveys

4.1 Introduction

4.1.1 Purpose

The purpose of this document is to provide a reference to the type of cadastral surveys, which may be carried out on behalf of the Queensland Department of Transport and Main Roads.

4.1.2 Scope

This part of the Surveying Standards sets out circumstances where cadastral surveys are carried out by, or on behalf of, the department. It also outlines the manner in which land is held or acquired by the department, as well as providing specific departmental requirements and guidelines for cadastral Surveyors not familiar with working within the department's environment.

This document does not replace the Cadastral Survey Requirements (CSR) in providing guidance to carry out a Cadastral Survey.

4.1.3 References

- *Land Title Practice Manual*
- *Transport and Main Roads Surveying Standards*
- *Cadastral Survey Requirements (CSR)*
- *The Registrar of Titles Directions for the Preparation of Plans*
- *Acquisition of Land Act 1967*
- *Regulation 2014*
- *Body Corporate and Community Management Act 1997 (BCCM)*
- *Regulation 2008*
- *(Accommodation Module) Regulation 2008*
- *(Commercial Module) Regulation 2008*
- *(Small Schemes Module) Regulation 2008*
- *(Specified Two-lot Schemes Module) Regulation 2011*
- *(Standard Module) Regulation 2008*
- *City of Brisbane Act 2010*
- *Regulation 2012*
- *Coastal Protection and Management Act 1995*
- *Regulation 2003*
- *Environmental Protection Act 1994*
- *Regulation 2008*
- *Housing Act 2003*
- *Regulation 2015*

- *Integrated Resort Development Act 1987*
- *Land Act 1994*
- *Regulation 2009*
- *Land Protection (Pest and Stock Route Management) Act 2002*
- *Regulation 2003*
- *Land Title Act 1994*
- *Regulation 2015*
- *Local Government Act 2009*
- *Regulation 2012*
- *Mixed Use Development Act 1993 (MUD)*
- *Native Title (Queensland) Act 1993*
- *Regulation 1996*
- *Property Law Act 1974*
- *Regulation 2013*
- *Registration of Plans (H.S.P. (Nominees) Pty. Limited) Enabling Act 1980*
- *Registration of Plans (Stage 2) (H.S.P. (Nominees) Pty. Limited) Enabling Act 1984*
- *River Improvement Trust Act 1940*
- *Regulation 2013*
- *South Bank Corporation Act 1989*
- *By-law 2014 (Modified Building Units and Group Titles)*
- *Regulation 2014*
- *Survey and Mapping Infrastructure Act 2003*
- *Regulation 2014*
- *(Survey Standards) Notice 2015*
- *(Survey Standards – requirements for Mining Tenures) Notice (No.1) 2011*
- *Surveyors Act 2003*
- *Surveyors Regulation 2014*
- *Sustainable Planning Act 2009*
- *Regulation 2009*
- *Transport Infrastructure Act 1994*
- *Regulation 1995*
- *(Busway) Regulation 2002*
- *(State-controlled Roads) Regulation 2006*

- *Water Act 2000*
- *Regulation 2002*

4.1.4 Definitions

Cadastral survey

Any process of determining, mapping or planning the boundaries of a parcel of land or waters required or authorised:

- a) leasing and occupation of State Lands or with mining, or affecting titles to land, or
- b) by the proprietor, lessee or mortgagee under any act affecting titles to land, or
- c) by the owner, proprietor, lessee, mortgagee or occupier of, or any person holding a registered interest in, any land for the re-establishment of, or identification of, or adjustment of any boundary of such land, or
- d) under any act to be made or certified by a cadastral surveyor (*Surveyors Act 1977*).

Department

The Queensland Department of Transport and Main Roads.

Engineering survey

A survey undertaken in conjunction with the investigation, planning, design and/or construction of an engineering project. In this document, it will usually refer to a survey undertaken in support of the department's road transport infrastructure.

Estate in fee simple

An estate of inheritance in land, which is absolute and without limitation. It implies full ownership in land, the tenure of which is freehold.

Cadastral Surveyor

A registered Surveyor whose registration is endorsed under the *Surveyors Act 2003* to the effect that the registered Surveyor may perform cadastral surveys.

Cadastral Survey Requirements

Sets out a range of information that surveyors may require in relation to the conduct of cadastral surveys.

Registered owner

The person recorded in the Automated Titling System (ATS) as the person entitled to the fee simple interest in a parcel of land.

Resumption plan

The R-Plan or sketch drawn by a District to indicate the intended area to be taken from a property, under the provisions of the *Acquisition of Land Act 1967*.

Survey brief

The survey instruction, given to the Cadastral Surveyor, which is issued by the Surveyor, in a District, whose responsibility it is to co-ordinate cadastral surveys.

Survey plan

Includes any survey plan, sketch for identification survey, map, aerial photograph or description made or obtained as part of any survey or surveys.

Surveyors Board of Queensland

This board is constituted under the *Surveyors Act 2003*.

4.2 Cadastral surveys for the Department of Transport and Main Roads

4.2.1 Acquisition of freehold land for roads

4.2.1.1 General

Generally, the majority of cadastral surveys for the department are initiated to acquire land for road and incidental purposes during the resumption process.

Responsibility for ensuring the cadastral survey has been carried out in the prescribed manner lies with the Cadastral Surveyor engaged for that purpose; however, the Cadastral Surveyor carrying out the work and the officer issuing the survey brief should be aware of specific requirements in relation to the above situations.

The acquisition of land for roads is dealt with under the provisions of the *Acquisition of Land Act 1967*, where 'land is taken for the purpose of transport, in particular, road purposes and vests in the Chief Executive, Department of Transport and Main Roads, as constructing authority for the State of Queensland'. This is done by Agreement in Writing under Section 15 or by Notice of Intention to Resume under Section 9.

The Region, which has the sole responsibility to approve the acquisition or disposal of land, and Property Services work together in determining a corridor of interest and acquiring the land needed to construct a new road alignment.

Initially the Region fixes the desired alignment, taking into consideration broad interest land use and community activities. This is followed by a public consultation process where affected registered owners, and the public in general, can ask questions and voice their concerns. After a final alignment is decided upon, all affected properties are checked for Native Title.

It is the role of Property Services to acquire all of the land needed and to negotiate compensation.

Even if only one affected registered owner objects to the acquisition of all, or part of, their land, the scheme is dealt with under Section 9 of the *Acquisition of Land Act 1967* as though no registered owner agreed. The process is generally as follows:

- A Notice of Intention to Resume is issued to the registered owner, showing the existing property description and the intended area to be taken, usually approximate only.
- The Notice of Intention to Resume is registered against the registered owner's title as an Administrative Advice.
- Time is allowed for objections.
- The objections are considered.
- The department makes application to the Minister to approve the scheme.
- If approved, application is made to the Governor in Council to assent to the scheme.

- If assented to, an initial Taking of Land Notice is published, in the Queensland Government Gazette, showing the existing property description and the intended area to be taken, usually approximate only.
Note: The department now has the right to enter the land and commence work.
- A copy of the Gazettal notice is served on the registered owner, accompanied by compensation claim forms.
- Compensation negotiations commence.
- A cadastral survey is requested, the result of which is a Survey Plan showing a new property description and the exact area to be taken.
- An amending Taking of Land Notice is published, in the Queensland Government Gazette, showing the new property description and the exact area to be taken.
- The Survey Plan is deposited with the Department of Resources for registration.
- Upon registration of the Survey Plan, a new title is issued to the registered owner for the balance land. The Administrative Advice is not registered against the new title.

If all affected registered owners agree to the acquisition of all, or part of, their land, the scheme is dealt with under Section 15 of the *Acquisition of Land Act 1967* and the department can proceed directly to making application to the Minister to approve the scheme. No Administrative Advice is registered against any registered owner's title.

If a hardship case can be proved, land can be taken under Section 15 of the *Acquisition of Land Act 1967* before a scheme is implemented. This is done to accommodate the mutual interests of the department, major stakeholders or the registered owner.

4.2.1.2 Freehold land acquired from registered owners other than government departments

Local governments are treated in the same manner as registered owners.

It is preferable that any freehold land acquired for possible future road purposes is held as an estate in fee simple. This gives the department greater control over the land in relation to the activities of public utility authorities. The department has limited control over land declared as 'road'.

The balance area of a single lot must remain as a single lot. Sometimes this requires the use of a 'vincula' or 'part lots'.

Resumed Access Restriction Lots need not be duplicated on the new alignment boundary. The *Integrated Planning Act 1997* (IPA) does not include provisions for conditions to be included in an approval of a plan. Therefore, the creation of Access Restriction Lots cannot be a condition of consent under IPA. Access is controlled by the department, under the provisions of Section 52(1) of the *Transport Infrastructure Act 1994*.

Where 'land is taken for the purpose of transport, in particular, road purposes and vests in the Chief Executive, Department of Transport and Main Roads, as constructing authority for the State of Queensland', it must be shown as a 'lot' not as 'new road'.

When the land is taken 'for an estate in fee simple', a title is issued to the department and the resumed area is shown on subsequent plans as a 'Lot'.

When the land is taken 'as road, no title is issued and the resumed area is shown on subsequent plans as 'road'.

The District draws a resumption plan to indicate the intended area to be taken from any affected property. This is the area shown in the 'Taking of Land Notice', published in the Queensland Government Gazette. If this intended area differs by more than 10% from the exact area shown on the Survey Plan, an amending Taking of Land Notice must be published and compensation will have to be re-negotiated.

Under the provisions of the *Acquisition of Land Act 1967*, the department acquires land unencumbered. Encumbrance easement boundaries, therefore, are not shown on the face of the Survey Plan over the acquired land. Though extinguished over the acquired land they are shown in the Encumbrance Easement Allocations on the back of the Survey Plan.

Survey Plans are signed by the department as 'Constructing Authority' not by the registered owner, therefore, the back of the Survey Plan must be left blank in this area and will be filled in by Property Services.

The statement 'NIR (dealing number) is satisfied by this plan' must be shown on the back of the Survey Plan if a Notice of Intention to Resume (NIR) is registered against the title.

Land acquired from different registered owners, excluding government departments, can be shown on the one Survey Plan.

If the new alignment boundary has been, or is being permanently fenced, the fencing should be adopted in lieu of the new alignment boundary shown on the Resumption Plan. If the fencing appears to be in error, the matter should be referred to the officer issuing the survey brief.

When the new alignment boundary is unfenced, and its position is defined in terms of offsets or co-ordinates related to an engineering survey, sufficient connections are to be made to the engineering survey to verify compliance with the design.

The CSR requires Survey Plans to show the intersection of new boundaries with registered easements. The department requires the intersection to be marked on the ground to assist the registered owner.

4.2.1.3 Freehold land acquired from government departments

Freehold land is acquired from government departments under the provisions of the *Land Title Act 1994*.

The department sends a copy of the Resumption Plan, showing the land required, to the government department and asks whether they are 'prepared to agree to the dedication of this land to road'. The resultant Survey Plan shows the acquired land as 'new road'. Sometimes the department acquires the land as an estate in fee simple. The resultant Survey Plan shows the acquired land as a 'lot'.

The Survey Plan is signed by the government department as the registered owner.

As such, a separate Survey Plan is required.

Local authority approval is not required.

Note: The Department of Housing has some land, which is 'State Land set apart under the *State Housing Act 1945* (repealed by the *Housing Act 2003*)'. As such, it does not appear in the ATS, but does appear in a database held by that department. The Department of Housing is attempting to convert this land to freehold land, to be held as an estate in fee simple.

4.2.1.4 Freehold land owned by the Department of Transport and Main Roads

The department when dealing with its own land does so under the provisions of the *Land Title Act 1994*.

When land is being reconfigured to set aside the department's immediate requirements, the resultant Survey Plan shows the land as 'new road'. If the requirements are not immediate, the resultant Survey Plan shows the land as a 'lot'.

The Survey Plan is signed by the department as the registered owner.

As such, a separate Survey Plan is required.

Under the provisions of Section 3.7.8 of the *Integrated Planning Act 1997*, local authority approval is not required.

Unfortunately, the department's land is usually surveyed later than the other land required for a new boundary alignment. This means duplication of effort and extra cost. If possible, efforts should be made by the Region to identify their requirements earlier.

4.2.2 Acquisition of state land for roads

State land required by the department is dealt with under the provisions of the *Land Act 1994*.

The land required is shown as 'Road to be Opened'.

The resultant Survey Plan is signed by a delegate for the Minister of Environmental Resource and Management.

The Land Management and Use Section of the Department of Environmental Resource and Management must be made aware of the department's requirements, otherwise the Survey Plan may not be acted upon.

State land cannot be dealt with on the same Survey Plan as freehold land.

As such, a separate Survey Plan is required.

4.2.3 Cadastral surveys requiring special attention

4.2.3.1 Reconfiguration of balance land

As part of the compensation process, it may be agreed to reconfigure the balance of the land.

The Survey Plan is signed by the registered owner.

As such, a separate Survey Plan is required.

Local authority approval is required.

4.2.3.2 Ambulatory boundaries

When defining ambulatory boundaries, the Cadastral Surveyor must consider the impact on all stakeholders who have an interest in the land. The implications are complex and can involve a conflict between the interests of the registered owner and State and Local Government. Other issues for consideration are those of Native Title and mineral extraction.

When ambulatory boundaries are involved, the Cadastral Surveyor must maintain close liaison with the officer issuing the survey brief throughout the commission. The department must be kept fully informed on any actions that the surveyor intends to implement which may be detrimental to the department's interests.

If the area, shown in the Taking of Land Notice, differs by more than 10% from the exact area shown on the Survey Plan, an amending Taking of Land Notice must be published and compensation will have to be re-negotiated.

To circumvent this situation arising, it is advisable to have the ambulatory boundary defined by the Cadastral Surveyor before the initial Taking of Land Notice is published.

4.2.3.3 Curtilage

Curtilage is described as an enclosed area immediately surrounding a house or dwelling, yard, courtyard or piece of ground, included within the fence surrounding a house or dwelling.

The acquisition of land regularly involves the severance of an existing improvement, structure or yard by the new boundary alignment.

The Taking of Land Notice describes the curtilage as 'land taken for a purpose incidental to the purpose of transport (road), in particular, removal of structures, and vests in the Chief Executive, Department of Transport and Main Roads, as constructing authority for the State of Queensland, for an estate in fee simple'.

The legal removal of the structure is achieved through temporary transfer of ownership, to the department, of the land that borders the proposed new boundary alignment and encloses that part of the severed structure within the registered owners 'balance area'.

The curtilage may or may not be surveyed.

If surveyed, the Survey Plan shows the curtilage as a 'Lot'.

If the curtilage is not to be surveyed, and the structure has not been removed at the time of survey, the Cadastral Surveyor treats the situation as an encroachment.

Following removal and Site clean-up, ownership is transferred back to the registered owner, for a nominal amount, through a Survey Plan compiled to establish a single 'Lot'.

4.2.3.4 Lease

A Cadastral Survey can be required to define:

- Sections of state-owned / controlled land to ensure continuity of lease area, for specific purposes by non-government agencies. The department leases sections of road corridor to Queensland Motorway Limited.
- Single use transport corridors. Queensland Transport is currently (2003) defining 'Queensland Rail' and 'South East Transit Busway' corridors.
- Shared responsibility areas. The department is currently (2003) negotiating with Queensland Rail to determine shared responsibility at all intersections of the two infrastructures.

Generally, the two types of tenure to be included in a lease will be 'freehold' and/or 'reserve for road'. Freehold land remains freehold and state land (road, reserves, etc.) is converted to 'reserve for road'.

In 2003, the DoR was exploring the feasibility of converting the various types of state Land to a single type, which can be leased to the principal controller, the department, and then sub-leased to the secondary stakeholder, Transurban Queensland (TQ).

Consideration must be given to the need for a cadastral survey to define easements for public utility authorities, particularly for land that was previously 'road', where no easement may have existed, or where an easement may have been extinguished.

'Easement in gross' is an option available to reduce the extent of survey to separate individual utilities.

4.2.3.5 Native Title

Native Title needs to be determined where existing road infrastructure intersects Unallocated State Land (USL). Watercourse crossings are generally covered with the adaptation of existing bridge plans. New bridge and bridge widening schemes also use this economic approach.

Native Title over USL can also involve air space.

The Cadastral Surveyor must be familiar with the relevant Native Title legislation and departmental policies.

4.2.3.6 Revocation

The action of 'revocation' is such that the acquisition of land, in either full or in part, never happened.

It is dealt with under the provisions of Section 17 of the *Acquisition of Land Act 1967*, but only if compensation has not been paid. If compensation has been paid, the matter is dealt with as a 'road closure' under the provisions of the *Land Act 1994*.

The department will seek 'revocation' only when it is in the best interest of the registered owner and the department.

A Survey Plan is required to define the area to be revoked.

The following statement is shown on the face of the Survey Plan:

"Area revoked and added to Lot xx on SPnnnnnn (a-b-c-.....-a) m²/ ha"

The wording for the title block depends on whether the acquired area was taken as 'road' or a 'lot' and whether the revocation is whole or partial.

If the acquired land is taken as 'road' and revocation is partial, then the title block is:

"Plan of Lot xx cancelling Lot xx on SPnnnnnn and Part of Lot yy on SPnnnnnn".

If the acquired land is taken as 'road' and revocation is whole, then the title block is:

"Plan of Lots xx and yy cancelling Lots xx and yy on SPnnnnnn".

If the acquired land is taken as a 'lot', and revocation is partial then the title block is:

"Plan of Lots xx and yy cancelling Lots xx and yy on SPnnnnnn".

4.2.3.7 Resumption of possession of a reservation in title

The Resumption of Possession of a Reservation in Title, whether whole or partial, is dealt with under the provisions of the *Land Act 1994*.

The land required is shown as **Lot xx** and the following statement is shown on the face of the Survey Plan:

"The area m²/ ha reserved for road purposes in Lot yy on ABnnnnnn may be allocated to Lot xx as shown hereon.

(Date) for General Manager, Land Management and Use"

The balance of the 'Reservation in Title', if any, is allocated to the balance land.

The Certificate of Title to the balance land is surrendered and a new Deed of Grant is issued.

Lot xx is shown as 'road' on subsequent Survey Plans.

Because the land becomes 'road', the department has limited control over the land. If the department requires greater control over the land, they can make application to the Department of Environmental Resource and Management to set aside a 'Reserve for Road Purposes' with the department as trustee.

In this situation, **Lot xx** is shown as '**xx**' on subsequent plans.

No compensation is paid for the land acquired, only for any improvements.

If the land required is greater than the area of the 'Reservation in Title', the balance land is taken under the provisions of the *Acquisition on Land Act 1967*.

As such, a second Survey Plan is required.

Compensation is paid for this balance land.

4.2.3.8 Volumetric

Survey Plans (volumetric) for bridges are required when they cross either privately owned Freehold Land or local government roads.

Resumption plans will give the intended XYZ co-ordinates required, but the adopted XYZ co-ordinates will be determined by the 'As Constructed' bridge.

Generally, the volumetric planes are set at 50 mm to 100 mm off the concrete faces of the abutments, piers and underside of the bridge.

The planes parallel to the underside of the bridge extend 2 metres beyond the parapets, and then vertically to 20 metres above the pavement.

This provides legal access to maintenance cages and maximum height light standards.

The 20 metre requirement can be varied to ensure the intended volume shown in the Taking of Land Notice does not differ by more than 10% from the exact volume shown on the Survey Plan.

'As Constructed' drawing dimensions are used and referenced on the Survey Plan for inaccessible features, such as spread footings and piles.

The isometric drafting of the volumetric lot is simplified as much as allowable to maintain all concrete within the envelop while meeting intent.

Survey Plans (volumetric) are required for tunnels when they are under either privately owned Freehold Land or local government roads.

For Freehold Land, the result can be either a volumetric lot or 'new road'.

For local government roads, the result can be either, 'road to be opened' or a 'reserve for road'.

Survey Plans (volumetric) are also required for bikeways or footpaths under, or to, road bridges or adjacent private enterprise ventures.

These situations entail specific legal responsibilities for the department, local governments and the private enterprise venture.

'Standard' lots and 'Volumetric' lots cannot be dealt with on the same Survey Plan.

4.3 Survey brief

4.3.1 General

The officer issuing the survey brief should list specific requirements to ensure the cadastral survey meets the department's requirements. Reference should also be made to the Cadastral Survey Requirements for DoR's current requirements regarding cadastral surveys.

4.3.2 Survey commencement

The officer issuing the survey brief and offer should ensure there is:

- agreement to a mutually acceptable starting date
- agreement to the co-ordination of field activities to protect survey marks
- the inclusion of pre-examination fees for the resultant Survey Plans, and
- the provision of:
 - a current Resumption Plan. The Resumption Plan needs to be current, satisfy the department's requirements and to show the correct area of land to be acquired
 - a schedule of tenure
 - a list of registered owners' names and addresses
 - a copy of the Queensland Government Gazette showing the Taking of Land Notices
 - copies of current Title Searches
 - copies of all relevant Survey Plans, and Permanent Mark sketches and their associated reports, and
 - copies of all relevant departmental working plans and/or field notes.

4.3.3 Survey completion

Upon completion of the survey, the officer issuing the survey brief should ensure that:

- all original Survey Plans have been forwarded to the officer issuing the survey brief
- all original Survey Plans have been pre-examined and endorsed by an accredited agency, and
- all documentation obtained, by the Cadastral Surveyor, as part of the Title Search have been forwarded.

5 GNSS survey control network

5.1 Introduction

The survey control network defines the position of a project as evidenced by the coordinates of the survey control network marks. There are a variety of measurement and processing techniques available to define the survey control network. Static GNSS measurement techniques and least squares network adjustment processing techniques are the most common and are highly recommended. The Surveyor must select the equipment and techniques which best suit the requirements of the project.

5.1.1 Purpose

The purpose of this section is to provide users of GNSS with the department's requirements for undertaking survey control network coordination.

5.1.2 Scope

The scope of these Standards is to outline the departments' requirements in regards to equipment, technique, quality requirements, network design and deliverables. The Standards also directs users to the relevant national guidelines applicable in performing the control surveys for, or on behalf of, the department.

5.1.3 References

The following publications, or their successors, are to be used in conjunction with this document as referenced in the text:

1. *Standards and Practices for Control Surveys (SP1)* - Inter-Governmental Advisory Committee on Surveying and Mapping (ICSM) Publication. The document is available in .pdf format from the ICSM website <http://www.icsm.gov.au>
2. *GDA Technical Manual* - Inter-Governmental Advisory Committee on Surveying and Mapping (ICSM) publication. The document is available in .pdf format from the ICSM website <http://www.icsm.gov.au>

5.1.4 Definitions

The following definitions are to be used in the context of this document.

Baseline

A baseline is the vector between two survey marks upon which survey quality GNSS receivers have observed common satellites simultaneously. The geodetic parameters are estimated at one station relative to another.

Epoch

The sampling period cycle, e.g., 15 second epoch is sampling at every 15 seconds.

Multipath

This is when the carrier wave(s) are reflected from other surfaces before being recorded at the receiver. This affects the carrier phase measurement as the carrier wave travels a longer path. Multipath errors can be alleviated by allowing longer reception times, which allow for a change in satellite geometry.

5.1.5 Acronyms

The following acronyms have been used throughout this section:

AHD71	<i>Australian Height Datum 1971</i>
AUSPOS	<i>Geoscience Australia Online GNSS Processing System</i>
DoR	<i>Department of Resources</i>
GA	<i>Geoscience Australia</i>
GDA2020	<i>Geocentric Datum of Australia 2020</i>
GNSS	<i>Global Navigation Satellite System</i>
GPS	<i>Global Positioning System</i>
ICSM	<i>Intergovernmental Advisory Committee on Surveying and Mapping</i>
MGA	<i>Map Grid of Australia</i>
PCP	<i>Photogrammetric Control Point</i>
PSM	<i>Permanent Survey Mark (also known as PM: Permanent Mark)</i>
SCDB	<i>Survey Control Database</i>
SP1	<i>ICSM Standards and Practices for Control Surveys Special Publication 1 v2.1</i>
WGS84	<i>World Geodetic System 1984</i>

5.2 General requirements

The survey control network is the skeleton that all other project survey information is referenced to. Survey control network marks are the primary survey control for a project.

ICSM's Standard for the *Australian Survey Control Network, ICSM Special Publication 1 (SP1) v2.2* set the standard for survey control networks. Control surveys undertaken for the department shall be based on SP1 guidelines. Further information can be found at:

Standard for the *Australian Survey Control Network Special Publication 1 (SP1)* | Intergovernmental Committee on Surveying and Mapping (<https://icsm.gov.au/>).

Control Surveys for the department are also governed by the *Survey and Mapping Infrastructure Act 2003* and *Survey and Mapping Infrastructure Regulation 2014*.

5.3 Connection to datum

The Survey control network shall be coordinated relative to the departments specified datum's (refer Section 5 of *Part 1 – General Information*). Datum in Queensland is referenced by PSM's in DoR's Survey Datum Control database. This datum control survey network is maintained as the Survey Control Database (SCDB) and readily available in the Queensland Globe. To rigorously propagate datum to the project survey control, direct measurements to the datum control survey mark network are required. A minimum of three horizontal datum control points shall be connected to in every survey control network. If the GNSS network is to be used to define heights on the project, a minimum of three vertical datum control points shall be connected to.

5.4 Datum control

Datum Control marks of sufficient quality within the Survey Control Database (SCDB) of Permanent Survey Marks (PSM) administered by the DoR shall be the datum (origin) of the project survey control.

5.4.1 Horizontal

Registered PSM's used as Datum Control to derive horizontal coordinates of the survey control network shall have a Horizontal Positional Uncertainty of < 0.020 m. A hierarchical system shall be used when selecting Datum Control PSM's based on GDA2020 horizontal uncertainty, suitability and stability of the mark. Distance from the project site is also an important consideration. In descending order of desirability:

- i. Tier 1 and 2 Continuously Operating Reference Stations (CORS) with Regulation 13 certificate
- ii. Tier 3 Continuously Operating Reference Stations (CORS)
- iii. QLD ANJ adjustment PSM's with PU < 0.020 m
- iv. PSM's with PU < 0.020 m

5.4.2 Vertical

A hierarchical system shall be used when selecting PSM's to derive the height of project survey control. The system is based on GDA2020 ellipsoidal vertical positional uncertainty, AHD quality, and stability of the mark. Distance from the project site is also an important consideration.

- i. QLD ANJ adjustment PSM's with Ellipsoidal PU < 0.050 m & AHD 3rd Order Class C quality
- ii. AHD 3rd Order Class C quality PSM's
- iii. QLD ANJ adjustment PSM's with Ellipsoidal PU < 0.050 m & AHD 4th Order (minimum Class D) quality
- iv. AHD 4th Order (minimum Class D) quality PSM's

5.5 Quantifying survey quality

The ICSM *Standard for the Australian Survey Control Network - SP1 v2.2* (or its successor) is to be used as the basis as to the minimum requirements for determining position and associated uncertainty for survey control network. SP1 v2.2 completes the transition from CLASS and ORDER to Uncertainty as the basis for evaluating and expressing the quality of measurements and positions.

The purpose of the SP1 standard is *"to specify the minimum requirements for the determination of one, two, or three dimensional position and associated uncertainty of Australia's survey control marks"*.

5.5.1 Uncertainty

SP1 states:

“The quality of a control survey shall be quantified in terms of uncertainty. When quantifying survey quality, the following uncertainty categories shall apply:

Survey Uncertainty (SU) *is the uncertainty of the horizontal and/or vertical coordinates of a survey control mark relative to the survey in which it was observed and is free from the influence of any imprecision or inaccuracy in the underlying datum realisation. Therefore, SU reflects only the uncertainty resulting from survey measurements, measurement precisions, network geometry and the choice of constraint. A minimally constrained least squares adjustment is the preferred and most rigorous way to estimate and test SU. SU is expressed in SI units at the 95% confidence level.*

Positional Uncertainty (PU) *is the uncertainty of the horizontal and/or vertical coordinates of a survey control mark with respect to the defined datum and represents the combined uncertainty of the existing datum realisation and the new control survey. That is, PU includes SU as well as the uncertainty of the existing survey control marks to which a new control survey is connected. A fully constrained least squares adjustment is the preferred and most rigorous way to estimate and test PU. PU is expressed in SI units at the 95% confidence level.*

Relative Uncertainty (RU) *is the uncertainty between the horizontal and/or vertical coordinates of any two survey control marks. Such marks may be connected by measurement directly or indirectly. The preferred and most rigorous means for deriving RU between pairs of marks is by propagating the respective variances and co-variances obtained from a minimally or fully constrained least squares adjustment (i.e. from SU or PU). RU can be expressed in SI units at the 95% confidence level, or in a proportional form such as a ratio of uncertainty per unit length or survey misclosure.”*

5.5.2 Evaluating and expressing uncertainty

SU shall be estimated and tested using a minimally constrained least squares adjustment.

PU shall be estimated and tested by way of a fully constrained least squares adjustment.

SU and PU of Survey Control shall be expressed in terms of a horizontal circular confidence region at the 95% confidence interval.

5.5.3 Survey control network uncertainty

A projects survey control network marks shall meet or exceed a Horizontal Survey Uncertainty (SU) of < 0.015 m and a Positional Uncertainty (PU) of < 0.030 m.

5.6 Field acquisition

Quick Static and Classic Static GNSS networks are the most accurate and reliable methods for coordinate definition and subsequent evaluation of uncertainty of project survey control.

The influence of internal and external effects should be minimised by good Site selection and network planning. Typical factors affecting GNSS measurements are (vide SP1):

- GNSS system effects such as the ephemeris error and satellite availability and geometry at each survey site
- atmospheric effects due to the ionosphere and troposphere

- site dependant effects such as obstructions, multipath and interference from non-GNSS radio sources, and
- instrumental effects, unmodelled antenna centre phase offsets.

Well accepted methods for minimising errors due to these effects are redundancy in the observations, absence of signal obstructions and longer observation times.

Effects external to the GNSS measurements should be eliminated by incorporating procedures for minimising blunders such as checking mark identifiers, centring and orientation of the antenna, and the measurement of antenna heights.

5.6.1 Equipment and Observation Technique

Static GNSS surveys to coordinate project survey control marks will adhere to equipment requirements and observation techniques as detailed in Section 3.2.1 of *SP1 Guideline for Control Surveys by GNSS*. Baselines less than 10 km shall follow requirements for Quick Static. Classic Static requirements will be followed for baselines over 10 km.

Surveyors should be aware that achieving a high quality ellipsoidal height requires significantly more attention than the horizontal component does. For height, GNSS observation time is particularly important. Longer observation time minimise the effects of the atmosphere, especially the troposphere, as well as satellite geometry and antenna particulars.

5.6.2 Network design

The design of the network may affect the results that are obtained from the survey. It is recommended that the following aspects be followed for good network design:

- acquire control of sufficient quality close to the project area
- use good network geometry
- build network redundancy
- require two independent occupations per mark
- use stations with low multipath, and
- do not let logistical constraints degrade the network design.

5.6.3 Observation records

Field observation logging sheets shall be completed for each receiver session. The receiver type, serial number, station name, antenna height (including the actual measuring point on the antennae) and start and stop times shall be noted. The file number of each receiver session shall be added in processing phase.

Photos are an easy way of providing quality assurance and confidence in the setup. Photos shall be taken of every receiver setup showing, and in this order:

- verification of the physical mark showing its identifier
- the receiver ID
- the height measurement at the start of the session
- the level bubble

- the optical plummet crosshairs on the mark (through the optical plummet)
- any obstructions that may affect the processing, and
- the height measurement at the end of the session.

5.7 Processing and adjustment

After all GNSS baselines have been measured, the data should be downloaded into the GNSS manufacturer's proprietary software and the baselines processed. An analysis of loop closure misclose should be conducted. Using least squares network adjustment software, a minimally constrained least squares adjustment shall be performed, followed by a constrained adjustment to verify that the survey meets the required standards. Adjustments shall be run and reported at 95% confidence level. Survey uncertainty shall be determined on the basis of the minimally constrained least squares adjustment. Positional uncertainty shall be determined on the basis of a constrained least squares network adjustment. Uncertainties shall meet or exceed the values listed in Section 5.5.3 of this document.

5.8 Deliverables

The following files, reports and forms listed below shall form part of the corporate record of survey and included where applicable in the fieldbook:

- least squares network adjustment project
- raw GNSS receiver files
- table of adjusted co-ordinates
- baseline loop closure details from processing software
- report on the minimally constrained adjustment (generated from software)
- report on the constrained adjustment (generated from software)
- GNSS occupation log sheets
- Uncertainty calculation records
- PSM Form 6's used as datum control
- New and updated PSM Form 6's
- PSM Maintenance forms for all PSM's searched for (excluding new and updated as above)
- Occupation photos of each receiver setup, and
- RINEX files (v2.11) for all valid observations corrected for mark name, antenna height and type.

The Project Manager shall forward to DoR: all new PSM forms; PSM maintenance forms; GNSS occupation log sheets; occupation photos; and RINEX files

6 Construction Surveys

6.1 Introduction

Construction surveying enables the construction of designed infrastructure. It involves the processes of setting out design features, conformance checks and As Constructed surveys.

6.1.1 Purpose

This chapter outlines the department's requirements in performing construction surveys for:

- Road infrastructure
- Bridges, and
- Underground Assets

6.1.2 Scope

This chapter provides standards for construction surveys undertaken by, or on the behalf of, the department. Requirements for carrying out the various tasks associated with construction surveys including survey control, conformance checks through quality control, As Constructed surveys and deliverables are addressed.

6.2 Surveyor requirements

A Surveyor must meet the competency requirements for the relevant categories of road and bridge construction as specified in Section 2.4.3 of *Part 1 – General Information*.

6.3 Equipment

All survey equipment used on construction projects must meet the requirements detailed in Section 2.4.4 of *Part 1 – General Information*. Calibration certificates must be retained by the Surveyor, form part of the onsite survey records, and be produced on request to the Project Manager or his authorised representative.

6.3.1 EDM and ancillary equipment

The collimation of all survey instruments used for construction setout must be frequently checked and must always be within the manufacturers stated precisions. Records of each collimation check (including date) should be retained by the Surveyor and be produced on request to the Project Manager or his authorised representative.

Survey Total Stations used for Bridge setout surveys must meet additional requirements detailed in Section 6.6.4.1 of this document.

6.3.2 GNSS equipment

GNSS equipment used for construction set out must have the following characteristics:

- a) Survey quality GNSS equipment that measure precise code and carrier phase (dual frequency) measurements.
- b) Applicable radio communication licence authorisation from the Australian Communications & Media Authority (ACMA).

GNSS survey equipment and technique must be frequently validated by occupying and recording measurements on established survey control marks and comparing field recorded coordinates with accepted project survey control coordinates. Validation check records must be produced on request to the Project Manager or his authorised representative.

Real Time GNSS (RTK) procedures must not be used for height determination where construction accuracy of less than 30 mm is specified.

6.4 Construction project survey control

Construction Project Survey Control shall use as datum, where available, the projects underlying survey control network used to create the construction design i.e. the pre-design survey. Survey accuracy control requirements for construction purposes are specified in MRTS56 *Construction Surveying*.

6.4.1 Survey mark protection

Survey mark protection requirements are specified in MRTS56 *Construction Surveying*.

6.4.2 Survey control register

An up to date Survey Control Register that includes all survey control marks used on the construction project must be maintained during the project and delivered upon completion of the project Works. Information contained within the Survey Control Register must include:

- A unique number / identifier for each survey control mark.
- An Easting, Northing and Height for each survey control mark.
- A description of the physical nature of each survey control mark (e.g. star picket, screw in concrete, etc).
- Destroyed survey control marks.
- Survey adjustment report/s (e.g. least squares adjustment report when adjusting new marks to the survey control network marks).
- When using a non-standard datum, translation parameters to accurately transform project coordinates to the standard datum (GDA2020 / MGA zone 5*, AHD).

6.5 Road Infrastructure Construction Survey

Refer to MRTS56 *Construction Surveying*.

6.5.1 6.5.1 Volume survey

Volume Surveys shall be undertaken a Surveyor who meets the requirements of R1 or above in Section 2.4.3 of the *Part 1 – General Information*.

Surveys undertaken to calculate a volume shall be guided principally by the requirements for a Ground and Feature Model survey as detailed in Section 1 of this document. The department's standard Survey Feature Codes as specified in the current *Schedule 1 – Codes, Linestyles and Examples* shall be used to code the strings and points used to define the surface. The survey model must include a three dimensional boundary string that defines the limit of the quantity being measured.

Line quality check strings as prescribed in Section 1.3.4.1 of this document are to be run across all base and volume surfaces (including existing pre-design surveys used as a base) and compared to the corresponding surface triangulation to verify the quality of the surveyed surface.

6.5.1.1 Base surface

The base survey surface should be agreed to by the Site Engineer. All base surfaces must be larger than the feature that the volume is to be determined for. A buffer of at least 10 m is highly recommended.

All base surface survey points shall be surveyed to the accuracy requirements stated in Section 1.3.1.4 of this document for the particular type of feature point being located. When locating pavement, it must be located to the accuracies stated for pavement. Similarly, when locating off pavement ground terrain, accuracy shall meet requirements for “Other”.

Where an existing pre-design survey is used as the base surface, care must be exercised to ensure the survey datum is compatible.

6.5.1.2 Constructed feature volume

Where a volume (cut or fill) is required of a constructed feature (e.g. sub-grade), the field method chosen should be able to provide an accuracy of half the tolerance required by the contract documentation (e.g. subgrade has a construction tolerance of +/- 25 mm, the field survey method chosen for the volume GFM should be capable of achieving +/- 12.5 mm).

6.5.1.3 Stockpile volume

Surveys to calculate a stockpile volume shall be undertaken by methods and equipment that enable the accuracy requirements stated in *Section 1.3.1.4 Accuracies* for ‘Other’ feature points to be met.

6.5.1.4 Calculation

A number of suitable methods of accurate volume calculation are available including the ‘TIN to TIN’ method. All calculated volumes will be quality checked by a different method. Some calculation methods for volumes are more accurate and rigorous than others and should be discussed with and approved by the Site Engineer.

Line quality check strings are to be compared for compliance to the volume surface as defined by the TIN produced from the volume survey GFM. The levels at the plan position of each discrete point on these quality strings are to be compared to the TIN levels at that plan position and differences reported.

Nominal compaction or expansion (bulking) factors to be applied shall be at the direction of and determined by the Site Engineer.

6.5.1.5 Reporting

The volume report shall detail the following information:

- Site and feature identification e.g. stockpile name, Chainages, surface name.
- Datum and Survey Control information.
- Where TIN's have been used, the TIN names shall be listed.
- Where a compaction or expansion (bulking) factor has been used, the following shall be shown:
 - The base 1:1 calculated volume
 - The compaction or expansion (bulking) factor used

- The calculated volume with the compaction or expansion (bulking) factor applied, and
- Signed and dated by a Surveyor who meets stated requirements.

6.5.1.6 Deliverables

Deliverables shall include:

- Volume report
- Quality check strings report
- A computer file of the base surface strings in a suitable format for input into the department's standard software (12d archive, AutoCad dxf or dwg) that will produce an accurate surface model of the base surface, and
- A computer file of the volume survey GFM's surface strings including line quality check strings in a suitable format for input into the department's standard software (12d archive, AutoCad dxf or dwg) that will produce an accurate surface model of the surveyed surface.

6.6 Bridge Construction Survey

Refer to MRTS56 *Construction Surveying*.

In addition to MRTS56 *Construction Surveying*, this chapter outlines the department's requirements for bridge construction surveys.

6.6.1 Introduction

The section details the survey standards for meeting the bridge survey control requirements and setting out techniques for bridge construction surveys.

Excerpts for this section are adopted from Clause 5.5.1 of *Roads and Maritime Services (RMS) QA Specification G71 Construction Surveys, Edition 1/Revision 4 July 2014* and a paper presented by Jim Ollis at the FIG Congress 2011 titled "A National Survey Standard for Road and Bridge Construction in Australia and New Zealand".

6.6.2 Bridge design drawings

Bridges are required to be constructed within allowable tolerances to the designed positions and measurements as detailed on the design drawings. The bridge design drawings are the legal documents and therefore the one true source of design information. Electronic data like an Electronic Project Model of the design, whilst very useful, do not take precedence over the construction plans. The creation and use of an Electronic Project Model is greatly encouraged.

Bridge design drawings and Electronic Project Model must be checked for mistakes and consistency. If mistakes or inconsistencies are found the Project Manager must be contacted immediately.

6.6.3 Bridge survey control

Bridge Survey Control is distinct from project survey control in that it uses ground distances in preference to GDA2020 / MGA zone 5* grid distances adopted for project control or other Map Projections based on the *Geocentric Datum of Australia 2020* (GDA2020). The grid combined scale factor (combined scale factor is the combination of map projection scale factor and height scale factor) can have a significant impact on construction tolerances. Large components such as girders that are constructed off Site will generally be constructed using the plan dimensions, that is, ground distances. It is possible that the difference between grid distances and ground distances could cause significant nonconformance resulting in significant rework and cost. For very long bridges, it could cause significant dimensional difference between the constructed overall length and the designed overall length.

For consistency, a scale factor of one shall be applied to all bridge survey controls, even though some bridges are constructed insitu and other Sites may have a grid combined scale factor approximating one, thereby causing negligible effect.

Bridge Survey Control must adopt the coordinates of one of the control marks from the main Project Survey Control (based on GDA2020 / MGA zone 5* or other Map Projections based on GDA2020). The coordinates of this adopted hold mark must have the first digit from the Easting and Northing coordinate deleted. This is done to avoid confusion between the Bridge Survey Control and the overall Project Survey Control coordinates.

Bridge Survey Control must be on the same azimuth as the main Project Survey Control.

Coordinates for all the Bridge Survey Control must be calculated using ground (plane) distances. The Bridge Survey Control must include at least three existing Project Survey Control marks for each bridge.

6.6.4 Bridge survey control network

A braced network consisting of at least four Bridge Control Stations (BCSs) surrounding the bridge Site should be used. The BCSs need to be substantial marks placed in positions not likely to be disturbed during construction but visible from the construction Site. They need to be inter-visible between each other. Refer Section 6.6.11.1 of this document for different network scenarios.

BCS's need to meet the same installation criteria requirements as PSMs as prescribed in Section 6.4.1 of *Part 1 – General Information*. There is no requirement for a concrete collar or registration number.

After completion of pile driving Works, the bridge survey control network shall be checked for movement. If any mark has moved, corrective action must be taken to redefine its position.

6.6.4.1 Measurements

Measurements need to be conducted using a Total Station with angular precision capability of 3" of arc and distance precision of 2 mm + 2 ppm. A minimum of six sets of angular and distance measurements from each station is required. At least two original Project Survey Control marks included in a least squares adjustment. The use of mini or 360° prisms on Project or Bridge Control Stations is unacceptable.

6.6.4.2 Adjustments

A statistical analysis using a minimally constrained 'least squares' adjustment method, holding one fixed station and azimuth between two stations, should be applied for obtaining final coordinate results. The Survey Uncertainty (SU) of each Bridge Control Station should be no greater than 2 mm at 95% confidence level.

6.6.4.3 Resected secondary bridge control marks

There may be instances where direct line of site from the Bridge Control Stations (BCS) to some bridge components may be obstructed. In these instances, secondary Bridge Control marks may be installed.

These are generally less robust marks (e.g. nails in concrete) and may establish horizontal coordinates by resection methodology under the following conditions:

- Observations to a minimum of three Bridge Control Stations (BCS) on both faces should be measured.
- Angular geometry needs to be sound. Small measurement errors increase the resultant error ellipse rapidly on very narrow angle geometry. Angles less than 10° should not be used.
- Tripod mounted traverse prisms should be used on all BCS.
- Once resected coordinates are calculated, use these to set out BCS's and compare resultant differences. Accept if coordinates are within +/- 3 mm.
- Check to a fourth BCS or a previously set out point from a different set out station. Accept result if coordinate is within +/- 3 mm.
- Other resected marks shall not be used as part of a resection.

6.6.5 Heights

If a Permanent Survey Mark or Bench Mark adjacent to the bridge locations was surveyed in the GFM survey it should be used as height reference datum for the bridge construction, subject to verification by a two way level run to another PSM or BM within the Project Survey Control.

A Bridge Control Station (BCS) can be used as a Temporary Bench Mark (TBM). It is preferable that this BCS is placed in a suitable stable location adjacent to the Site to enable construction personnel to use for height reference. Height values for the TBM are to be determined from the average of two independent level runs between two existing Permanent Survey Marks (PMs) or BMs with verification to other Project Survey Control is required.

Levelling accuracy to define or confirm the height of the bridge height reference datum mark must meet an allowable misclose of $12 \text{ mm} * \sqrt{\text{km}}$.

An independent two way level run is then required on all remaining BCSs holding the height value previously determined / adopted as the height reference datum. The allowable misclose for this level run is $6 \text{ mm} * \sqrt{\text{km}}$.

All Bridge Control Stations, PSMs, BMs and Temporary Bench Marks in the immediate vicinity of the bridge shall be re-levelled from the height reference datum marks after completion of pile driving.

6.6.6 Bridge coordinate system

As with the adopted coordinate from the Project Survey Control, all supplied coordinates of bridge features for example, abutments and piers, must also have the first digit from the Easting and Northing coordinates deleted to be in the same terms as the Bridge Survey Control.

6.6.7 Survey setout tolerances

For all bridge setting out requirements, refer to MRTS56 *Construction Surveying*.

6.6.8 Set out techniques

6.6.8.1 Radiation

The backsight distance must be at least twice the distance of the longest radiation sight distance. The maximum radiation sight distance permitted is 70 m. Excerpts for this section are adopted from Clause A2.2.1 (f) and (g) of *Roads and Maritime Services (RMS) QA Specification Guide NG71 Guide to QA Specification G71 Construction Surveys, Edition 2/Revision 0 December 2020*.

6.6.8.2 Bridge control line

The Bridge Control Line is usually required to be set out as a reference control line for the bridge construction personnel. For straight line geometry, pier centreline locations (refer Figure 6.6.8.2) and two offset marks are placed on either side of the proposed abutments as shown in Figure 6.6.8.3.

The Bridge Control Line is required to be set out from a Bridge Control Station (BCS) and checked from a second BCS. Independent linear measurements between the Bridge Control Line marks is also required using a calibrated tape or chain. Check linear measurements should agree to within +/- 3 mm of design values.

Figure 6.6.8.2 – Bridge control line

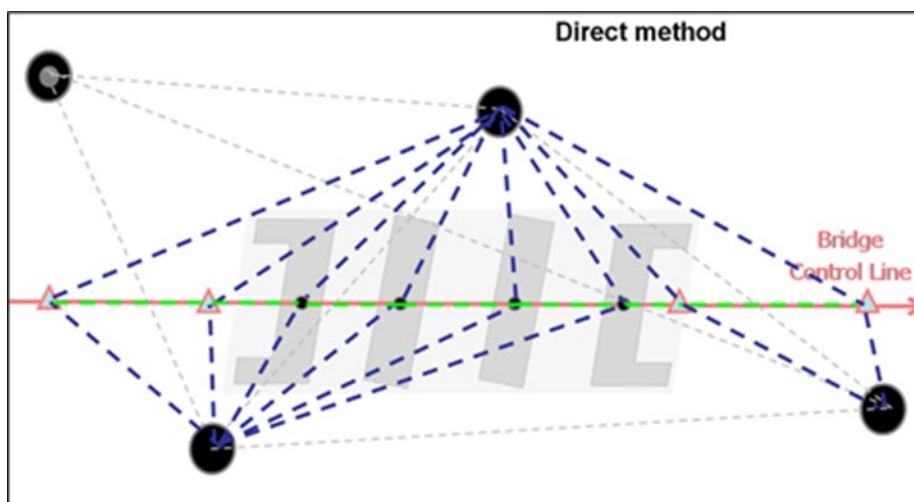

6.6.8.3 Abutment and Pier Control Lines

The Abutment and Pier Control lines are often required for construction personnel to install and check pile locations and pier false work. Setting out of the Abutment and Pier Control Line marks is required from a Bridge Control Station (BCS) and checked from a second BCS. Independent linear measurements of Abutment and Pier Control Line marks is also required using a calibrated tape or chain. Check linear measurements should agree to within +/- 3 mm of calculated values (see Figure 6.6.8.3).

Figure 6.6.8.3 – Abutment and pier control lines

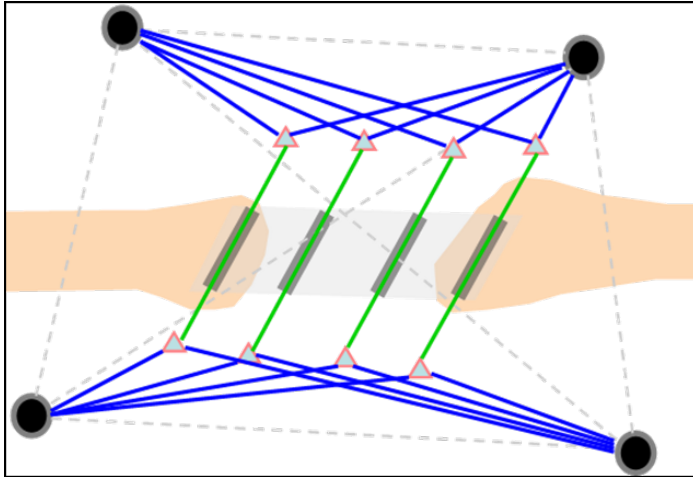

6.6.8.4 Setting out from the Bridge Control Stations (BCSs)

For complex bridges, Surveyors are often required for setting out of all or most of the bridge components. Setting out and final checks of Abutments and Headstocks for the falsework and formwork is required from at least two independent Bridge Control Stations (BCSs). Independent checks of the external dimensions is also required (see Figure 6.6.8.4(a)). Check external dimensions should be within at least half of the construction tolerances. The check set out measurements should agree to within +/- 3 mm of each other.

Figure 6.6.8.4(a) – Multi station setout and checks

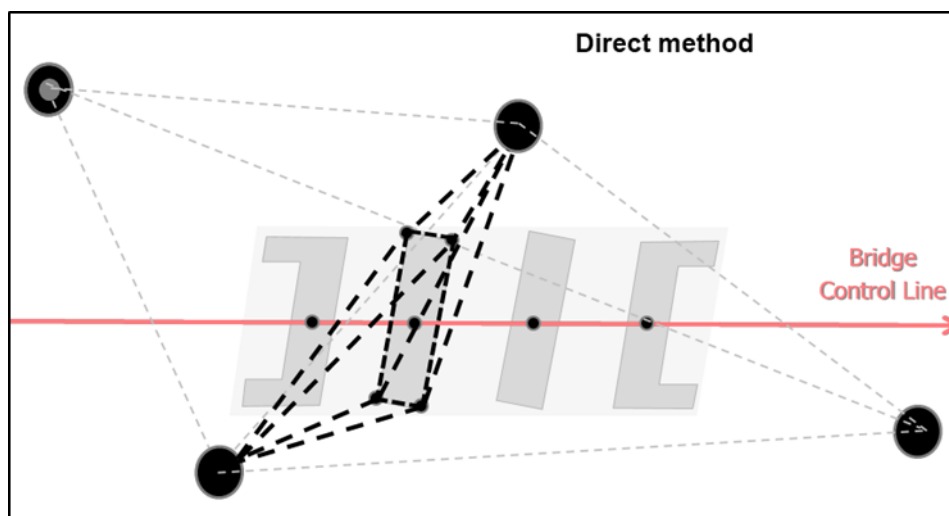

In some instances, it may only be possible to set out from the one location. In these cases, the minimum requirement is to check the external dimensions and measurements between previously set out adjacent pier headstocks or headstock and abutment as shown in Figure 6.6.8.4(b). The check dimensions between headstocks and headstock to abutment should be within double the construction tolerances.

Figure 6.6.8.4(b) – Single station setout and checks

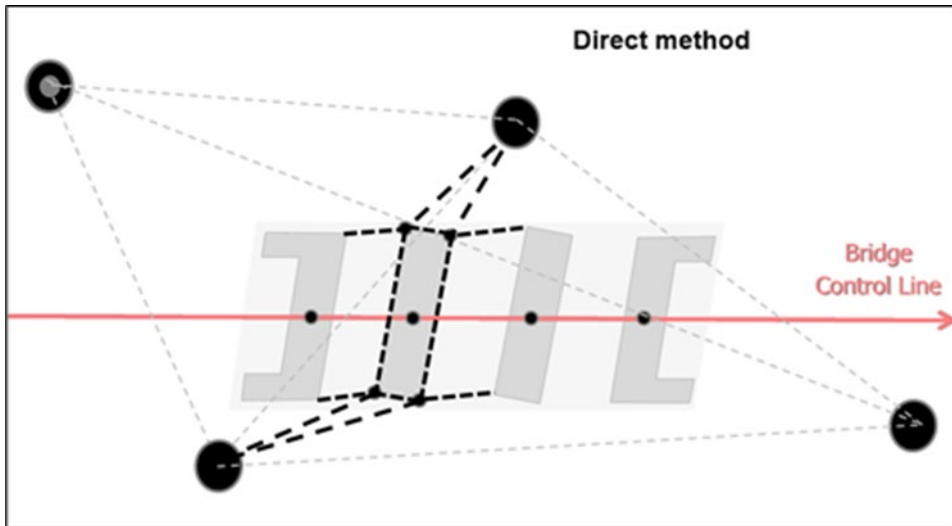

6.6.8.5 Setting out coreholes

Set out Bridge Control line and Abutment and Pier Control alignment locations (coloured red) on edges of formwork as shown in Figure 6.6.8.5. Set out Corehole locations (these usually require pre calculations from dimensional information on the construction drawings) on edges of formwork as shown in Figure 6.6.8.5. Check all internal dimensions as shown in Figure 6.6.8.5. Check measurements should be within +/- 3 mm of calculated dimensions.

Figure 6.6.8.5 – Corehole setout

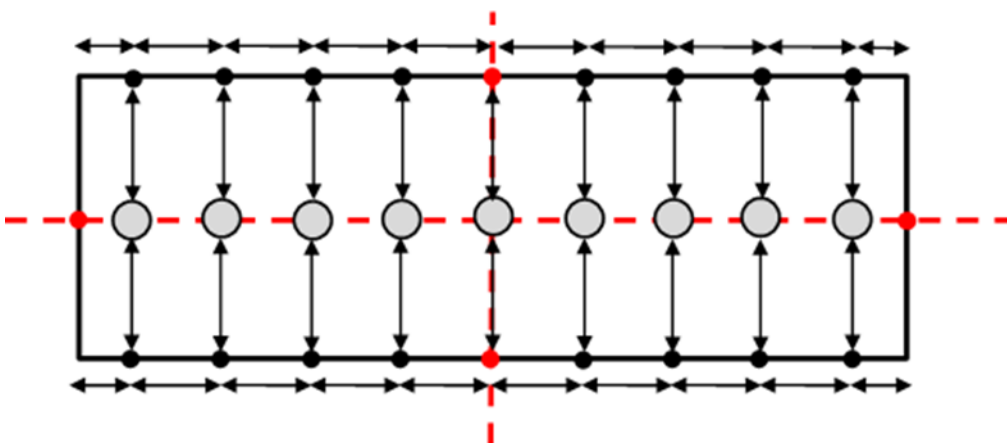

6.6.9 As Constructed Survey

For all As Constructed Survey requirements, refer to MRTS56 *Construction Surveying*.

6.6.9.1 Certification Requirement

The certification requirement must be signed by a Surveyor who meets the competency requirements for the relevant categories of bridge construction setting out as specified in Section 2.4.3 of *Part 1 – General Information and* should contain the following or similar wording:

I hereby certify that the vertical and horizontal locations, and dimensions directly measured by me and shown on this plan or electronic file outputs (as delivered) are a true and correct record of the As Constructed Survey information

Signed Dated.....

..... (Accreditation)

6.6.10 Deliverables

For deliverables, refer to MRTS56 *Construction Surveying*.

6.6.11 Bridge Survey Control Accepted Practices

The following are accepted practices that are based on sound proven practice that if adopted, will meet the requirements of Section 6.6.3 of this document.

6.6.11.1 Bridge survey control network

There is no hard and fast rule as to which Project Survey Control mark should be adopted as the hold mark. For a simple small bridge structure, the hold mark could be one of the existing original survey control marks close to the end of the proposed new bridge (see Figure 6.6.11.1(a)). In this scenario, any lateral shift between the bridge control line and the road control would be insignificant.

Figure 6.6.11.1(a) – Bridge survey control network

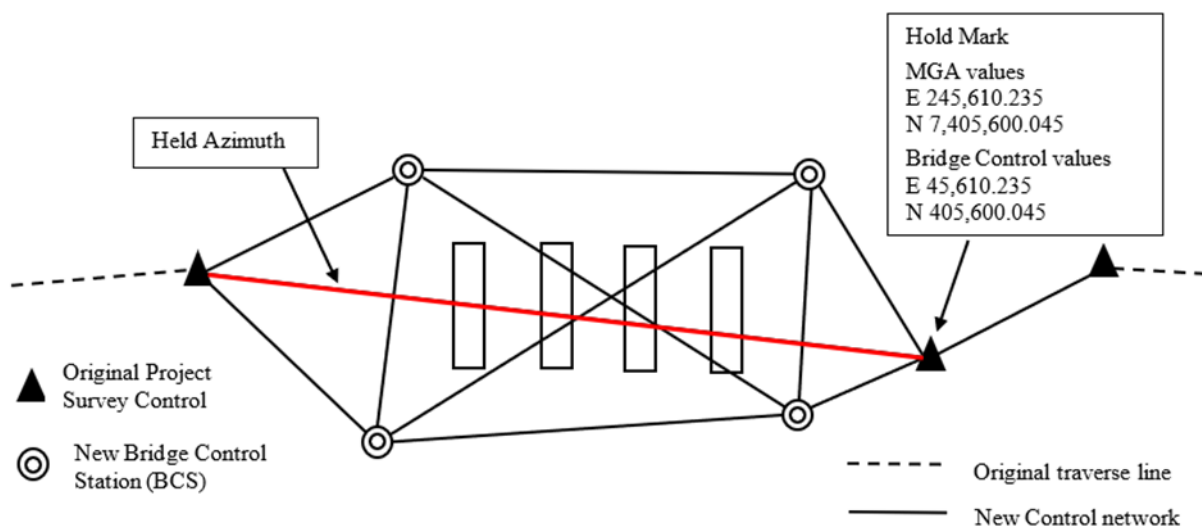

An alternative to the previous example is to hold a virtual mark at the bridge centroid (see Figure 6.6.11.1(b)).

Figure 6.6.11.1(b) – Bridge survey control virtual mark

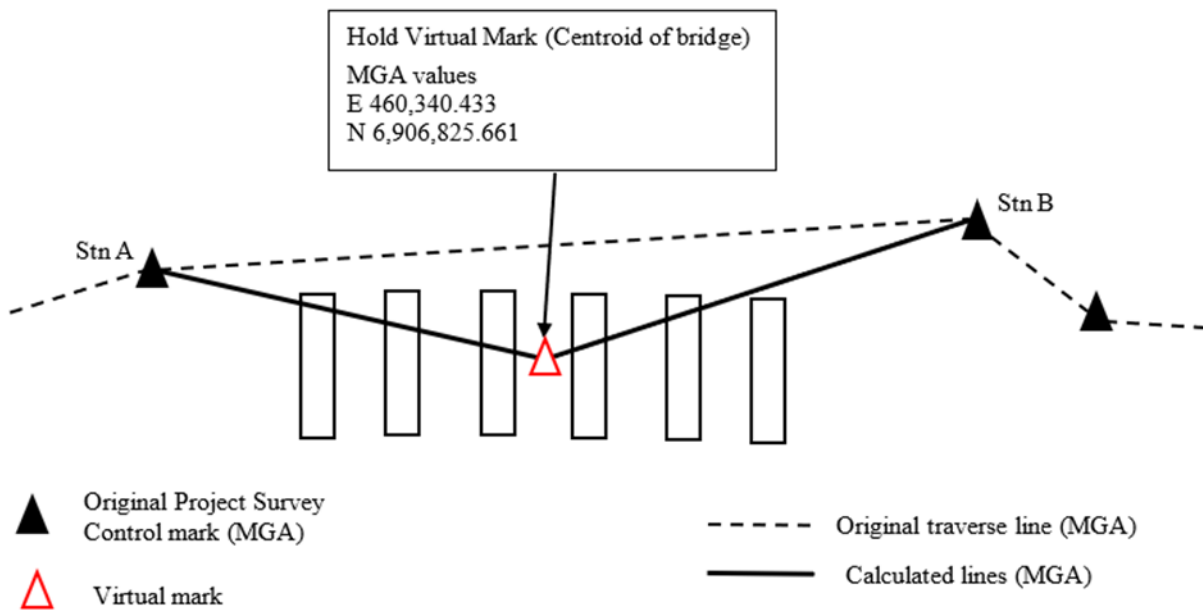

Delete the first digit from the GDA2020 / MGA zone 5* Easting and Northing coordinates to establish Bridge Control coordinate values. Recalculate coordinates of original stations at either end of the bridge (Stn A & Stn B) by holding calculated GDA2020 / MGA zone 5* bearings from the Virtual centroid mark to these marks and applying scale factor correction to obtain ground (plane) distances. Rename these marks Stn A¹ and Stn B¹ (See Figure 6.6.11.1(c)). The original station marks are now in the same terms as the centroid plane coordinates. This eliminates any slight (in the order of 10 mm to 15 mm) horizontal bridge centreline shift relative to the road centreline compared to the previous example.

Figure 6.6.11.1(c) – Datum establishment

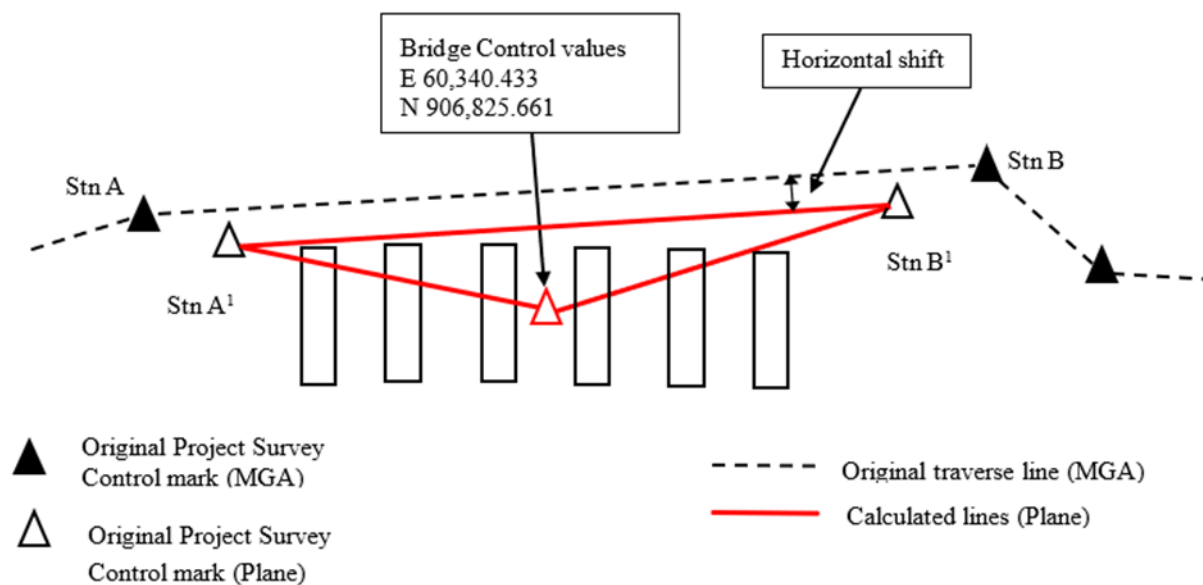

A braced network can now be adjusted using a minimally constrained least squares adjustment by holding the previously calculated plane coordinates of Stn A¹ and the calculated azimuth between Stn A¹ and Stn B¹ as shown in Figure 6.6.11.1(d).

Figure 6.6.11.1(d) – Least squares adjustment

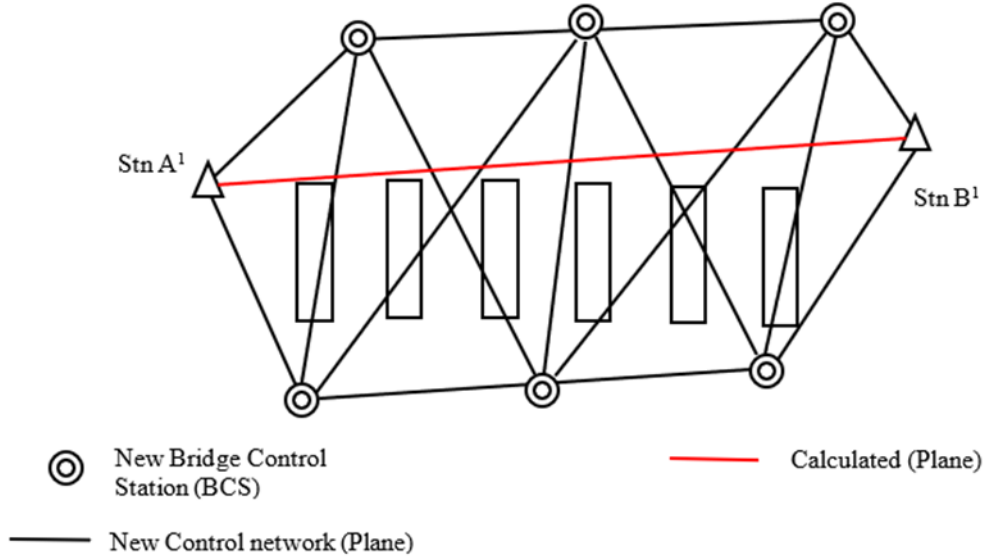

Holding the virtual hold mark at the bridge centroid also equalises the amount of shift between the bridge abutments (see Figure 6.6.11.2(a) and Figure 6.6.11.2(b)).

6.6.11.2 Impact with road earthworks

Where the scale factor is less than 1 for road construction, and the bridge is constructed using ground (plane) distances, the constructed bridge will appear shorter relative to the road construction. Extra earthworks will be required at the abutments as shown in Figure 6.6.11.2(a). For short to medium span bridges (100 m or less) this effect will be negligible.

Where the scale factor is greater than 1 for road construction, and the bridge is constructed using ground (plane) distances, the constructed bridge will appear longer relative to the road construction. Less earthworks will be required at the abutments as shown in Figure 6.6.11.2(b). For short to medium span bridges (100 m or less) this effect will be negligible.

Figure 6.6.11.2(a) – Effect of differing scale factors (1 & <1)

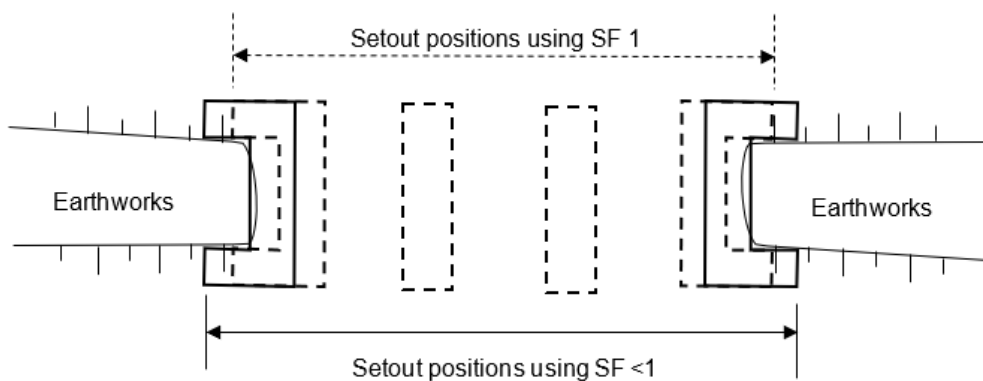
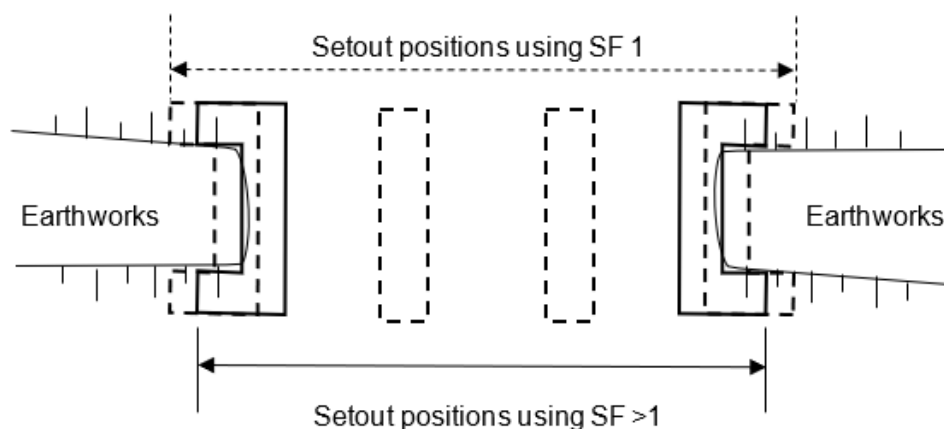

Figure 6.6.11.2(b) – Effect of differing scale factors (1 & >1)

6.7 Underground Assets

6.7.1 Introduction

Works involving the installation of new or relocated underground assets commonly occur during construction Works. New or relocated underground assets can involve three phases of surveying:

- a) Setting out
- b) Conformance (Quality Control), and
- c) As Constructed Survey

6.7.2 Training and accreditation

Where applicable, all personnel undertaking underground asset investigation must be trained and currently accredited in accordance with the requirements of the owners of underground assets. This may include restrictions by the asset owner on lifting inspection lids. All personnel entering pits and other confined spaces must be trained and accredited in confined spaces at the time of survey.

6.7.3 Setting out

Underground asset designs can be:

- a) Three dimensional (3D) Geometric designs, or
- b) Two dimensional (2D) Schematic designs

Three dimensional (3D) Geometric designs

Three dimensional (3D) Geometric designs accurately define the geospatial location and shape of an object to be constructed. These assets are required to be set out to tolerance requirements specified in relevant contract Specifications and/or to the department's Technical Specification documents. The department's Technical Specification documents can be found in *Specifications: Category 3 - Roadworks, Drainage, Culverts and Geotechnical* section.

Two dimensional (2D) Schematic designs

Two dimensional (2D) Schematic designs use abstract linework and graphic symbols to illustrate approximate spatial location only. With the exception of road crossings, these designs are usually contained within spatially defined allocated corridors (See Figure 6.7.3(a)). Setting out of 2D Schematic designs may include:

- a) Setting out allocated corridors (see Figure 6.7.3(a))
- b) Setting out design surface heights and design subgrade surface heights (See Figure 6.7.3(a) and Figure 6.7.3(b)).
- c) Setting out the extent of geometric design detail to avoid potential clashes (See Figure 6.7.3(c)).

Figure 6.7.3(a) – Cross Section View

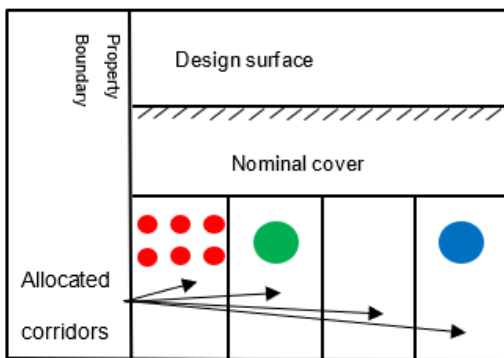

Figure 6.7.3(b) – Cross Section View

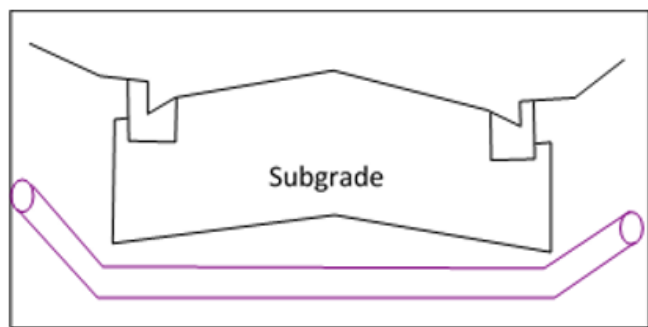

Figure 6.7.3(c) – Plan View

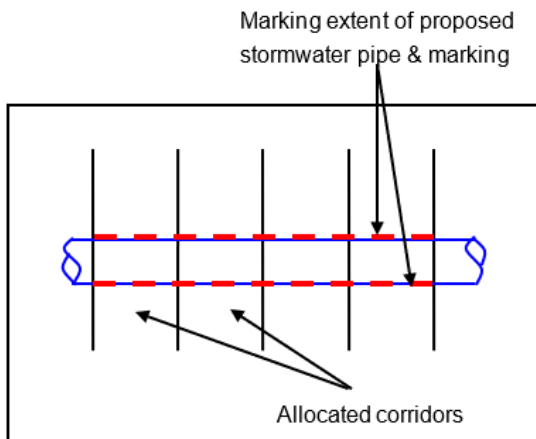
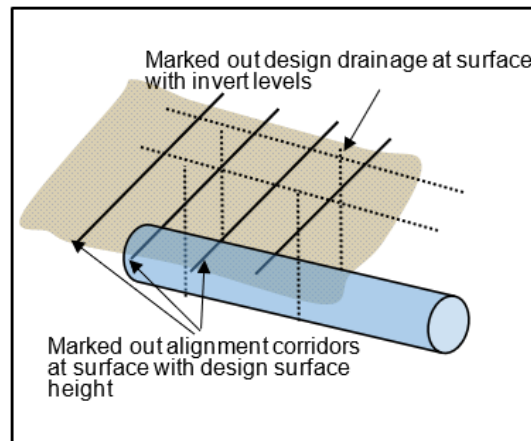

Figure 6.7.3(d) – 3D View



6.7.4 Conformance (Quality Control)

When required, conformance checks are carried out by a Surveyor on newly constructed or relocated assets prior to backfill to ensure the following:

- a) Construction tolerances have been met for a 3D Geometric design.
- b) For 2D Schematic designs.
 - i. Asset is contained within the allocated corridor and constructed at the minimum depth below design surface height. (refer Figure 6.7.4(b)).

Figure 6.7.4(a) – Nonconformance

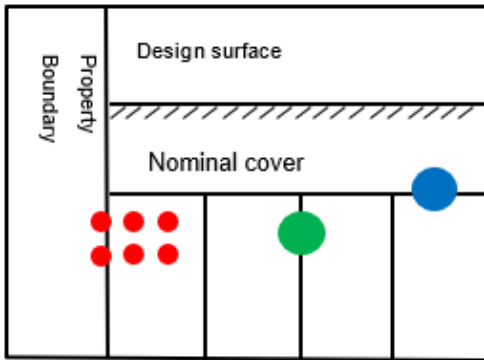
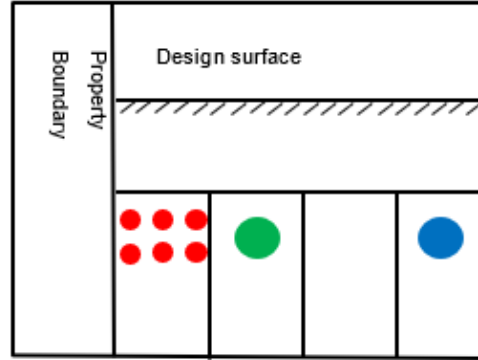

Figure 6.7.4(B) – Conformance



- ii. Asset is constructed at minimum depth below design subgrade height (refer Figure 6.7.4(d)).

Figure 6.7.4(c) – Nonconformance

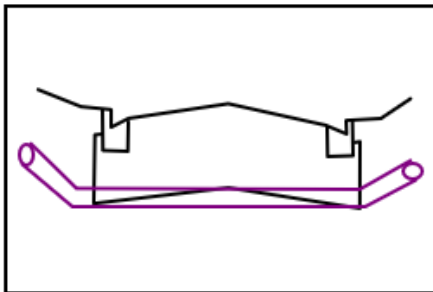
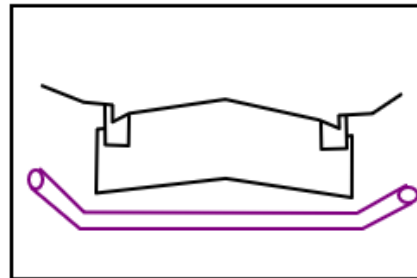

Figure 6.7.4(d) – Conformance



- iii. Asset not clash with future construction of geometrically designed assets such as gravity drainage (refer Figure 6.7.4(f)).

Figure 6.7.4(e) – Nonconformance

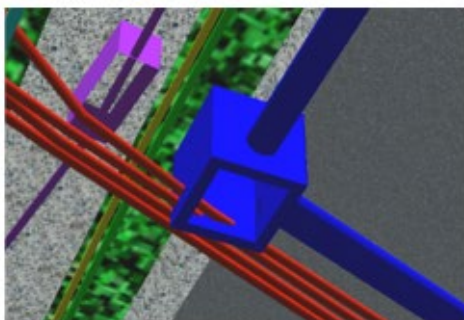
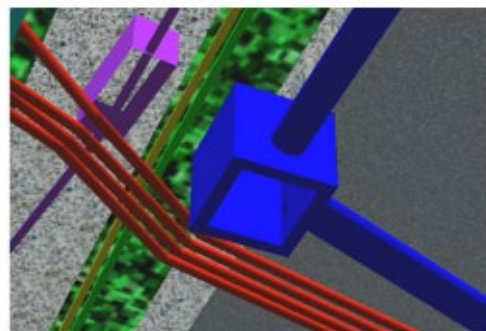

Figure 6.7.4(f) – Conformance



6.7.5 As Constructed Surveyed

The As Constructed survey is a feature model survey for the specific purpose of recording the spatial location, size, shape and any other relevant attribute data of new & relocated underground asset installations within the construction area. As such they should follow the general principles set out in Section 1 Ground and Feature Model Surveys and applicable specifics of Section 1.7 of this document. These Works can be carried out concurrently with conformance Works.

- a) The As Constructed survey must capture the horizontal and vertical locations of all newly constructed or relocated underground assets within the site boundaries including any Works outside the Site managed by the Contractor.
- b) All newly installed underground assets shall be surveyed prior to backfilling at every change in direction (both horizontally and vertically) at sufficient intervals of discrete points to achieve an interpolated horizontal and vertical accuracy in terms of Relative Uncertainty of +/- 25 mm within the project survey control network. These intervals should not exceed 5 m for flexible conduits and 10 metres for rigid pipes. For curves, sufficient intervals are required to show a reasonably shaped curve, so that the arc to chord distance is no greater than 50 mm. Discrete point accuracies must meet the requirements specified for service utilities under Sections 1.3.1.4(a) and (b) of this document.
 - i. For non-trench laid services (for example, boreholed), location should be captured by cable location (or other geophysical means) methodology.
- c) The Surveyor shall obtain records (logs, profiles etc.) from the Contractor relating to all tunnel boring that is undertaken.
- d) Location and attribute capture of all joins is required for water and gas mains. The location & dimensions of stormwater pipe collars also shall be captured.
- e) The position of each individual conduit within a multi-pipe bank is to be recorded. Where a direct measurement cannot be taken on top of a conduit, an offset depth dimension can be added to the pole height and captured on the conduit directly above.
- f) All newly installed or relocated underground assets such as conduits, pipes, reinforced concrete box units, inspection boxes, manholes, and gully boxes are to be surveyed such that recorded information includes diameters / dimensions and pipe / box wall thickness dimensions where possible. These dimensions are to be sufficient to enable the actual size and shape to be represented if required.
- g) All newly installed drainage and gravity sewer Works shall be surveyed to capture the horizontal location and height at all inlet and outlet inverts.
- h) If unable to directly measure the depth of 'cast-insitu' footings, such as light pole footings, the design depth shall be used with the attribute wording 'design depth adopted'. The design depth should be obtained from the approved design drawings or from the site Construction Supervisor.
- i) Attribute information on the located points shall include:
 - i. asset owner
 - ii. the asset type
 - iii. date of installation

- iv. date of capture
- v. asset material
- vi. size
- vii. Location, for example, invert / obvert, top of pipe and so on, and
- viii. Status: for example, "In service"

6.7.5.1 As Constructed Survey Model

The position of all points located during the As Constructed survey are to be supplied as digital data using the department coding, models and linestyles as prescribed in *Schedule 1* of the current department Surveying Standards. As Constructed survey data is to be supplied in 12d archive format.

When directed to by the Contract, survey brief or Site Engineer, three dimensional (3D) shapes of the assets will be created. 3D shapes of real world objects are only to be created when dimensions have been validated by sufficient measurements with the exception of 'cast-insitu footings as described in Section 6.7.5 (h) in this document.

6.7.5.2 Thrust blocks

Pressurised water main reticulation usually require thrust blocks wherever there is a change in water flow direction or a change in water pressure. These can be at horizontal and vertical bends, tee junctions and reducing tapers. They are usually cast Insitu against the undisturbed side of the trench. The excavated side or bottom of trench will usually be irregular in shape.

The approximate shape of the side and bottom of trench should be surveyed prior to the concrete pour. The final surface shape of the thrust block is to be surveyed once the concrete pour has been completed.

6.7.6 Abandoned and disused or retired underground services and assets left insitu

In cases where services or assets are abandoned, disused or retired and left in-situ the Asset owner is responsible for assessing the current status. The Surveyor must obtain and supply authenticated documentation from the asset owners. Where applicable this information should be attributed to the located point.

6.7.7 Certification requirement

The certification requirement must be signed by a Surveyor that meets the competency requirements for the relevant categories of road construction as specified in Section 2.4.3 of *Part 1 – General Information* and should contain the following or similar wording:

I, hereby certify that the vertical and horizontal locations and dimensions shown on this plan or as delivered electronic file outputs are directly measured by me or under my direct supervision.

Signed Dated.....
.....(Accreditation)

6.7.8 Deliverables

For deliverables, refer to MRTS56 *Construction Surveying*.

